

Instruction Manual

Self-Contained, Photoelectric Sensors in Universal-Style Housing



- Advanced one-piece photoelectric sensors with exceptional long-range optical performance
- Compact housing with mounting versatility via its popular 30 mm threaded barrel or side-mount holes
- 24 V to 250 V ac (50 Hz/60 Hz) and 12 V to 250 V dc operation with SPDT electromechanical relay output
- Tough ABS/polycarbonate blend housing is rated to IEC IP67, NEMA 6
- Easy-to-see sensor status indicators: two status LEDs visible from 360°; extra large Output indicator on the back of the sensor housing (except emitters) visible from long distances
- Opposed, polarized retroreflective, and fixed-field (200 mm, 400 mm, or 600 mm cutoff) models available
- 2 m integral cable and 152 mm quick-disconnect cable options



WARNING:

- **Do not use this device for personnel protection**
- Using this device for personnel protection could result in serious injury or death.
- This device does not include the self-checking redundant circuitry necessary to allow its use in personnel safety applications. A device failure or malfunction can cause either an energized (on) or de-energized (off) output condition.

Models

Sensing Mode	Model	Range	LED	Output
<p>OPPOSED</p>	QS303E Emitter	60 m (200 ft)	Infrared, 875 nm Effective Beam: 18 mm (0.7 in)	-
	QS30VR3R Receiver	60 m (200 ft)		
<p>POLAR RETRO</p>	QS30VR3LP	8 m (26 ft) ²	Visible red, 630 nm	SPDT
<p>FIXED-FIELD</p>	QS30VR3FF200	200 mm (7.9 in)	Visible red, 680 nm	
	QS30VR3FF400	400 mm (15.7 in)		
	QS30VR3FF600	600 mm (23.6 in)		

Fixed-Field Mode Overview

QS30 self-contained fixed-field sensors are small, powerful, infrared diffuse mode sensors with far-limit cutoff (a type of background suppression). Their high excess gain and fixed-field technology allow detection of objects of low reflectivity, while ignoring background surfaces.

The cutoff distance is fixed. Backgrounds and background objects must always be placed beyond the cutoff distance.

¹ Standard 2 m (6.5 ft) cable models are listed.

- For 9 m (30 ft) integral cable: add suffix "W/30" (for example, QS303E W/30).
- 5-pin Micro-style 152 mm (6 in) cable: add "QPMA" (for example, QS303EQPMA).

² Range is measured using a model BRT-84 retroreflector.



Fixed-Field Sensing – Theory of Operation

The QS30FF compares the reflections of its emitted light beam (E) from an object back to the sensor's two differently aimed detectors, R1 and R2. See [Figure 1](#) on p. 2. If the near detector's (R1) light signal is stronger than the far detector's (R2) light signal (see object A in the Figure below, closer than the cutoff distance), the sensor responds to the object. If the far detector's (R2) light signal is stronger than the near detector's (R1) light signal (see object B in the Figure below, beyond the cutoff distance), the sensor ignores the object.

The cutoff distance for the QS30 is fixed at 200 mm, 400 mm, or 600 millimeters (8 in, 16 in, or 24 in). Objects lying beyond the cutoff distance are usually ignored, even if they are highly reflective. However, under certain conditions, it is possible to falsely detect a background object (see [Background Reflectivity and Placement](#) on p. 2).

Figure 1. Fixed-Field Concept

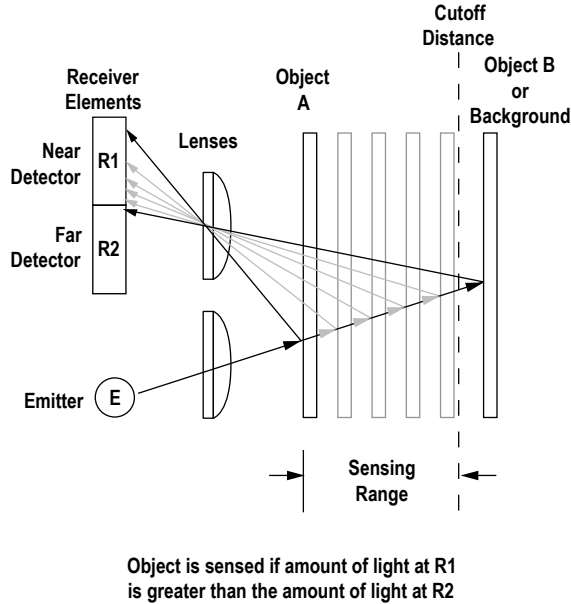
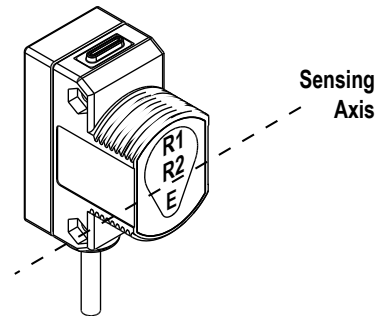

Figure 2. Fixed-Field Sensing Axis



In the drawings and information provided in this document, the letters E, R1, and R2 identify how the sensor's three optical elements (Emitter "E", Near Detector "R1", and Far Detector "R2") line up across the face of the sensor. The location of these elements defines the sensing axis, see [Figure 2](#) on p. 2. The sensing axis becomes important in certain situations, such as those illustrated in [Figure 5](#) on p. 3 and [Figure 6](#) on p. 3.

Device Setup

Sensing Reliability

For highest sensitivity, position the target for sensing at or near the point of maximum excess gain. See Performance Curves section for excess gain curves. Sensing at or near this distance makes the maximum use of each sensor's available sensing power. The background must be placed beyond the cutoff distance. Note that the reflectivity of the background surface also may affect the cutoff distance. Following these guidelines improves sensing reliability.

Background Reflectivity and Placement

Avoid mirror-like backgrounds that produce specular reflections. A false sensor response occurs if a background surface reflects the sensor's light more to the near detector (R1) than to the far detector (R2). The result is a false ON condition ([Figure 3](#) on p. 2). Correct this problem by using a diffusely reflective (matte) background, or angling either the sensor or the background (in any plane) so the background does not reflect light back to the sensor ([Figure 4](#) on p. 2). Position the background as far beyond the cutoff distance as possible.

An object beyond the cutoff distance, either stationary (and when positioned as shown in [Figure 5](#) on p. 3), or moving past the face of the sensor in a direction perpendicular to the sensing axis, may cause unwanted triggering of the sensor if more light is reflected to the near detector than to the far detector. Correct the problem by rotating the sensor 90° ([Figure 6](#) on p. 3). The object then reflects the R1 and R2 fields equally, resulting in no false triggering. A better solution, if possible, may be to reposition the object or the sensor.

Figure 3. Reflective Background - Problem

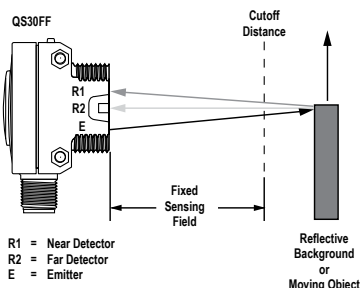

Figure 4. Reflective Background - Solution

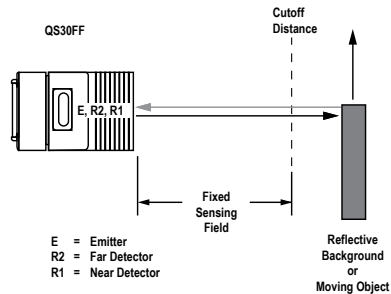
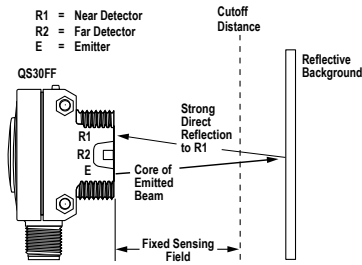
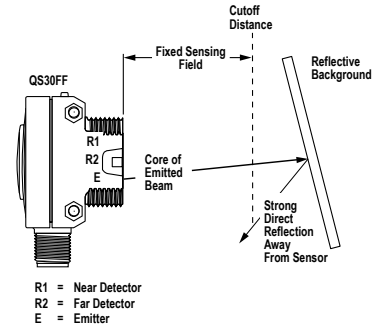

Figure 5. Object Beyond Cutoff - Problem



A reflective background object in this position or moving across the sensor face in this axis and direction may cause a false sensor response.

Figure 6. Object Beyond Cutoff - Solution



A reflective background object in this position or moving across the sensor face in this axis is ignored.

Color Sensitivity

The effects of object reflectivity on cutoff distance, though small, may be important for some applications. It is expected that at any given cutoff setting, the actual cutoff distance for lower reflectance targets is slightly shorter than for higher reflectance targets. This behavior is known as color sensitivity.

For example, an excess gain of 1 for an object that reflects 1/10 as much light as the 90% white card is represented by the horizontal graph line at excess gain = 10. An object of this reflectivity results in a far limit cutoff of approximately 190 mm (7.5 in) for the 200 mm (8 in) cutoff model, for example; and 190 mm represents the cutoff for this sensor and target.

These excess gain curves were generated using a white test card of 90% reflectance. Objects with reflectivity of less than 90% reflect less light back to the sensor, and thus require proportionately more excess gain in order to be sensed with the same reliability as more reflective objects. When sensing an object of very low reflectivity, it may be especially important to sense it at or near the distance of maximum excess gain.

Wiring Diagrams

Cabled Emitters

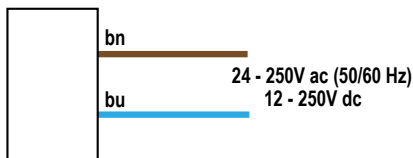

Other Cabled Models

Cable and QPMA hookups are functionally identical.

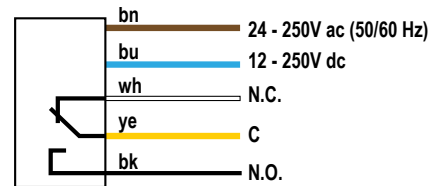

Specifications

Supply Voltage

Universal Voltage: 24 V to 250 V ac (50 Hz/60 Hz) or 12 V to 250 V dc (1.0 watt maximum)

Supply Protection Circuitry

Protected against transient voltages

Output Configuration

SPDT (Single-Pole Double-Throw) electromechanical relay output (all models except emitters)

Output Rating

Max. Switching Power (resistive load): 150 W, 1250 VA
Max. Switching Voltage (resistive load): 250 V ac; 125 V dc
Max. Switching Current (resistive load): 5 A at 250 V ac; 5 A at 30 V dc derated to 200 mA at 125 V dc
Min. Voltage and Current: 5 V dc, 10 mA
Mechanical life of relay: 50 million operations
Electrical life of relay at full resistive load: 100,000 operations

Output Response

15 milliseconds ON and OFF



Note: 100 millisecond delay on power-up; output does not conduct during this time.

Cutoff Point Tolerance

Fixed-Field Only: ± 5% of nominal cutoff distance

Indicators

Two LEDs (Green and Amber) on top of sensor

Green ON: power to sensors is ON

Amber ON: light sensed

Amber flashing: excess gain marginal (1 to 1.5 times) in light condition

Large, oval LED indicator on sensor back (except emitters)

Amber ON: normally open output is conducting

Construction

ABS housing, rated IEC IP67, NEMA 6; acrylic lens cover

Connections

2 m (6.5 in) or 9 m (30 in) 5-wire PVC cable

Operating Conditions

Temperature: -20 °C to +70 °C (-4 °F to +158 °F)
 95% at +50 °C maximum relative humidity (non-condensing)

Required Overcurrent Protection



WARNING: Electrical connections must be made by qualified personnel in accordance with local and national electrical codes and regulations.

Overcurrent protection is required to be provided by end product application per the supplied table.
 Overcurrent protection may be provided with external fusing or via Current Limiting, Class 2 Power Supply.
 Supply wiring leads < 24 AWG shall not be spliced.
 For additional product support, go to www.bannerengineering.com.

Supply Wiring (AWG)	Required Overcurrent Protection (Amps)
20	5.0
22	3.0
24	2.0
26	1.0
28	0.8
30	0.5

Certifications



Performance Curves

Table 1: *Opposed Mode Sensors*

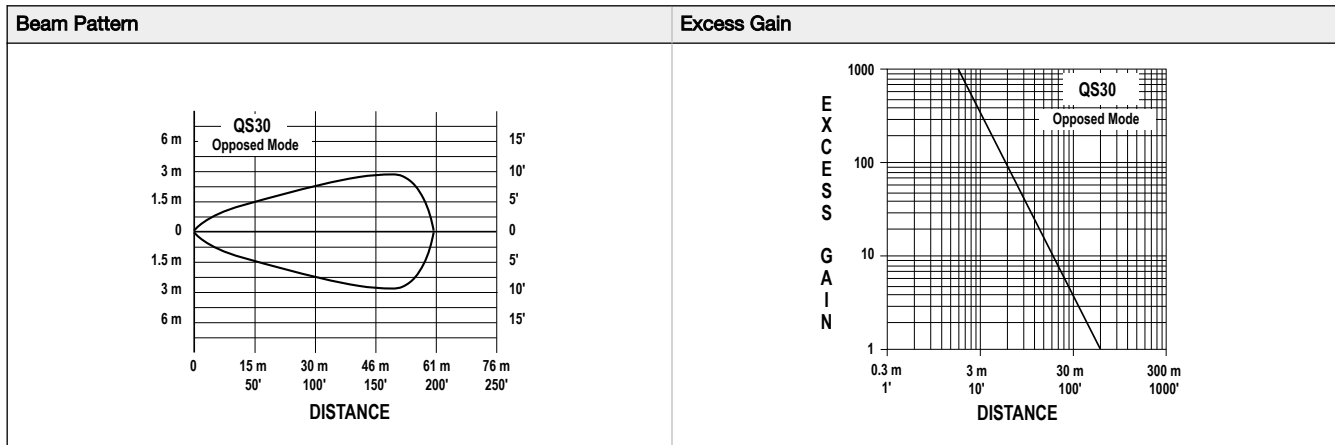

Table 2: Polarized Retroreflective Sensors³

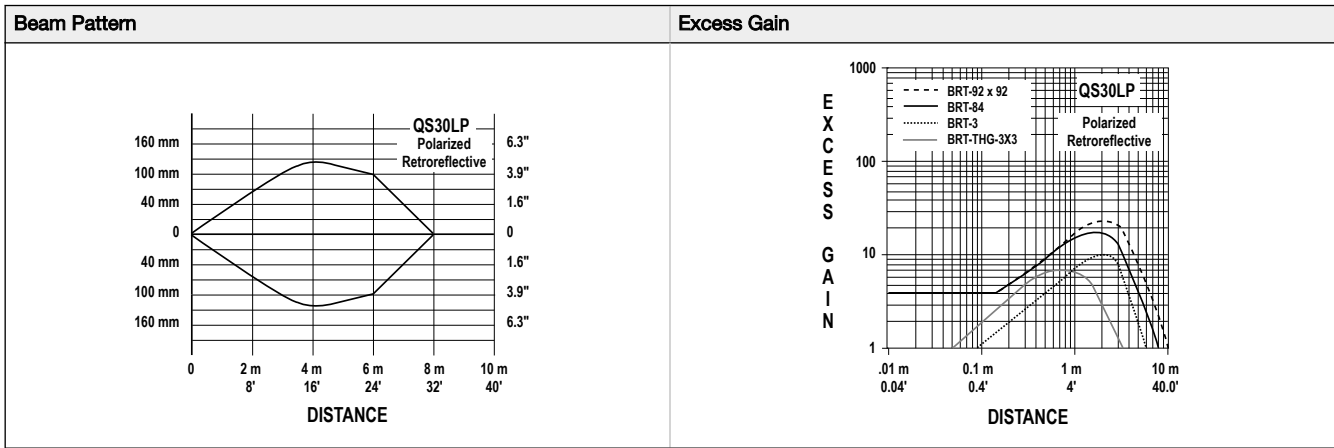
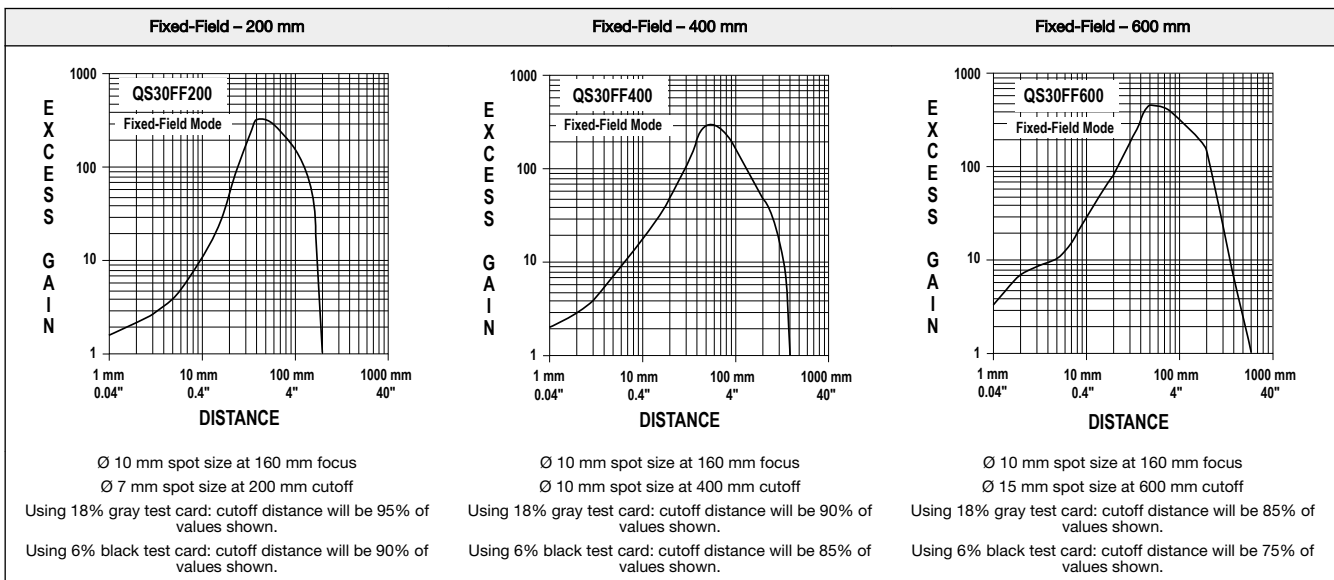
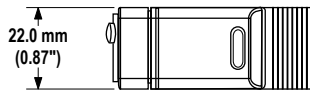

Table 3: Fixed-Field Mode Sensors Excess Gain⁴



³ Performance based on use of a model BRT-84 retroreflector. Actual sensing range may be more or less than specified, depending on the efficiency and reflective area of the retroreflector used.
⁴ Performance based on use of a 90% reflectance white test card. Focus and spot sizes are typical.

Dimensions



Hardware included:
(2) M3 x 0.5 x 28 stainless steel machine screws, nuts and washers

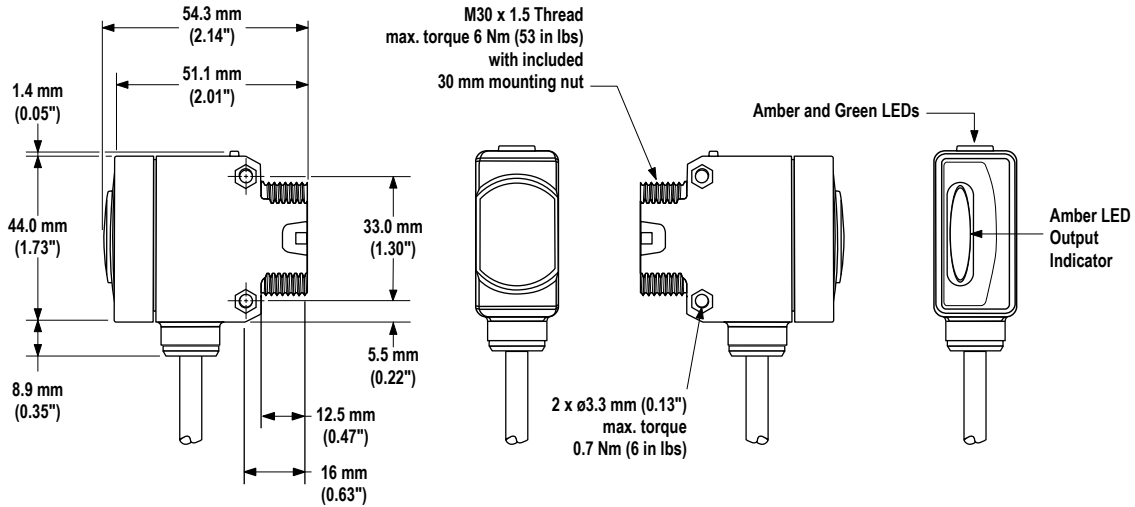

Accessories

Cordsets

5-Pin Micro-Style Cordsets—Single Ended				
Model	Length	Style	Dimensions	Pinout (Female)
MQVR3-506	2 m (6.56 ft)	Straight		<p>1 = Brown 2 = White 3 = Yellow 4 = Black 5 = Blue</p>

5-Pin Micro-Style Cordsets with Shield—Single Ended				
Model	Length	Style	Dimensions	Pinout (Female)
MQVR3S-506	2 m (6.56 ft)	Straight		<p>1 = Brown 2 = White 3 = Yellow 4 = Black 5 = Blue</p>
MQVR3S-515	5 m (16.4 ft)			
MQVR3S-530	10 m (32.8 ft)			

5-Pin Micro-Style Cordsets with Shield—Single Ended				
Model	Length	Style	Dimensions	Pinout (Female)
MQVR3S-506RA	2 m (6.56 ft)	Right Angle		
MQVR3S-515RA	5 m (16.4 ft)			
MQVR3S-530RA	10 m (32.8 ft)			

Brackets

SMBQS30L

- Right-angle bracket for cable sensor models
- Clearance for M4 (#8) hardware
- ± 12° tilt adjustment
- 14-ga. stainless steel



Hole center spacing: A to B=35.0
Hole size: A=ø 4.3, B=ø 4.25x16.3

SMB30A

- Right-angle bracket with curved slot for versatile orientation
- Clearance for M6 (¼ in) hardware
- Mounting hole for 30 mm sensor
- 12-ga. stainless steel

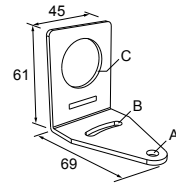

Hole center spacing: A to B=40
Hole size: A=ø 6.3, B= 27.1 x 6.3, C=ø 30.5

SMBQS30LT

- Tall right-angle bracket for QD models
- ± 8° tilt adjustment
- 14-ga. stainless steel



Hole center spacing: A to B=35.0
Hole size: A=ø 4.3, B=ø 4.25x16.3

SMB30FA

- Swivel bracket with tilt and pan movement for precise adjustment
- Mounting hole for 30 mm sensor
- 12-ga. 304 stainless steel
- Easy sensor mounting to extrude rail T-slot
- Metric and inch size bolt available

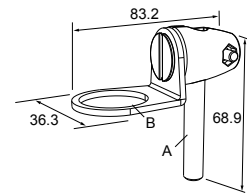

Bolt thread: SMB30FA, A= 3/8 - 16 x 2 in; SMB30FAM10, A= M10 - 1.5 x 50
Hole size: B= ø 30.1

SMB30SC

- Swivel bracket with 30 mm mounting hole for sensor
- Black reinforced thermoplastic polyester
- Stainless steel mounting and swivel locking hardware included

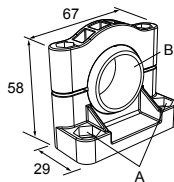

Hole center spacing: A=ø 50.8
Hole size: A=ø 7.0, B=ø 30.0

SMBAMS30RA

- Right-angle SMBAMS series bracket
- 30 mm hole for mounting sensors
- Articulation slots for 90°+ rotation
- 12-ga. (2.6 mm) cold-rolled steel

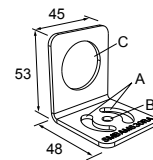

Hole center spacing: A=26.0, A to B=13.0
Hole size: A=26.8 x 7.0, B=ø 6.5, C=ø 31.0

SMB30MM

- 12-ga. stainless steel bracket with curved mounting slots for versatile orientation
- Clearance for M6 (¼ in) hardware
- Mounting hole for 30 mm sensor

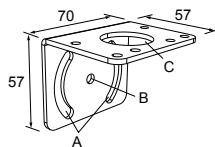

Hole center spacing: A = 51, A to B = 25.4
Hole size: A = 42.6 x 7, B = ø 6.4, C = ø 30.1

SMBAMS30P

- Flat SMBAMS series bracket
- 30 mm hole for mounting sensors
- Articulation slots for 90°+ rotation
- 12-ga. 300 series stainless steel

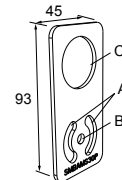

Hole center spacing: A=26.0, A to B=13.0
Hole size: A=26.8 x 7.0, B=ø 6.5, C=ø 31.0

Retroreflective Targets

See www.bannerengineering.com, for retroreflective targets.



Note: Polarized sensors require corner-cube type retroreflective targets only.

Apertures

Opposed-mode QS30 sensors may be fitted with apertures to narrow or shape the sensor's effective beam to more closely match the size or profile of the objects being sensed. A common example is the use of "line" (or "slot") type apertures to sense thread.



Note: The use of apertures reduces the sensing range.

Model	Description	Pieces	
Circular			
APQS30-040	1 mm (0.04 in) diameter	6	
APQS30-100	2.5 mm (0.10 in) diameter	6	
APQS30-200	5 mm (0.20 in) diameter	6	
Horizontal Slot			
APQS30-040H	1 x 12 mm (0.04 in x 0.47 in)	6	
APQS30-100H	2.5 x 12 mm (0.10 in x 0.47 in)	6	
APQS30-200H	5 x 12 mm (0.20 in x 0.47 in)	6	
Vertical Slot			
APQS30-040V	1 x 17 mm (0.04 in x 0.67 in)	6	
APQS30-100V	2.5 x 17 mm (0.10 in x 0.67 in)	6	
APQS30-200V	5 x 17 mm (0.20 in x 0.67 in)	6	
APQS30-DVHX2	Kit containing two of each aperture above	18	
APQS30-DVH	Kit containing one each of aperture models: APQS30-040, APQS30-040H, APQS30-040V	18	

Reduced Range for QS30E and QS30R Pair with Apertures

Aperture Model	Maximum Range	
	Aperture on Both Emitter and Receiver	Aperture on Receiver Only
APQS30-040	0.5 m (1.5 ft)	4.1 m (13.5 ft)
APQS30-100	2.4 m (8 ft)	14.3 m (47 ft)
APQS30-200	11.6 m (38 ft)	23.5 m (77 ft)
APQS30-040H	7 m (23 ft)	16.8 m (23 ft)
APQS30-100H	16.5 m (54 ft)	24.7 m (54 ft)
APQS30-200H	28.7 m (94 ft)	36.6 m (94 ft)
APQS30-040V	7 m (23 ft)	16.8 m (23 ft)
APQS30-100V	16.5 m (54 ft)	24.7 m (54 ft)
APQS30-200V	28.7 m (94 ft)	36.6 m (94 ft)

Example: The QS30E/QS30R sensor pair is used with apertures APQS30-040. Using the circular aperture on only the receiver, the range reduces to 4.1 m (13.5 ft). When the APQS30-040 aperture is installed on both the receiver and emitter, the sensor range reduces to 0.5 m (1.5 ft).

Banner Engineering Corp. Limited Warranty

Banner Engineering Corp. warrants its products to be free from defects in material and workmanship for one year following the date of shipment. Banner Engineering Corp. will repair or replace, free of charge, any product of its manufacture which, at the time it is returned to the factory, is found to have been defective during the warranty period. This warranty does not cover damage or liability for misuse, abuse, or the improper application or installation of the Banner product.

THIS LIMITED WARRANTY IS EXCLUSIVE AND IN LIEU OF ALL OTHER WARRANTIES WHETHER EXPRESS OR IMPLIED (INCLUDING, WITHOUT LIMITATION, ANY WARRANTY OF MERCHANTABILITY OR FITNESS FOR A PARTICULAR PURPOSE), AND WHETHER ARISING UNDER COURSE OF PERFORMANCE, COURSE OF DEALING OR TRADE USAGE.

This Warranty is exclusive and limited to repair or, at the discretion of Banner Engineering Corp., replacement. **IN NO EVENT SHALL BANNER ENGINEERING CORP. BE LIABLE TO BUYER OR ANY OTHER PERSON OR ENTITY FOR ANY EXTRA COSTS, EXPENSES, LOSSES, LOSS OF PROFITS, OR ANY INCIDENTAL, CONSEQUENTIAL OR SPECIAL DAMAGES RESULTING FROM ANY PRODUCT DEFECT OR FROM THE USE OR INABILITY TO USE THE PRODUCT, WHETHER ARISING IN CONTRACT OR WARRANTY, STATUTE, TORT, STRICT LIABILITY, NEGLIGENCE, OR OTHERWISE.**

Banner Engineering Corp. reserves the right to change, modify or improve the design of the product without assuming any obligations or liabilities relating to any product previously manufactured by Banner Engineering Corp. Any misuse, abuse, or improper application or installation of this product or use of the product for personal protection applications when the product is identified as not intended for such purposes will void the product warranty. Any modifications to this product without prior express approval by Banner Engineering Corp will void the product warranties. All specifications published in this document are subject to change; Banner reserves the right to modify product specifications or update documentation at any time. Specifications and product information in English supersede that which is provided in any other language. For the most recent version of any documentation, refer to: www.bannerengineering.com.

For patent information, see www.bannerengineering.com/patents.