

PA03-115VAC

Photoelectric Amplifiers

Standard, Remote Photoelectric Systems



Product Data	
Supply Voltage:	115 VAC
Housing:	11-pole DIN socket
Sensing Range:	Up to 70 meters / 230 feet
Sensitivity Adjustment:	Manual
Timer:	-
Output:	Relay and NPN

Technical Data	
Supply Voltage:	115 VAC
Current Consumption:	Max. 3.5 VA
Housing Material:	Noryl
Power On Indicator:	Green LED
Output Indicator:	Yellow LED
Hysteresis:	Approx. 45%
Voltage Tolerance:	+/- 15%
Output, Relay:	1 open / 1 closed, 250 VAC / 3A, 120 VAC / 5A
Output, transistor:	60 mA / 30 VDC
LR Sensor Failure Indicator:	Red LED
LT Sensor Failure Indicator:	Red LED
Sensor Monitor LED Drive:	Green LED on the receiver: 'Power ON' Yellow LED on the transmitter: PA 03 output activated
Response Time ton / toff, Relay:	35 ms / 35 ms
Response Time ton / toff, transistor:	25 ms / 25 ms
Signal Level Indicator:	Yellow LED
Operation Frequency, Relay:	14 Hz
Operation Frequency, Transistor:	20 Hz

Environmental Data

Operation Temperature:	-10 to +50°C / 14 to 122° F
Storage Temperature:	-40 to +80°C / -40 to 176°F
Sealing Class:	IP 40

Approvals



Wiring Diagram

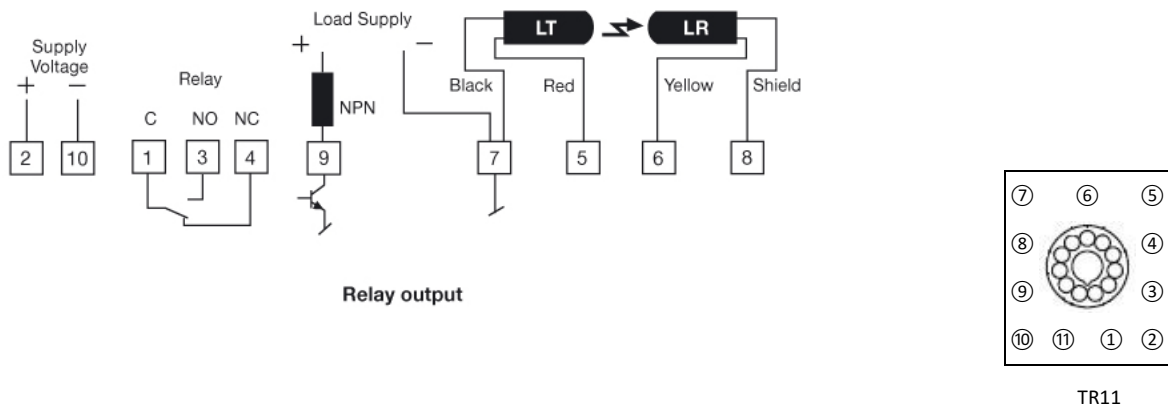

Dimensions

