

## LED 9 OPERATING AND PROGRAMMING INSTRUCTIONS

Push **S2** to change from item to item. Push **S1** to set desired value or choose option for that item. Pushing **S1** repeatedly causes numbers to increase. Holding **S1** causes numbers to decrease. The symbol  $\square$  represents a programmable digit. Default values are shown in [ ].

ITEM	DISPLAY/OPTIONS	REPRESENTS
1	COIN VALU [\$ .25]	The monetary value assigned to a single coin pulse. Adj. from \$0.05 to \$5.00
2	A : $\square\square$ [30]	Time per coin/pulse for function 1. Adj. from 0:01 to 9:59.
3	B: $\square\square$ [25]	Time per coin/pulse for function 2. Adj. from 0:01 to 9:59.
4	C: $\square\square$ [20]	Time per coin/pulse for function 3. Adj. from 0:01 to 9:59.
5	D: $\square\square$ [15]	Time per coin/pulse for function 4. Adj. from 0:01 to 9:59.
6	E: $\square\square$ [10]	Time per coin/pulse for function 5. Adj. from 0:01 to 9:59.
7	F: $\square\square$ [05]	Time per coin/pulse for function 6. Adj. from 0:01 to 9:59.
8	A $\square\square\square$ [8]	Number of coins/pulses to start for function 1. Adj. from 1 to 200.
9	B $\square\square\square$ [7]	Number of coins/pulses to start for function 2. Adj. from 1 to 200.
10	C $\square\square\square$ [6]	Number of coins/pulses to start for function 3. Adj. from 1 to 200.
11	D $\square\square\square$ [5]	Number of coins/pulses to start for function 4. Adj. from 1 to 200.
12	E $\square\square\square$ [4]	Number of coins/pulses to start for function 5. Adj. from 1 to 200.
13	F $\square\square\square$ [3]	Number of coins/pulses to start for function 6. Adj. from 1 to 200.
14	Ax. $\square\square$ [4]	Auxiliary coin/pulse input pulse multiplier. Adj from 1 to 80.
15	BONUS COIN B $\square\square\square$ [9]	Coins/Pulses to bonus. Bonus time is given when this coin/pulse is received.
16	BONUS TIME $\square\square:##$ $\square\square\square\square$ [00:00]	Amount of time added for bonus coin/pulse. Adj. from 00:00 to 59:59.
17	[SINGLE BONUS] MULTIPLE BONUS	Bonus time is only added one time when bonus coin pulse is received. Bonus time is added for every coin after bonus coin pulse is received.
18	[DEBIT MODE] CREDIT MODE BOTH	Money counts down as coins are inserted. Money count up as coins are inserted. Money counts up as coins are inserted, plus a prompt of "ADD \$X MORE" if start price is not reached.
19	[DELAYED START] INSTANT START	Two second delay before timing starts after start price is reached. Timing starts as soon as start price is reached.
20	HL $\square\square$ [10]	Length of warning horn is seconds at one minute of time remaining.

21	[PULSED HORN] CONTINUOUS HORN	Horn output will pulse for amount of time set in HL: [ ][ ] Horn output will stay on continuously for entire last minute.
22	[RESTART OFF] RESTART ON	Restart feature turned off. Full price required after time expires. Timer may be restarted with one coin for 20 seconds after time expires.
23	[STD] USER MIX	Standard greeting message is displayed. User programmed custom greeting message is displayed. Standard message then custom message is displayed.
24	M [ ][ ][ ] [5:00]	Length of washdown cycle using remote control. Adj. from 0:00 to 9:59.
25	[ ][ ][ ][ ] [1 2 3 4]	Adjustable remote access code.
26	[CC N] CC Y	Timer pin #8 functions as auxiliary input for bill validator or second coin acceptor. Timer pin #8 functions as credit card input.
27	CC PULSE VALUE \$ [ ][ ][ ] [\$ .25]	Monetary value assigned to credit card pulse received on pin #8 during count up.
28	[ENG] SPH E & S	Standard message and prompt is displayed in English. Standard message and prompt is displayed in Spanish. Standard message and prompt is displayed in English then displayed in Spanish.
24	DM [ ] [1]	Dimming mode active.
25	EXIT	Timer returns to standby.

## Inventory

Timer keeps a running count of coins deposited, auxiliary pulses and manual cycles.

To show inventory press **S1**. timer will display COINS XXXX (Number of coin pulses since last cleared), AUX XXXX ( Number of pulses on auxiliary input if step 27 is set to CC N) then MANUAL XXXX (Number of washdown cycles used since last cleared).

To clear inventory: Press **S1** to display inventory. Press and hold **S2** until display reads "CLR?". Release **S2**. Press and hold **S2** again until timer reads "DONE".

## Bonus Time Settings

Amount of time set in bonus time is added to time remaining on timer when bonus coin/pulse is received.

Bonus is disabled by setting bonus time to 00:00.

If "SINGLE BONUS" is selected, bonus time is only added once, when bonus coin/pulse is received. Any coins deposited after that bonus coin will receive the regular time per coin.

If "MULTIPLE BONUS" is selected, every coin deposited after bonus coin/pulse is reached will receive amount of time set in "BONUS TIME".

When using a function other than function 1 and bonus time is added, the amount of time that is actually added is calculated by the following equation:

$$[\text{Time Added}] = [\text{Bonus Time}] * [\text{current function time per coin}] / [\text{function 1 time per coin}].$$

### **Debit/Credit Mode:**

Debit Mode: As coins are deposited display shows "\$1.75 MORE, \$1.50 MORE, \$1.25 MORE" etc. until start price is reached. Once start price is reached display switches to time accumulating until no more coins have been deposited.

Credit Mode: As coins are deposited display shows money accumulating (\$ .25, \$ .50, \$ .75 etc.). If timer is also set to Delayed Start Mode timer will continue to show money accumulating until no more coins have been deposited. If timer is set to Instant Start mode, as soon as start price is reached, timer will change to time counting down.

Both Mode: As coins are deposited display shows money accumulating (\$ .25, \$ .50, \$ .75 etc). If start price is not reached, after 5 seconds timer will alternate between "ADD \$X.XX MORE" and amount of money already deposited.

### **Credit Card Input:**

Menu item #26 must be set to "CC Y"

Input may be used as count-up or pre-pay.

Count up mode: No pre-set amount is charged to card. Timer will count up and run until terminated by credit card system.

For count up: Close pin #8 (input) to 24 VAC common for more than 400ms. Timer will continue to count up until closure is released for more than 400ms.

To have timer display amount charged to card at end of cycle: Close input as above. Credit card system sends a string of pulses to timer equal to the number of coins that timer would require in order to reach the amount of time used when customer stops cycle.

Pre-pay mode: A pre-determined amount is charged to credit card each time card is swiped and credit card system sends pulses to input.

Pulses between 16ms and 200ms will register on timer like coin pulses.

A pulse between 200ms and 400ms will cause timer to display "VERIFYING CARD". Should a second pulse of 200ms to 400ms be received on input timer will display "TRY DIFFERENT CARD".

Minimum time between pulses is 16ms.

Note: Not all credit card systems can utilize all modes of operation. Contact your credit card system manufacturer for more information on what your system can do.

### **Dimming Mode**

The LED 9 has a unique built in dimming feature that allows the display to be as bright as possible under different lighting conditions without being uncomfortable to look at (i.e. more ambient light means brighter display, less ambient light means dimmer display).

### **Messages**

Standard greeting message (English): "PLEASE DEPOSIT \$2.00 TO START".

Standard greeting message (Spanish): "POR FAVOR DEPOSITO \$2.00 PARA EMPEZAR"

Standard exit message (English): "THANK YOU"

Standard exit message (Spanish): "GRACIAS"

### **Custom Message Programming:**

A custom message can be programmed up to 64 characters ( a space counts as a character).

To program a custom message: Push **S2** until STD appears on display. Push **S1** until USER appears on display. Push and hold **S2** until “/” appears on right side of display. Push **S1** until first letter of your custom message appears on right side of display. Push **S2** . The first letter of your message will move over one position to the left and an “A” will appear on the far right. Push **S1** until the second letter of your message appears on the right. Continue in this fashion until you message is complete. ( Push **S2** to advance to the next space in your message, push **S1** to display the letter or character you need. The character you are programming will always be the far right digit.) At the end of your message you MUST put a “/” to indicate the end of the message. Once your message is complete, push and hold **S2** until USER appears on the display. Push **S2** until EXIT appears. Message programming is now complete.

### **Count Up Message:**

During count up mode an operator programmable message of up to 31 characters can be displayed every twenty seconds. To program message push and hold **S2** when timer is displaying “CC Y” until “ / ” appears on display, then proceed as above, use **S1** to set letter or character required then press **S2** to advance to next space. When message is complete, hold **S2** until timer shows “DONE”.

### **Multi-Function Messages:**

A custom message of up to 32 characters may be programmed for each of the six functions.

When in standby and that function is selected, the timer will display the custom message and then the standard message. When timer is counting down and a different function is selected, timer will display the custom message and then display the time remaining.

To program a custom message for any of the six functions: Press **S2** until time per coin for that function is displayed. Press and hold **S2** until “/” appears on display, then proceed as above, use **S1** to set letter or character required then press **S2** to advance to next space. When message is complete, hold **S2** until timer shows “DONE”.

### **Multi-Function Inputs:**

To display time or price set for function 1: No voltage is applied to any input pins.

To display time or price set for function 2: Apply 24 vac hot to input pin 9

To display time or price set for function 3: Apply 24 vac hot to input pin 10.

To display time or price set for function 4: Apply 24 vac hot to input pins 9 and 10.

To display time or price set for function 5: Apply 24 vac hot to input pin 11.

To display time or price set for function 6: Apply 24 vac hot to input pins 9 and 11.

## TIMER WIRING

PIN #	FUNCTION
1	Coin Common
2	Coin Switch
3	12 VDC Out
4	Horn Negative
5	Horn Positive (12 VDC)
6	24 VAC Common
7	24 VAC Hot
8	Count UP
9	Function Input
10	Function Input
11	Function Input
12	24 VAC Timed Load

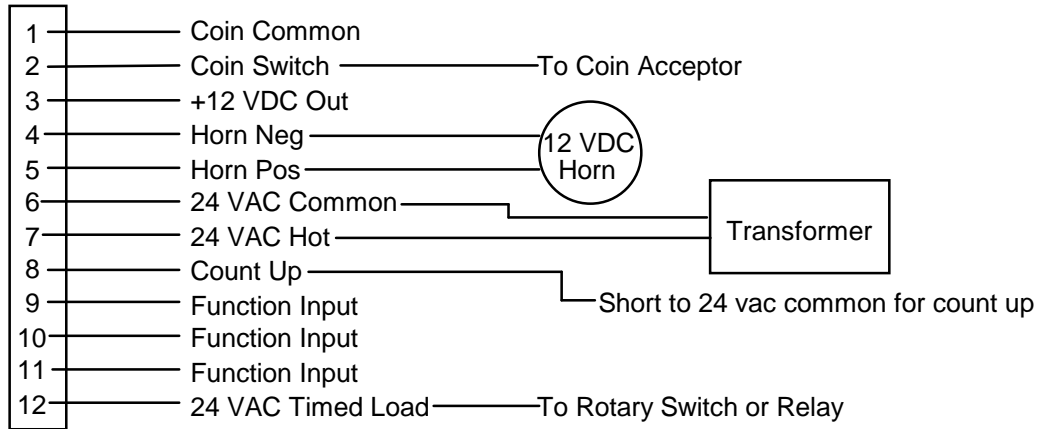

## COIN ACCEPTOR WIRING

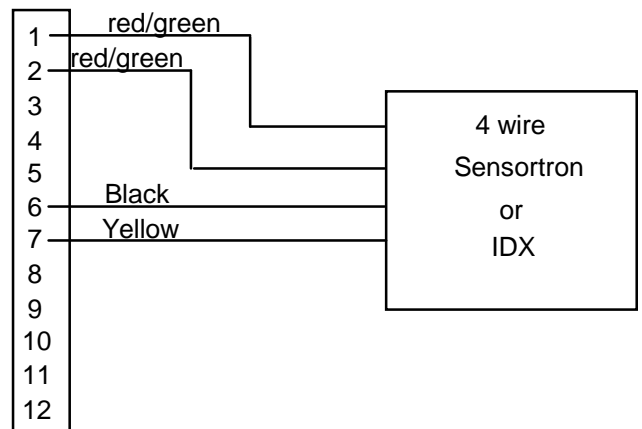
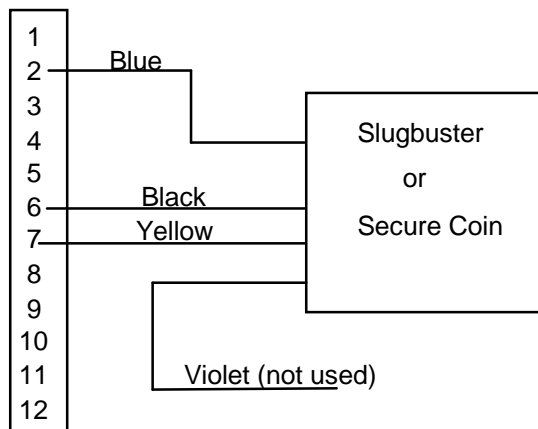



## REMOTE CONTROL

### Remote Control Operation

Remote control will hold program setup for 15 minutes without batteries to allow you to change batteries without reprogramming remote. If remote loses its program for any reason use the following instructions.

1. Hold down the set button until the red LED blinks twice, then release the button.
2. Enter **0000**

**Wash Down:** Press red power button . Display will show **0000**. Enter your four digit access Code (Default is 1 2 3 4). Timer will show **OK** if code is correct.

Press red power button  on remote control. Timer will display **M0:00** and start counting up. Timer will continue to run until washdown cycle length is reached or washdown cycle is stopped by operator. Note: To stop washdown cycle press red power button .

**Inventory:** Press red power button . Display will show 0000. Enter your four digit access code (Default is 1 2 3 4).

Timer will show **OK** if code is correct. Press  on remote control.

Timer will show **COINS 0000 AUX 0000 MANUAL 0000**. Press  again to return to standby message. Coins represents coins deposited. Manual represents the number of washdown cycles.



To clear inventory: With inventory showing, press and hold  until



**CLR?** appears on timer. Press and hold  again until **DONE** appears on timer. Inventory has now been reset to zero. Clearing inventory resets both coins and manual to zero.

Press  to return to standby.



**Timer Programming:** Press red power button . Timer will show **0000**. Enter four digit access code (Default is 1 2 3 4).

Timer will show **OK** if code is correct.

Press . Timer will display **COIN VALU \$ .25**. Use  or  to set monetary value of one coin pulse.

Press  to advance to next item. Use  or  to set value or make choice for that item.

Continue in this manner until all modes have been programmed .

Use  to move to the next mode. Use  or  to set required value .

Remote control access will automatically become disabled when no buttons have been pushed for approximately one minute.