

## CAT PUMPS® CERAMIC PLUNGER PUMPS

THESE PUMPS ARE ROHS COMPLIANT

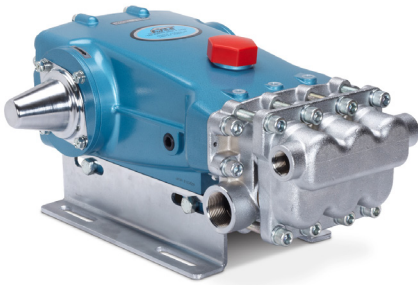

**2530**  
CAT PUMPS CERAMIC PLUNGER PUMPS



- FLOW: 25 GPM
- PRESSURE: 100 - 1200 PSI
- RPM: 1025 RPM
- HP: 20.5

**\$3,736.58** PU02530

**2530 KITS**  
CAT PUMPS CERAMIC PLUNGER PUMPS

PART #	DESCRIPTION	KITS NEEDED
PU33952	Valve Kit	x 2
PU30952	Seal Kit	x 1
PU30614	Pump Rails	-

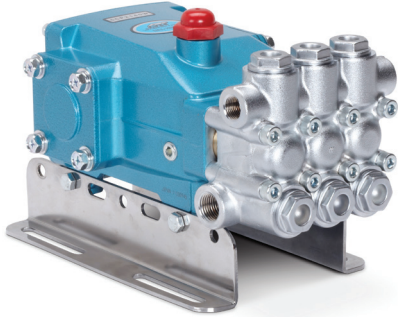

**5CP2140WCS3 DIRECT DRIVE**  
CAT PUMPS CERAMIC PLUNGER PUMPS



- FLOW: 4.0 GPM
- PRESSURE: 100 - 2500 PSI
- RPM: 1725 RPM
- HP: 6.9

**\$839.17** PU5CP2140WCS3

**5CP2140WCS3 KITS**  
CAT PUMPS CERAMIC PLUNGER PUMPS

PART #	DESCRIPTION	KITS NEEDED
PU30821	Valve Kit	x 2
PU31638	Seal Kit (high temp)	x 1
PU08230	Flex Coupler 20MM x 1½"	-
PU76184.5CP	Bell Housing	-

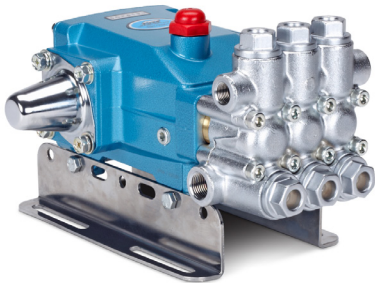

**5CP6190 DIRECT DRIVE**  
CAT PUMPS CERAMIC PLUNGER PUMPS



- FLOW: 10.0 GPM
- PRESSURE: 100 - 1200 PSI
- RPM: 1750 RPM
- HP: 8.2

**\$839.17** PU5CP6190

**5CP6190 KITS**  
CAT PUMPS CERAMIC PLUNGER PUMPS

PART #	DESCRIPTION	KITS NEEDED
PU34920	Valve Kit	x 2
PU76620	Seal Kit	x 1
PU8275	Flex Coupler 20MM x 1¾"	-
PU76215.5CP	Bell Housing	-

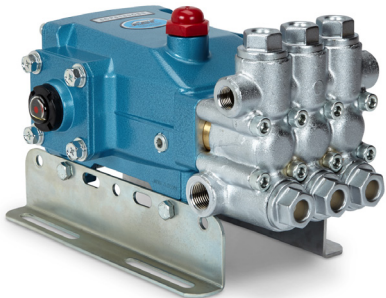

**5CP6180CSS DIRECT DRIVE**  
CAT PUMPS CERAMIC PLUNGER PUMPS



- FLOW: 8.2 GPM
- PRESSURE: 100 - 1500 PSI
- RPM: 1750 RPM
- HP: 8.4

**\$922.12** PU5CP6180CSS

**5CP6180CSS KITS**  
CAT PUMPS CERAMIC PLUNGER PUMP KITS

PART #	DESCRIPTION	KITS NEEDED
PU34920	Valve Kit	x 2
PU76620	Seal Kit	x 1
PU8275	Flex Coupler 20MM x 1¾"	-
PU76215.5CP	Bell Housing	-

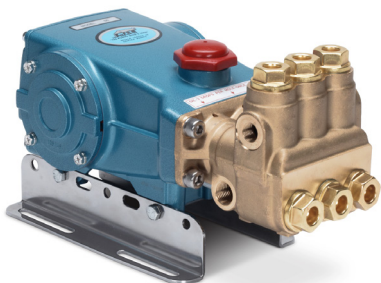

**56**  
CAT PUMPS CERAMIC PLUNGER PUMPS



- FLOW: 5.5 GPM
- PRESSURE: 100 - 3500 PSI
- RPM: 1210 RPM
- HP: 13.2

**\$1,467.91** PU00056

**56 KITS**  
CAT PUMPS CERAMIC PLUNGER PUMP KITS

PART #	DESCRIPTION	KITS NEEDED
PU33820	Valve Kit	x 2
PU30799	Seal Kit	x 1
PU30645	Pump Rails	-
PU30206	Pump Pulley	-

## CAT PUMPS® CERAMIC PLUNGER PUMPS

THESE PUMPS ARE ROHS COMPLIANT

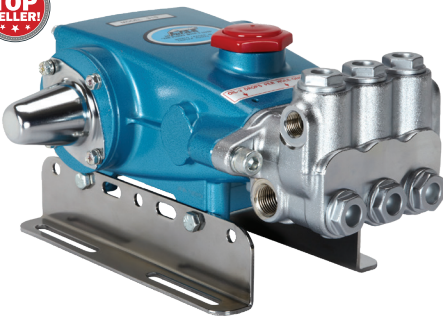

### 310 CAT PUMPS CERAMIC PLUNGER PUMPS



- FLOW: 4 GPM
- RPM: 950 RPM
- PRESSURE: 100 - 2200 PSI
- HP: 6

**\$711.38** PU00310

### 310S CAT PUMPS CERAMIC PLUNGER PUMPS



- FLOW: 4 GPM
- RPM: 950 RPM
- PRESSURE: 100 - 2200 PSI
- HP: 6

**\$780.94** PU00310S

### 310B CAT PUMPS CERAMIC PLUNGER PUMPS



- FLOW: 4 GPM
- RPM: 950 RPM
- PRESSURE: 100 - 2200 PSI
- HP: 6

**\$774.48** PU00310B

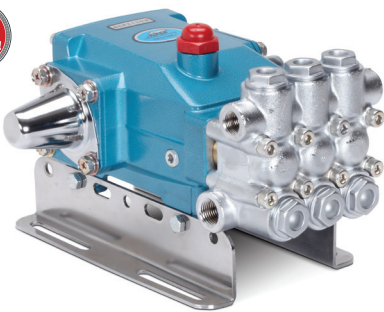

### 5CP2120W & 5CP2120B CAT PUMPS CERAMIC PLUNGER PUMPS



- FLOW: 4 GPM
- RPM: 950 RPM
- PRESSURE: 100 - 2500 PSI
- HP: 6.9

**\$683.66** PU5CP2120W  
**\$795.64** PU5CP2120B

### 3CP1120 CAT PUMPS CERAMIC PLUNGER PUMPS



- FLOW: 4.2 GPM
- RPM: 1725 RPM
- PRESSURE: 100 - 2200 PSI
- HP: 6.3

**\$550.40** PU3CP1120

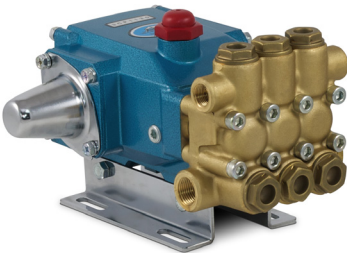

### 270 CAT PUMPS CERAMIC PLUNGER PUMPS



- FLOW: 3.5 GPM
- RPM: 1420 RPM
- PRESSURE: 100 - 1500 PSI
- HP: 3.6

**\$588.80** PU00270

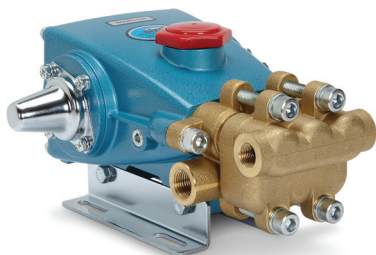

### 1540E CAT PUMPS CERAMIC PLUNGER PUMPS



- FLOW: 19.3 GPM
- RPM: 1180 RPM
- PRESSURE: 100 - 1200 PSI
- HP: 15.8

**\$2,501.12** PU1540E



### 310 & 310S KITS CAT PUMPS CERAMIC PLUNGER PUMP KITS

PART #	DESCRIPTION	KITS NEEDED
PU30821	Valve Kit	x 2
PU30623	Seal Kit	x 1
PU30945	Bushing	-
PU30633	Pump Pulley	-
PU30696	Reverse Plier	-
PU33004	Seal Case Socket for 1/2" Drive	-
PU810027	Complete Head for 310, 340, 350	-
PU310RA-WP	Rear Assembly with Plungers	-

### 5CP2120W & 5CP2120B KITS CAT PUMPS CERAMIC PLUNGER PUMP KITS

PART #	DESCRIPTION	KITS NEEDED
PU30821	Valve Kit	x 2
PU33628	Seal Kit	x 1
PU30945	Bushing	-
PU30611	Pump Rails	-
PU30633	Pump Pulley	-

### 3CP1120 CAT PUMPS CERAMIC PLUNGER PUMP KITS

PART #	DESCRIPTION	KITS NEEDED
PU33062	Valve Kit	x 2
PU33983	Seal Kit	x 1
PU30612	Pump Rails	-
PU30246	Pump Pulley	-

### 270 KITS CAT PUMPS CERAMIC PLUNGER PUMP KITS

PART #	DESCRIPTION	KITS NEEDED
PU30915	Valve Kit	x 1
PU30914	Seal Kit	x 1
PU30612	Pump Rails	-
PU30246	Pump Pulley	-

### 1540E KITS CAT PUMPS CERAMIC PLUNGER PUMP KITS

PART #	DESCRIPTION	KITS NEEDED
PU31775	Valve Kit	x 2
PU31770	Seal Kit	x 1
PU30613	Pump Rails	-
PU30206	Pump Pulley 10" 2-Groove	-



# PUMPS

## CAT PUMPS® CERAMIC PLUNGER PUMPS

THESE PUMPS ARE ROHS COMPLIANT

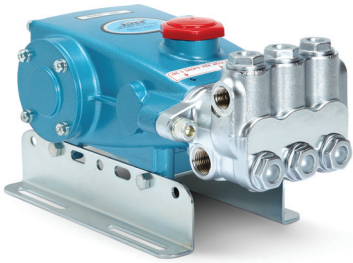

### 340 DIRECT DRIVE

CAT PUMPS CERAMIC PLUNGER PUMPS



- FLOW: 4 GPM
- RPM: 1725 RPM
- PRESSURE: 100 - 1800 PSI
- HP: 5.0

<b>\$711.38</b>	<b>PU00340</b>	With Brass Manifold
<b>\$780.94</b>	<b>PU00340S</b>	With Stainless Steel Sleeves
<b>\$774.48</b>	<b>PU00340B</b>	With Special Brass Manifold

### 350 DIRECT DRIVE

CAT PUMPS CERAMIC PLUNGER PUMPS



- FLOW: 5 GPM
- RPM: 1725 RPM
- PRESSURE: 100 - 1500 PSI
- HP: 5.1

<b>\$711.38</b>	<b>PU00350</b>	With Brass Manifold
<b>\$820.74</b>	<b>PU00350B</b>	With Special Brass Manifold

### 350S

CAT PUMPS CERAMIC PLUNGER PUMPS



- FLOW: 5 GPM
- RPM: 1725 RPM
- PRESSURE: 100-1500 PSI

<b>\$827.98</b>	<b>PU00350S</b>	304 stainless steel sleeve inserts
-----------------	-----------------	------------------------------------

### 530

CAT PUMPS CERAMIC PLUNGER PUMPS



- FLOW: 5 GPM
- RPM: 1100 RPM
- PRESSURE: 100 - 2500 PSI
- HP: 8.6

<b>\$1,203.71</b>	<b>PU00530</b>
-------------------	----------------

### 1050

CAT PUMPS CERAMIC PLUNGER PUMPS



- FLOW: 10 GPM
- RPM: 958 RPM
- PRESSURE: 100 - 2200 PSI
- HP: 15.1

<b>\$2,142.21</b>	<b>PU01050</b>
-------------------	----------------

### 3535

CAT PUMPS CERAMIC PLUNGER PUMPS



- FLOW: 36 GPM
- RPM: 800 RPM
- PRESSURE: 100 - 1200 PSI
- HP: 29.7

<b>\$4,660.68</b>	<b>PU03535</b>
-------------------	----------------

### 340 KITS

CAT PUMPS CERAMIC PLUNGER PUMP KITS

PART #	DESCRIPTION	KITS NEEDED
<b>PU30821</b>	Valve Kit	x 2
<b>PU30623</b>	Seal Kit	x 1
<b>PU08022</b>	Hollow Shaft Motor Flange	-
<b>PU76184.5FR</b>	Bell Housing	-
<b>PU08230</b>	Flex Coupler 20mm x 1½"	-

\* FOR USE WITH BALDOR MOTOR PU8029M

### 350 & 350S KITS

CAT PUMPS CERAMIC PLUNGER PUMP KITS

PART #	DESCRIPTION	KITS NEEDED
<b>PU30821</b>	Valve Kit	x 2
<b>PU30623</b>	Seal Kit	x 1
<b>PU76184.5FR</b>	Bell Housing	-
<b>PU08230</b>	Flex Coupler 20MM x 1½"	-

### 530 KITS

CAT PUMPS CERAMIC PLUNGER PUMPS

PART #	DESCRIPTION	KITS NEEDED
<b>PU30820</b>	Valve Kit	x 2
<b>PU30488</b>	Seal Kit	x 1
<b>PU30645</b>	Pump Rails	-
<b>PU30206</b>	Pump Pulley	-

### 1050 KITS

CAT PUMPS CERAMIC PLUNGER PUMP KITS

PART #	DESCRIPTION	KITS NEEDED
<b>PU34920</b>	Valve Kit	x 2
<b>PU30913</b>	Seal Kit	x 1
<b>PU30613</b>	Pump Rails	-
<b>PU30206</b>	Pump Pulley	-

### 3535 KITS

CAT PUMPS CERAMIC PLUNGER PUMP KITS

PART #	DESCRIPTION	KITS NEEDED
<b>PU34235</b>	Valve Kit	x 2
<b>PU31040</b>	Seal Kit	x 1
<b>PU92674</b>	Pump Rails	-
<b>Factory Sized</b>	Pump Pulley	-

FOR HIGHER GPM NEEDS, CONSIDER 3545

## CAT PUMPS® PISTON PUMPS

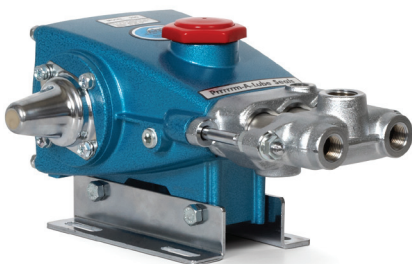

### 290

CAT PUMPS PISTON PUMPS



- FLOW: 3.5 GPM
- RPM: 1200 RPM
- PRESSURE: 100 - 1200 PSI
- HP: 2.9

<b>\$572.93</b>	<b>PU00290</b>
-----------------	----------------

### 290 KITS

CAT PUMPS PISTON PUMP KITS

PART #	DESCRIPTION	KITS NEEDED
<b>PU76023</b>	Cup Kit	x 1
<b>PU30686</b>	Valve Kit (Quiet)	x 1
<b>PU30305</b>	Seal Kit	x 1
<b>PU30431</b>	Sleeve & Seal Kit	x 1
<b>PU30272</b>	Hot-Cup Kit	x 1
<b>PU30246</b>	Pulley & Key	-

## CAT PUMPS® PISTON PUMPS

THESE PUMPS ARE ROHS COMPLIANT



**323**  
CAT PUMPS PISTON PUMPS



- FLOW: 5.0 GPM
- RPM: 1000 RPM
- PRESSURE: 100 - 1500 PSI
- HP: 5.1

**\$871.93** PU00323

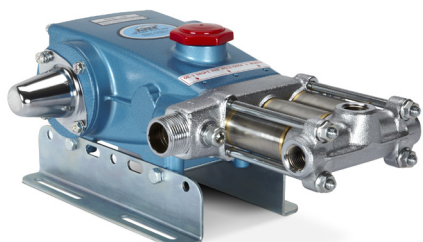

**390**  
CAT PUMPS PISTON PUMPS



- FLOW: 12 GPM
- RPM: 1200 RPM
- PRESSURE: 100 - 600 PSI
- HP: 4.9

**\$949.76** PU00390



**430**  
CAT PUMPS PISTON PUMPS



- FLOW: 5.0 GPM
- RPM: 1040 RPM
- PRESSURE: 100 - 1000 PSI
- HP: 3.4

**\$808.96** PU00430

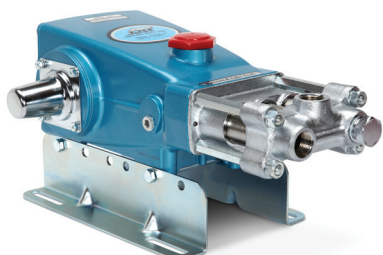

**623**  
CAT PUMPS PISTON PUMPS



- FLOW: 6.0 GPM
- RPM: 850 RPM
- PRESSURE: 100 - 1,200 PSI
- HP: 4.9

**\$1,380.86** PU00623

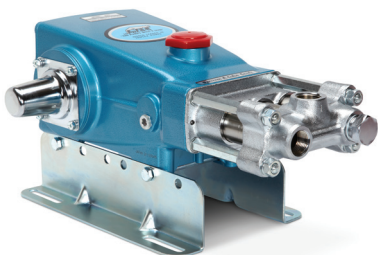

**820**  
CAT PUMPS PISTON PUMPS



- FLOW: 10 GPM
- RPM: 940 RPM
- PRESSURE: 100 - 1000 PSI
- HP: 6.9

**\$1,380.86** PU00820

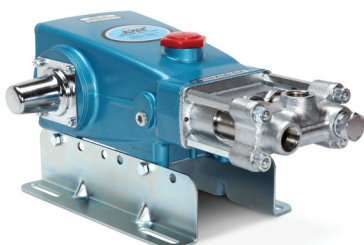

**1010**  
CAT PUMPS PISTON PUMPS



- FLOW: 13 GPM
- RPM: 900 RPM
- PRESSURE: 100 - 700 PSI
- HP: 6.2

**\$1,380.86** PU1010

### 323 KITS

CAT PUMPS PISTON PUMP KITS

PART #	DESCRIPTION	KITS NEEDED
PU30993	Cup Kit	x 1
PU30859	Valve Kit	x 1
PU30305	Seal Kit	x 1
PU30312	Sleeve & Seal Kit	x 1
PU30858	Bac-Cup Kit	x 1
PU34011	Blue Dot Seal Kit	x 1
PU30611	Pump Rails	-
PU30633	Pump Pulley	-

### 390 KITS

CAT PUMPS PISTON PUMPS

PART #	DESCRIPTION	KITS NEEDED
PU31822	Cup Kit	x 1
PU34010	Valve Kit	x 1
PU31824	Sleeve & Seal Kit	x 1
PU30611	Pump Rails	-
PU30633	Pump Pulley	-

### 430 KITS

CAT PUMPS PISTON PUMP KITS

PART #	DESCRIPTION	KITS NEEDED
PU30023	Cup Kit	x 1
PU30686	Valve Kit	x 1
PU30305	Seal Kit	x 1
PU30312	Sleeve & Seal Kit	x 1
PU30229	Blue Dot Seal Kit	x 1
PU30611	Pump Rails	-
PU30048	Pump Pulley	-

### 623 KITS

CAT PUMPS PISTON PUMP KITS

PART #	DESCRIPTION	KITS NEEDED
PU30220	Cup Kit	x 1
PU30687	Valve Kit	x 1
PU30305	Seal Kit	x 1
PU30397	Sleeve & Seal Kit	x 1
PU30822	Bac-Cup Kit	x 1
PU30226	Blue Dot Seal Kit	x 1
PU30613	Pump Rails	-

### 820

CAT PUMPS PISTON PUMP KITS

PART #	DESCRIPTION	KITS NEEDED
PU30222	Cup Kit	x 1
PU30687	Valve Kit	x 1
PU30305	Seal Kit	x 1
PU30397	Sleeve & Seal Kit	x 1
PU30226	Blue Dot Seal Kit	x 1
PU30613	Pump Rails	-

### 1010

CAT PUMPS PISTON PUMP KITS

PART #	DESCRIPTION	KITS NEEDED
PU30224	Cup Kit	x 1
PU30687	Valve Kit	x 1
PU30305	Seal Kit	x 1
PU30397	Sleeve & Seal Kit	x 1
PU30226	Blue Dot Seal Kit	x 1
PU30613	Pump Rails	-

# PUMPS

## CAT PUMPS® CENTRIFUGAL PUMPS

New!



### VARIOUS CENTRIFUGAL PUMPS

CAT PUMPS CENTRIFUGAL PUMPS



- Stainless steel end-suction single stage centrifugal pumps offer dependable performance and flexibility in moving high volume liquids at low pressure. Sold as either a Pump Kit With Seal or Motorized Unit. \*Two Stage Motorized Unit available upon request.

<b>\$851.46</b>	<b>PU3K124WT313</b>	Cat Pump 1HP 3PH 24GPM 45PSI
<b>\$825.34</b>	<b>PU3K152WT0</b>	Cat Pump 1 1/2HP 1PH 63GPM 44PSI
<b>\$904.70</b>	<b>PU3K162WT3</b>	Cat Pump 3HP 3PH 63GPM 63PSI
<b>\$981.08</b>	<b>PU3K131MT3</b>	Cat Pumps 2HP 3PH 38GPM 63PSI

## PUMP SUPPLIES & KITS

### CAT PUMPS 310 REPAIR KIT

KLEEN-RITE KITS



- Kit will service 310, 310B, 310S, 340 and 350 pumps.
- (1) 36H993 Nitrile Coated Gloves - Large
- (1) 6100 Cat Pumps Oil - 21 oz. Bottle
- (1) **30623 CAT PUMPS SEAL KIT**
  - (3) 43307 Seal, HPS w/S-NBR
  - (3) 43305 Seal, LPS w/S-Spg-NBR
  - (3) 14200 O-Ring, Seal Case-NBR
  - (3) 17399 O-Ring, Ret, Plgr-NBR
  - (3) 43302 Wick, Long Tab
- (2) **30821 CAT PUMPS VALVE KITS**
  - (3) 44565 Retainer, Spring-PVDF
  - (3) 43750 Spring-S
  - (3) 43723 Valve-S
  - (3) 43725 Seat-S
  - (3) 43358 O-Ring, Seat-70D-NBR
  - (3) 48361 Back-Up Ring, Seat-D
  - (3) 17615 O-Ring, Valve Plug-75D-NBR

**\$255.80** KRK2101

### CAT PUMPS 5CP2120W REPAIR KIT

KLEEN-RITE KITS



- Kit will service 5CP2120W pumps
- Seals, valves, and oil are genuine Cat Pumps® replacement parts
- (2) 30821 Valve Kits
  - (1) 33628 Seal Kit
- (1) 6100 Cat Pumps Oil - 21 oz. Bottle
  - (1) 36H993 Nitrile Coated Gloves - Large

**\$261.35** KRK2102

### OIL DRAIN KITS

CAT PUMPS SUPPLIES & KITS



- For 3FR, 4FR, 5FR, 7FR, 10FR, 15FR, 25FR Piston Pumps or Plunger Pumps

**\$46.08** PU34334

### OIL DRAIN KITS

CAT PUMPS SUPPLIES & KITS



- Fits piston pumps 6020-6041, plunger pumps 3501-3560, 3801-3841K, 6747-6775 & 6801-6861K

**\$51.98** PU34314

### CAT PUMPS OIL

CAT PUMPS SUPPLIES & KITS



<b>\$9.01</b>	<b>PU06100</b>	21 oz. bottles
<b>\$93.75</b>	<b>PU06105</b>	2.5 gallons



### ACCUMULATOR PULSATION DAMPENERS SUPPLIES & KITS

- Absorbs system shocks while minimizing pulsations, pipe vibration, water hammering and pressure fluctuations. Pumps will see decreased wear and have longer life. Pulsation dampeners are tied directly onto the discharge manifold or plumbed immediately downstream of the pump.

<b>\$80.18</b>	<b>PDK103</b>	10 GPM • 600-3000 PSI
<b>\$339.22</b>	<b>PDK403</b>	40 GPM • 3000 PSI





310-340-350-310B-340B-350B

CAT PUMPS

## PARTS LIST

ITEM	PART NUMBERS				DESCRIPTION	QTY
	310, 340 350		310B, 340B 350B			
	MATL		MATL			
2	30057	STL	30057	STL	Key (M6x6x25)	1
5	125824	STCP R	125824	STCP R	Screw, HHC, Sems (M6x16)	8
8	43344	AL	43344	AL	Cover, Bearing	2/1/2
10	43343	NBR	43343	NBR	O-Ring, Bearing Cover - 70D	2
11	43222	NBR	43222	NBR	Seal, Oil, Crankshaft	2/1/2
15	14480	STL	14480	STL	Bearing, Ball	2
20	45883	HS	45883	HS	Rod, Connecting Assy [09/05]	3
25	<b>43342</b>	FCM	<b>43342</b>	FCM	Crankshaft, Dual End - M18, 310, 310B	1
	<b>44945</b>	FCM	<b>44945</b>	FCM	Crankshaft, Single End -M10, 340, 340B	1
	<b>43838</b>	FCM	<b>43838</b>	FCM	Crankshaft, Dual End - M12, 350, 350B	1
30	44949	AL	44949	AL	Cover, Blind Shaft - 340, 340B	1
31	828710	—	828710	—	Protector, Oil Cap w/Foam Gasket	1
32	43211	ABS	43211	ABS	Cap, Oil Filler	1
33	14177	NBR	14177	NBR	O-Ring, Filler Cap - 70D	1
37	92241	—	92241	—	Gauge, Oil, Bubble w/Gasket	1
38	44428	NBR	44428	NBR	Gasket, Flat, Oil Gauge - 80D	1
40	126541	STCP R	126541	STCP R	Screw, HHC, Sems (M6x20)	4
48	25625	STCP	25625	STCP	Plug, Drain (1/4"x19 BSP)	1
49	23170	NBR	23170	NBR	O-Ring, Drain Plug - 70D	1
50	48772	AL	48772	AL	Cover, Rear [10/01] (See Tech Bulletin 090)	1
51	48773	NBR	48773	NBR	O-Ring, Rear Cover [10/01] (See Tech Bulletin 090)	1
53	48769	AL	48769	AL	Crankcase [05/02] (See Tech Bulletin 090)	1
56	43355	POP	43355	POP	Pan, Oil	1
64	43351	CM	43351	CM	Pin, Crosshead	3
65	43365	ZZCP	43365	ZZCP	Rod, Plunger	3
70	43228	NBR	43228	NBR	Seal, Oil, Crankcase	3
75	43328	S	43328	S	Slinger, Barrier	3
88	45697	S	45697	S	Washer, Keyhole (M18 x 10)	3
90	43367	CC	43367	CC	Plunger (M20x72)	3
96	43235	PTFE	43235	PTFE	Back-up-Ring, Plunger Retainer	3
97	17399	NBR	17399	NBR	O-Ring, Plunger Retainer - 80D	3
	14160	FPM	14160	FPM	O-Ring, Plunger Retainer - 80D	3
	◆ 46204	EPDM	◆ 46204	EPDM	O-Ring, Plunger Retainer - 70D	3
98	45891	CU	45891	CU	Gasket	3
99	104360	S	104360	S	Retainer, Plunger w/Stud	3
100	45688	PVDF	45688	PVDF	Retainer, Seal, 2-Pc [04/06] (See Tech Bulletin 105)	3
101	43302	—	43302	—	Wick, Long Tab	3
106	43305	NBR	43305	NBR	Seal, LPS w/S-Spg	3
	45153	FPM	45153	FPM	Seal, LPS w/SS-Spg	3
	◆ 48429	EPDM	◆ 48429	EPDM	Seal, LPS w/SS-Spg	3
	76305	ST2	76305	ST2	Seal, LPS w/S-Spg	3
120	45679	BB	45679	BB	Case, Seal	3
121	14200	NBR	14200	NBR	O-Ring, Seal Case - 70D	3
	11719	FPM	11719	FPM	O-Ring, Seal Case	3
	◆ 48907	EPDM	◆ 48907	EPDM	O-Ring, Seal Case	3
125	43307	SNG	43307	SNG	Seal, HPS w/S	3
	44936	FPM	44936	FPM	Seal, HPS w/SS	3
	46667	HT	46667	HT	Seal, HPS "Hi-Temp", 2-Pc w/S-Support	3
139	22179	BBCP	22179	BBCP	Plug, Inlet [1/2" NPT(M)]	1
162	48361	D	48361	D	Back-up-Ring, Seat	6
163	43358	NBR	43358	NBR	O-Ring, Seat - 70D	6
	44938	FPM	44938	FPM	O-Ring, Seat - 70D	6
	◆ 48908	EPDM	◆ 48908	EPDM	O-Ring, Seat	6
164	43725	S	43725	S	Seat	6
166	43723	S	43723	S	Valve	6
167	43750	S	43750	S	Spring, Valve	6
168	44565	PVDF	44565	PVDF	Retainer, Valve Spring	6
172	17615	NBR	17615	NBR	O-Ring, Valve Plug - 75D	6
	15855	FPM	15855	FPM	O-Ring, Valve Plug -70D	6
	◆ 48431	EPDM	◆ 48431	EPDM	O-Ring, Valve Plug -75D	6
174	43849	BBCP	43849	BBCP	Plug, Valve	6
185	<b>44837</b>	BBCP	<b>49721</b>	SBCP	Head, Manifold	1
188	126520	STCP R	126520	STCP R	Screw, HSH, Sems (M10x35)	2
250	118672	STCP	118672	STCP	Protector, Shaft (Belt Drive Only)	1
255	30243	STZP	30243	STZP	Mount, Direct (Belt Drive Only)	1
260	30611	STZP	30611	STZP	Mounting, Angle Rail (Belt Drive Only)	1
265	30659	—	30659	—	Mount, Assy (Incls: 30611, 30633, 118672) (Belt Drive Only)	1
270	30633	STL	30633	STL	Assy, Pulley & Key (Incls: 30058, 30057) (Belt Drive Only)	1
275	30944	STL	30944	STL	Assy, Hub & Key (Incls: 30057, 30945) (Belt Drive Only)	1

# PUMPS

310-340-350-310B-340B-350B  
CAT PUMPS



## EXPLODED VIEW

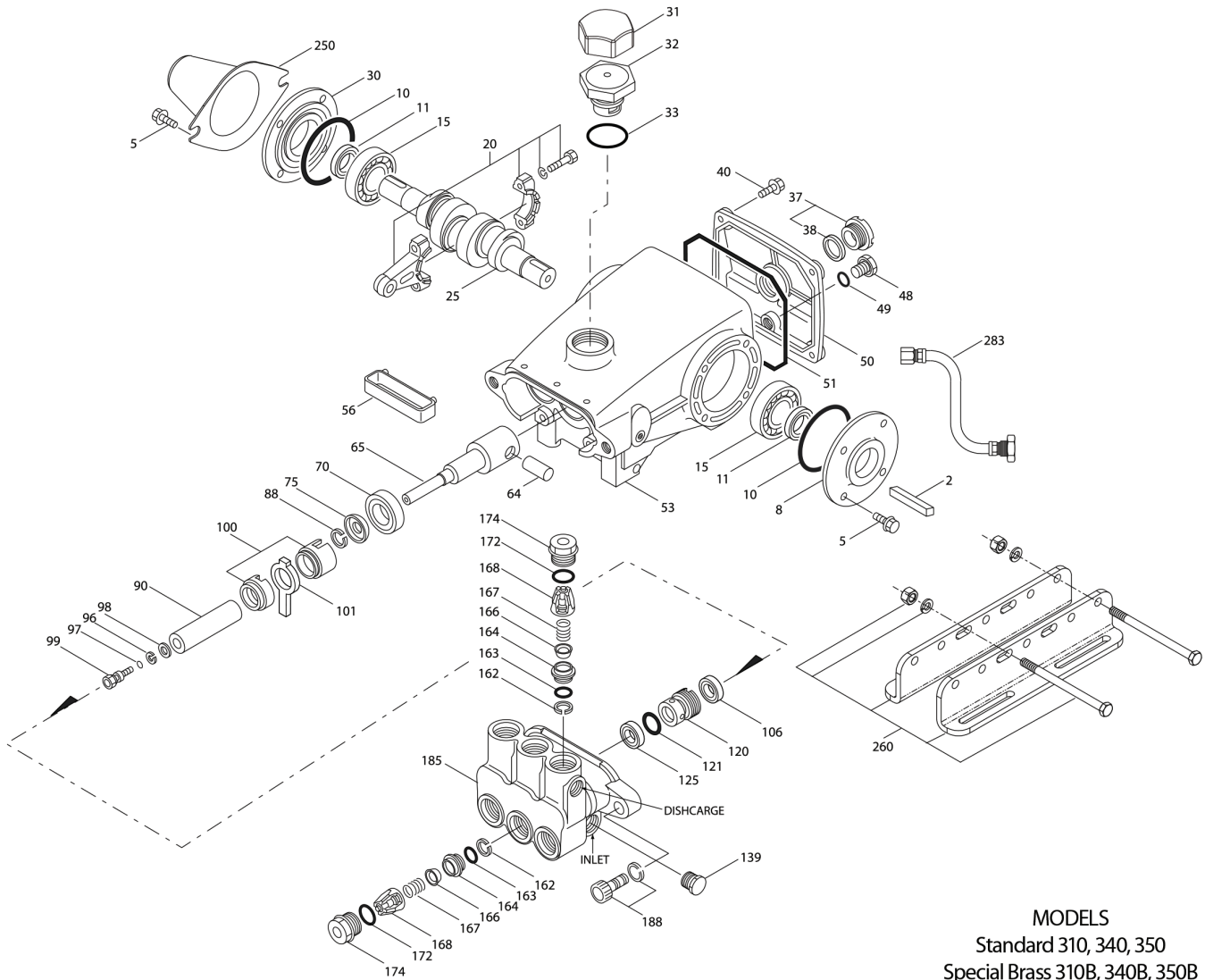

MODELS  
Standard 310, 340, 350  
Special Brass 310B, 340B, 350B  
May 2015

ITEM	PART NUMBERS		DESCRIPTION	QTY
	<b>310, 340</b>	<b>310B, 340B</b>		
	<b>350</b>	<b>350B</b>		
	<b>MATL</b>	<b>MATL</b>		
283	34334	34334	Kit, Oil Drain (3/8" x 24") (See Individual Data Sheet)	1
	76334	76334	Kit, Oil Indicator, (3/8" x 24) (See Individual Data Sheet)	1
299	<b>810027</b>	<b>818471</b>	Head, Complete <b>Standard</b>	1
300	30623	30623	Kit, Seal (Incls: 97, 101, 106, 121, 125) <b>Standard</b>	1
	34155	34155	Kit, Seal (Incls: 97, 101, 106, 121, 125) <b>.0110</b>	1
	33623	33623	Kit, Seal, "Hi-Temp" (Incls: 97, 101, 106, 121, 125) <b>.3000</b>	1
	◆ 31163	◆ 31163	Kit, Seal (Incls: 97, 101, 106, 121, 125) <b>.0220</b>	1
310	30821	30821	Kit, Valve, Preassembled (Incls: 162-164, 166-168, 172) <b>Standard, .3000</b>	2
	31821	31821	Kit, Valve, Preassembled (Incls: 162-164, 166-168, 172) <b>.0110</b>	2
	◆ 31162	◆ 31162	Kit, Valve, Preassembled (Incls: 162-164, 166-168, 172) <b>.0220</b>	2
350	30696	30696	Plier, Reverse	1
351	33004	33004	Socket, Seal Case (1/2" Drive)	1
—	6107	6107	Oil, Bottle (21 oz.) ISO-68 Hydraulic (Fill to specified crankcase capacity prior to start-up)	1



## 5CP2120W-5CP2140WCS-5CP2150W-5CP2120B-5CP2140BCS-5CP2150B

CAT PUMPS

### PARTS LIST

ITEM	PART NUMBER	MATL	PART NUMBER	MATL	PART NUMBER	MATL	DESCRIPTION	QTY
	5CP2120W 5CP2120B		5CP2140WCS 5CP2140BCS		5CP2150W 5CP2150B			
2	30057	STL	30057	STL	30057	STL	Key (M6x6x25)	1
5	126542	STCP R	126542	STCP R	126542	STCP R	Screw, Sems HHC (M8x16)	8
8	46910	AL	46910	AL	46910	AL	Cover, Bearing	2/1/2
10	14028	NBR	14028	NBR	14028	NBR	O-Ring, Bearing Cover - 70D	2
11	43222	NBR	43222	NBR	43222	NBR	Seal, Oil, Crankshaft - 70D	2/1/2
15	14480	STL	14480	STL	14480	STL	Bearing, Ball	2
20	48742	TNM	48742	TNM	48742	TNM	Rod, Connecting Assy [10/01]	3
25	46928	FCM	—	—	46982	FCM	Crankshaft, Dual End	1
	—	—	48203	FCM	—	—	Crankshaft, Single End	1
30	—	—	48224	AL	—	—	Cover, Bearing Blind	1
31	127409	—	127409	—	127409	—	Cap, Vented w/O-Ring (Rain Cap)	1
32	46798	—	46798	—	46798	—	Cap, Oil Filler, Domed	1
33	14179	NBR	14179	NBR	14179	NBR	O-Ring, Oil Filler Cap - 70D	1
37	92241	—	92241	—	92241	—	Gauge, Oil, Bubble w/Gasket - 80D	1
38	44428	NBR	44428	NBR	44428	NBR	Gasket, Flat, Oil Gauge - 80D	1
40	125824	STCP R	125824	STCP R	125824	STCP R	Screw, Sems HHC (M6x16)	4
48	25625	STCP	25625	STCP	25625	STCP	Plug, Drain (1/4"x19BSP)	1
49	23170	NBR	23170	NBR	23170	NBR	O-Ring, Drain Plug - 70D	1
50	46940	AL	46940	AL	46940	AL	Cover, Rear	1
51	14044	NBR	14044	NBR	14044	NBR	O-Ring, Rear Cover	1
53	48617	AL	48617	AL	48617	AL	Crankcase	1
64	46746	CM	46746	CM	46746	CM	Pin, Crosshead	3
65	48458	BBNP	48458	BBNP	48458	BBNP	Rod, Plunger	3
70	46838	NBR	46838	NBR	46838	NBR	Seal, Oil, Crankcase - 70D	3
75	43328	S	43328	S	43328	S	Slinger, Barrier	3
88	45697	S	45697	S	45697	S	Washer, Keyhole (M18 x 10)	3
90	46841	CC	46841	CC	46841	CC	Plunger (M20x50)	3
98	46730	NBR	46730	NBR	46730	NBR	Washer, Seal - 90D	3
	48394	FPM	48394	FPM	48394	FPM	Washer, Seal - 90D	3
	◆ 48432	EPDM	◆ 48432	EPDM	◆ 48432	EPDM	Washer, Seal	3
99	† 48201	SS	† 48201	SS	† 48201	SS	Retainer, Plunger w/Stud (M6)	3
100	46749	PVDF	46749	PVDF	46749	PVDF	Retainer, Seal	3
106	43305	NBR	43305	NBR	43305	NBR	Seal, LPS w/S-Spg	3
	45153	FPM	45153	FPM	45153	FPM	Seal, LPS w/SS-Spg	3
	◆ 48429	EPDM	◆ 48429	EPDM	◆ 48429	EPDM	Seal, LPS w/SS-Spg	3
	76305	ST2	76305	ST2	76305	ST2	Seal, LPS w/SS-Spg	3
120	46843	BB	46843	BB	46843	BB	Case, Seal (Press-in-style)	3
	49436	BB	49436	BB	49436	BB	Case, Seal (Use w/76305,13978)	3
121	13978	NBR	13978	NBR	13978	NBR	O-Ring, Seal Case - 70D	3
	14329	FPM	14329	FPM	14329	FPM	O-Ring, Seal Case	3
	◆ 48904	EPDM	◆ 48904	EPDM	◆ 48904	EPDM	O-Ring, Seal Case	3
125	43307	SNG	43307	SNG	43307	SNG	Seal, HPS w/S	3
	44936	FPM	44936	FPM	44936	FPM	Seal, HPS w/SS	3
	46667	HT	46667	HT	46667	HT	Seal, HPS 2-Pc w/S-Support	3
139	22179	BBCP	22179	BBCP	22179	BBCP	Plug, Inlet [1/2"NPT(M)]	1
162	48361	D	48361	D	48361	D	Back-up-Ring, Seat	6
163	43358	NBR	43358	NBR	43358	NBR	O-Ring, Seat - 70D	6
	44938	FPM	44938	FPM	44938	FPM	O-Ring, Seat - 70D	6
	◆ 48908	EPDM	◆ 48908	EPDM	◆ 48908	EPDM	O-Ring, Seat	6
164	43725	S	43725	S	43725	S	Seat	6
166	43723	S	43723	S	43723	S	Valve	6
167	43750	S	43750	S	43750	S	Spring	6
168	44565	PVDF	44565	PVDF	44565	PVDF	Retainer, Spring	6
172	17615	NBR	17615	NBR	17615	NBR	O-Ring, Valve Plug - 75D	6
	15855	FPM	15855	FPM	15855	FPM	O-Ring, Valve Plug - 70D	6
	◆ 48431	EPDM	◆ 48431	EPDM	◆ 48431	EPDM	O-Ring, Valve Plug - 75D	6
174	43849	BBCP	43849	BBCP	43849	BBCP	Plug, Valve	6
185	48245	W770	48245	W770	48245	W770	Manifold, Head - W770	1
	49716	SBCP	49716	SBCP	49716	SBCP	Manifold, Head - Special Brass	1
188	126513	STCP R	126513	STCP R	126513	STCP R	Screw, HSH (M8x70)	8
196	22187	BBCP	22187	BBCP	22187	BBCP	Plug, Discharge [3/8"NPT(M)]	1
250	118672	STCP	—	—	118672	STCP	Protector, Shaft	1
255	30243	STZP	30243	STZP	30243	STZP	Mount, Direct (Not Shown)	1
260	30611	STZP R	30611	STZP R	30611	STZP R	Mounting, Angle Rail (Belt Drive Only)	1
	30637	STZP	30637	STZP	30637	STZP	Mount, Angle Assy-Retro Fit (See Tech Bulletin 078)	1
265	30659	—	30659	—	30659	—	Mount, Assy (Incls: 30611, 30633, 118672)	1
275	30944	STL	30944	STL	30944	STL	Assy, Hub & Key (Incls: 30057, 30945)	1
283	34334	—	34334	—	34334	—	Kit, Oil Drain (3/8" x 24") (see Individual Data Sht)	1
	76334	—	76334	—	76334	—	Kit, Oil Level Indicator (3/8" x 24") (see Individual Data Sht)	1





### EXPLODED VIEW

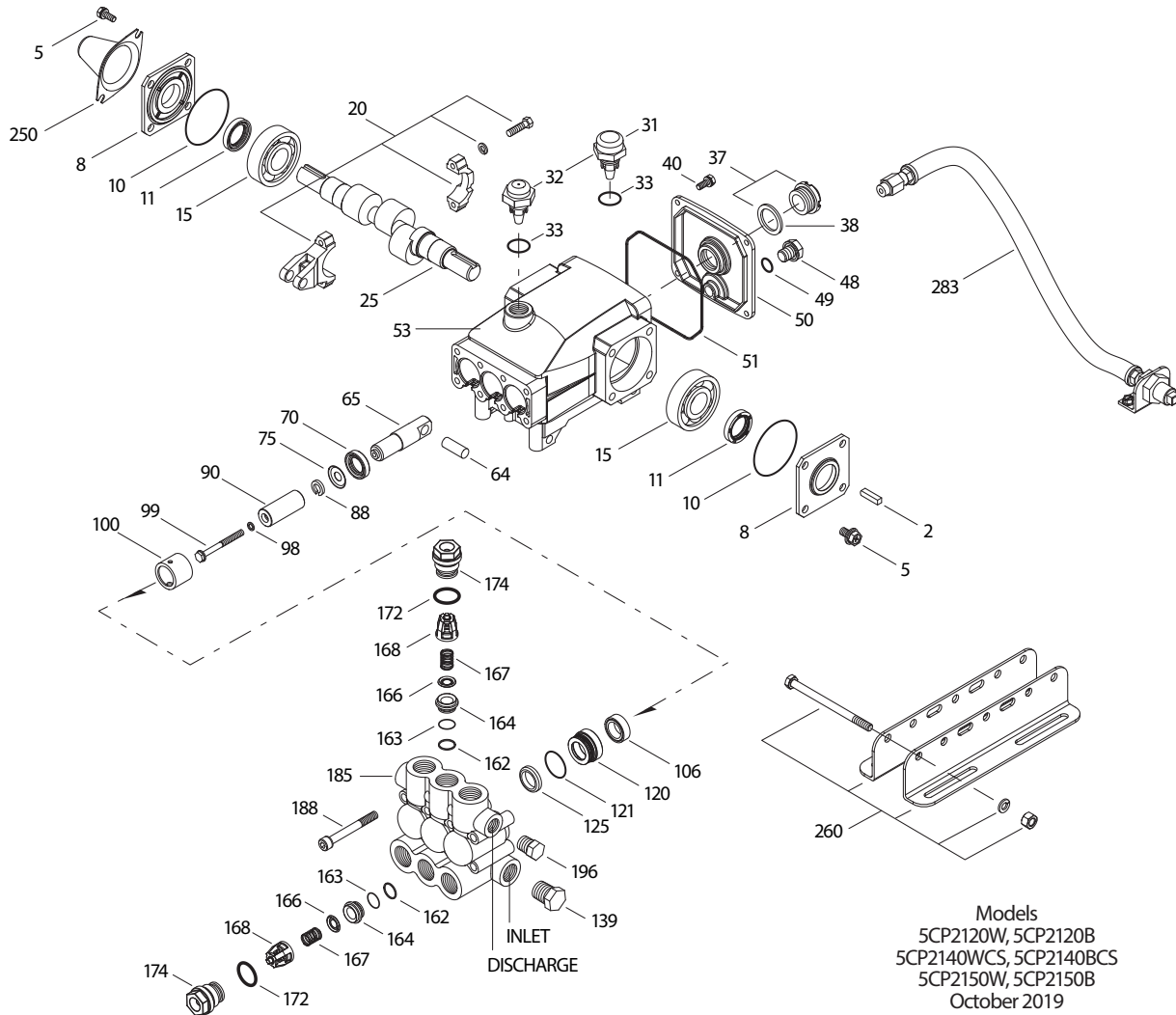

Models  
5CP2120W, 5CP2120B  
5CP2140WCS, 5CP2140BCS  
5CP2150W, 5CP2150B  
October 2019

ITEM	PART NUMBER	MATL	PART NUMBER	MATL	PART NUMBER	MATL	DESCRIPTION	QTY
	<b>5CP2120W</b>		<b>5CP2140WCS</b>		<b>5CP2150W</b>			
	<b>5CP2120B</b>		<b>5CP2140BCS</b>		<b>5CP2150B</b>			
299	816650	W770	816650	W770	816650	W770	Head, Complete - W770 w/NBR Seals & O-Rings	1
	818472	SBCP	818472	SBCP	818472	SBCP	Head, Complete - Special Brass w/NBR Seals & O-Rings	1
300	33628	NBR	33628	NBR	33628	NBR	Kit, Seal (Incls: 98, 106, 121, 125) <b>Standard</b>	1
	31628	FPM	31628	FPM	31628	FPM	Kit, Seal (Incls: 98, 106, 121, 125) <b>.0110</b>	1
◆	31648	EPDM*	◆ 31648	EPDM*	◆ 31648	EPDM*	Kit, Seal (Incls: 98, 106, 121, 125) <b>.0220</b>	1
	31638	HT	31638	HT	31638	HT	Kit, Seal (Incls: 98, 106, 121, 125) <b>.3000</b>	1
	76536	STHT	76536	STHT	76536	STHT	Kit, Seal (Incls: 98, 106, 120, 121, 125) <b>.3400</b>	1
310	30821	NBR	30821	NBR	30821	NBR	Kit, Valve, Preassembled (Incls: 162 - 164, 166 - 168, 172) <b>Standard, .3000, .3400</b>	2
	31821	FPM	31821	FPM	31821	FPM	Kit, Valve, Preassembled (Incls: 162 - 164, 166 - 168, 172) <b>.0110</b>	2
◆	31162	EPDM	◆ 31162	EPDM	◆ 31162	EPDM	Kit, Valve, Preassembled (Incls: 162 - 164, 166 - 168, 172) <b>.0220</b>	2
—	6107	—	6107	—	6107	—	Oil, Bottle (21 oz) ISO-68 Hydraulic (Fill to specified crankcase capacity prior to start-up)	1

**Bold print part numbers are unique to a particular pump model. Italics are optional items. ◆ Silicone oil/grease required. † Production parts are different than repair parts.**  
R Components comply with RoHS Directive. [ ] Date of latest production change. W770 effective with 97 production.

\*Review individual parts in each kit for material code identification.

Review Tech Bulletins 024, 036, 043, 053, 060, 061, 064, 073, 074, 078, 083 and 103 for additional information.

MATERIAL CODES (Not Part of Part Number): AL=Aluminum BB=Brass BBBCP=Brass/Chrome Plated BBNP=Brass/Nickel Plated CC=Ceramic CM=Chrome-moly D=Acetal

EPDM=Ethylene Propylene Diene Monomer FCM=Forged Chrome-moly FPM=Fluorocarbon HT=Hi-Temp (EPDM Alternative) NBR=Medium Nitrile (Buna-N)

PVDF=Polyvinylidene Fluoride S=304SS SBCP=Special Brass/Chrome Plated SS=316SS SNG=Special Blend (Buna) ST 2=Special PTFE 2 STL=Steel STHT=Special PTFE High Temp

STCP=Steel/Chrome Plated STZP=Steel/Zinc Plated TNM=Special High Strength W770=Special Alloy

## EMPEROR SERIES FROM GENERAL PUMP®

### EMPEROR SERIES GENERAL PUMP



- Specifically designed to handle the rigorous duty cycles, high temperatures and chemicals associated with self-serve carwash applications.
- These premium pumps can withstand temperatures up to 185 °F and can run dry for several hours.



### GPHTS2215SR

EMPEROR SERIES FROM GENERAL PUMP

- **FLOW:** 4.0/5.0 GPM
- **PSI:** 2300
- **SHAFT OD:** 24MM
- **RPM:** 950/1200

#### FEATURES & BENEFITS:

- Can run dry for several hours
- Water temps up to 185 °F
- Nickel-plated manifold & valve caps provide corrosion resistant operation and helps reduce damage caused by cavitation
- Side sight glass
- Direct replacement for CAT 310/5CP2120W with same RPM and Flow
- **SPECIFY LEFT HAND DRIVE IF YOU'RE LOOKING AT THE PUMP MANIFOLD AND YOUR PULLEY OR THE PUMP CRANKSHAFT IS ON THE LEFT**

<b>\$730.46</b>	<b>GPHTS2215SR</b>	Right Side Shaft
<b>\$730.46</b>	<b>GPHTS2215SL</b>	Left Side Shaft



### GPHTS2215SR PARTS & KITS

EMPEROR SERIES FROM GENERAL PUMP

- If replacing CAT 310/5CP2120W you may also want to order the following:

<b>\$19.01</b>	<b>GPP540015</b>	Adapter Rail Kit
<b>\$15.66</b>	<b>PU33000</b>	24mm "H" Bushing
<b>\$23.25</b>	<b>GPP540016</b>	Rail Kit for CAT 530
<b>\$6.67</b>	<b>GP0100216</b>	Series 100 Oil - 16oz bottle
<b>\$81.88</b>	<b>GP0100552</b>	Series 100 Oil - 2½ gal



These innovative and patented pumps offer increased pump life and performance, making them perfect for the car wash industry!

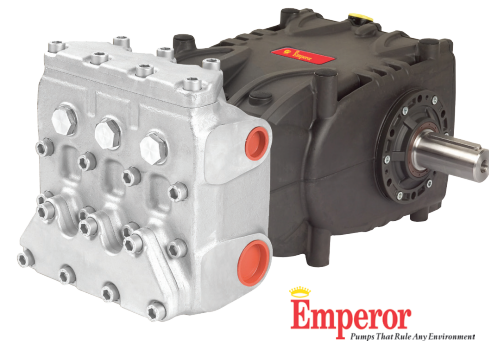

### GPHTCK4050S

EMPEROR SERIES FROM GENERAL PUMP

- 36 GPM @ 800 RPM, 1500 PSI
- 40.5 GPM @ 900 RPM, 1500 PSI
- Shaft OD: 40MM

<b>\$3,731.77</b>	<b>GPHTCK4050S</b>
-------------------	--------------------

### GPHTCK4050S OIL & KITS

EMPEROR SERIES FROM GENERAL PUMP

<b>\$341.56</b>	<b>GPK2012</b>	Valve Kit
<b>\$346.55</b>	<b>GPK2013</b>	Discharge Valve Kit
<b>\$593.94</b>	<b>GPK2033</b>	Hi-Temp Seal Kit
<b>\$260.09</b>	<b>GPK2034</b>	Packing Kit
<b>\$75.19</b>	<b>GP0100450</b>	2½ Gallon - 220 Oil



### GPHTCK4050S CONVERSION PARTS

EMPEROR SERIES FROM GENERAL PUMP

If converting from CW1451 Pump you will need 1 of each of the parts in the chart below

<b>\$25.50</b>	<b>GPPZUH40</b>	Hub for Pump
<b>\$28.60</b>	<b>GPPZUH178</b>	Hub for Motor
<b>\$263.81</b>	<b>GPPZP3B136</b>	Pulley for Pump
<b>\$94.86</b>	<b>GPPZP3B60</b>	Pulley for Motor
<b>\$51.87</b>	<b>GPP510476</b>	1½" Hose Barb

AND choose (1) from the below:

<b>\$151.63</b>	<b>GPPHT150CWS</b>	If your pump is positioned <b>above</b> the motor on a PDQ Pump Stand
<b>\$151.63</b>	<b>GPPHT150CWL</b>	If your pump is positioned <b>below</b> the motor on a PDQ Pump Stand
<b>\$109.22</b>	<b>GPPHT150RCK</b>	If you are converting from a Cat 3535 to a HTCR4050S



### PEHT PLATINUM SERIES PUMPS

EMPEROR SERIES FROM GENERAL PUMP

- Forged stainless steel manifold with a nickel plated crankcase, solid ceramic plungers, heavy-duty tapered roller bearings, and HT technology packings.
- **PRESSURE:** 3000 PSI
- **MAX. TEMP.:** 185°F

PRICE	PART #	SHAFT	GPM	RPM	HP
<b>\$708.28</b>	<b>GPEHT2214SR</b>	Right	4	950	5.2
<b>\$708.28</b>	<b>GPEHT2214SL</b>	Left			
<b>\$708.29</b>	<b>GPEHT2010SR</b>	Right	3.43-4	1450-1750	7-8.2
<b>\$708.28</b>	<b>GPEHT2010SL</b>	Left			
<b>\$708.28</b>	<b>GPEHT2012SR</b>	Right	2.64-4.76	950-1750	5.4-9.8
<b>\$708.28</b>	<b>GPEHT2012SL</b>	Left			
<b>\$708.28</b>	<b>GPEHT2213SR</b>	Right	3.43-5.55	950-1450	7-11.4
<b>\$708.28</b>	<b>GPEHT2213SL</b>	Left			



### PEHT2214S PARTS & KITS

EMPEROR SERIES FROM GENERAL PUMP

<b>\$25.14</b>	<b>GPPZBBH24</b>	Pulley Bushing (Recommended)
<b>\$130.42</b>	<b>GPP101112</b>	SS Rail Kit for CAT 310/5CP Conversion

The PEHT2214S is a direct replacement for Cat 310/5CP2120W with the same RPM and flow

The PEHT2010S is a direct replacement for Cat 5CP2140 with the same RPM and flow

# PUMPS

## EMPEROR SERIES FROM GENERAL PUMP®

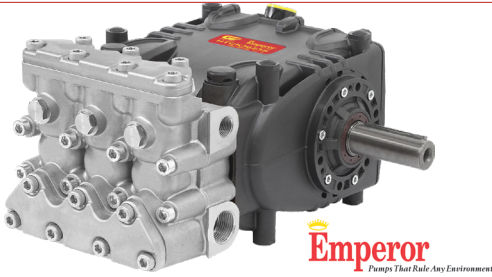

### GPHTCK3623S EMPEROR SERIES FROM GENERAL PUMP



- FLOW: 18/21/25 GPM
- RPM: 1000/1150/1350
- PSI: 1500/1300
- SHAFT OD: 30MM

**\$2,954.60** GPHTCK3623S

### GPHTCK3623S KITS & OIL EMPEROR SERIES FROM GENERAL PUMP

<b>\$640.82</b>	<b>GPK2030</b>	Valve Kit
<b>\$452.50</b>	<b>GPK212</b>	High Pressure Seal Kit
<b>\$233.40</b>	<b>GPK2032</b>	High Temperature Packing Kit
<b>\$75.19</b>	<b>GPO100450</b>	2½ Gallon 220 Series Oil

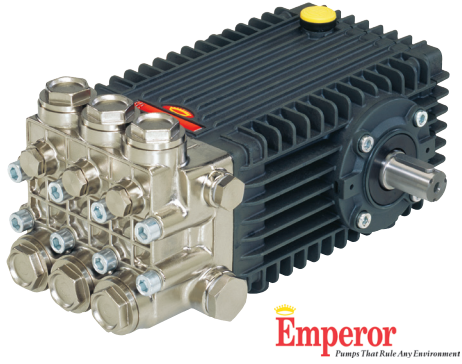

### HTF SERIES EMPEROR SERIES FROM GENERAL PUMP



- SHAFT OD: 24MM

<b>\$1,565.95</b>	<b>GPHTF2018S</b>	GPM: 4.0/5.0/7.5
	<b>GPHTF2018SL*</b>	PSI: 3600
<b>\$1,565.95</b>	<b>GPHTF2221S</b>	RPM: 950/1200/1750
	<b>GPHTF2221SL*</b>	GPM: 8.5/10.2
<b>\$1,565.95</b>	<b>GPHTF2421S</b>	PSI: 3000
	<b>GPHTF2421SL*</b>	RPM: 1450/1750
<b>\$1,565.95</b>	<b>GPHTF2421S</b>	GPM: 10.0/12.0
	<b>GPHTF2421SL*</b>	PSI: 3000/2500
<b>\$1,565.95</b>	<b>GPHTF2421S</b>	RPM: 1450/1750
	<b>GPHTF2421SL*</b>	

**\*Left Side Shafts**

### HTF SERIES PUMP OILS EMPEROR SERIES FROM GENERAL PUMP

<b>\$6.67</b>	<b>GPO100216</b>	Series 100 Oil - 16oz bottle
<b>\$81.88</b>	<b>GPO100552</b>	Series 100 Oil - 2½ gal.

## GENERAL PUMP®

**New!**



### PHTCK4050S PLUNGER PUMP GENERAL PUMP



- SHAFT OD: 40MM
- MAX. TEMP.: 140 °F

<b>\$3,704.32</b>	<b>GPPHTCK4050S</b>	GPM: 45
	<b>GPPHTCK4050SL*</b>	PSI: 1500
<b>\$3,704.32</b>	<b>GPPHTCK4050S</b>	RPM: 900
	<b>GPPHTCK4050SL*</b>	

**\*Left Side Shafts**

### PHTCK4050S PLUNGER PUMP OILS GENERAL PUMP

<b>\$49.15</b>	<b>GPO100016</b>	Series 220 Oil - 16oz bottle
<b>\$75.19</b>	<b>GPO100450</b>	Series 220 Oil - 2½ gal.



### GPCW2040 DUAL SHAFT PUMP GENERAL PUMP



- FLOW: 4.0/5.0 GPM
- RPM: 1000/1250
- PSI: 2000/1500
- SHAFT OD: 24MM

**\$576.92** GPCW2040

### GPCW2040 PUMP ACCESSORIES GENERAL PUMP

<b>\$48.49</b>	<b>GPK910</b>	Low Pressure Assembly (NEW Style)
<b>\$38.90</b>	<b>GPK9101A</b>	Packing Assembly: 3 needed per pump
<b>\$66.33</b>	<b>GPK969</b>	Packing Kit: High/Low Pressure

### GPCW2040 PUMP KITS GENERAL PUMP

<b>\$42.50</b>	<b>GPK01</b>	Valve Kit
<b>\$6.66</b>	<b>GPK02</b>	Piston Rod Oil Seal
<b>\$15.88</b>	<b>GPK03</b>	Crankshaft Oil Seal
<b>\$75.83</b>	<b>GPK04</b>	Valve Caps, O-Rings
<b>\$23.25</b>	<b>GPK06</b>	Plunger Repair Kit
<b>\$83.95</b>	<b>GPK201</b>	Valve Kit Hi-Temp
<b>\$258.28</b>	<b>GPK220</b>	Seal Packing Kit

### GPCW2040 PUMP OIL GENERAL PUMP

<b>\$6.67</b>	<b>GPO100216</b>	Series 100 Oil - 16oz bottle
<b>\$81.88</b>	<b>GPO100552</b>	Series 100 Oil - 2½ gal.



## GENERAL PUMP®



### ET SERIES GENERAL PUMP



- Compact design, 5/8" hollow shaft, flanged for direct couple to electric motors (NEMA 56C), dust protection chamber, solid ceramic plungers with oversized plunger guide

ET SERIES					
PRICE	PART #	SHAFT	GPM	PSI	RPM
<b>\$283.42</b>	<b>GPET1507E34</b>	-	3.2	2610	3400



### EP SERIES GENERAL PUMP



- 24 mm solid ceramic plungers with innovative dual guide system and guide bushing for superior performance

T-50 SERIES					
PRICE	PART #	SHAFT	GPM	PSI	RPM
<b>\$339.75</b>	<b>GPEP1812S17L</b>	Left	4.0	2500	1750
<b>\$339.75</b>	<b>GPEP1812S17</b>	Right	4.0	2500	1750



### T/TS-47 SERIES GENERAL PUMP



- Solid shaft pump. Heavy duty tapered roller bearings with oversized connecting rods. 24 MM shaft, forged brass manifold

T-47 SERIES					
PRICE	PART #	SHAFT	GPM	PSI	RPM
<b>\$497.83</b>	<b>GPT1011L</b>	Left	4.5	2000	1125
			5.6	1500	1450
<b>\$497.83</b>	<b>GPT1011R</b>	Right	4.5	2000	1125
			5.6	1500	1450
<b>\$516.26</b>	<b>GPTS1011R</b>	Right	4	2000	1450
			4.75	1500	1750
<b>\$516.26</b>	<b>GPTS1011L</b>	Left	4	2000	1450
			4.75	1500	1750
<b>\$494.01</b>	<b>GPTS1511</b>	Right	4	3500	1450
<b>\$545.34</b>	<b>GPTS1511L</b>	Left	4	3500	1450
<b>\$531.60</b>	<b>GPTSS1021L</b>	Left	4.5	3000	1125
			5.6	1700	1450
<b>\$531.60</b>	<b>GPT1321L</b>	Left	5.5	2100	1150
<b>\$531.66</b>	<b>GPT1321R</b>	Right	5.5	2100	1150
<b>\$516.26</b>	<b>GPT921R</b>	Right	5	1700	1050
<b>\$516.26</b>	<b>GPT921L</b>	Left	5	1700	1050
<b>\$539.92</b>	<b>GPTS1811</b>	Right	4.5	3500	1450
			4.0	3500	1290
			5.0	3500	1610
<b>\$539.92</b>	<b>GPTS1811L</b>	Left	4.5	3500	1450
			4.0	3500	1290
			5.0	3500	1610
<b>\$516.26</b>	<b>GPT921R</b>	Right	5	1700	1050
<b>\$624.70</b>	<b>GPTS2011L</b>	Left	4	3500	1450
			4.75	2300	1750
<b>\$624.70</b>	<b>GPTS2011R</b>	Right	4	3500	1450
			4.75	2300	1750
<b>\$569.40</b>	<b>GPTS2021L</b>	Left	4.5	3500	1125
			5.6	3500	1450
<b>\$569.40</b>	<b>GPTS2021R</b>	Right	4.5	3500	1125
<b>\$842.08</b>	<b>GPT9281</b>	Right	4	4000	1750
<b>\$842.08</b>	<b>GPT9281L</b>	Left	4	4000	1750



### EZ 44 SERIES GENERAL PUMP



- Hollow shaft pump for electric direct drive, NEMA 184TC mount motor, forged brass manifold, 1 1/8" hollow shaft

EZ SERIES					
PRICE	PART #	SHAFT	GPM	PSI	RPM
<b>\$433.66</b>	<b>GPEZ2542E</b>	Right	4.2	2500	1750
<b>\$433.66</b>	<b>GPEZ2542EL</b>	Left	4.2	2500	1750
<b>\$433.66</b>	<b>GPEZ2536E</b>	Right	3.6	2500	1750
<b>\$433.66</b>	<b>GPEZ2536EL</b>	Left	3.6	2500	1750



### EP SERIES GENERAL PUMP



- Solid shaft triplex plunger pumps with forged brass manifold, solid ceramic plungers with dual guide system, optimized outlet valves and new dual lip oil seal

EP SERIES					
PRICE	PART #	SHAFT	GPM	PSI	RPM
<b>\$339.75</b>	<b>GPEP1812S17L</b>	Left	4	2500	1750
<b>\$339.75</b>	<b>GPEP1812S17</b>	Right	4	2500	1750

### GP INDUSTRIAL OIL GENERAL PUMP



SERIES 100 PUMP OIL		
<b>\$6.67</b>	<b>GP0100216</b>	16 oz. bottle
<b>\$81.88</b>	<b>GP0100552</b>	2 1/2 gal

# PUMPS

## GENERAL PUMP®



### GPCW1012 & GPCW1012L GENERAL PUMP



- FLOW: 12.0 GPM
- RPM: 900
- PRESSURE: 1000 PSI
- SHAFT OD: 35MM

<b>\$1,619.24</b>	<b>GPCW1012</b>	Right Shaft
<b>\$1,619.24</b>	<b>GPCW1012L</b>	Left Shaft
<b>\$84.04</b>	<b>GP0100734</b>	Series 8090 Oil

TO WATCH A VIDEO ABOUT THESE PUMPS VISIT OUR WEBSITE, OR SIMPLY SCAN THIS QR CODE WITH YOUR HANDHELD MOBILE DEVICE:



### GPCW3040R & GPCW3040L GENERAL PUMP



- FLOW: 5.0 GPM
- RPM: 1250
- PRESSURE: 3000 PSI
- SHAFT OD: 24MM

<b>\$661.92</b>	<b>GPCW3040R</b>	Right Shaft
<b>\$661.92</b>	<b>GPCW3040L</b>	Left Shaft

### GPCW3040R & GPCW3040L OIL GENERAL PUMP

<b>\$6.67</b>	<b>GP0100216</b>	Series 100 Oil - 16oz bottle
<b>\$81.88</b>	<b>GP0100552</b>	Series 100 Oil - 2½ gal



### GPCW2004 GENERAL PUMP



- FLOW: 4.0 GPM
- RPM: 1750
- PRESSURE: 2000 PSI
- SHAFT OD: 24MM

<b>\$671.06</b>	<b>GPCW2004</b>	Right Shaft
<b>\$671.06</b>	<b>GPCW2004L</b>	Left Shaft

### GPCW2004 OIL GENERAL PUMP

<b>\$6.67</b>	<b>GP0100216</b>	Series 100 Oil - 16 oz bottle
<b>\$81.88</b>	<b>GP0100552</b>	Series 100 Oil - 2½gal

## GENERAL PUMP® SUPPLIES, OIL & KITS

### GP INDUSTRIAL OIL GENERAL PUMP



- Pump crankcase oil must be changed after an initial 50-hour break-in period. Oil must be changed every 3 months or 500 hour intervals thereafter



### 100 SERIES OIL GENERAL PUMP®

- For use with these General Pumps:

All Emperor Series Except HTCK4050S and HTCK3623S	
All T50 Series	GPCW2040
All T47 Series	GPCW3040R
All EZ44 Series	GPCW3040L

<b>\$81.88</b>	<b>GP0100552</b>	2½ Gallon
<b>\$6.67</b>	<b>GP0100216</b>	16 oz. bottle

### 8090 SERIES OIL GENERAL PUMP®

- For use with these General Pumps:

GPCW61
GPCW1012L
GPCW61L

<b>\$84.04</b>	<b>GP0100734</b>	2½ Gal.
----------------	------------------	---------

### 220 SERIES OIL GENERAL PUMP®

- For use with these General Pumps:

GPHTCK4050S
GPHTCK3623S

<b>\$75.19</b>	<b>GP0100450</b>	2½ Gal.
----------------	------------------	---------

### OTHER GP KITS GENERAL PUMP



<b>\$44.44</b>	<b>GPK08</b>	20MM High Pressure Seals
<b>\$31.12</b>	<b>GPK28</b>	20MM Packing Assembly
<b>\$91.92</b>	<b>GPK80</b>	45MM Packing Assembly



### PULLEYS GENERAL PUMP



<b>\$43.03</b>	<b>GPP639015</b>	1 Groove - 8" - 24MM
<b>\$45.14</b>	<b>GPPZP140</b>	2 Groove - 5½" - 24MM
<b>\$45.14</b>	<b>GPPZP160</b>	2 Groove - 6¾" - 24MM





## CW2040 GENERAL PUMP

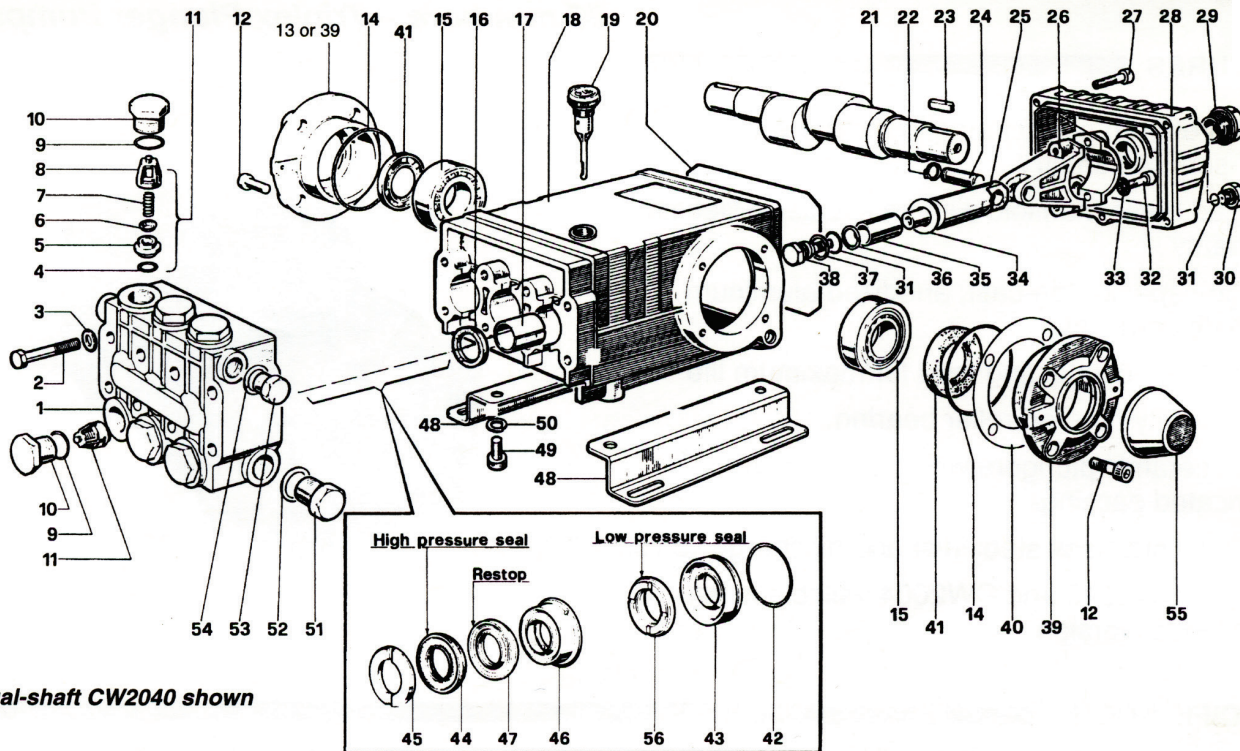

Dual-shaft CW2040 shown

### PARTS LIST

ITEM	PART NO.	DESCRIPTION	KIT NO.	QTY.	ITEM	PART NO.	DESCRIPTION	KIT NO.	QTY.	ITEM	PART NO.	DESCRIPTION	KIT NO.	QTY.
1.	47.1208.41	Manifold		1	20.	47.2119.84	Cover, Gasket		1	38.	47.2195.66	Screw, Plunger	6, 107	3
	47.1201.41	Manifold (CW24)			21.	47.0216.35	Crankshaft - dual (CW2040)		1	39.	47.1500.22	Cover, Crankcase		2
2.	99.3206.00	Screw, M8 x 70		8		47.0200.35	Crankshaft (CW24)			40.	97.5678.00	Shim		2
3.	96.7020.00	Washer, M8.4		8		47.0217.35	Crankshaft (CW3040)			41.	90.1648.00	Seal, Oil	3	2
4.	90.3841.00	O-Ring, .674 x .103	K01	6		47.0214.35	Crankshaft (CW2004)			42.	90.3616.00	O-Ring, 1.364 x .070	10,9101A,910	3
5.	36.2003.66	Seat, Valve	K01	6	22.	90.0557.00	Ring, Snap, M12		6	43.	47.0809.70	Retainer, Seal, Low Press	10,9101A,910	3
6.	36.2001.76	Plate, Valve	K01	6	23.	91.4890.00	Key		1	44.	90.2705.00	Seal, High Pressure	969,9101A	3
7.	94.7376.00	Spring	K01	6	24.	97.7380.00	Pin, Wrist		3	45.	47.1000.51	Ring, Head, M20	7, 9101A	3
8.	36.2002.51	Guide, Valve	K01	6	25.	47.0504.54	Guide, Piston		3	46.	47.2169.70	Ring, Intermed., M20	71,9101A	3
9.	90.3847.00	O-Ring, .797 x .103	4	6	26.	47.0300.01	Rod, Connecting		3	47.	90.2704.00	Ring, Restop	71,969,9101A	3
10.	98.2220.00	Cap, M24	4	6	27.	99.1837.00	Screw, M6 x 14		5	48.	47.2000.74	Rail, Pump		2
11.	36.7032.01	Valve Assembly	K01	6	28.	47.1603.22	Cover, Crankcase		1	49.	99.3644.00	Screw, M10 x 18		4
12.	99.3039.00	Screw, M8 x 16		8		47.1600.22	Cover, Crankcase (CW24)			50.	96.7106.00	Washer, M10.2		4
13.	47.1501.22	Cover, Crankcase (CW2040 has second #39 instead)		1		47.1604.22	Cover, Crankcase (CW3040)			51.	98.2176.00	Cap		1
14.	90.3913.00	O-Ring, 2.68 x .103		2	29.	97.5968.00	Oil Indicator		1	52.	96.7514.00	Washer, M21.5		1
15.	91.8375.00	Bearing, Roller		2	30.	98.2041.00	Cap		1	53.	98.2100.00	Cap		1
16.	90.1625.00	Seal, Oil	2	3	31.	90.3585.00	O-Ring, .426 x .070	6	4	54.	96.7380.00	Washer, M17.5		1
17.	90.9126.00	Bushing		3	32.	99.3099.00	Screw, M8 x 35		6	55.	47.2123.51	Shaft Cover, Red (CW2040 only)		1
18.	47.0104.22	Crankcase		1	33.	96.7014.00	Washer, M8.4		6	56.	90.2694.00	Seal, Low Pressure	969,9101A,910	3
	47.0102.22	Crankcase (CW24)			34.	96.7286.00	Washer, M14	6, 107	3	Optional				
19.	98.2106.00	Oil Dip Stick		1	35.	47.0404.09	Plunger, (20 mm)		3	190160	Rail & Coupler Kit (310)		1	
					36.	90.5067.00	Ring, Back-up	6, 107	3	190161	Rail & Coupler Kit (530)		1	
					37.	96.7280.00	Washer, M14	6, 107	3					

### REPAIR KITS

KIT NO.	K01	2	3	4	6	7	10	71	969	9101A	910
ITEM NO.s INCLUDED IN KIT	4,5,6,7,8 (11)	16	41	9, 10	31, 34, 36, 37, 38	45	42, 43	46, 47	44, 47, 56	42, 43, 44, 45, 46, 47, 56	42, 43, 56
NUMBER OF ASSEMBLIES IN KIT	6	3	2	6	3	6	3	3	3	1	3
NUMBER OF CYLINDERS KIT WILL SERVICE	6	3	-	3	3	3	3	3	3	1	3

### TORQUE SPECS\*

Position	Ft.-lbs.
2	22.1
10	73.7
12	14.7
27	7.3
29	13.2
30	14.7
32	14.7
38	14.7
49	29.4
51	29.4

\*Decrease torque by 20% if threads are lubricated.



# PUMPS

## GENERAL PUMP® SUPPLIES, OIL & KITS FROM KLEEN-RITE



### REPAIR KIT FOR GENERAL PUMP EZ3040G

KLEEN-RITE KITS

**• KIT WILL SERVICE EZ3040G PUMPS**

- Packing assemblies, valves, and oil are genuine General Pump® replacement parts
- (1) K88 Seal Kit
- (1) 100216 16 oz. General Pumps® Oil
- (1) K123 Valve Kit
- (1) 36H993 Large Size Coated Nitrile Gloves

**\$85.72** KRK2201



### REPAIR KIT FOR GENERAL PUMP EZ4040G

KLEEN-RITE KITS

**• KIT WILL SERVICE EZ4040G PUMPS**

- Packing assemblies, valves, and oil are genuine General Pump® replacement parts
- (1) K153 Seal Kit
- (1) 100216 16 oz. General Pumps® Oil
- (1) K123 Valve Kit
- (1) 36H993 Large Size Coated Nitrile Gloves

**\$134.88** KRK2202



### REPAIR KIT FOR GENERAL PUMP TS1511 & TS2021

KLEEN-RITE KITS

**• KIT WILL SERVICE TS1511 & TS2021 PUMPS**

- Packing assemblies, valves, and oil are genuine General Pump® replacement parts
- (1) K69 Packing Kit
- (1) 100216 16 oz. General Pumps® Oil
- (1) K01 Valve Kit
- (1) 36H993 Large Size Coated Nitrile Gloves

**\$101.14** KRK2203



### REPAIR KIT FOR GENERAL PUMP TS1511 & TS2021 WITH BRASS

KLEEN-RITE KITS

**• KIT WILL SERVICE TS1511 & TS2021 PUMPS WITH BRASS**

- Packing assemblies, valves, and oil are genuine General Pump® replacement parts
- (3) K28 Packing Kit
- (3) 100216 16 oz. General Pumps® Oil
- (1) K01 Valve Kit
- (1) 36H993 Large Size Coated Nitrile Gloves

**\$123.75** KRK2204

## PENTAIR HYPRO PUMP ACCESSORIES



### PULSE HOSE

PENTAIR HYPRO ACCESSORIES 

- Quality pulsation dampener hoses constructed of special Hi-Flex horizontally-braided hose.
- **MAX. PRESSURE:** 1500 PSI
- **MEASUREMENTS:** 3/8" x 24"

**\$26.18** HYP33750012



### PUMP OIL

PENTAIR HYPRO ACCESSORIES 

- Specially-formulated SAE 30 weight, non-detergent, high-grade oil
- Reduces scuff and wear in diaphragm, piston, and plunger pumps
- Inhibits moisture that causes damage
- Prevents oxidation that could lead to sludge formation
- Resists foaming and aeration that can cause equipment to operate erratically and oil to oxidize
- Provides smooth pump operation in a variety of temps.

**\$11.77** HY00038 1 Quart

ALL PENTAIR BRANDS ARE TRADEMARKS OF PENTAIR.

## GIANT PLUNGER PUMPS

### PLUNGER PUMPS

#### GIANT PUMPS

- Ceramic plungers
- Stainless steel and brass wetted parts
- Dipstick for easy oil level inspection
- Large drain plug for easy oil change and maintenance

- Self-adjusting, spring-loaded Packings
- Corrosion-resistant Hastalloy valves for longer life
- Heavy-duty ball bearings
- Mounting rails are not included with pumps

- Brass or aluminum/bronze fluid ends
- Compact design for easy fit
- Die-cast aluminum crankcase

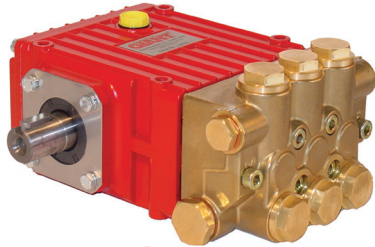

### PUP318AL & PUP318AR GIANT PLUNGER PUMPS



- **MAX FLOW:** 5.8 GPM
- **MAX RPM:** 1750
- **INLET:** (2) 1/2" BSP
- **MAX PRESSURE:** 1000 PSI
- **DISCHARGE:** (2) 3/8" BSP

### PUP318AL & PUP318AR KITS GIANT PLUNGER PUMPS

<b>\$48.93</b>	<b>PU09145</b>	Plunger Packing
<b>\$54.47</b>	<b>PU09116</b>	Valve Kit
<b>\$27.93</b>	<b>PU01161</b>	Rails

<b>\$525.15</b>	<b>PUP318AL</b>	Left Shaft
<b>\$521.54</b>	<b>PUP318AR</b>	Right Shaft

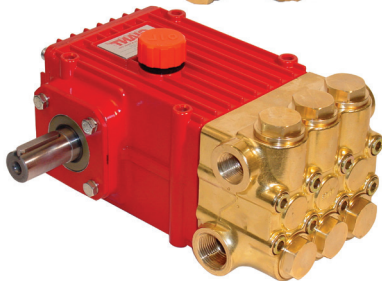

### PUP420A GIANT PLUNGER PUMPS



- **MAX FLOW:** 12.8 GPM
- **MAX RPM:** 1450
- **INLET:** (2) 1" NPT
- **MAX PRESSURE:** 2175 PSI
- **DISCHARGE:** (2) 3/4" NPT

### PUP420A REPAIR KITS GIANT PLUNGER PUMPS

<b>\$118.27</b>	<b>PU09140</b>	Plunger Packing
<b>\$264.14</b>	<b>PU09143</b>	Valve Kit
<b>\$42.95</b>	<b>PU07358</b>	Rails

<b>\$1,270.25</b>	<b>PUP420AL</b>	Left
<b>\$1,361.05</b>	<b>PUP420AR</b>	Right

## GIANT LP SERIES PUMPS

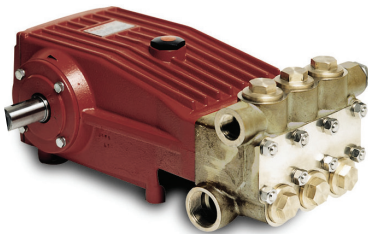

### PULP122 GIANT LP SERIES PUMPS



- **MAX FLOW:** 35.4 GPM
- **MANIFOLD:** Alum/Bronze
- **INLET:** (2) 1 1/2" NPT
- **MAX PRESSURE:** 1300 PSI
- **MAX RPM:** 800
- **DISCHARGE:** (2) 1" NPT

### PULP122 KITS GIANT LP SERIES PUMPS

<b>\$264.57</b>	<b>PU09477</b>	Plunger Packing
<b>\$305.35</b>	<b>PU09136</b>	Valve Kit

**\$4,158.07** **PULP122** **USES RECLAIMED WATER**

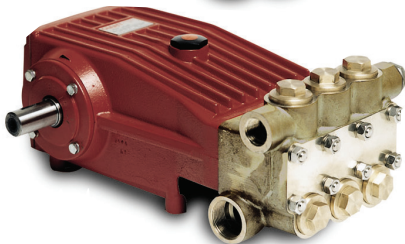

### PULP123 GIANT LP SERIES PUMPS



- **MAX FLOW:** 35.4 GPM
- **MAX RPM:** 800
- **MANIFOLD:** Brass
- **MAX PRESSURE:** 1300 PSI
- **INLET:** (2) 1 1/2" NPT

- **MAX TEMP:** 140° F.
- **DISCHARGE:** (2) 1" NPT

**\$3,369.32** **PULP123** **USES FRESH WATER**

## GIANT PUMPS

### PUP220E SERIES GIANT PUMPS



- Can include flange and coupler for direct mounting, direct drive fits 184TC face motor
- **MAX FLOW:** 4.7 GPM
- **MAX RPM:** 1750
- **MAX PRESSURE:** 2000 PSI
- **INLET:** (2) 1/2" BSP
- **MAX TEMP:** 160° F.
- **DISCHARGE:** (2) 3/8" BSP

<b>\$390.69</b>	<b>PUP220R</b>	Right Shaft	-
<b>\$390.69</b>	<b>PUP220L</b>	Left Shaft	-
<b>\$417.49</b>	<b>PUP220LE1B</b>	Left Shaft	56C Electric Motor • 5/8"
<b>\$417.49</b>	<b>PUP220RE1B</b>	Right Shaft	56C Electric Motor • 5/8"
<b>\$481.37</b>	<b>PUP220RE1BUT</b>	Right Shaft	56C Electric Motor • 5/8" with Unloader, Thermal
<b>\$429.85</b>	<b>PUP220RE2F</b>	Right Shaft	56C Electric Motor • 1 1/8"
<b>\$429.85</b>	<b>PUP220RE2</b>	Right Shaft	TC Face Electric Motor
<b>\$429.85</b>	<b>PUP220RE2F</b>	Right Shaft	TC Face Electric Motor • 1 1/8"
<b>\$489.20</b>	<b>PUP220RE2FU</b>	Right Shaft	TC Face Electric Motor • 1 1/8" with Unloader
<b>\$494.47</b>	<b>PUP220RE2FU3T</b>	Right Shaft	TC Face Electric Motor • 1 1/8" with Unloader 2.1mm Fixed Siphon Injector, Thermal

### PUP220E KITS GIANT PUMPS

<b>\$57.55</b>	<b>PU09164</b>	Plunger Packing
<b>\$54.47</b>	<b>PU09116</b>	Valve Kit

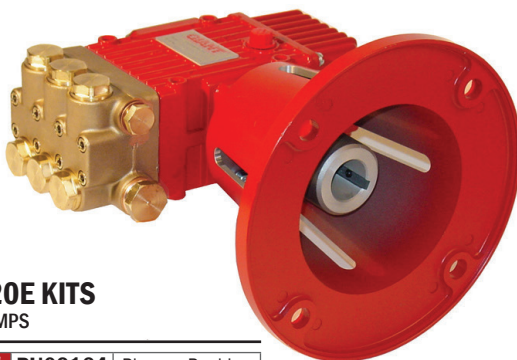

# PUMPS

## GIANT PUMPS



**PUP46W**  
GIANT PUMPS

- MAX FLOW: 3.9 GPM
- MAX TEMP: 160° F.
- INLET: (2) 1/2" BSP
- MAX PRESSURE: 2200 PSI
- MAX RPM: 1420
- DISCHARGE: (2) 3/8" BSP

**\$596.14** PUP46W



**PUP46W KITS**  
GIANT PUMPS

<b>\$110.51</b>	<b>PU09081</b>	Plunger Packing
<b>\$130.15</b>	<b>PU09039</b>	Valve Kit
<b>\$48.57</b>	<b>PU01075</b>	Rails

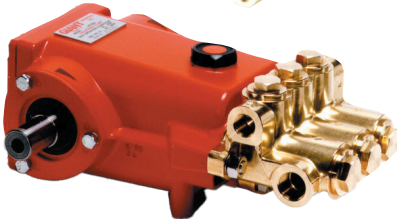

**PUP55W**  
GIANT PUMPS

- MAX FLOW: 4.9 GPM
- MAX TEMP: 160° F.
- INLET: (2) 1/2" NPT
- MAX PRESSURE: 2320 PSI
- MAX RPM: 1750
- DISCHARGE: (2) 3/8" NPT

**\$762.82** PUP55W



**PUP55W KITS**  
GIANT PUMPS

<b>\$109.91</b>	<b>PU09089</b>	Plunger Packing
<b>\$115.12</b>	<b>PU09041</b>	Valve Kit
<b>\$48.57</b>	<b>PU01075</b>	Rails



**PUP56W**  
GIANT PUMPS

- MAX FLOW: 6.1 GPM
- MAX TEMP: 160° F.
- INLET: (2) 1/2" NPT
- MAX PRESSURE: 1900 PSI
- MAX RPM: 1420
- DISCHARGE: (2) 3/8" NPT

**\$743.59** PUP56W



**PUP56W KITS**  
GIANT PUMPS

<b>\$115.93</b>	<b>PU09061</b>	Plunger Packing
<b>\$115.12</b>	<b>PU09041</b>	Valve Kit
<b>\$48.57</b>	<b>PU01075</b>	Rails

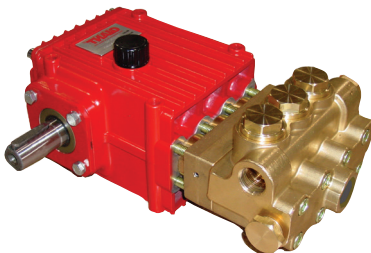

**PUP470**  
GIANT PUMPS

- MAX FLOW: 18.4 GPM
- MAX RPM: 1450
- MAX PRESSURE: 2030 PSI
- INLET: (1) 1" BSPP & (2) X 3/4" BSPP
- MAX TEMP: 160° F.
- DISCHARGE: (2) 3/4" BSPP

<b>\$1,632.02</b>	<b>PUP470R</b>	Right Shaft
<b>\$1,632.02</b>	<b>PUP470L</b>	Left Shaft

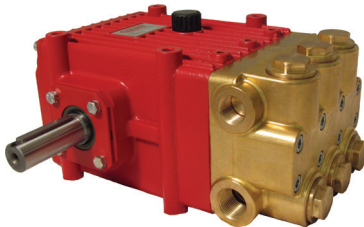

**PUP536**  
GIANT PUMPS

- MAX FLOW: 26.4 GPM
- MAX RPM: 1450
- MAX PRESSURE: 1740 PSI
- INLET: (2) 1" BSP
- MAX TEMP: 104° F.
- DISCHARGE: (2) 3/4" BSP

<b>\$8,015.07</b>	<b>PUP536R</b>	Right Shaft
<b>\$8,015.07</b>	<b>PUP536L</b>	Left Shaft



## GIANT PUMPS PARTS



**STAINLESS STEEL ACCUMULATOR**  
GIANT PUMPS

<b>\$139.04</b>	<b>PU22050-38</b>	12 GPM	3000 PSI	3/8" FNPT	
<b>\$92.70</b>	<b>PU22050</b>	12 GPM	3000 PSI	1/2" MNPT	
<b>\$156.62</b>	<b>PU22155</b>	30 GPM	3000 PSI	3/8" FNPT	



**GIANT PUMPS CRANKCASE OIL**  
GIANT PUMPS

<b>\$40.83</b>	<b>PU01154</b>	1 Gallon 80-90
<b>\$12.18</b>	<b>PU01153</b>	1 Quart 20W-50

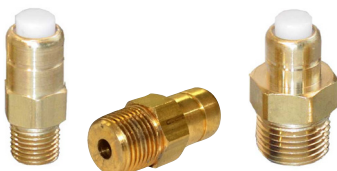

**THERMAL RELIEF VALVES**  
GIANT PUMPS

<b>\$5.80</b>	<b>PU23420</b>	1/4"	140°
<b>\$5.80</b>	<b>PU23421</b>	3/8"	140°
<b>\$5.57</b>	<b>PU23422</b>	1/2"	140°



View our complete listing of Giant Pump parts and accessories at

**KLEENRITE.COM**



# HYDRA-CELL PUMPS

## FROM WANNER ENGINEERING, INC.

Hydra-Cell positive displacement pumps have an incredibly efficient design that nearly eliminates maintenance and helps the pumps last longer – even when processing difficult liquids that contain abrasives and particulates! Each Hydra-Cell pump is engineered without seals, packing or cups, and boast hydraulically balanced diaphragms that aren't stressed while flexing.

- Made with tough, durable materials
- Virtually no maintenance: low stress, hydraulically balanced, sealless design
- Highly efficient with low power consumption
- Self-priming
- Capable of running dry
- Handles the full spectrum of low - high viscosity fluids
- Low vibration often eliminates the need for pulsation dampeners

### KEY DETAILS OF HYDRA-CELL DISPLACEMENT PUMPS

#### RIGID ROLLER BEARINGS

Lubricated by oil bath

#### FIXED ANGLE CAM

Rotary motion translated to linear

#### HYDRAULIC CELLS

Displace diaphragms with pressurized oil

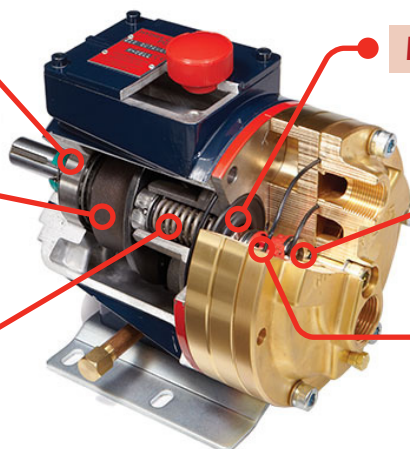

#### HYDRAULICALLY BALANCED DIAPHRAGMS

Capable of flexing without damage

#### INLET VALVE ASSEMBLIES

Guide liquid into pumping chamber

#### OUTLET VALVE ASSEMBLIES

Guide liquid into discharge lines

### HYDRA-CELL SERIES OPTIONS

Hydra-Cell pumps are useful in applications like car washes, agriculture, and landscaping. There are several different series of Hydra-Cell pumps available that satisfy different pressure and flow rate needs. Popular series include the H-25 Series and the D-10 Series.

#### H-25 SERIES PUMP

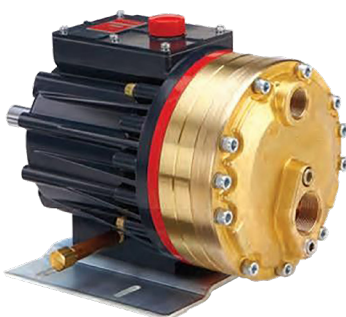

- **FLOW:** 20 GPM
- **PRESSURE:** 1000 PSI
- **INLET:** 1½" NPT
- **OUTLET:** 1" NPT
- **MAX. TEMP:** 180° F

H25XKBTHFECA MODEL SHOWN

#### D-10 SERIES PUMP



- **FLOW:** 8.8 GPM
- **PRESSURE:** 1000 PSI
- **INLET:** 1" NPT
- **OUTLET:** ¾" NPT
- **MAX. TEMP:** 180° F

D10EKBTHFECA MODEL SHOWN

# FEATURED PRODUCT

## HYDRA-CELL PUMPS

### HYDRA-CELL PUMPS WANNER ENGINEERING

HYDRA-CELL®  
SEAL-LESS PUMP TECHNOLOGIES

- For difficult solutions like reclaim water, wettable powders, slurries & abrasives. Solutions never come in contact with pumping mechanisms. Diaphragm design has no cups, packing or mechanical seals
- American made
- Positive displacement pumps
- Can be run dry without damage
- Hydraulically balanced diaphragms
- Timken roller bearings
- Shaft direction can be in either direction for easy mounting
- Brass pump heads
- Buna-N elastomers
- Stainless steel valves, seats, & valve springs



### D35-X HYDRA-CELL PUMPS

HYDRA-CELL®  
SEAL-LESS PUMP TECHNOLOGIES

- **MAX FLOW:** 37.0 GPM
- **MAX RPM:** 1050
- **INLET:** 2½" NPT
- **MAX PRESSURE:** 1250 PSI
- **SHAFT DIAMETER:** 2"
- **OUTLET:** 1¼" NPT
- **MAX TEMP:** 180° F.
- **SHAFT ROTATION:** Bi-directional
- **WEIGHT:** 240 lbs.

<b>\$5,866.19</b>	<b>WPD35XKBTH</b>	Pump
<b>\$428.14</b>	<b>D35K52THFEC</b>	Repair Kit

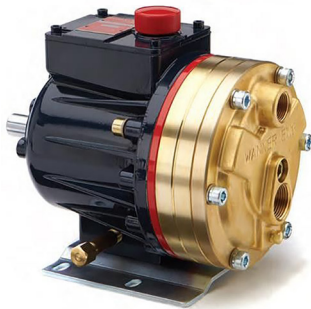

### D10-X (BELT DRIVEN) HYDRA-CELL PUMPS

HYDRA-CELL®  
SEAL-LESS PUMP TECHNOLOGIES

- **MAX FLOW:** 8.1 GPM
- **MAX RPM:** 1450
- **INLET:** 1" NPT
- **MAX PRESSURE:** 1000 PSI
- **SHAFT DIAMETER:** 7/8"
- **OUTLET:** 3/4" NPT
- **MAX TEMP:** 180° F.
- **SHAFT ROTATION:** Bi-directional
- **WEIGHT:** 48 lbs.

<b>\$1,370.85</b>	<b>D10XKBTHFECA</b>	Pump
<b>\$198.76</b>	<b>D10K52THFEC</b>	Repair Kit

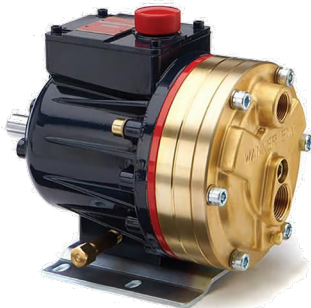

### D10-E (DIRECT DRIVE) HYDRA-CELL PUMPS

HYDRA-CELL®  
SEAL-LESS PUMP TECHNOLOGIES

- **MAX FLOW:** 8.8 GPM
- **MAX RPM:** 1750
- **INLET:** 1" NPT
- **MAX PRESSURE:** 1000 PSI
- **SHAFT DIAMETER:** 7/8"
- **OUTLET:** 3/4" NPT
- **MAX TEMP:** 180° F.
- **SHAFT ROTATION:** Bi-directional
- **WEIGHT:** 48 lbs.

<b>\$1,370.85</b>	<b>WPD10EKBTH</b>	Pump
<b>\$198.76</b>	<b>D10K52THFEC</b>	Repair Kit



### H25-X HYDRA-CELL PUMPS

HYDRA-CELL®  
SEAL-LESS PUMP TECHNOLOGIES

- **MAX FLOW:** 20 GPM
- **MAX RPM:** 1050
- **INLET:** 1½" NPT
- **MAX PRESSURE:** 1000 PSI
- **SHAFT DIAMETER:** 1½"
- **OUTLET:** 1" NPT
- **MAX TEMP:** 180° F.
- **SHAFT ROTATION:** Bi-directional
- **WEIGHT:** 125 lbs.

<b>\$3,274.14</b>	<b>WPH25XKBTH</b>	Pump
<b>\$306.88</b>	<b>D25K52THFEC</b>	Repair Kit



Hydra-Cell positive displacement pumps feature a seal-less pumping chamber so there are no seals, packing or cups to leak or replace.

The seal-less design and check valves enable Hydra-Cell to handle abrasives and particulates that would damage other types of pumps.



### HYDRA-OIL HYDRA-CELL PUMPS

HYDRA-CELL®  
SEAL-LESS PUMP TECHNOLOGIES

<b>\$11.91</b>	<b>WPOA011143430</b>	1 Qt
<b>\$81.98</b>	<b>WPOA011143432</b>	2½ Gal

## ARIMITSU PUMPS CONVERSION KITS

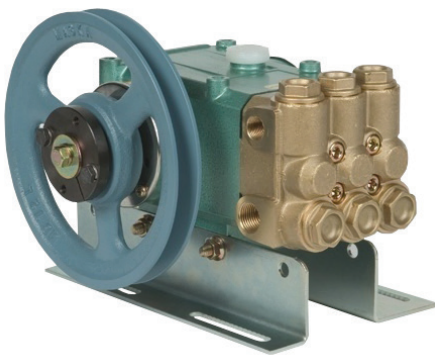

### ARIMITSU 313 SELF SERVE ARIMITSU PUMPS



- Includes 313 pump rails
- 7.2" single groove pulley
- 4.0 GPM @ 1050 RPM, 0-1500 PSI

<b>CALL</b>	<b>ARM61000</b>	Left Shaft
	<b>ARM61001</b>	Right Shaft

### MODEL 313 KITS ARIMITSU PUMPS

<b>\$97.30</b>	<b>ARM30108</b>	Valve Kit (3 Valves per kit)
<b>\$91.14</b>	<b>ARM30114</b>	Seal Kit

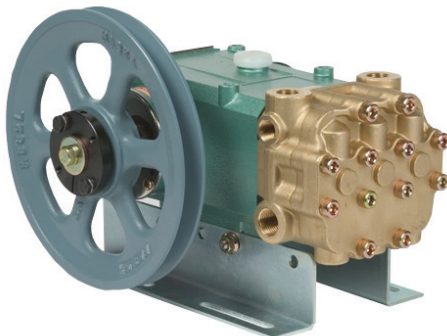

### ARIMITSU 516 SELF SERVE ARIMITSU PUMPS



- Includes 516 pump rails
- 8" single groove pulley
- 4.0 GPM @ 950 RPM, 0-2300 PSI
- 5.0 GPM @ 1200 RPM, 0-2000 PSI

<b>\$978.38</b>	<b>ARM61002</b>	Left Shaft
<b>\$978.37</b>	<b>ARM61003</b>	Right Shaft

### MODEL 516 KITS ARIMITSU PUMPS

<b>\$127.49</b>	<b>ARM30101</b>	Valve Kit (3 Valves Per Kit)
<b>\$110.57</b>	<b>ARM30100</b>	Seal Kit



### ARIMITSU 508 PREP STAND ARIMITSU PUMPS



- Includes 508 pump rails
- 9.75" double groove pulley
- 8.0 GPM @ 950 RPM, 0-1200 PSI
- 10.0 GPM @ 1200 RPM, 0-1000 PSI

<b>\$1,082.23</b>	<b>ARM61004</b>	Left Shaft
<b>\$1,053.07</b>	<b>ARM61005</b>	Right Shaft

### MODEL 508 KITS ARIMITSU PUMPS

<b>\$194.59</b>	<b>ARM30111</b>	Inlet Valve Kit
<b>\$155.55</b>	<b>ARM30112</b>	Outlet Valve Kit
<b>\$112.85</b>	<b>ARM30110</b>	Seal Kit

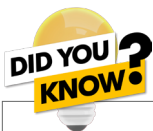

Arimitsu Pumps offer premium-quality pumps known to be quiet, durable, and compact resulting in lower energy consumption, quieter equipment rooms, and lower cost of ownership than other brands.

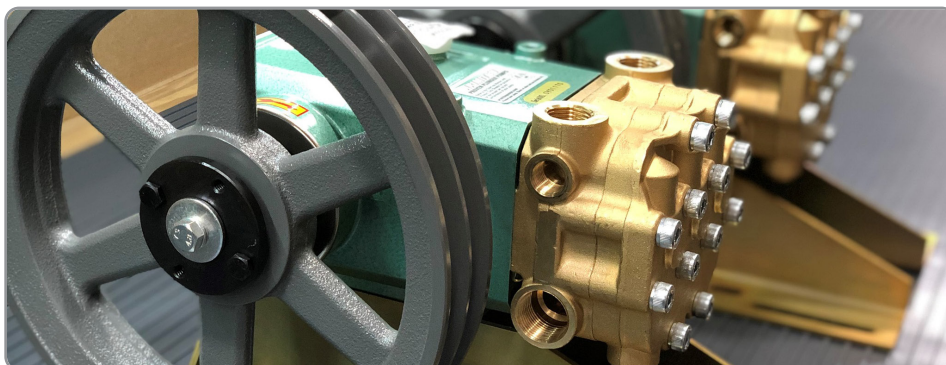

<https://www.facebook.com/arimitsupumpsofnorthamerica/photos>



## ARIMITSU PUMPS & ACCESSORIES

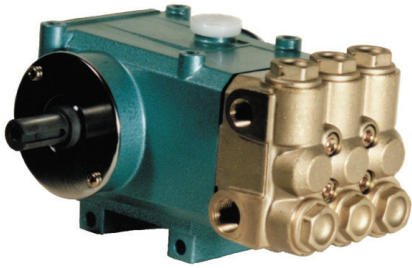

**MODEL 313**  
ARIMITSU PUMPS



- 4 GPM @ 1050 RPM, 0-1500 PSI
- Compact, quiet, durable
- Ideal for self-serve equipment
- 310/5CP replacement rails available

<b>\$705.32</b>	<b>ARM313R</b>	Right Pump
<b>\$705.32</b>	<b>ARM313L</b>	Left Pump

**MODEL 313 KITS**  
ARIMITSU PUMPS

<b>\$97.30</b>	<b>ARM30108</b>	Valve Kit (3 Valves Per Kit)
<b>\$91.14</b>	<b>ARM30114</b>	Seal Kit

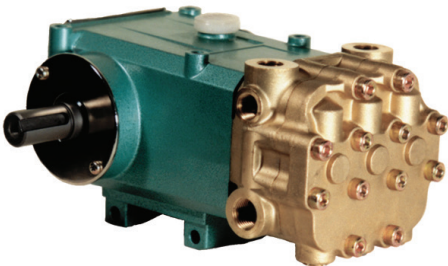

**MODEL 516**  
ARIMITSU PUMPS



- 4 GPM @ 950 RPM, 0-2300 PSI
- 5 GPM @ 1200 RPM, 0-2000 PSI
- Powerful, quiet, heavy-duty
- Ideal for truck wash or super self serve bays
- 310/5CP replacement rails available

<b>\$941.78</b>	<b>ARM516R</b>	Right Pump
<b>\$941.78</b>	<b>ARM516L</b>	Left Pump

**MODEL 516 KITS**  
ARIMITSU PUMPS

<b>\$127.49</b>	<b>ARM30101</b>	Valve Kit (3 Valves Per Kit)
<b>\$110.57</b>	<b>ARM30100</b>	Seal Kit

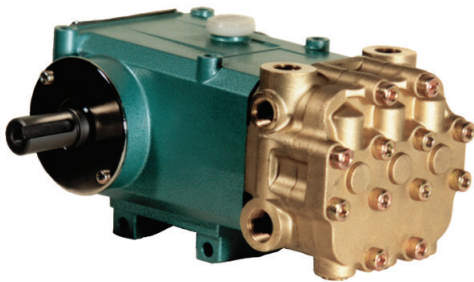

**MODEL 511**  
ARIMITSU PUMPS



- 6.5 GPM @ 1000 RPM, 0-1500 PSI
- Ideal for prep or super self serve bays

<b>\$788.42</b>	<b>ARM511R</b>	Right Pump
<b>\$788.42</b>	<b>ARM511L</b>	Left Pump

**MODEL 511 KITS**  
ARIMITSU PUMPS

<b>\$194.59</b>	<b>ARM30111</b>	Inlet Valve Kit
<b>\$155.55</b>	<b>ARM30112</b>	Outlet Valve Kit
<b>\$121.85</b>	<b>ARM30120</b>	Seal Kit

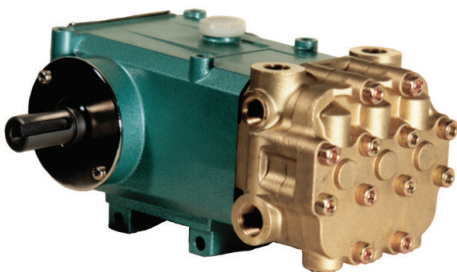

**MODEL 508**  
ARIMITSU PUMPS



- 8 GPM @ 950 RPM, 0-1200 PSI
- 10 GPM @ 1200 RPM, 0-1000 PSI
- Quiet, compact, long-lasting
- Ideal for dual-gun prep. units
- 7CP replacement rails available

<b>\$886.69</b>	<b>ARM508R</b>	Right Pump
<b>\$886.69</b>	<b>ARM508L</b>	Left Pump

**MODEL 508 KITS**  
ARIMITSU PUMPS

<b>\$194.59</b>	<b>ARM30111</b>	Inlet Valve Kit
<b>\$155.55</b>	<b>ARM30112</b>	Outlet Valve Kit
<b>\$112.85</b>	<b>ARM30110</b>	Seal Kit

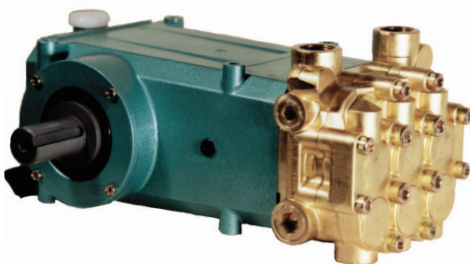

**MODEL 709**  
ARIMITSU PUMPS



- 15 GPM @ 950 RPM, 0-1100 PSI
- OEM preferred
- Compact, quiet, tough
- Standard in in-bay automatic (Mark VII)

<b>\$1,567.51</b>	<b>ARM709R</b>	Right Pump
<b>\$1,567.51</b>	<b>ARM709L</b>	Left Pump

**MODEL 709 KITS**  
ARIMITSU PUMPS

<b>\$157.55</b>	<b>ARM30106</b>	Inlet Valve Kit
<b>\$165.09</b>	<b>ARM30116</b>	Outlet Valve Kit
<b>\$100.30</b>	<b>ARM30105</b>	Seal Kit



**32 OZ. PUMP OIL**  
ARIMITSU PUMPS



- For use with all model Arimitsu pumps
- ISO100 Premium

<b>\$24.66</b>	<b>ARM30103</b>
----------------	-----------------

## ARIMITSU PUMPS

Arimitsu Pumps are perfect in applications that require low noise, compact size and durability.

## PULSAFEEDER PUMPS



### PULSATRON SERIES A PLUS PULSAFEEDER METERING PUMPS

- Reliable metering performance
- Rated "hot" for continuous duty
- High viscosity capability
- Leak-free, sealless, liquid end
- 1/4" x 3/8" OD tubing
- 1/4" FNPT piping
- 125 strokes per minute

PRICE	PART #	GPH	GPD	LPH	PSI
<b>\$407.03</b>	<b>PFLB03</b>	0.50	12	1.9	150
<b>\$362.92</b>	<b>PFLB04</b>	1.00	24	3.8	100
<b>\$412.33</b>	<b>PFLB64</b>	1.25	30	4.7	100
<b>\$402.33</b>	<b>PFLB64SAPHC1</b>	1.25	30	4.7	100



### PULSATRON SERIES C PULSAFEEDER METERING PUMPS

- Reliable metering performance
- Rated "hot" for continuous duty
- High viscosity capability
- Leak-free, sealless, liquid end
- 1/4" x 3/8" OD tubing
- 1/4" FNPT piping

PRICE	PART #	GPH	GPD	LPH	PSI
<b>\$475.86</b>	<b>PFLD03EA*</b>	0.50	12	1.9	80
<b>\$324.69</b>	<b>PFLC54SAVTC1</b>	1.25	30	4.7	80

**\*INCLUDES EXTERNAL PACING INPUT**

## PULSAFEEDER PARTS & KITS

### PULSATRON INJECTION CHECK VALVE PULSAFEEDER

- For Pulsatron and other pumps with end codes **PTC1, PTCD, PTCH, PTCJ**
- 3/8" OD tubing connection fitting with coupling nut
- 1/2" NPT male connection for the injection point

PRICE	PART #	SEAT
<b>\$72.73</b>	<b>PFJ41766</b>	FPP/HYP construction with ceramic ball
<b>\$64.47</b>	<b>PFJ41996</b>	PVC/TFE construction with ceramic ball
<b>\$76.33</b>	<b>PFJ61098</b>	FPP/FTF construction with ceramic ball



### PULSATRON VALVE ASSEMBLIES PULSAFEEDER

- Suction type valves install on the lower part of metering pump heads
- Discharge type valves install on the upper part of metering pump heads
- Bleed type valves attach to the discharge valve to facilitate pump priming

PRICE	PART #	TYPE	FOR WET END
<b>\$30.73</b>	<b>PFL3101HC1</b>	Suction	PHC1
<b>\$41.93</b>	<b>PFL3101TC1</b>	Suction	PTC1
<b>\$41.93</b>	<b>PFL3101TC1-PVC</b>	Suction	VTC1
<b>\$41.93</b>	<b>PFL3101TC3</b>	Suction	PTC3
<b>\$30.73</b>	<b>PFL3102HC3</b>	Suction	PHC3
<b>\$30.73</b>	<b>PFL3201HC1</b>	Discharge	PHC1
<b>\$30.73</b>	<b>PFL3201HC3</b>	Discharge	PHC3
<b>\$41.93</b>	<b>PFL3201TC1</b>	Discharge	PTC1
<b>\$41.93</b>	<b>PFL3201TC1-PVC</b>	Discharge	VTC1
<b>\$55.60</b>	<b>PFL3300H01-FPP</b>	Bleed	PHC1
<b>\$55.60</b>	<b>PFL3300H03-PVC</b>	Bleed	VHC3, WHC3
<b>\$55.60</b>	<b>PFL3300T01</b>	Bleed	PTCH, PTCJ, PTC1, PTT1
<b>\$55.60</b>	<b>PFL3300T03</b>	Bleed	PTCA, PTC3, PTS3, PTT3

### PULSATRON KOPKIT REPAIR KITS PULSAFEEDER

- A KOPkit is the best way to ensure proper maintenance of your Pulsafeeder metering pump
- Includes pump head assembly with valve, diaphragm, head screws, washers and an exploded view assembly drawing
- All listed kits include ceramic balls and tubing connection

PRICE	PART #	HEAD	SEATS/O-RINGS	SUCTION/DISCHARGE
<b>\$80.67</b>	<b>PFK2PHC1</b>	Size 2, GFPP	CSPE	.25" x .38"
<b>\$93.33</b>	<b>PFK3PTC1</b>	Size 3, GFPP	TFE	.25" x .38"
<b>\$93.33</b>	<b>PFK4PHC1</b>	Size 4, GFPP	CSPE	.25" x .38"
<b>\$110.00</b>	<b>PFK4PTC1</b>	Size 4, GFPP	TFE	.25" x .38"
<b>\$127.33</b>	<b>PFK4PVC1</b>	Size 4, GFPP	Viton	.25" x .38"
<b>\$110.00</b>	<b>PFK4VTC1</b>	Size 4, PVC	TFE	.25" x .38"
<b>\$127.33</b>	<b>PFK6PHC3</b>	Size 6, GFPP	CSPE	.38" x .50"
<b>\$127.33</b>	<b>PFK6PTC3</b>	Size 6, GFPP	TFE	.38" x .50"
<b>\$110.20</b>	<b>PFKX100-AAAA</b>	KOP Kit for 100, 150, 200 Pumps w/ AAAA Wet End Kits		

### PULSATRON PARTS FOR 150 PSI MODELS PULSAFEEDER

<b>\$46.73</b>	<b>PFL0200300</b>	PVC Head
----------------	-------------------	----------

### ELECTRONIC CONTROL BOARDS PULSAFEEDER

<b>\$127.47</b>	<b>PFL9906201-000</b>	Dual Function 115V, for all LD and LB Models, and LE02, 03, 12, 13, 14, 34, 33, 44
-----------------	-----------------------	--

## COMET PUMPS

### COMET HIGH PRESSURE PLUNGER PUMPS COMET POWER WASH SPRAY PUMPS



PRICE	PART #	MODEL #	GPM	PSI	RPM	GAS HP	ELECTRIC HP	SEAL KIT	VALVE KIT
<b>\$584.93</b>	<b>CP64100500</b>	FW25530S	5.5	3000	1450	10.5	11.3	<b>CP50190219</b>	<b>CP50250011</b>
<b>\$859.03</b>	<b>CP65120100</b>	TWN6036S	6	3600	1000	19.6	14.8	<b>CP50190646</b>	<b>CP50250020</b>
<b>\$859.03</b>	<b>CP65120300</b>	TWN8025S	8	2500	1000	18.2	13.7	<b>CP50190647</b>	<b>CP50250020</b>
<b>\$1,238.59</b>	<b>CP65131201</b>	TW11025S	11	2500	1450	25	18.8	<b>CP50190663</b>	<b>CP50250020</b>
<b>\$1,054.92</b>	<b>CP65140900</b>	TWS13020S	13	2000	1750	23.7	17.9	<b>CP50190647</b>	<b>CP50250020</b>
<b>\$623.27</b>	<b>CP65170900</b>	RW6030S	6.2	3000	1450	16.9	12.7	<b>CP50190672</b>	<b>CP50250025</b>



## BLUE-WHITE® PUMPS



### C-1500N SERIES INJECTION METERING PUMPS

BLUE-WHITE PUMPS

CHEM-FEED® *Blue-White*

- Ideal for dispensing precise amounts of various solutions with easy to adjust feed rate
- Weather-resistant housing for indoor or outdoor use
- Includes: 5' suction tubing with flow indicator, 5' discharge tubing, mounting hardware, foot valve and injection fitting

#### C-1500 STANDARD FEATURES:

- FKM O-ring & PTFE/EP diaphragm
- PVDF suction (foot) valve with FKM and TFE/P O-rings, ceramic check ball and removable polypropylene filter screen

#### SPECIFICATIONS

- **STROKE:** .055"
- **MAX FLOW:** 26.6 GPD
- **VOLTAGE:** 115V
- **MAX PRESSURE:** 125 PSI
- **MAX TEMP:** 130°F
- **RPM:** 45

<b>\$356.54</b>	<b>BW15N202X</b>	2.4 oz./minute	<b>\$356.54</b>	<b>BW15N304X040V7</b>	.51 oz./minute
<b>\$356.54</b>	<b>BW15N302X</b>	2.7 oz./minute	<b>\$356.54</b>	<b>BW15N332X</b>	2.7 oz./minute
<b>\$356.54</b>	<b>BW15N302X066</b>	1.4 oz./minute	<b>\$356.54</b>	<b>BW15N332X066V7</b>	1.4 oz./minute
<b>\$356.54</b>	<b>BW15N402X</b>	5.9 oz./minute	<b>\$356.54</b>	<b>BW15N432X24V</b>	5.9 oz./minute
<b>\$356.54</b>	<b>BW15N404X</b>	10.6 oz./minute			

### C-1500N SERIES INJECTION METERING PUMPS PARTS

BLUE-WHITE PUMPS

<b>\$42.57</b>	<b>BWK406VT</b>	Diaphragm Kit - FKM/PTFE
<b>\$72.97</b>	<b>BWPK5686A</b>	Bullet Valve - Pack of 2
<b>\$33.11</b>	<b>BWPC395N6A</b>	Polypropylene Injection Check Valve - for 3/8" tubing
<b>\$26.35</b>	<b>BWP340N6V</b>	Foot Valve 3/8" O.D.

## BLUE-WHITE® PUMP PARTS & ACCESSORIES

### PUMP PARTS & ACCESSORIES

BLUE-WHITE PUMPS

<b>\$42.57</b>	<b>BWK406VT</b>	FKM/PTFE Diaphragm Kit for 1500N
<b>\$26.35</b>	<b>BWP340N6V</b>	Foot Valve - 3/8" O.D. (C-340A)
<b>\$20.27</b>	<b>BWPC5606V</b>	3/8" O.D. Adapter - FKM O-Ring Housing
<b>\$20.27</b>	<b>BWPK568V1</b>	Bullet Valve (sold in single packs) (K-568A)
<b>\$28.38</b>	<b>BWP7618</b>	10' Tubing With Flow Indicator - 3/8" O.D.
<b>\$20.94</b>	<b>BWP7638</b>	5' Tubing With Flow Indicator - 3/8" O.D.
<b>\$33.11</b>	<b>BWPC395N6A</b>	Polypropylene Injection Check Valve for 3/8" tubing

### C-1700N SERIES PUMP PARTS

BLUE-WHITE PUMPS

<b>\$33.11</b>	<b>BWPC395N6A</b>	Polypropylene Injection Check Valve - for 3/8" tubing
<b>\$42.57</b>	<b>BWK406VT</b>	Diaphragm Kit KFM/PTFE
<b>\$72.97</b>	<b>BWPK5686A</b>	Bullet Valve - Pack of 2



**BWPK568V1**



**BWPC5606V**



**BWPC395N6A**



**BWK406VT**



**BWP340N6V**



**BWP7618**  
(10 FOOT LENGTH)

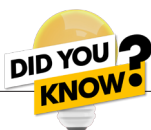

Established in 1957, Blue-White started out with a focus on the pool industry, but has grown over time to become a leading innovator in pumps for all purposes. All Blue-White Industries products are proudly made in the United States, at their central manufacturing facility in California. With in-house CNC capabilities and multiple Quality Assurance departments, Blue-White brings you homegrown quality you can count on!



## ETATRON PUMPS



### ELECTRIC DIAPHRAGM METERING PUMP

ETATRON FROM DILUTION SOLUTIONS

**Dilution™**  
SOLUTIONS

- Ideal for dispensing precise amounts of various solutions
- Simple-to-use, highly reliable and provides a compact design
- Great for accurate injections with presoaks, detergents, waxes and drying aids
- Unique one-piece Teflon® diaphragm

**STANDARD FEATURES:**

- Adjustable during operation
- Can handle applications up to 140° F
- Wall and base mounting option
- 24 or 120V - 50/60 Hz
- IP65 acid-resistant housing

- Flashing LED indicator during operation
- Manual air bleed pump head facilitates faster priming
- Automatic suction shut-off when de-powered
- Fully adjustable 0-100% range
- Polypropylene housing

**CONSTRUCTION:**

- Pump Head: Polypropylene
- Suction Tube: PVC
- Seals: Viton

- Diaphragm: Teflon®
- Valves: Viton
- Discharge Tube: Polyethylene

**DIMENSIONS:**

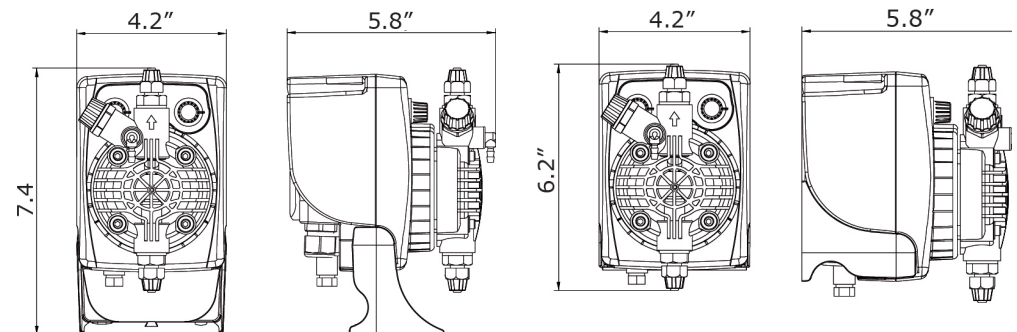

BASE MOUNT

WALL MOUNT

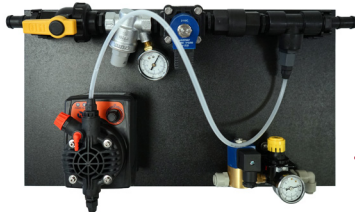

PRICE	PART #	ETATRON #	FLOW	PRESSURE	VOLTAGE
<b>\$263.71</b>	<b>EP107510</b>	PKX0107510EA	.55 oz/minute	72 PSI	120V
<b>\$258.35</b>	<b>EP129010</b>	PKX0129010EA	1.13 oz/minute	87 PSI	120V
<b>\$258.34</b>	<b>EP108510</b>	PKX0108510EA	2.82 oz/minute	72 PSI	120V
<b>\$289.71</b>	<b>EP114601</b>	PKX0114601EA	.55 oz/minute	72 PSI	24V
<b>\$285.18</b>	<b>EP129401</b>	PKX0129401EA	1.13 oz/minute	87 PSI	24V
<b>\$285.18</b>	<b>EP129801</b>	PKX0129801EA	2.82 oz/minute	72 PSI	24V

EXAMPLE OF FOAMING SYSTEM INSTALLATION USING THE PKX PUMP



### 33" CHEMSTICK WITH BUNG ADAPTER

DILUTION SOLUTIONS

**Dilution™**  
SOLUTIONS

The Dilution Solutions CS33 ChemStick is chemical- and acid-resistant, thanks to its polypropylene construction and Viton seals. Keep unwanted particulates out of your chemical system - bung adaptor prevents debris from entering drum after installation, while adjustable depth of ChemStick avoids sucking up debris that has settled at the bottom of the chemical barrel. Hastelloy strainer prevents particulates from being extracted during pumping, and is easy to access for cleaning. Check valve helps prevent any back flow, keeping other liquids out of the barrel.

**SPECIFICATIONS & INFORMATION:**

- 33" length reaches bottom of most 55-gallon drums
- Adjustable stopper makes it easy to set depth for pipe
- Includes foot spacer and foot valve
- 4 polypropylene hose barbs included: 1/4", 3/8", 1/2", and 3/4"

**\$104.85**    **CS33**

# PUMPS

## LITTLE GIANT® PUMPS

### MAGNETICALLY DRIVEN PUMPS

LITTLE GIANT PUMPS

LittleGIANT®

- The MD Series features leakproof, seal-less magnetic drives and are designed for in-line, non-submersed use. Open fan-cooled motor has sleeve bearings and is thermally protected.

#### FOR MILDLY CORROSIVE CHEMICALS



#### LGP2MD

LITTLE GIANT PUMPS

LittleGIANT

- **MOTOR:** 1/30 HP Open FC
- **MAX PRESSURE:** 6.3 PSI
- **OUTLET PORTS:** 1/2" MNPT
- **INLET PORTS:** 1/2" FNPT

- **FLOW:** 8.2 GPM
- **MAX TEMP:** 150°F
- **VOLTAGE:** 115V
- **RPM:** 3100

**\$247.83** LGP2MD

#### LGP3MD

LITTLE GIANT PUMPS

LittleGIANT

- **MOTOR:** 1/20 HP Open FC
- **MAX PRESSURE:** 7 PSI
- **OUTLET PORTS:** 1/2" MNPT
- **INLET PORTS:** 1/2" FNPT

- **FLOW:** 9.1 GPM
- **MAX TEMP:** 150°F
- **VOLTAGE:** 115V
- **RPM:** 3300

**\$299.67** LGP3MD

#### FOR SEMI-CORROSIVE CHEMICALS



#### LGP2MDSC

LITTLE GIANT PUMPS

LittleGIANT

- **MOTOR:** 1/25 HP Open FC
- **MAX PRESSURE:** 6.3 PSI
- **OUTLET PORTS:** 1/2" MNPT
- **INLET PORTS:** 1/2" FNPT

- **FLOW:** 6.85 GPM
- **MAX TEMP:** 150°F
- **VOLTAGE:** 115V
- **RPM:** 2900

**\$280.61** LGP2MDSC

#### LGP3MDSC

LITTLE GIANT PUMPS

LittleGIANT

- **MOTOR:** 1/12 HP Open FC
- **MAX PRESSURE:** 9.5 PSI
- **OUTLET PORTS:** 1/2" MNPT
- **INLET PORTS:** 3/4" FNPT

- **FLOW:** 11.0 GPM
- **MAX TEMP:** 150°F
- **VOLTAGE:** 115V
- **RPM:** 3100

**\$327.48** LGP3MDSC

#### FOR HIGHLY CORROSIVE CHEMICALS

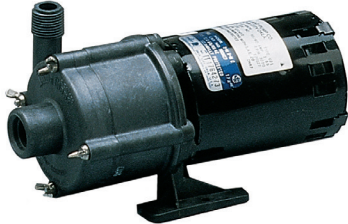

#### LGP2MDHC

LITTLE GIANT PUMPS

LittleGIANT

- **MOTOR:** 1/30 HP Open FC
- **MAX PRESSURE:** 6.3 PSI
- **OUTLET PORTS:** 1/2" FNPT
- **INLET PORTS:** 1/2" MNPT

- **FLOW:** 8.5 GPM
- **MAX TEMP:** 200°F
- **VOLTAGE:** 115V
- **RPM:** 3100

**\$352.79** LGP2MDHC

#### LGP3MDHC

LITTLE GIANT PUMPS

LittleGIANT

- **MOTOR:** 1/12 HP Open FC
- **MAX PRESSURE:** 9.5 PSI
- **OUTLET PORTS:** 1/2" MNPT
- **INLET PORTS:** 3/4" FNPT

- **FLOW:** 11.0 GPM
- **MAX TEMP:** 200°F
- **VOLTAGE:** 115V
- **RPM:** 3100

**\$426.11** LGP3MDHC

## LITTLE GIANT® SUBMERSIBLE PUMPS



#### LGPNK1

LITTLE GIANT PUMPS

LittleGIANT

- **MOTOR:** 1/150 HP Oil-Filled
- **MAX PRESSURE:** 4.4 PSI
- **OUTLET PORTS:** 1/4" MNPT

- **FLOW:** 210 GPH
- **MAX TEMP:** 120°F
- **VOLTAGE:** 115V

**\$131.64** LGPNK1

#### LGPNK2

LITTLE GIANT PUMPS

LittleGIANT

- **MOTOR:** 1/40 HP Oil-Filled
- **MAX PRESSURE:** 5.3 PSI
- **OUTLET PORTS:** 1/4" MNPT

- **FLOW:** 325 GPH
- **MAX TEMP:** 120°F
- **VOLTAGE:** 115V

**\$168.18** LGPNK2

## LITTLE GIANT® SPECIALTY PUMPS

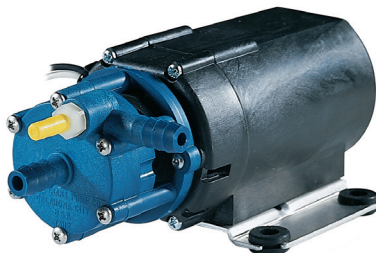

#### LGP350M SPECIALTY PUMP

LITTLE GIANT PUMPS

LittleGIANT

- Non-submersible, high-pressure pump for carpet cleaners, dispenser-displays and pressure-washer applications
- **FLOW RATE:** 170 GPH @ 10'
- **MAX FLOW:** 2.75 GPM
- **INTAKE/ DISCHARGE:** 3/8" Barbed OD
- **MAX PRESSURE:** 37.7 PS
- **VOLTAGE:** 115V
- **MAX TEMP:** 120°F

**\$228.24** LGP350M

## PROCON® PUMPS

### ROTARY VANE PUMPS

PROCON PRODUCTS

- Excellent for tire cleaner, presoak, spot-free RO water, and foam brush
- All pumps use stainless steel rotors
- Feature durable, dependable, three-bearing construction
- Available in either flange or clamp mount

- Buna-N or other elastomer seals available for added chemical resistance
- Special internal materials used to eliminate metal to metal contact allowing for long life and quiet operation

**PROCON®**  
Products

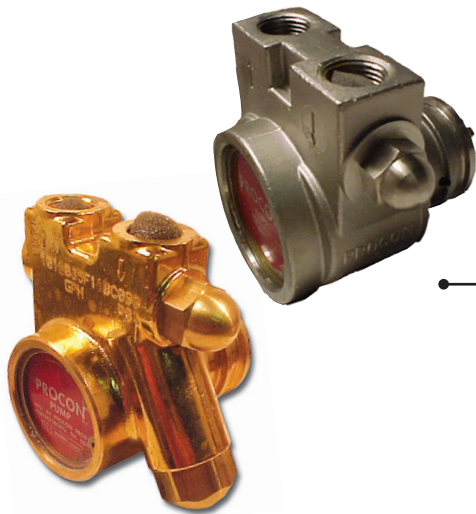

### CLAMP STYLE ROTARY VANE PUMPS

PROCON PRODUCTS

**PROCON®**  
Products

PRICE	PART #	PROCON #	MOUNT	PORT SIZE	BODY
<b>\$102.87</b>	<b>PPC01304XLV</b>	101A100R11BB	Clamp	3/8"	Brass
<b>\$84.21</b>	<b>PPC01504A</b>	102A100F11XX	Clamp	3/8"	Brass
<b>\$165.02</b>	<b>PPC01504R</b>	103A100F31RA	Clamp	3/8"	SS
<b>\$94.88</b>	<b>PPCB1304XH</b>	101B100F11BC060	Clamp	3/8"	Brass
<b>\$90.09</b>	<b>PPC01504XLV</b>	102A100R11BB	Clamp	3/8"	Brass
<b>\$170.43</b>	<b>PPC01604XLV</b>	103A100R31BB	Clamp	3/8"	SS
<b>\$150.17</b>	<b>PPCB2507X</b>	104B240F11BA	Clamp	1/2"	Brass
<b>\$166.65</b>	<b>PPCB2507XLV</b>	104B240R11BB	Clamp	1/2"	Brass
<b>\$275.81</b>	<b>PPCB2607X</b>	105B240F31BA	Clamp	1/2"	SS
<b>\$297.30</b>	<b>PPCB2607XLV</b>	105B240R31BB	Clamp	1/2"	SS
<b>\$161.01</b>	<b>PP2507EFX</b>	104E240G12BA200	Clamp	1/2"	Brass

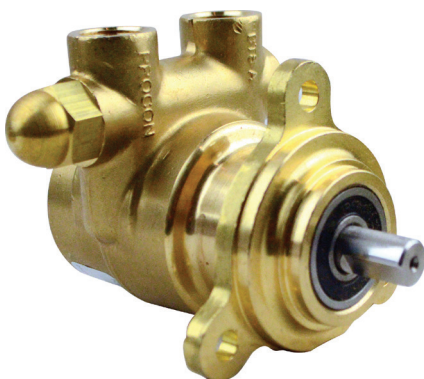

### FLANGE STYLE ROTARY VANE PUMPS

PROCON PRODUCTS

**PROCON®**  
Products

PRICE	MODEL	PROCON #	MOUNT	PORT SIZE	BODY
<b>\$100.71</b>	<b>PP1504XLV</b>	102E100R11BB	Flange	3/8"	Brass
<b>\$148.64</b>	<b>PP2507A</b>	104E240F11XX	Flange	1/2"	Brass
<b>\$153.41</b>	<b>PP2504XL</b>	104E165F11BB	Flange	1/2"	Brass
<b>\$153.39</b>	<b>PP2507X</b>	104E240F11BA	Flange	1/2"	Brass
<b>\$264.19</b>	<b>PP2607A</b>	105E240F31XX	Flange	1/2"	SS
<b>\$148.64</b>	<b>PP2508AF</b>	104E265F12XX	Flange	5/8"	Brass
<b>\$594.83</b>	<b>PP3608A</b>	106N480F11XX	Flange	1"	SS



### PUMP EXTRAS

PROCON PRODUCTS

**PROCON®**  
Products

PRICE	PART #	DESCRIPTION
<b>\$2.25</b>	<b>PPC1113</b>	Replacement V-Band Clamp
<b>\$30.30</b>	<b>PPC3045</b>	5/8" x 7/16" coupling
<b>\$82.18</b>	<b>PPC32061</b>	5/8" x 5/8" coupling
<b>\$64.87</b>	<b>PPA10481C</b>	Adapter for 56C
<b>\$94.75</b>	<b>PPA3207</b>	Adapter for 3600
<b>\$357.78</b>	<b>PPM012</b>	1/2 HP clamp style motor
<b>\$291.11</b>	<b>PPM013</b>	1/3 HP clamp style motor



## FLUID-O-TECH ROTARY VANE PUMPS

### ROTARY VANE PUMPS

#### FLUID-O-TECH PUMPS



- Excellent for tire cleaner, presoak, spot-free RO water, and foam brush
- All pumps use stainless steel rotors
- Feature durable, dependable, three-bearing construction
- Buna-N or other elastomer seals available for added chemical resistance
- Special internal materials used to eliminate metal-to-metal contact allowing for long life and quiet operation
- Available in either flange or clamp mount

#### TECHNICAL FEATURES AND MANUFACTURING CHARACTERISTICS:

- The rotary vane pumps are available in brass or stainless steel base material, with a stainless steel AISI 303 rotor, and carbon graphite internal parts.
- The inlet and outlet ports are 3/8", 1/2", or 1" NPT/GAS threaded.
- The pumps are designed to be directly mounted to the motor with a stainless steel clamp.
- Maximum operative temperature: 70 °C (158 °F).



FTPB401



FTP300



FTP0801AV



FTP801F



FTP0311V



FTP811A

### CLAMP STYLE

#### FLUID-O-TECH PUMPS

PRICE	PART #	DESCRIPTION
\$75.36	FTP300	Brass, 3/8", 1.7 GPM, Clamp Mount, No Relief
\$210.77	FTP811A	Stainless, 1/2", 4.3 GPM, Clamp Mount, Brass Key w/Relief
\$84.62	FTP0301V	Brass, 3/8", 1.7 GPM, Clamp, Viton, w/Relief
\$91.54	FTP0301XV	Brass, 3/8", 1.7 GPM, Clamp, Strainer, Viton, w/Relief
\$117.69	FTP0311V	Stainless, 3/8", 1.7 GPM, Clamp, Viton, w/Relief
\$133.85	FTP0801AV	Brass, 1/2", 4.3 GPM, Clamp, Key, Viton, w/Relief
\$214.62	FTP0811AV	Stainless, 1/2", 4.3 GPM, Clamp, Key, Viton, w/Relief
\$126.15	FTP1000	Brass, 1/2", 5.3 GPM, Clamp Mount, No Relief
\$94.62	FTPB401	Brass, 3/8", 2.4 GPM, Clamp Mount, w/Relief

### FLANGE STYLE

#### FLUID-O-TECH PUMPS

PRICE	PART #	DESCRIPTION
\$136.15	FTP800F	Brass, 1/2", 4.3 GPM, Flange Mount, No Relief
\$136.15	FTP801F	Brass, 1/2", 4.3 GPM, Flange Mount, w/Relief
\$215.38	FTP810F	Stainless, 1/2", 4.3 GPM, Flange Mount, No Relief
\$91.54	FTP0301FV	Brass, 3/8", 1.7 GPM, Flange, Viton, w/Relief
\$680.00	FTP0404	Stainless, 1", 7.7 GPM, Flange, No Relief



FTP0301V



FTP800F

### EXTRAS

#### FLUID-O-TECH PUMPS

PRICE	PART #	DESCRIPTION
\$25.60	FTP918111	Coupling for 56C to Clamp Mount
\$18.46	FTP928003	Adapter for 56C to Clamp Mount
\$3.24	FTP948001	Replacement V-Band Clamp



FTP0301XV



FTP0404

## FLOJET® PUMPS



### MODEL G57 DOUBLE DIAPHRAGM AIR DRIVEN TRANSFER PUMP

FLOJET PUMPS



- Constructed of corrosion-resistant materials to handle a variety of chemicals
- Double diaphragm air driven transfer pump
- FLOW: 7 GPM
- PRESSURE: 100 PSI
- MAX TEMP: 120° F
- Self-priming to 15'
- Patented shuttle valve eliminates stalling

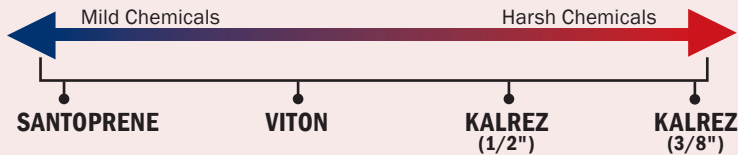

PRICE	PART #	FLOJET #	TYPE
\$102.17	FP7040	G575215D	Santoprene
\$142.99	FP7020	G573215D	Viton
\$201.37	FP57212	G57C212D	Kalrez (1/2")
\$201.37	FP57202	G57C202D	Kalrez (3/8")



### REPAIR KITS FOR G57 SERIES

FLOJET PUMPS

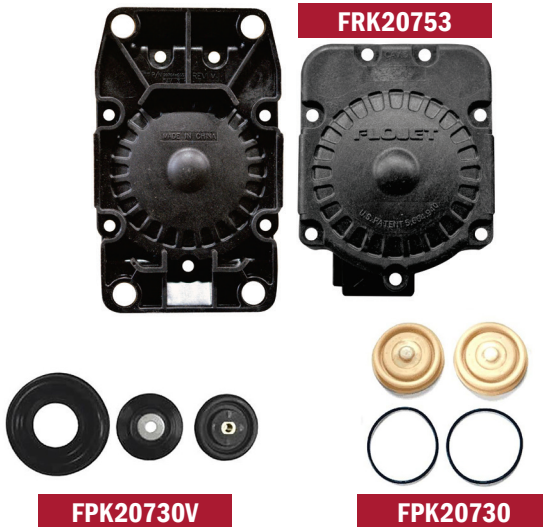

PRICE	PART #	FLOJET #	TYPE	QTY/KIT	PIECE #
<b>CHECK VALVE ASSEMBLY KIT</b>					
\$16.83	FPK207400	20740050A	Santoprene	4	1
\$61.74	FPK207400V	20740020A	Viton	4	1
\$67.56	FPK20740022	20740022A	Kalrez	4	1
<b>DIAPHRAGM KIT (INCLUDES PISTONS)</b>					
\$25.32	FPK20730	20730000A	Santoprene	2	2
\$46.95	FPK20730V	21000209	Viton	2	2
\$134.59	FPK21000661	21000661A	Kalrez	2	2
<b>FLANGE HOUSING KIT</b>					
\$46.69	FPK208960	20896000A	-	2	4
<b>HARDWARE KIT (INCLUDES: 14 SCREWS (#10X1.5" HI-LOW), SMALL RETAINER CLIP, LARGE RETAINER CLIPS, EXHAUST PORTS, EXHAUST MUFFLER)</b>					
\$21.40	FPK207931	20793100A	-	1	5
<b>SHAFT SIDE VALVE KIT</b>					
\$43.19	FPK20751	20751000A	Santoprene	1	3
\$42.85	FPK20751V	20751002A	Viton	1	3
<b>PORT KIT</b>					
\$18.57	FPK20381099	20381099	Viton Extreme	-	-
<b>END CAP KIT</b>					
\$41.10	FPK20753	20753000A	-	-	-

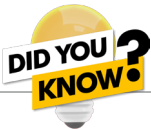

The car wash chemicals and soaps pumped through Flojet air-powered pumps often are corrosive and can shorten the life of a pump and pump components.

To combat this, Flojet pump components are made with tough DuPont elastomers that resist corrosion and help extend their life.

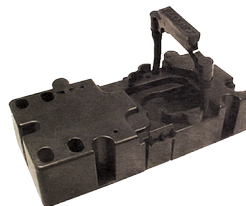

### MOUNTING BRACKET

FLOJET PUMPS



- Spring brackets snap together easily - installation is a breeze!
- Ideal for mounting on rack or wall

**\$14.62** FPK209821

### POLYTUBE & BARB FITTINGS FOR MODEL G57 SERIES

FLOJET PUMPS



\$5.91	FPK06V	3/8" Barb Viton	\$13.60	FPK04PT	1/4" Polytube Fitting
\$4.11	FPK08B	1/2" Barb	\$4.11	FPK06B	3/8" Barb Kit
\$6.07	FPK08B90	90° 1/2" Barb	\$4.11	FPK06B90	90° 3/8" Barb
\$6.33	FPK08MPE	1/2" Male Pipe End	\$6.33	FPK06MPE	3/8" Male Pipe End
\$5.99	FPK08MPE90	90° 1/2" Male Pipe	\$5.99	FPK06MPE90	90° 3/8" Male Pipe
\$24.38	FPK08PT	1/2" Polytube Fitting	\$4.11	FPK06B	3/8" Conversion Kit

**CALIFORNIA PROPOSITION 65 NOTE:** some items on this page may fall under the Proposition 65 act. Please consult the State of California Proposition 65 list ([oehha.ca.gov/proposition-65/proposition-65-list](http://oehha.ca.gov/proposition-65/proposition-65-list)) to learn more and to see a comprehensive list of Proposition 65 chemicals.



## FLOJET® PUMPS

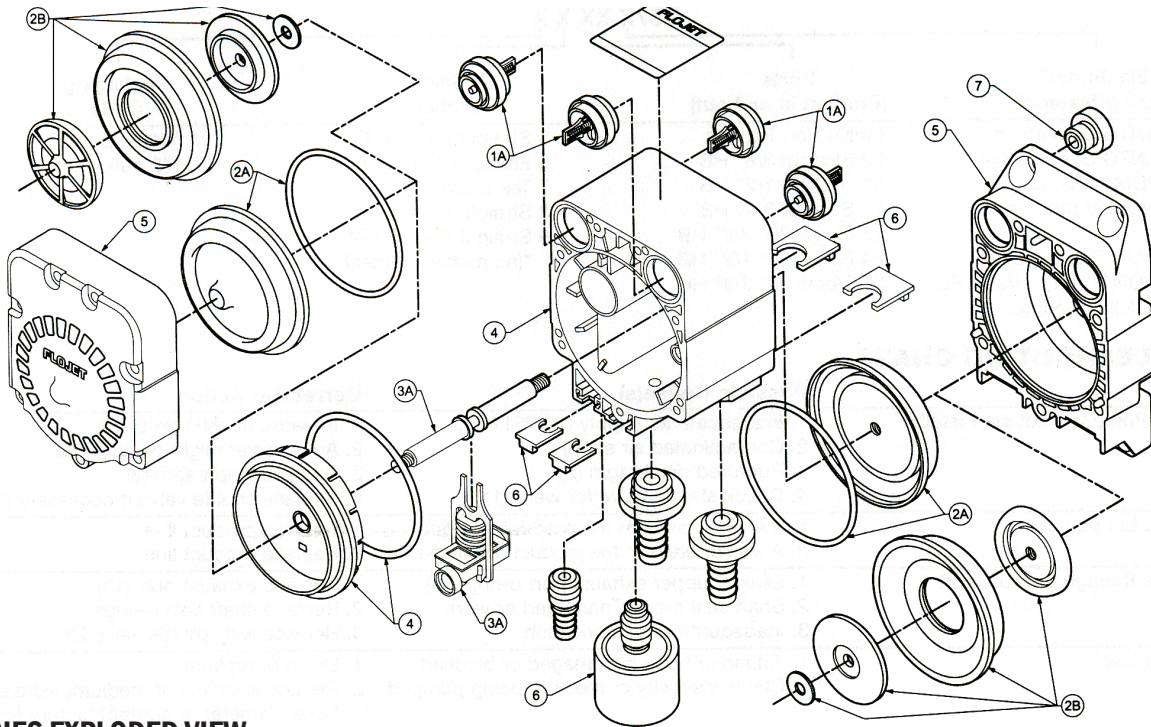

### MODEL G57 SERIES EXPLODED VIEW FLOJET PUMPS

**FLOJET**

1A	<b>FPK207400</b>	Check Valve Assembly - Santoprene
1B	<b>FPK207400V</b>	Check Valve Assembly - Viton
2A	<b>FPK20730</b>	Diaphragm Kit - Santoprene
2B	<b>FPK20730V</b>	Diaphragm Kit - Viton
3A	<b>FPK20751</b>	Shaft & Slide Valve Assembly - Santoprene

3B	<b>FPK20751V</b>	Shaft & Slide Valve Assembly - Viton
4	<b>FPK208960</b>	Flange & Housing Assembly with O-Ring
5	<b>FPK20753</b>	End Caps
6	<b>FPK207931</b>	Hardware Kit

## FLOJET LOW PRESSURE PUMPS



### MODEL 5100 FLOJET LOW PRESSURE PUMPS

**FLOJET**

- **FLOW:** 2.5 GPM
- **MAX PSI:** 80
- **MAX TEMP:** 120 °F
- **LIQUID INLET/OUTLET:** 3/8" barb
- **AIR INLET/OUTLET:** 1/4" barb
- **SEALS:** See Chart
- Compact design with plug-in hose connections
- Pressure relief or bypass plumbing necessary
- Air operated double diaphragm

PRICE	PART #	FLOJET #	TYPE
<del>\$89.74</del>	<b>FP51040</b>	N5100040B	Santoprene®
<del>\$114.11</del>	<b>FP51020</b>	N5100020B	Viton® Elastomer
<del>\$3.89</del>	<b>FPK01510</b>	1/4" Brass Air Inlet Fitting	



### DUAL AIR PUMPS FLOJET LOW PRESSURE PUMPS

**FLOJET**

- **FLOW:** 10.0 GPM
- **MAX PSI:** 100
- **MAX TEMP:** 120 °F
- **LIQUID INLET/OUTLET:** 1/2" FNPT
- **AIR INLET/OUTLET:** 1/4" barb
- **HOUSING:** Polypropylene
- Compact design with plug-in hose connections
- Pressure relief or bypass plumbing necessary
- Air operated double diaphragm

PRICE	PART #	FLOJET #	TYPE
<del>\$243.23</del>	<b>FP257501</b>	G257501A	Santoprene
<del>\$300.34</del>	<b>FP257301</b>	G257301A	Viton



**CALIFORNIA PROPOSITION 65 NOTE:** some items on this page may fall under the Proposition 65 act. Please consult the State of California Proposition 65 list ([oehha.ca.gov/proposition-65/proposition-65-list](http://oehha.ca.gov/proposition-65/proposition-65-list)) to learn more and to see a comprehensive list of Proposition 65 chemicals.



## FLOJET ELECTRIC DIAPHRAGM PUMPS



### FP04300042

FLOJET ELECTRIC DIAPHRAGM PUMPS



- **FLOW:** 3.4 GPM
- **VOLTAGE:** 115V
- **DIAPHRAGM:** Santoprene
- **BODY:** Polypropylene
- **MAX PSI:** 45
- **PORTS:** 1/2" barb
- **CHECK VALVE:** EPDM

**\$159.20** FP04300042  
Flojet #04300042A



### FP04300043

FLOJET ELECTRIC DIAPHRAGM PUMPS



- **FLOW:** 5.0 GPM
- **VOLTAGE:** 115V
- **DIAPHRAGM:** Santoprene
- **BODY:** Polypropylene
- **MAX PSI:** 45
- **PORTS:** 3/4" barb
- **CHECK VALVE:** EPDM

**\$159.20** FP04300043  
Flojet #04300043A



### FP04300043 & FP04300042 KITS

FLOJET ELECTRIC DIAPHRAGM PUMPS



PRICE	PART #	FLOJET #	DESCRIPTION
<b>\$69.28</b>	<b>FPK20404018</b>	20404018	Upper Housing Kit
<b>\$29.94</b>	<b>FPK20407030</b>	20407030	Check Valve Kit
<b>\$19.16</b>	<b>FPK20403040</b>	20403040	Diaphragm Kit
<b>\$52.17</b>	<b>FPK20115210</b>	20115210	Brush Endbell Kit
<b>\$38.78</b>	<b>FPK20400002</b>	20400002	<b>CAM KIT FOR FP04300042</b>
<b>\$49.61</b>	<b>FPK20400003</b>	20400003	<b>CAM KIT FOR FP04300043</b>



### FP04100143

FLOJET ELECTRIC DIAPHRAGM PUMPS



- **FLOW:** 5.0 GPM
- **PORTS:** 3/4"
- **BODY:** Polypropylene
- **MAX PSI:** 25
- **DIAPHRAGM:** Santoprene
- **VOLTAGE:** 12VC Demand
- **CHECK VALVE:** EPDM

**\$138.03** FP04100143 Flojet #04100143



### FP04100143 KITS

FLOJET ELECTRIC DIAPHRAGM PUMPS



PRICE	PART #	FLOJET #	DESCRIPTION
<b>\$43.62</b>	<b>FPK20404011</b>	20404011	Upper Housing Kit
<b>\$29.94</b>	<b>FPK20407030</b>	20407030	Check Valve Kit
<b>\$49.61</b>	<b>FPK20400003</b>	20400003	Cam Bearing Kit
<b>\$132.58</b>	<b>FPM02009037</b>	02009037A	Motor - 12V TEFC Standard Shaft



### FP04300504

FLOJET ELECTRIC DIAPHRAGM PUMPS



- **FLOW:** 5.0 GPM
- **VOLTAGE:** 12V
- **DIAPHRAGM:** Santoprene
- **BODY:** Polypropylene
- **MAX PSI:** 45
- **PORTS:** 3/4" barb
- **CHECK VALVE:** Viton

**\$174.10** FP04300504  
Flojet #04300504A



### "QUAD" DEMAND PUMPS

FLOJET ELECTRIC DIAPHRAGM PUMPS



- **FLOW:** 3.5 GPM
- **VOLTAGE:** 12V
- **DIAPHRAGM:** Santoprene
- **BODY:** Polypropylene
- **MAX PSI:** 45
- **PORTS:** 1/2"
- **CHECK VALVE:** Viton

**\$174.10** FP04300500  
Flojet #04300500A



### FP04300504 KITS

FLOJET ELECTRIC DIAPHRAGM PUMPS



PRICE	PART #	FLOJET #	DESCRIPTION
<b>\$78.69</b>	<b>FPK20404017</b>	20404017	Upper Housing Kit
<b>\$39.21</b>	<b>FPK20407020</b>	20407020	Check Valve Kit
<b>\$19.16</b>	<b>FPK20403040</b>	20403040	Diaphragm Kit
<b>\$49.61</b>	<b>FPK20400003</b>	20400003	<b>CAM BEARING KIT FOR FP04300504</b>
<b>\$38.78</b>	<b>FPK20400002</b>	20400002	<b>CAM BEARING KIT FOR FP04300500</b>
<b>\$132.58</b>	<b>FPM02009037</b>	02009037A	Motor - 12V TEFC Standard Shaft

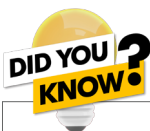

Established in 1975 as a manufacturer of special application pumps with an initial focus on the emerging cleaning machine market, XYLEM FLOJET has blossomed into a leading global supplier of small pumps, motors and dispensing pumps for a variety of industries.

**CALIFORNIA PROPOSITION 65 NOTE:** some items on this page may fall under the Proposition 65 act. Please consult the State of California Proposition 65 list ([oehha.ca.gov/proposition-65/proposition-65-list](http://oehha.ca.gov/proposition-65/proposition-65-list)) to learn more and to see a comprehensive list of Proposition 65 chemicals.

# PUMPS

## FLOJET ELECTRIC DIAPHRAGM PUMPS



### FP02130032

FLOJET ELECTRIC DIAPHRAGM PUMPS



- **FLOW:** 2.0 GPM
- **MAX PSI:** 95
- **VOLTAGE:** 115V
- **BODY:** Nylon
- **DIAPHRAGM:** EPDM
- **CHECK VALVE:** EPDM

<b>\$210.24</b>	<b>FP02130032</b>
Flojet #02130032A	



### FP02130232

FLOJET ELECTRIC DIAPHRAGM PUMPS



- **FLOW:** 1.8 GPM
- **MAX PSI:** 95
- **VOLTAGE:** 230V
- **BODY:** Nylon
- **DIAPHRAGM:** EPDM
- **CHECK VALVE:** EPDM

<b>\$220.23</b>	<b>FP02130232</b>
Flojet #02130232A	



### FP02130032 & FP02130232 KITS

FLOJET ELECTRIC DIAPHRAGM PUMPS



PRICE	PART #	DESCRIPTION	FLOJET #
<b>\$11.46</b>	<b>FPP11028101</b>	Baseplate Assembly, Plastic. Includes grommets and screws	11028101
<b>\$60.73</b>	<b>FPK20316003A</b>	Upper Housing/Switch Assmblly	20316003
<b>\$39.77</b>	<b>FPK21140007</b>	Pump Service Kit (Nylon)	21140007



### DUPLEX SERIES PUMP

FLOJET ELECTRIC DIAPHRAGM PUMPS



- **FLOW:** 1.6 GPM
- **MAX PRESSURE:** 60 PSI
- **VOLTAGE:** 115V DEMAND W/ Bypass

<b>\$122.88</b>	<b>FP1631H5011</b>	Flojet# D1631H5011A
-----------------	--------------------	---------------------



### DUPLEX SERIES KITS

PRICE	PART #	DESCRIPTION	FLOJET #
<b>\$43.62</b>	<b>FPP02090100</b>	Pressure Switch	02090100
<b>\$16.76</b>	<b>FPK20914003</b>	EPDM Check Valve Kit	20914003A
<b>\$60.73</b>	<b>FPK21022042</b>	Cam Bearing/Diaphragm Kit	21022042A
<b>\$136.85</b>	<b>FPM02029000</b>	Motor Assembly - 115V	02029000A
<b>\$52.17</b>	<b>FPK20115210</b>	End Bell Brush Kit	20115210



### TRIPLEX SERIES PUMP

FLOJET ELECTRIC DIAPHRAGM PUMPS



- **FLOW:** 2.0 GPM
- **MAX PSI:** 60 PSI
- **LIQUID TEMP:** 40° F - 140° F
- **INLET:** 3/8" NPTF
- **OUTLET:** 3/8" NPTF

<b>\$129.32</b>	<b>FP03501503</b>	Flojet# 03501503A
-----------------	-------------------	-------------------



### TRIPLEX SERIES KITS

PRICE	PART #	DESCRIPTION	FLOJET #
<b>\$47.90</b>	<b>FPK02091060</b>	Pressure Switch	02091060
<b>\$38.49</b>	<b>FPK20407033</b>	Check Valve Kit	20407033

## VARIOUS PUMP MODELS & KITS

(ALL PUMP MODELS & KITS AVAILABLE!)

FLOJET ELECTRIC DIAPHRAGM PUMPS



- Great choice for tire cleaner, presoak, carpet cleaning and extraction applications. All pumps can be run dry without damage and have superior self-priming capabilities. Rated to 160° F.

#### AVAILABLE IN TWO STYLES:

- **BYPASS:** Pump continues to run and internally bypass if discharge is partially or fully closed.
- **DEMAND:** Pressure switch automatically starts and stops pumps at specific pressure settings

PRICE	PART #	FLOJET #	GPM	VOLTS	PSI	CONTROL	CONNECTION	
<b>\$163.49</b>	<b>FP02100032</b>	02100032A	1.6	115	60	DEMAND	Hard wire	
<b>\$188.87</b>	<b>FP02100022</b> With Viton seal	02100022A	1.6	115	60	DEMAND	Hard wire	
<b>\$306.97</b>	<b>FP304010110</b> With Viton seal	1304010110	3.5	115	45	DEMAND	6' Cord	
<b>\$213.48</b>	<b>FP02100689</b>	02100689A	2.0	230	55	BYPASS	Hard wire	
<b>\$55.10</b>	<b>FP508224</b>	ET508224A	0.4	115	55	ON/OFF	Hard wire	
<b>\$184.34</b>	<b>FP04300545</b>	04300545A	3.5	115	45	DEMAND	6' Cord	
<b>\$197.54</b>	<b>FP3635E7011</b>	D3635E7011A	2.0	115	100	DEMAND	Hard wire	
<b>\$178.65</b>	<b>FP3835H1411</b>	D3835H1411A	2.0	115	70	BYPASS	6' Cord	

**CALIFORNIA PROPOSITION 65 NOTE:** some items on this page may fall under the Proposition 65 act. Please consult the State of California Proposition 65 list ([oehha.ca.gov/proposition-65/proposition-65-list](http://oehha.ca.gov/proposition-65/proposition-65-list)) to learn more and to see a comprehensive list of Proposition 65 chemicals.

## PENTAIR STA-RITE BOOSTER & CENTRIFUGAL PUMPS



### BOOSTER PUMPS



The HP/HPS Booster Pumps are the most durable booster pump available. The patented SignalSeal™ floating impeller design minimizes thrust loads allowing for continuous operation without damage to motor bearings, mechanical seal or pump hydraulic components.

- **MAX. INLET PRESSURE:** 80 PSI • **MAX. SUCTION LIFT:** 15 ft.
- **MAX. WORKING PRESSURE:** 315 PSI • **MAX. TEMP.:** 140° F

PRICE	PART#	MATERIAL	MOTOR	GPM	PSI	PORT SIZE DISCHARGE/SUCTION
\$1,032.07	HP10D	Cast Iron	3/4HP - 1 Phase	10 GPM	100 PSI	3/4" / 3/4"
\$1,167.17	HP10E		1 HP - 1 Phase	10 GPM	135 PSI	3/4" / 3/4"
\$1,253.05	HP10E3		1 HP - 3 Phase	10 GPM	135 PSI	3/4" - 3/4"
\$1,503.40	HP10G		2 HP - 1 Phase	10 GPM	195 PSI	3/4" / 3/4"
\$1,260.37	HP10G3		2 HP - 3 Phase	10 GPM	195 PSI	3/4" / 3/4"
\$1,386.59	HP20G		2 HP - 1 Phase	15 GPM	145 PSI	1" / 1"
\$1,187.45	HP20G3		2 HP - 3 Phase	15 GPM	145 PSI	1" / 1"
\$2,111.91	HP20H		3 HP - 1 Phase	20 GPM	195 PSI	1" / 1"
\$1,915.53	HP20H3		3 HP - 3 Phase	20 GPM	195 PSI	1" / 1"
\$2,054.97	HP30H		3 HP - 1 Phase	30 GPM	125 PIS	1 1/4" / 1 1/4"
\$1,979.22	HP30H3	3 HP - 3 Phase	30 GPM	125 PSI	1 1/4" / 1 1/4"	
\$1,176.80	HP7E	Stainless Steel	1 HP - 1 Phase	6 GPM	195 PSI	3/4" / 3/4"
\$1,631.28	HPS10G3		2 HP - 3 Phase	10 GPM	195 PSI	3/4" / 3/4"
\$1,565.99	HPS20G3		2 HP - 3 Phase	15 GPM	145 PSI	1" / 1"
\$2,352.63	HPS20H		3 HP - 1 Phase	20 GPM	315 PSI	1" / 1"
\$2,624.54	HPS20H3		3 HP - 3 Phase	20 GPM	155 PSI	1" / 1"
\$2,409.13	HPS30H		3 HP - 1 Phase	30 GPM	125 PSI	1 1/4" / 1 1/4"
\$2,528.80	HPS30H3		3 HP - 3 Phase	30 GPM	125 PSI	1 1/4" / 1 1/4"
\$1,489.75	HPS7E		1 HP - 1 Phase	6 GPM	195 PSI	3/4" / 3/4"
\$1,714.80	HPS10F		1 1/2 HP - 1 Phase	10 GPM	175 PSI	3/4" / 3/4"
\$1,735.08	HPS10F3		1 1/2 HP - 3 Phase	10 GPM	175 PSI	3/4" / 3/4"
\$1,462.94	HPS10E0	1 HP - 1 Phase	10 GPM	134 PSI	3/4" / 3/4"	



### J & JB SERIES HIGH HEAD CENTRIFUGAL PUMP



- Drain port provides for easy winterizing
- Delivers up to 140' of head, with flow rates up to 90 GPM
- Replaceable wear ring and simple back pull-out design provide easy serviceability
- Silicon bronze impellers and shaft seals (in JB series) allow use with water up to 225° F

PRICE	PART #	MOTOR	DESCRIPTION
\$1,354.87	JHG3-52HMS7	2 HP - 3 Phase	Vertical Discharge, seal flush line, Shaft Seal - Viton w/silicon carbide face
\$889.25	JHG3-52HMS10	2 HP - 3 Phase	Horizontal discharge, seal flush line, Standard Shaft Seal w/carbon ceramic faces

## PENTAIR STA-RITE JET PUMPS

PLASTIC



CAST IRON



STAINLESS STEEL



### JET PUMPS



- Pentair Sta-Rite Jet pumps are an ideal choice for water booster systems in car washes, farms, home, etc. Designed for use in shallow well pumping systems (to 25' lift) or in foam brush, presoak and tire cleaner applications. All pumps come standard with adjustable pressure switches with shut-off pressures to 70 PSI (no pressure switch on CJ models). Available with cast iron, stainless or plastic bodies.
- **MAX. TEMPERATURE LIMITS:** 122° F (50° C)
  - **MAX. INLET PRESSURE:** 50 PSI
  - **AVG. PRIMING TIME AT 20 FEET:** CJ90E = 5.3 min. CJ90F = 4.2 min.

PRICE	PART #	MAX FLOW	SHUT-OFF PSI	BODY	1-PHASE MOTORS	PORT SIZE DISCHARGE/SUCTION
\$590.09	HNC	15.0 GPM	70	Cast Iron	1/2 HP 115/230 V	1" / 1 1/4"
\$749.32	HND	21.4 GPM	64	Cast Iron	3/4 HP 115/230 V	1" / 1 1/4"
\$831.83	HNE	28.5 GPM	67	Cast Iron	1 HP 115/230 V	1" / 1 1/4"
\$544.90	PNC	8.6 GPM	77	Plastic	1/2 HP 115/230 V	1" / 1 1/4"
\$561.64	PND	12.8 GPM	77	Plastic	3/4 HP 115/230 V	1" / 1 1/4"
\$611.80	PNE	18.0 GPM	67	Plastic	1 HP 115/230 V	1" / 1 1/4"
\$602.17	PWP-MS1	10.3 GPM	-	Plastic	1/2 HP 115/230 V	1" / 1 1/4"
\$819.32	CJ90F	14.1 GPM	80	Stainless	1 1/2 HP 115/230 V	1" / 1 1/4"
\$828.19	CJ90E	14.1 GPM	63	Stainless	1 HP 115/230 V	1" / 1 1/4"

ALL PENTAIR BRANDS ARE TRADEMARKS OF PENTAIR



## PENTAIR STA-RITE PUMPS



### RECLAIM PUMPS PENTAIR STA-RITE PUMPS



- Drain port provided for easy winterizing
- Normal wear parts are easily accessible for service and replacement without disturbing piping or mounting
- Heavy-duty motors are designed for continuous operation

PRICE	PART #	DESCRIPTION
<b>\$855.96</b>	<b>DHE350</b>	Reclaim Pump 1HP/3PH - 1½" Port
<b>\$1,327.37</b>	<b>DHG352</b>	Reclaim Pump 2HP/3PH - 2" Port
<b>\$1,986.95</b>	<b>DHH316</b>	Reclaim Pump 3HP/3PH - 2" Port
<b>\$2,063.19</b>	<b>DHJ3</b>	Reclaim Pump 230/460 3PH 5HP - 2" Port
<b>\$297.35</b>	<b>PKG51</b>	6" Trap with Basket - 2" FPT - 1 & 2 HP - 1½" Port
<b>\$210.77</b>	<b>PKG53</b>	2" Inlet Flange with Flapper - 1 & 2 HP - 2" Port
<b>\$236.11</b>	<b>PKG73</b>	3" Inlet Flange with Flapper - 3 & 5 HP - 3" Port
<b>\$830.78</b>	<b>PKG98</b>	8" Trap with Basket - 3" FPT - 3 & 5 HP - 3" Port



### SUBMERSIBLE PUMPS PENTAIR STA-RITE PUMPS



- Reduced amp draw
- Cooler and quieter operation
- **IMPELLERS** - Precision molded for perfect balance... ultra smooth for the highest performance and efficiency. Allows for .080" solids.
- **SHAFT** - Positive drive, hexagonal 7/16" - 300-grade stainless steel shaft offers generous impeller drive surfaces.
- **SHAFT BEARING** - Exclusive self-lubricating Nylatron® bearing resists wear surface from sand and abrasives.
- **SHELL** - Heavy-walled, corrosion-resistant 300-grade stainless steel.

PRICE	PART #	GPM	PSI	VOLTAGE	PORT	PRICE	PART #	GPM	PSI	VOLTAGE	PORT
<b>\$504.71</b>	<b>20DM5121</b>	14	50	1/2HP 115V	1¼"	<b>\$533.63</b>	<b>30DM5121</b>	30	25	1/2HP 115V	1½"
<b>\$504.71</b>	<b>20DM5221</b>	14	50	1/2HP 230V	1¼"	<b>\$533.63</b>	<b>30DM5221</b>	30	25	1/2HP 230V	1½"

ALL PENTAIR BRANDS ARE TRADEMARKS OF PENTAIR

## BOOSTER PUMPS



### MULTI-STAGE BOOSTER PUMPS FLINT & WALLING PUMPS



PRICE	PART #	DESCRIPTION
<b>\$806.40</b>	<b>FWPB1014S101</b>	Multi-stage booster pump with a stainless steel shell Cast iron suction & discharge   14 stage, 1HP, 1PH, 115/230v, 185PSI
<b>\$654.96</b>	<b>FWPB1016A151</b>	Multi-stage booster pump with a stainless steel shell 16 stage, 1½HP, 1PH, 115/230v, 211PSI
<b>\$1,038.33</b>	<b>FWPB1914A203</b>	Multi-stage booster pump with a cast iron housing 2HP, 3PH 208-230/460v, 190 PSI

### MULTI-STAGE BOOSTER PUMP DAYTON PUMPS



- Includes o-ring casing seal: High-pressure sealing with simple disassembly for easy maintenance and repair.
- Highly-resistant diffusers: Glass-filled with fixed impeller design
- 300 stainless steel rabbit lock bowls, no gaskets required
- 13-stage
- Continuous duty
- Dimensions: 29½" L x 6¾" W x 8¾" H
- Ball-bearing
- 56J Frame

<b>\$617.25</b>	<b>45MW74</b>	1 Phase, 115/230 Voltage
<b>\$898.33</b>	<b>45MW90</b>	3 Phase, 208-230/460 Voltage



## GOULDS PUMPS



### GB SERIES - MULTI-STAGE BOOSTER PUMPS GOULDS PUMPS

- Multi-stage design provides steady, quiet, vibration free operation.
- Standard cast iron for general service or stainless steel for filtration applications.
- Reliable high-pressure sealing with easy disassembly for maintenance or repair.
- Motors are designed for continuous operation.
- Impellers and diffusers are glass filled composite material with fixed impeller design.
- High resistance to corrosion and abrasion.
- Bowls: 300 stainless steel rabbit lock for positive alignment with no gaskets required.
- Maximum suction inlet pressure: 75 PSI

### GB SERIES GOULDS PUMPS



PRICE	PART #	MOTOR	MATERIAL	FLOW
\$989.12	GL7GBC1014R0	1HP - 1 Phase	Cast Iron/Buna-N Seals	7 GPM
\$1,250.15	GL7GBS1014R4	1HP - 1 Phase	Stainless Steel/Viton Seals	7 GPM
\$1,472.17	GL7GBS1517R4	1½HP - 3 Phase	Stainless Steel/ Viton Seals	7 GPM
\$1,049.62	GL10GBC1514Q0	1½HP - 1 Phase	Cast Iron/Buna-N Seals	10 GPM
\$1,256.65	GL10GBC2017S0	2HP - 3 Phase	Cast Iron/Buna-N Seals	10 GPM
\$1,312.16	GL10GBS1514Q4	1½HP - 1 Phase	Stainless Steel/Viton Seals	10 GPM
\$1,441.67	GL10GBS2014S4	2HP - 1 Phase	Stainless Steel/Viton Seals	10 GPM
\$1,517.18	GL10GBS2017S4	2HP - 3 Phase	Stainless Steel/Viton Seals	10 GPM
\$1,126.63	GL18GBC2014N0	2HP - 1 Phase	Cast Iron/Buna-N Seals	18 GPM
\$1,234.15	GL18GBC2017N0	2HP - 3 Phase	Cast Iron/Buna-N Seals	18 GPM
\$1,473.67	GL18GBC3014Q0	3HP - 1 Phase	Cast Iron/Buna-N Seals	18 GPM
\$1,657.19	GL18GBC3017Q0	3HP - 3 Phase	Cast Iron/Buna-N Seals	18 GPM
\$1,387.16	GL18GBS2014N4	2HP - 1 Phase	Stainless Steel/Viton Seals	18 GPM
\$1,732.70	GL18GBS3014Q4	3HP - 1 Phase	Stainless Steel/Viton Seals	18 GPM

### NPE SERIES - 1" x 1¼" GOULDS PUMPS



PRICE	PART #	MOTOR	GPM	PSI	MAX GRAVITY
\$847.60	GL1ST1C4E4	½HP - 1 Phase	12	30	1.0
\$847.60	GL1ST1C4F4	½HP - 1 Phase	28	15	1.0
\$838.10	GL1ST1D1D2	¾HP - 1 Phase	17	36	1.0
\$814.60	GL1ST1D1D4	1 Phase Open Drip Proof Motor	Call for Info	Call for Info	1.0
\$1,002.12	GL1ST1F1B4	1½HP - 1 Phase	Call for Info	Call for Info	Call for Info
\$1,061.12	GL1ST1F4C4	1½HP - 1 Phase	20	45	1.0
\$931.61	GL1ST1E4D4	1HP - 1 Phase	30	30	1.0
\$1,176.63	GL1ST1G4A4	2HP - 1 Phase	30	56	1.0
\$1,176.63	GL1ST1G4B4	2HP - 1 Phase	50	30	1.0
\$1,580.68	GL1ST1H9B4	3HP - 3 Phase	50	30	1.4
* \$1,104.13	GL1ST1G9B4	2HP - 3 Phase	50	30	Call for Info

### NPE SERIES - 2 ST - 1½" x 1¼" GOULDS PUMPS



PRICE	PART #	MOTOR	GPM	PSI	MAX GRAVITY	INLET x OUT
* \$887.61	GL2ST1E1J4	1HP - 1 Phase Open Drip Proof Motor	40	25	Call for Info	1½" x 1¼"
* \$1,582.18	GL2ST4H9B4	3HP - 3 Phase	45	40	Call for Info	
* \$1,582.18	GL2ST1H4D4	3HP - 1 Phase	50	45	1.0	
* \$1,021.62	GL2ST1F1H4	1½HP - 1 Phase	60	25	Call for Info	
* \$1,113.98	GL2ST1F4H4	1½HP - 1 Phase	70	20	1.0	
* \$1,193.13	GL2ST1G4G4	2HP - 1 Phase	70	30	1.0	
* \$1,582.18	GL2ST1H9G4	3HP - 3 Phase	70	30	1.4	
* \$1,586.68	GL2ST1J1C4	5HP - 1 Phase	70	52	1.0	
* \$1,661.25	GL2ST1H9D4	3HP - 3 Phase	80	40	Call for Info	

### NPE SERIES - 3 ST - 1½" X 2" GOULDS PUMPS



PRICE	PART #	MOTOR	GPM	PSI	MAX GRAVITY	INLET x OUT
* \$2,077.24	GL3ST1J9D4	5HP - 3 Phase	125	25	1.5	2" x 1½"
* \$1,593.18	GL3ST1H9E4	3HP - 3 Phase	110	25	Call for Info	

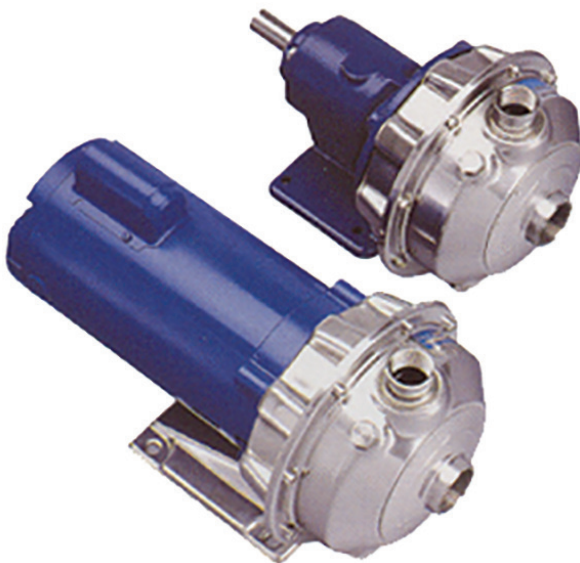

### NPE SERIES - CENTRIFUGAL PUMPS GOULDS PUMPS

- Complete AISI 316L stainless steel liquid handling components and mounting bracket for corrosion resistance, appearance, and improved strength.
- Enclosed impeller with unique floating seal ring design maintains efficiency for the life of the pump without adjustments.
- Stainless steel construction with NPT threads, center line connections, accessible vent, prime and drain connections with SS plugs.
- Rugged ball bearing design for continuous reliable duty under all operating conditions.

### NPE SERIES - SEAL KIT GOULDS PUMPS

\$120.78 GLKNPE

\* INDICATES THIS PUMP IS HIGH EFFICIENCY!

## BERKELEY PUMPS



### SSCX SERIES CENTRIFUGAL PUMPS

BERKELEY PUMPS

- **STAINLESS-STEEL HOUSING AND SHAFT** – Maximum corrosion resistance in chemical as well as water applications; smooth flow path assures quiet operation.
- **HIGH-TEMPERATURE RATING** – The SSCX Series centrifugal pump (with 304 SS Impeller) is designed for temperatures to 250 °F, making it an ideal choice for a wide range of pump applications and varying temperature conditions. The Noryl® impeller is rated to a maximum operating temperature of 185 °F.
- **MECHANICAL SHAFT SEALS** – Choice of seal options to meet your application needs. All are precision lapped and highly polished for long life and reliability.
- **IMPELLER OPTIONS** – 304 Stainless Steel or precision-molded Noryl® feature ultra-smooth flow ports to maximize performance and efficiency.
- **DRAIN/VENT PORTS** – Priming and draining is easier, faster.

ALSO AVAILABLE IN 3 PHASE

### DID YOU KNOW...

High-head performance and quiet operation join corrosion-resistant dependability with Berkeley SSCX Series centrifugal pumps.

PRICE	KR PART #	DESCRIPTION
<b>\$831.35</b>	<b>B82411</b>	Berkeley Centrifugal Pumps 3/4 HP Single Phase
<b>\$1,006.02</b>	<b>B82493</b>	Berkeley Centrifugal Pumps 1 HP Single Phase 50 PSI
<b>\$1,158.00</b>	<b>B82421</b>	Berkeley Centrifugal Pumps 1½ HP Single Phase

## ARO DIAPHRAGM PUMPS



### GRIME FIGHTER PUMP

ARO DIAPHRAGM PUMPS



- **AIR INLET:** 1/4" NPTF
- **FLUID INLET:** 1/2" NPTF
- **FLUID OUTLET:** 1/2" NPTF
- **MAX PRESSURE:** 100 PSI
- **WEIGHT:** 7.2 LBS
- **RATIO:** 1:1
- **MAX FLOW:** 7 GPM
- **MATERIALS:** Virgin PTFE, polypropylene & Santoprene

**\$415.43** APJGF

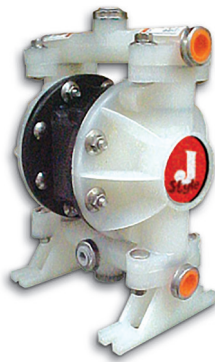

### ARO J-STYLE PUMP

ARO DIAPHRAGM PUMPS



- **AIR INLET:** 1/4" NPTF
- **FLUID INLET:** 1/2" NPTF
- **FLUID OUTLET:** 1/2" NPTF
- **MAX PRESSURE:** 100 PSI
- **MAX FLOW:** 13 GPM
- **MATERIALS:** Polypropylene

PRICE	PART #	MFG PART #
<b>\$820.80</b>	<b>APJ388</b>	66605J-388
<b>\$792.00</b>	<b>APJ3EB</b>	66605J-3EB
<b>\$973.80</b>	<b>APJ344</b>	66605J-344



### 1/4" COMPACT DIAPHRAGM PUMP

ARO DIAPHRAGM PUMPS

- Versatile OEM fluid dosing, from cleaners to chemicals to paint
- **INLET:** 1/4"
- **OUTLET:** 1/4"
- **MAX PRESSURE:** 125 PSI
- **MAX FLOW:** 5.3 GPM
- **MAX TEMP:** 175° F
- **MATERIALS:** Varies

PRICE	PART #	MATERIAL
<b>\$381.60</b>	<b>APM01</b>	Santoprene
<b>\$507.60</b>	<b>APM01T</b>	Teflon



### 1/2" DIAPHRAGM PUMP

ARO DIAPHRAGM PUMPS



- Ease of service through modular design
- Simul-Shift™ valve provides ultra-positive, reliable shift signal
- ARO's patented "Unbalanced" air valve ensures no-stall operation
- Center, end, and dual inlet/outlet manifold configurations for your application needs
- Bolted construction for leak-free fluid handling
- **INLET:** 1/2"
- **OUTLET:** 1/2"
- **MAX PRESSURE:** 100 PSI
- **MAX FLOW:** 13 GPM
- **MAX TEMP:** 150° F
- **MATERIALS:** Varies

PRICE	PART #	DIAPHRAGM MATERIAL
<b>\$807.30</b>	<b>AP388</b>	Urethane (for Soap)
<b>\$778.50</b>	<b>AP3EB</b>	Santoprene (for Soap)
<b>\$958.50</b>	<b>AP344</b>	Teflon (for tire/engine cleaner)

### 1/2" DIAPHRAGM PUMP KITS

ARO DIAPHRAGM PUMPS

PRICE	PART #	GPM
<b>\$113.78</b>	<b>APK141</b>	AIR SERVICE KIT
<b>\$165.56</b>	<b>APK88</b>	DIAPHRAGM KIT 388
<b>\$134.44</b>	<b>APKEB</b>	DIAPHRAGM KIT 3EB
<b>\$547.78</b>	<b>APK33</b>	DIAPHRAGM KIT 333



## AR NORTH AMERICA PUMPS

### RTX30 SERIES TRIPLEX PLUNGER PUMP

AR NORTH AMERICA PUMPS



- **MAX FLOW:** Varies by model - see below
- **MAX SPEED:** 1450 RPM
- **INLET:** 1" Female
- **BODY:** Die cast aluminum alloy
- **STROKE:** Varies by model - see below
- **MAX PRESSURE:** Varies by model - see below
- **MAX TEMP:** 140 °F
- **OUTLET:** 1/2" Female
- **BORE:** Varies by model - see below

PRICE	PART #	MODEL	MAX FLOW	MAX PRESSURE	BORE	STROKE
\$1,554.20	ARTX30	RTX30	7.9 GPM	4350 PSI	20 mm	23 mm
\$1,554.20	ARTX50	RTX50	13.2 GPM	2900 PSI	25 mm	23 mm
\$1,554.20	ARTX60	RTX60	15.8 GPM	4350 PSI	25 mm	28 mm
\$1,554.20	ARTX70	RTX70	18.5 GPM	1450 PSI	30 mm	23 mm
\$1,554.20	ARTX85	RTX85	22.5 GPM	2200 PSI	30 mm	28 mm
\$1,554.20	ARTX100	RTX100	26.4 GPM	1800 PSI	36 mm	22 mm



### RKA45G40HN PUMP

AR NORTH AMERICA PUMPS



- **MAX FLOW:** 4.5 GPM
- **MAX TEMP:** 140 °F
- **BORE:** 30 mm
- **MAX PRESSURE:** 4000 PSI
- **INLET:** 1/2" Female
- **STROKE:** 28 mm
- **MAX SPEED:** 1750 RPM
- **OUTLET:** 3/8" Female

**\$397.03** ARKA45G40HN



### XTA3G22N PUMP

AR NORTH AMERICA PUMPS



- **MAX FLOW:** 3.0 GPM
- **MAX TEMP:** 140 °F
- **BORE:** 18 mm
- **MAX PRESSURE:** 2200 PSI
- **INLET:** 1/2" Female
- **STROKE:** 9.6 mm
- **MAX SPEED:** 1750 RPM
- **OUTLET:** 3/8" Female

**\$324.39** ARXTA3G22N

## AR NORTH AMERICA PUMPS FOR PRESSURE CLEANING

### PRESSURE CLEANING PUMPS

AR NORTH AMERICA



**ARXMV25G26DF25**



**ARXWAM8G35N**



**ARRCA35G25N**

\$421.23	ARKA35G40HEF17	3.5 GPM	4000 PSI	1750 RPM	1 1/8" Shaft
\$397.03	ARKA35G40HN	3.5 GPM	4000 PSI	1750 RPM	24 mm Shaft
\$397.03	ARKA4G40HN	4 GPM	4000 PSI	1750 RPM	24 mm Shaft
\$115.23	ARMV25G24D	2.5 GPM	2400 PSI	3400 RPM	3/4" Shaft
\$115.23	ARMW22G24EZ	2.2 GPM	2400 PSI	3400 RPM	7/8" Shaft
\$250.32	ARRCA35G25N	3.5 GPM	2500 PSI	1750 RPM	24 mm Shaft
\$397.03	ARRK1528HN	3.96 GPM	4000 PSI	1450 RPM	24 mm Shaft
\$385.41	ARRKV35G40HD24	3.5 GPM	4000 PSI	3400 RPM	1" Hollow
\$364.34	ARRKV4G30AD	4 GPM	3000 PSI	3400 RPM	1" Hollow
\$426.07	ARRKV4G40HD	4 GPM	4000 PSI	3400 RPM	1" Hollow
\$242.10	ARSJV25G27D-F7	2.5 GPM	2700 PSI	3400 RPM	3/4" Hollow
\$789.21	ARSXWA55G50	5.5 GPM	5000 PSI	1750 RPM	24 mm Shaft
\$295.35	ARXMV25G26DF25	2.5 GPM	2600 PSI	3400 RPM	3/4" Shaft
\$314.72	ARXTA2G15EBAF8	2.11 GPM	1800 PSI	1750 RPM	3/4" Shaft
\$634.28	ARXWAM8G35N	8 GPM	3500 PSI	1750 RPM	24 mm Shaft
\$14.22	AR1836				1/2" Rail Kit
\$18.76	AR1836H				1 1/8" Rail Kit

## AR NORTH AMERICA PUMPS

New!



### Rcv3g27-PKG RCV BOXED PUMP PACKAGE

AR NORTH AMERICA PUMPS



**INCLUDES:**

- RCV3G25D-F7V21 - Pump
  - TPP140 - Thermal Relief Valve
  - AR1269120 - Detergent Tube with Filter
  - AL-QC3/8B - Quick Connect Coupler
  - AR7365 - 3/8" M Nipple
  - AR7366 - 3/4" F Nut
  - AR7369 - Inlet Filter
  - Gas Engine Flange - F7
- **MAX FLOW:** 3 GPM
  - **MAX PRESSURE:** 2500 PSI
  - **MAX SPEED:** 3400 RPM
  - **SHAFT SIZE:** 3/4"

**\$309.92** ARRCV3G27-PKG

New!



### RSV4G40-PKG RSV BOXED PUMP PACKAGE

AR NORTH AMERICA PUMPS



**INCLUDES:**

- RSV4G40HDF40EZ - Pump
  - AR7365 - 3/8" M Nipple
  - AR7366 - 3/4" F Nut
  - AR7369 - Inlet Filter
  - DETHOSE-FIL - Detergent Hose with Filter
  - AL-QC3/8B - Quick Connect Coupler
  - Gas Engine Flange - F40
- **MAX FLOW:** 4 GPM
  - **MAX PRESSURE:** 2500 PSI
  - **MAX SPEED:** 3400 RPM
  - **SHAFT SIZE:** 1"

**\$325.90** ARRSV4G40-PKG

New!



### RRV4G40-PKG RRV BOXED PUMP PACKAGE

AR NORTH AMERICA PUMPS



**INCLUDES:**

- RRV4G40HD-F24 - Pump
  - TPP140 - Thermal Relief Valve
  - AR7366 - 3/4" F Nut
  - AR7368 - 1/2" M Nipple
  - AR7369 - Inlet Filter
  - AR20242 - Gymatic Unloader
  - AL-QC3/8B - Quick Connect Coupler
  - Gas Engine Flange - F24
- **MAX FLOW:** 4 GPM
  - **MAX PRESSURE:** 4000 PSI
  - **MAX SPEED:** 3400 RPM
  - **SHAFT SIZE:** 1"

**\$415.96** ARRRV4G40-PKG

New!



### RRV4G40-VRT-PKG RRV BOXED PUMP PACKAGE

AR NORTH AMERICA PUMPS



**INCLUDES:**

- RRV4G40D - F24 pump
  - Brass Line Strainer w/ Cone Filter, GH Inlet
  - 3/8" QC steel plug
  - 3/8" QC brass socket
  - VRT3-310 EZ Start adjustable pressure unloader
  - 1/2" Black bypass hose thermal relief valve
- **MAX FLOW:** 4 GPM
  - **MAX PRESSURE:** 4000 PSI
  - **MAX SPEED:** 3400 RPM
  - **SHAFT SIZE:** 1" Hollow

**\$380.62** ARRRV4G40-VRT-PKG

New!



### RKV4G40-PKG REPLACEMENT PLUNGER PUMP KIT PACKAGE

AR NORTH AMERICA PUMPS



**INCLUDES:**

- Kit Manual
  - RRV4G40HD-F24 VR3 - Pump
  - TPP140 - Thermal Relief Valve
  - VR35 Unloader
  - F24 Gas Engine Flange
  - AR7300 - 1/2" Garden Hose Adaptor w/ Spring
- **MAX FLOW:** 4 GPM
  - **MAX PRESSURE:** 4000 PSI
  - **MAX SPEED:** 3400 RPM
  - **SHAFT SIZE:** 1" Hollow

**\$522.99** ARRKV4G40-PKG

## SANDPIPER® PUMPS

### SANDPIPER® STANDARD DUTY BALL NON-METALLIC PUMPS

SANDPIPERPUMPS



- Standard duty non-metallic pumps are ideally suited for highly corrosive fluids, intermittent/on-demand, portable, low abrasive fluids, and suspended solids. Standard duty non-metallic pumps are constructed in polypropylene, PVDF, conductive acetal and conductive polypropylene with TPE (thermal plastic elastomers) and PTFE options in diaphragms and check valves.

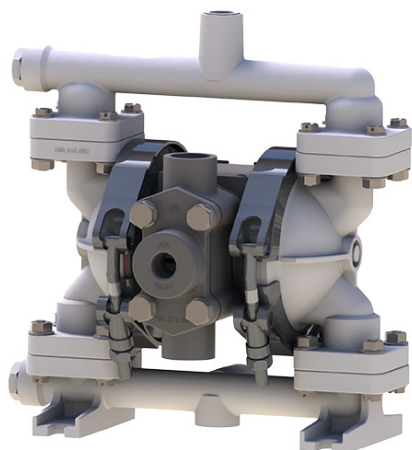

### 1/4" PB SERIES

SANDPIPER STANDARD DUTY BALL NON-METALLIC PUMPS



PRICE	PUMP #	BODY	DIAPHRAGM	PORTS	MAX. FLOW
<b>\$394.28</b>	<b>SP04PS</b>	Poly	Santoprene	1/4"	5 GPM @ 6 CFM
<b>\$474.50</b>	<b>SP04PT</b>	Poly	Teflon	1/4"	5 GPM @ 6 CFM



### 1/4" PB SERIES KIT

SANDPIPER STANDARD DUTY BALL NON-METALLIC PUMP



PRICE	KIT #	PUMP #	DESCRIPTION
<b>\$219.10</b>	<b>SPK476129</b>	SP04PS	1/4" Air End Kit

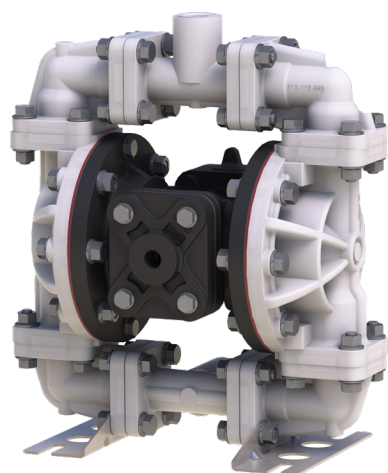

### 1/2" S05 SERIES

SANDPIPER STANDARD DUTY BALL NON-METALLIC PUMPS



- The only pump with the anti-stall guarantee

PRICE	PUMP#	BODY	DIAPHRAGM	PORTS	MAX. FLOW
<b>\$826.01</b>	<b>SP08PPS</b>	Poly	Santoprene	1/2"	14 GPM @ 16 CFM
<b>\$1,001.00</b>	<b>SP08PT</b>	Poly	Teflon	1/2"	14 GPM @ 16 CFM
<b>\$826.01</b>	<b>SP08PU</b>	Poly	Urethane	1/2"	14 GPM @ 16 CFM



### 1/2" S05 SERIES KITS

SANDPIPER STANDARD DUTY BALL NON-METALLIC PUMP



PRICE	KIT#	PUMP #	DESCRIPTION
<b>\$357.69</b>	<b>SPK08A</b>	SP08PPS	Air End Kit
<b>\$109.21</b>	<b>SPK08DS</b>	SP08PPS	Santoprene Diaphragm Kit
<b>\$389.21</b>	<b>SPK08DT</b>	SP08PT	Teflon Diaphragm Kit
<b>\$139.31</b>	<b>SPK08DU</b>	SP08PU	Urethane Diaphragm Kit

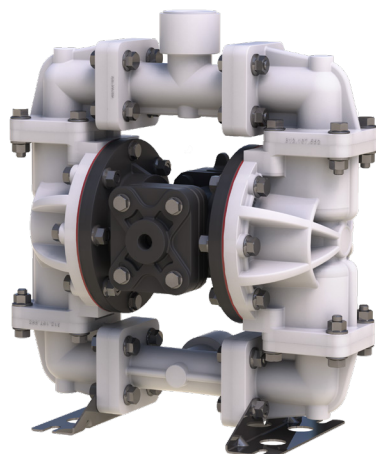

### 3/4" S07 SERIES

SANDPIPER STANDARD DUTY BALL NON-METALLIC PUMPS



PRICE	PUMP #	BODY	DIAPHRAGM	PORTS	MAX. FLOW
<b>\$966.00</b>	<b>SP12PS</b>	Poly	Santoprene	3/4"	23 GPM @ 20 CFM
<b>\$1,004.50</b>	<b>SP12PT</b>	Poly	Teflon	3/4"	23 GPM @ 20 CFM



**CALIFORNIA PROPOSITION 65 NOTE:** some items on this page may fall under the Proposition 65 act. Please consult the State of California Proposition 65 list ([oehha.ca.gov/proposition-65/proposition-65-list](http://oehha.ca.gov/proposition-65/proposition-65-list)) to learn more and to see a comprehensive list of Proposition 65 chemicals.



## VERSAMATIC® PUMPS

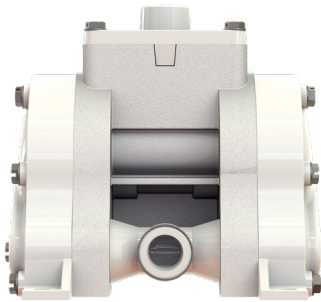

### 3/8" DIAPHRAGM PUMP

VERSAMATIC PUMPS



- Can be mounted in any position (vertical, horizontal, upside down)
- Inlet/discharge manifolds can be rotated to meet your mounting needs
- Available in polypropylene or Kynar wetted sections and fitted with Santoprene or Teflon for superior chemical resistance

PRICE	PART #	BODY	DIAPHRAGM	PORT SIZE	MAX FLOW
<b>\$438.19</b>	<b>VME8PS</b>	Poly	Santoprene	3/8"	6.8 GPM
<b>\$502.61</b>	<b>VME8PT</b>	Poly	Teflon	3/8"	6.8 GPM
<b>\$1,111.60</b>	<b>VME8KT</b>	Kynar	Teflon	3/8"	6.8 GPM

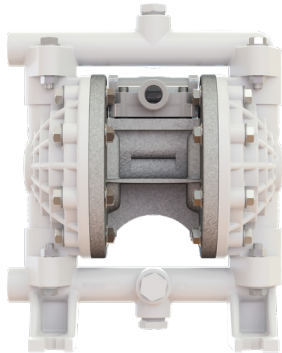

### 1/2" DIAPHRAGM PUMP

VERSAMATIC PUMPS



- Drop in replacement for ARO 1/2" (same center line & foot print)
- Multiple porting options
- Patented non-stalling, anti-icing, lubrication free air valve system
- Available in Kynar/Teflon for superior chemical resistance

PRICE	PART #	BODY	DIAPHRAGM	PORT SIZE	MAX FLOW
<b>\$656.61</b>	<b>VME5PS</b>	Poly	Santoprene	1/2"	11 GPM
<b>\$795.49</b>	<b>VME5PT</b>	Poly	Teflon	1/2"	10 GPM

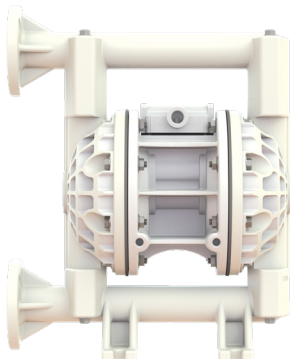

### 1" DIAPHRAGM PUMP

VERSAMATIC PUMPS



- Patented non-stalling, anti-icing, lubrication-free air valve system
- Rugged 150 lbs ANSI-DIN flanges

PRICE	PART #	BODY	DIAPHRAGM	PORT SIZE	MAX FLOW
<b>\$1,155.70</b>	<b>VME1PS</b>	Poly	Santoprene	1"	43 GPM
<b>\$1,377.59</b>	<b>VME1PT</b>	Poly	Teflon	1"	36 GPM
<b>\$2,697.11</b>	<b>VME1KT</b>	Kynar	Teflon	1"	36 GPM

### DIAPHRAGM PUMP KITS

VERSAMATIC PUMPS



PRICE	PART #	DESCRIPTION
<b>\$115.74</b>	<b>VMKE8DS</b>	Santoprene Wet End Kit 3/8" (for VME8PS)
<b>\$280.76</b>	<b>VMKE8DT</b>	Teflon Wet End Kit 3/8" (for VME8PT & VME8KT)
<b>\$109.77</b>	<b>VMKE5DS</b>	Santoprene Wet End Kit 1/2" (for VME5PS)
<b>\$442.20</b>	<b>VMKE5DT</b>	Teflon Diaphragm Kit
<b>\$176.23</b>	<b>VMKE1DS</b>	Santoprene Wet End Kit 1" (for VME1PS)

PRICE	PART #	DESCRIPTION
<b>\$605.85</b>	<b>VMKE1DT</b>	Teflon Wet End Kit 1" (for VME1PS)
<b>\$102.29</b>	<b>VMKE8A</b>	Air End Kit 3/8" (for all E8 models)
<b>\$214.29</b>	<b>VMKE5A</b>	Air End Kit 1/2" (for all E5 models)
<b>\$203.09</b>	<b>VMKE1A</b>	Air End Kit 1" (for all E1 models)



### MANIFOLDS

VERSAMATIC PUMPS



PRICE	PART #	DESCRIPTION	INLET PORT	OUTLET PORT	DISTRIBUTION PORTS	PSI	MAX. FLUID TEMP	MOUNTING THREAD
<b>\$22.81</b>	<b>VM7003022</b>	Polypropylene (glass filled)	9/16-18" UNF	3/8-18" FNPT	1/4-18 FNPT	150	175°	1/4"

## PENTAIR SHURFLO PUMPS



### 166 SERIES AIR DRIVEN PUMPS

PENTAIR SHURFLO AIR-DRIVEN PUMPS



- The Pentair Shurflo 166 Air Operated Demand Pumps employ a dual diaphragm design, with a patented fast action switching mechanism allowing for consistent flow and pressure. They are built for the toughest pumping applications and are available in a variety of elastomers that allow them to be compatible with mild caustic or acidic fluids. Ideal for chemical transfer, injection and spraying.
- 2-chamber dual diaphragm • Positive displacement • On-demand operation
- **BODY:** Polypropylene • **PRESSURE:** 30-60 PSI • **MAX TEMP:** 120° F • **DIAPHRAGM:** Varies

PRICE	PART #	DIAPHRAGM
<b>\$115.29</b>	<b>SF16620056</b>	EPDM
<b>\$150.71</b>	<b>SF16620036</b>	Viton

### 8000 SERIES DIAPHRAGM PUMPS

PENTAIR SHURFLO DIAPHRAGM PUMPS



- The 8000 Series diaphragm pump is Pentair Shurflo's most widely used industrial pump. With spherically shaped valves and automatic demand switch, these pumps deliver consistent, dependable operation and priming. Up to 1.8 GPM (6.8 l/min).



PRICE	PART #	DESCRIPTION	GPM	PSI	PORT SIZE
<b>\$134.41</b>	<b>SF8000151296</b>	Low Flow Demand Pump W/ Internal Bypass 24 VDC	1	60	3/8"
<b>\$141.08</b>	<b>SF8000343236</b>	Standard Demand Pump 12VDC	1.2	60	3/8"
<b>\$147.73</b>	<b>SF8000532256</b>	Standard Demand Pump w/Internal Bypass 115VAC	1.4	60	3/8"
<b>\$147.73</b>	<b>SF8000533236</b>	Standard Demand Pump 115VAC	1.4	60	3/8"
<b>\$135.13</b>	<b>SF8000533250</b>	Standard Internal Bypass Pump 115VAC	1.4	50	3/8"
<b>\$107.83</b>	<b>SF8000543236</b>	Standard Demand Pump 12 VDC	1.8	60	3/8"
<b>\$112.13</b>	<b>SF8000543238</b>	High Pressure Demand Pump 12 VDC	1.8	100	3/8"
<b>\$146.10</b>	<b>SF8000633236</b>	Transfer Pump 115VAC	1.4	60	3/8"
<b>\$120.45</b>	<b>SF8000643236</b>	Standard Demand Pump 12 VDC	1.8	60	3/8"
<b>\$169.73</b>	<b>SF8000812288</b>	High Pressure Demand Pump w/Bypass 115VAC	1.4	100	3/8"
<b>\$125.34</b>	<b>SF8005233236</b>	Standard Demand Pump 115VAC	1.4	60	3/8"
<b>\$150.02</b>	<b>SF8000713238</b>	High Pressure Demand Pump 115VAC	1.6	100	3/8"
<b>\$163.38</b>	<b>SF8000813238</b>	High Pressure Demand Pump 115VAC	1.6	100	3/8"
<b>\$168.70</b>	<b>SF8030813239</b>	Standard Demand Pump 12 VDC	1.8	150	3/8"
<b>\$128.00</b>	<b>SF8005733255</b>	Standard Demand Pump w/Internal Bypass 115VAC	1.6	60	3/8"
<b>\$107.83</b>	<b>SF8009543236</b>	ShurFlo Pump 12VDC	1.7	60	3/8"
<b>\$189.16</b>	<b>SF8020833238</b>	ShurFlo Pump 115V	1.5	100	3/8"
<b>\$44.20</b>	<b>SFK9439505</b>	ShurFlo Viton Diaphragm Kit	For 8000-033-236 & 343-236		
<b>\$14.74</b>	<b>SF9437900</b>	Upper Housing	For 8000 Series Diaphragm Pumps w/o Bypass		

ALL PENTAIR BRANDS ARE TRADEMARKS OF PENTAIR.



Whether you need to pump water for your RV, marine, agricultural, automotive, or floor care operation, Pentair Shurflo pumps are the answer! Innovative designs and high performance materials combine to deliver a high quality electric diaphragm pump solution that many operators trust to provide easy, maintenance-free performance.

## PENTAIR SHURFLO PUMPS



### SLV SERIES PUMP PENTAIR SHURFLO PUMPS



- Ideal for low volume intermittent duty applications requiring a compact pump with low power consumption.
- Unique design has no metal parts in the fluid path for maximum chemical resistance.
- Automatic demand operation and elastomers that handle a wide variety of fluids offer great versatility.
- Perfect for low volume spraying and transfer.
- **PORTS:** 3/8" Barb
- **VOLTAGE:** 12 VDC
- **FLOW:** 1 GPM
- **PSI:** Varies - see below
- **VALVES:** Viton

PRICE	PART #	DESCRIPTION	PSI
<b>\$64.46</b>	<b>SFSLV10AA40</b>	Automatic Demand Pump with Integral on/off Switch	45
<b>\$61.10</b>	<b>SFSLV10AA41</b>	Automatic Demand Pump	40



### 5050 SERIES PUMP PENTAIR SHURFLO PUMPS



- Pump Type - Standard or Bypass
- **PORTS:** 1/2"
- **FLOW:** 5.3 GPM
- **PRESSURE:** 60 PSI
- **PUMP BODY:** Polypropylene
- **DIAPHRAGM:** Santoprene
- **VOLTAGE:** 12 VDC
- **VALVES:** Viton
- **SHUT-OFF:** 60 PSI

**\$201.40** SF50501311D011



### GENERAL PURPOSE PUMPS PENTAIR SHURFLO PUMPS



- Compact, rugged and reliable, the 100 is a positive displacement pump for flooded inlet, low volume, and low-pressure applications. Perfect where a low volume fill pump is needed, the unique wobbler design has no valves, and can pump a wide range of chemicals and fluids. Available in 12 VDC. Pump must be mounted below the supply tank to prime. Not for applications that require dry running.
- Easy installation
- Unique design eliminates valves
- **OUTLET PORT:** 3/8" Barb
- **FLOW:** 1 GPM (open)
- **O-RINGS:** EPDM
- **INLET PORT:** 3/8" Barb
- **PRESSURE:** 15 PSI
- **LIP SEAL:**
- **HOUSING:** Ryton
- **VOLTAGE:** 12 VDC

**\$46.79** SF10000021

### 2088 SERIES DIAPHRAGM PUMPS PENTAIR SHURFLO PUMPS



- Deliver reliable performance in high flow, moderate pressure applications.
- They are used in a variety of spraying, and transferring applications
- They are available in a variety of chemical-resistant materials, can be mounted in any position, and are designed for easy maintenance.

PRICE	PART #	DESCRIPTION	GPM	PSI	PORT SIZE
<b>\$128.51</b>	<b>SF2088343435</b>	Standard Demand Pump 12 VDC	3.0	45	1/2"
<b>\$200.21</b>	<b>SF2088394144</b>	Standard Pump with 6' Power Cord 115VAC	3.0	40	1/2"
<b>\$114.07</b>	<b>SF2088443144</b>	Standard Demand Pump 12 VDC	3.5	45	1/2"
<b>\$118.90</b>	<b>SF2088474144</b>	Standard Demand Pump	3.0	45	1/2"
<b>\$185.18</b>	<b>SF2088514144</b>	Standard Demand Pump 12 VDC	4.0	45	1/2"
<b>\$216.77</b>	<b>SF2088313445</b>	Premium Pump w/Fin Cooled Motor 12VDC	3.5	45	1/2"
<b>\$178.71</b>	<b>SF2088514500</b>	Bypass No Control Pump 12VDC	4.0	45	1/2"
<b>\$170.07</b>	<b>SF2088594144</b>	Standard Demand Pump 115VAC	3.0	45	1/2"
<b>\$150.89</b>	<b>SF2088594154</b>	Standard Demand Pump 115VAC	3.3	45	1/2"

ALL PENTAIR BRANDS ARE TRADEMARKS OF PENTAIR



## YAMADA® AIR OPERATED DIAPHRAGM PUMPS

TOP  
SELLER!

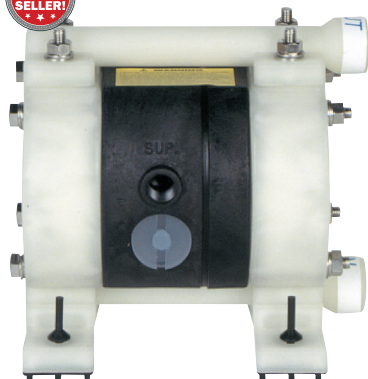

### NDP-5FPT SERIES PUMP

YAMADA AIR OPERATED DIAPHRAGM PUMPS



- **AIR EXHAUST:** 3/8" Female NPT (includes silencer)
- **AIR INLET:** 1/4" Female NPT (includes ball valve)
- **MAX. LIQUID TEMP.:** 180 °F (82 °C)
- **FLOW:** 3.1 GPM
- **AIR SUPPLY PRESSURE:** 20 to 100 PSI (1.4 to 7 kgf/cm<sup>2</sup>)
- **PORTS:** 1/4" Female NPT
- **O-RINGS:** Teflon
- **FLAT VALVE:** Teflon
- **DIAPHRAGMS:** Teflon
- **BODY:** Polypropylene

**\$289.29** YANDP5FPT



### NDP-5FPT SERIES PUMP KITS

YAMADA AIR OPERATED DIAPHRAGM PUMPS



<b>\$108.00</b>	<b>YANDK5T</b>	(2) 771093 - DIAPHRAGM 5T, (4) 771094 - FLAT VALVE 5PP-T, (4) 643003 - O-RING, (4) 643013 - O-RING, (2) 643015 - O-RING	(Old Style Repair Kit) For Models Before Serial #228480
<b>\$108.00</b>	<b>YANDK5T-2</b>	(2) 771093 - DIAPHRAGM 5T, (4) 771094 - FLAT VALVE 5PP-T, (4) 643003 - O-RING, (6) 643015 - O-RING	(New Style Repair Kit) For Models After Serial #228480
<b>\$144.00</b>	<b>YANDK5AM</b>	(5) 771098 - SEAL RING, (1) 640002 - O-RING, (1) 640017 - O-RING, (2) 640000 - O-RING, (2) 685752 - V-PACKING, (2) 640139 - O-RING, (1) 771980 - GASKET, (2) 771239 - CUSHION, (2) 709319 - SPRING, (1) 771465 - FILTER, (6) 771097 - O-RING, (1) 771132 - TOOL 5/15	(Air Motor Rebuild Kit)

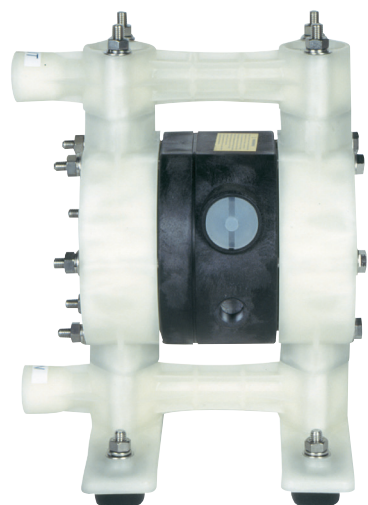

### NDP-15FPT SERIES PUMP

YAMADA AIR OPERATED DIAPHRAGM PUMPS



- **AIR EXHAUST:** 3/8" Female NPT (includes silencer)
- **AIR INLET:** 1/4" Female NPT (includes ball valve)
- **MAX. LIQUID TEMP.:** 180 °F (82 °C)
- **FLOW:** 13.5 GPM
- **AIR SUPPLY PRESSURE:** 20 to 100 PSI (1.4 to 7 kgf/cm<sup>2</sup>)
- **PORTS:** 1/2" Female NPT
- **O-RINGS:** Teflon
- **FLAT VALVE:** Teflon
- **DIAPHRAGMS:** Teflon
- **BODY:** Polypropylene

**\$428.65** YANDP15FPT



### NDP-15FPT SERIES PUMP KITS

YAMADA AIR OPERATED DIAPHRAGM PUMPS



<b>\$131.00</b>	<b>YANDK15AM</b>	(1) 771347 - GASKET, (1) 640022 - O-RING, (1) 640002 - O-RING, (6) 683123 - O-RING, (5) 771484 - SEAL RING, (2) 771483 - CUSHION, (2) 640144 - O-RING, (2) 640020 - O-RING, (2) 684284 - V-PACKING, (2) 771342 - CUSHION	(Air Motor Rebuild Kit)
<b>\$174.00</b>	<b>YANDK15T</b>	(8) O-RING 643027, (4) FLAT VALVE 771340, (2) DIAPHRAGM 770933, (4) O-RING - 643005	(Liquid Side Repair Kit)

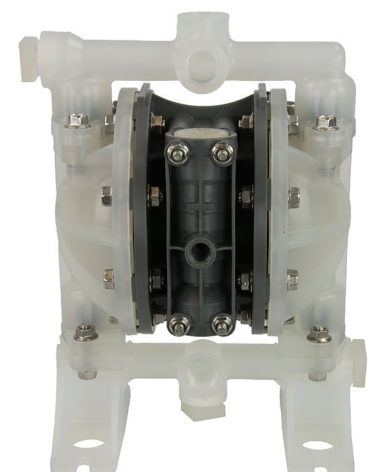

### G15 SERIES PUMPS

YAMADA AIR OPERATED DIAPHRAGM PUMPS



- **AIR EXHAUST:** 3/8" Female NPT (includes silencer)
- **AIR INLET:** 1/4" Female NPT
- **MAX. LIQUID TEMP.:** 180 °F (100 °C)
- **FLOW:** 16.6 GPM
- **AIR SUPPLY PRESSURE:** 20-100 PSI (1.4 to 7 kgf/cm<sup>2</sup>)
- **PORTS:** 1/2" Female NPT
- **O-RINGS:** Teflon or Santoprene
- **FLAT VALVE:** Teflon or Santoprene
- **DIAPHRAGMS:** Teflon or Santoprene

PRICE	PART #	DIAPHRAGM, O-RINGS, BALLS
<b>\$522.50</b>	<b>YAG15PS11</b>	Santoprene
<b>\$581.50</b>	<b>YAG15PT11</b>	PTFE (Teflon)



### G15 SERIES PUMP KITS

YAMADA AIR OPERATED DIAPHRAGM PUMPS



<b>\$134.00</b>	<b>YAKG15PS</b>	(2) 640147 O-RING, (2) 773315 DIAPHRAGM, (4) 773424 BALL, (4) 684114 O-RING	(Liquid Side Repair Kit)
-----------------	-----------------	---	--------------------------

**CALIFORNIA PROPOSITION 65 NOTE:** some items on this page may fall under the Proposition 65 act. Please consult the State of California Proposition 65 list ([oehha.ca.gov/proposition-65/proposition-65-list](http://oehha.ca.gov/proposition-65/proposition-65-list)) to learn more and to see a comprehensive list of Proposition 65 chemicals.

## YAMADA® AIR OPERATED DIAPHRAGM PUMPS

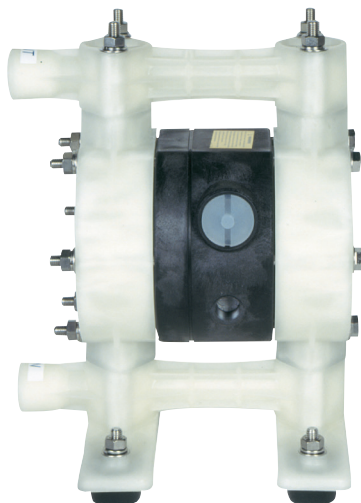

### YANDP15FPS-PLS POLYPROPYLENE/SANTOPRENE NDP-15 SERIES PUMP

YAMADA AIR OPERATED DIAPHRAGM PUMPS



- **AIR EXHAUST:** 3/8" Female NPT (includes silencer)
- **AIR INLET:** 1/4" Female NPT (includes ball valve)
- **MAX. LIQUID TEMP.:** 180° F (82° C)
- **FLOW:** 13.5 GPM
- **AIR SUPPLY PRESSURE:** 20 to 100 PSI (1.4 to 7 kgf/cm<sup>2</sup>)
- **PORTS:** 1/2" Female NPT
- **O-RINGS:** EPDM
- **FLAT VALVE:** Teflon
- **DIAPHRAGMS:** Santoprene

**\$535.00** YANDP15FPS-PLS



### YANDP15FPS-PLS POLYPROPYLENE NDP-15 SERIES PUMP KITS

YAMADA AIR OPERATED DIAPHRAGM PUMPS



<b>\$114.00</b>	<b>YANDK15S</b>	(2) 771972 - DIAPHRAGM 10/15 SANTOPRENE, (4) 771340 - FLAT VALVE 15T, (8) 684115 - O-RINGS	(Liquid Side Repair Kit)
<b>\$131.00</b>	<b>YANDK15AM</b>	(1) 771347 - GASKET, (1) 640022 - O-RING, (1) 640002 - O-RING, (6) 683123 - O-RING, (5) 771484 - SEAL RING, (2) 771483 - CUSHION, (2) 640144 - O-RING, (2) 640020 - O-RING, (2) 684284 - V-PACKING, (2) 771342 - CUSHION	(Air Motor Rebuild Kit)

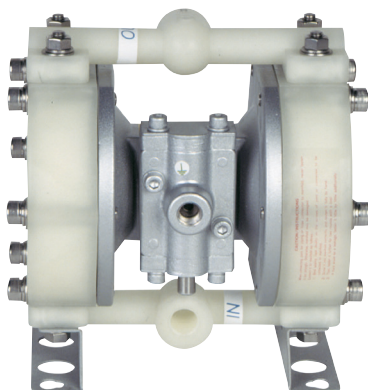

### YADP10BPT POLYPROPYLENE/TEFLON DP-10 SERIES PUMP

YAMADA AIR OPERATED DIAPHRAGM PUMPS



- **AIR EXHAUST:** 3/8" Female NPT (includes silencer)
- **AIR INLET:** 1/4" Female NPT (includes ball valve)
- **MAX. LIQUID TEMP.:** 180° F (82° C)
- **FLOW:** 6.0 GPM
- **AIR SUPPLY PRESSURE:** 20 to 100 PSI (1.4 to 7 kgf/cm<sup>2</sup>)
- **PORTS:** 3/8" Female NPT
- **O-RINGS:** Teflon
- **FLAT VALVE:** Teflon
- **DIAPHRAGMS:** Teflon

**\$404.18** YADP10BPT



### YADP10BPT POLYPROPYLENE DP-10 SERIES PUMP KITS

YAMADA AIR OPERATED DIAPHRAGM PUMPS



<b>\$154.00</b>	<b>YADK10PT</b>	(2) 770933 - DIAPHRAGM 10T, (4) 770931 - BALL 10T, (4) 643005 - O-RING, (4) 643018 - O-RING	(Liquid Side Repair Kit)
<b>\$93.00</b>	<b>YANDK115AM</b>	(2) 640131 - O-RING, (4) 684900 - O-RING, (1) 771358 - GASKET, (4) 684284 - V-PACKING, (1) 801404 - SPOOL	(Air Motor Rebuild Kit)

## STENNER® PUMPS

### STENNER PUMP COMPANY

STENNER PUMPS



- Self-priming: No foot valve assemblies required
- External dial ring allows full adjustment from 5 to 100% of maximum flow
- Consistent output and uniform flow
- Pressure rated up to 100 PSI
- **PERISTALTIC ADVANTAGE**- With peristaltic pumps you don't need diaphragms or foot valves while allowing the system to be completely self-priming
- Low maintenance: Primary modular components are easily replaceable without tools
- Wall or shelf moun
- Ideal for hyper-concentrates and a wide variety of car wash solutions
- International voltages and connections available

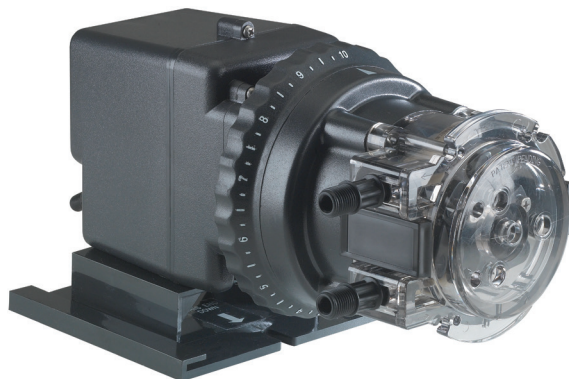

### 85 SERIES SINGLE HEAD PUMP

STENNER PUMPS®



- 120V single head pump
- Select suction/discharge tubing size 1/4" or 3/8"
- Select pump tube material\*
- \* Versilon is recommended for oil based chemicals (drying agents, waxes and polymer conditioners)

	PART #	CONN. SIZE	PUMP TUBE MATERIAL	MAX. OUTPUT
<b>CALL FOR PRICING</b>	SP85MJH7A3S	3/8"	Santoprene	3.6 oz./min.
	SP85MJH7A1S	1/4"	Santoprene	3.6 oz./min.
	SP85MJH2A3T	3/8"	Versilon	1.5 oz./min.
	SP85MJH2A1S	1/4"	Santoprene	1.5 oz./min.
	SP85MJH1A3S	3/8"	Santoprene	.45 oz./min.
	SP85MJH1A1S	1/4"	Santoprene	.45 oz./min.

**CALIFORNIA PROPOSITION 65 NOTE:** some items on this page may fall under the Proposition 65 act. Please consult the State of California Proposition 65 list ([oehha.ca.gov/proposition-65/proposition-65-list](http://oehha.ca.gov/proposition-65/proposition-65-list)) to learn more and to see a comprehensive list of Proposition 65 chemicals.

## GRACO® HUSKY PUMPS



### HUSKY 307 SERIES

GRACO PUMPS



- **OUTLET PORT:** 3/8" NPTF
- **INLET PORT:** 3/8" NPTF
- **FLOW:** 6.5 GPM
- **PRESSURE:** 100 PSI
- **MAX TEMP.:** 150° F
- **BODY:** Polypropylene

<b>\$437.76</b>	<b>GD32966</b>	Santoprene
<b>\$564.68</b>	<b>GD32911</b>	Teflon

#### REPAIR KITS

<b>\$200.61</b>	<b>GDK263720</b>	Santoprene
<b>\$265.49</b>	<b>GDK03911</b>	Teflon



### HUSKY 515 SERIES

GRACO PUMPS



- **OUTLET PORT:** 1/2" NPTF
- **INLET PORT:** 1/2" NPTF
- **FLOW:** 15 GPM
- **PRESSURE:** 100 PSI
- **MAX TEMP.:** 150° F
- **BODY:** Polypropylene

<b>\$563.92</b>	<b>GD52966</b>	Santoprene
<b>\$779.00</b>	<b>GD52911</b>	Teflon

#### REPAIR KITS

<b>\$226.65</b>	<b>GDK5966</b>	Santoprene
<b>\$301.41</b>	<b>GDK5911</b>	Teflon



### HUSKY 205 SERIES

GRACO PUMPS



- **OUTLET PORT:** 1/4" NPTF
- **INLET PORT:** 1/4" NPTF
- **FLOW:** 5 GPM
- **PRESSURE:** 100 PSI
- **MAX TEMP.:** 180° F
- **BODY:** Polypropylene

<b>\$321.48</b>	<b>GD12096</b>	Santoprene
<b>\$441.56</b>	<b>GD12091</b>	Teflon

#### REPAIR KITS

<b>\$80.46</b>	<b>GDK01096</b>	Santoprene
<b>\$122.07</b>	<b>GDK01091</b>	Teflon



### HUSKY 1050 SERIES

GRACO PUMPS



- **OUTLET PORT:** 1" NPTF
- **INLET PORT:** 1" NPTF
- **FLOW:** 50 GPM
- **PRESSURE:** 125 PSI
- **BODY:** Polypropylene

<b>\$1,265.40</b>	<b>GD649029</b>	Santoprene
<b>\$1,436.40</b>	<b>GD649034</b>	Teflon

#### REPAIR KITS

<b>\$325.24</b>	<b>GDP24B627</b>	Teflon
-----------------	------------------	--------



### FAST-FLO 55 GALLON DRUM PUMP

GRACO PUMPS



- **CONSTRUCTION:** 304 Stainless Steel
- **PACKING:** PTFE
- **FLOW:** 4.0 GPM
- **MAX PRESSURE:** 180 PSI
- **MAX PUMP SPEED:** 100 CPM
- **AIR INLET:** 1/4"
- **FLUID OUTLET:** 3/4"
- Air powered for high reliability and low cost
- *Continuous or dead end transfer*

<b>\$1,991.20</b>	<b>GD237129</b>
-------------------	-----------------



### HUSKY DRUM PUMP PACKAGE

GRACO PUMPS



- **MAX PRESSURE:** 100 PSI
- **AIR INLET:** 1/4"
- **AIR EXHAUST:** 3/8"
- **FLUID INLET:** 1/2"
- **FLOW:** 15 GPM
- **BODY:** Polypropylene
- **DIAPHRAGMS:** Teflon
- **BALL CHECKS:** Teflon
- **SUCTION TUBE:** Poly
- Runs dry without damage

<b>\$1,151.40</b>	<b>GD233051</b>	Pump
-------------------	-----------------	------

#### REPAIR KITS

<b>\$354.27</b>	<b>GDK5911</b>	Teflon
<b>\$95.18</b>	<b>GDK241657</b>	Air Valve



## AQUATEC PUMPS

### 5800 SERIES PUMPS

AQUATEC



- **PORTS:** 3/8" John Guest Push-to-Connect
- **DIAPHRAGM:** Santoprene
- **HOUSINGS:** Polypropylene
- **APPLICATION:** Pressurized water delivery

PRICE	PART #	PSI	GPM	MAX. TEMP	VOLTAGE	LEADS	PRIME
<b>\$102.37</b>	<b>ATP1000</b>	60	0.9	140°F	115 VAC/60 Hz	12" motor leads	7 ft.
<b>\$103.93</b>	<b>ATP1005</b>	60	0.9	140°F	115 VAC/60 Hz	12" motor leads	5.5 ft.
<b>\$103.93</b>	<b>ATP1010</b>	60	1.22	140°F	115 VAC/60 Hz	12" motor leads	7 ft.
<b>\$105.35</b>	<b>ATP1015</b>	100	1.22	140°F	115 VAC/60 Hz	12" motor leads	7 ft.

**\* ATP1035 IS A VARIABLE SPEED PUMP!**



### 5800 SERIES CARPET CLEANING EQUIPMENT PUMPS

AQUATEC



- **PORTS:** 3/8" NPT Female
- **DIAPHRAGM:** Santoprene
- **VALVES:** Viton
- **HOUSINGS:** Nylon
- **MAX TEMP:** 170°F
- **MAX. PRESSURE:** Varies, see chart
- **PRIME:** 9 feet
- **MOTOR LEADS:** 12"

PRICE	PART #	PRESSURE SWITCH	GPM	VOLTAGE
<b>\$141.75</b>	<b>ATP1025</b>	170 PSI	0.5 GPM @ 145 PSI w/ #2 nozzle tip	12 VDC
			0.98 GPM @ 90 PSI w/ #6 nozzle tip	
<b>\$147.00</b>	<b>ATP1030</b>	220 PSI	0.55 GPM @ 175 PSI w/ #2 nozzle tip	115 VAC
			0.98 GPM @ 90 PSI w/ #6 nozzle tip	
<b>\$164.59</b>	<b>ATP1060</b>	120 PSI	0.55 GPM @ 175 PSI w/ #2 nozzle tip	115 VAC
			0.98 GPM @ 90 PSI w/ #6 nozzle tip	



### 550 SERIES PUMPS

AQUATEC



- **PORTS:** 1/2" NPT Female
- **DIAPHRAGM:** Santoprene
- **VALVES:** EPDM
- **HOUSINGS:** Polypropylene
- **MAX TEMP:** 140°F
- **MAX. PRESSURE:** 60 PSI
- **PRIMARY APPLICATION:** beverage/drinking water
- **MOTOR LEADS:** 12"

PRICE	PART #	GPM	VOLTAGE	PRIME
<b>\$104.98</b>	<b>ATP1040</b>	3.2	115 VAC	10 ft.
<b>\$139.65</b>	<b>ATP1045</b>	3.2	115 VAC	10 ft.

PRICE	PART #	GPM	VOLTAGE	PRIME
<b>\$111.29</b>	<b>ATP1050</b>	4.25	12 VDC	11 ft.
<b>\$111.29</b>	<b>ATP1055</b>	4.5	24 VDC	10 ft.

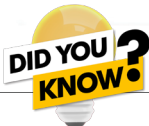

Aquatec's 3-chamber and 5-chamber diaphragm pumps are used for a variety of water delivery applications. Commonly used either to pressurize water from an atmospheric tank, to deliver purified water to a specific point of use, or simply to increase pressure when required. Most models are designed for intermittent duty, although some models are rated for continuous operation.

Aquatec provides professional-quality pump systems for beverage and water delivery, industrial water transfer and floor care applications. Aquatec pumps feature thermal caps on motors for safe usage and temperature control.

Each Aquatec pump boasts reliable performance and great service life for your facility!