

# BAY ACCESSORIES

## WRINGERS & SINKS

### THE HANDWRINGER BY LAKE CITY

LAKE CITY INDUSTRIES

- Removes twice as much water as spin dry!
- Has adjustable spin
- Attach to stationary or portable tubs (round or square)
- Rust-resistant, all steel frame, steel tube handle, and zinc plate finish
- Removes 90% of water from items
- Clamps open to 1¾"
- Equipped with rolls 12" x 1⅞"

**\$256.10** HW763

### REPLACEMENT PARTS FOR THE HANDWRINGER BY LAKE CITY

LAKE CITY INDUSTRIES

|                |                 |                          |                 |                 |                       |
|----------------|-----------------|--------------------------|-----------------|-----------------|-----------------------|
| <b>\$44.48</b> | <b>HWP80135</b> | Top Assembly             | <b>\$44.48</b>  | <b>HWP25105</b> | Crank Handle Complete |
| <b>\$27.92</b> | <b>HWP3270</b>  | Wooden Block Bearing Set | <b>\$144.31</b> | <b>HWP4200</b>  | Upper/Lower Roll Set  |



**C-CLAMP STYLE**

### TWO PART HAND WRINGER CONVERSION KIT

LAKE CITY INDUSTRIES

- Convert your Lake City hand wringer into a flat-mount base wringer - similar to a Dyna-Jet wringer. The kit contains two identical metal parts that are attached to the wringer to make the conversion.
- Durable metal construction
- Converts a Lake City wringer to a flat-mount wringer (Dyna-Jet type)

**\$24.37** HW763-CK



### FREE STANDING STAINLESS STEEL SINK

DRALCO

- 36" H x 50¼" W x 16" D
- 2 faucet holes
- 1½" drain
- Handwringer NOT INCLUDED

**\$1,486.36** HWD5718

**HANDWRINGER NOT INCLUDED**

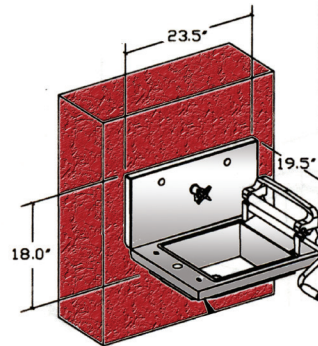

### WALL MOUNT STAINLESS STEEL SINK

DRALCO

- 18" H x 23½" W x 19½" D
- Includes solenoid and faucet handle cutouts
- Drain Outlet: 1" FPT
- Handwringer NOT INCLUDED

**\$726.92** HWD3287

**HANDWRINGER NOT INCLUDED**

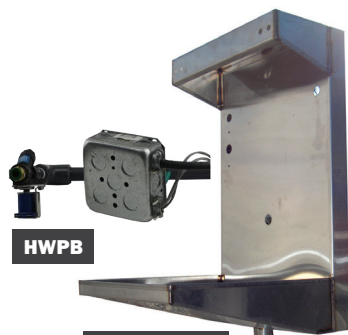

**HWPB**

**HWKRSINK**

### STAINLESS STEEL WRINGER SINK FOR HANDWRINGERS

DRALCO

- 24" H x 15" W x 16" D
- Perfect for mounting handwringer
- Also available: Push Button Water Package

**\$282.42** **HWKRSINK** Wringer Sink

**\$152.48** **HWPB** Water Button Kit



### WALL MOUNT STAINLESS STEEL SINK FOR HANDWRINGERS

DRALCO

- 8" H x 17¾" W x 16¼" D
- Handwringer NOT INCLUDED

**\$294.99** **HWSINK**

# BAY ACCESSORIES

## KLEEN-RITE GUN & BRUSH KITS



### LOW PRESSURE FOAM BRUSH BUNDLE

#### KLEEN-RITE KITS

• An essential kit with all the components needed for your foamy brushes. This kit is very cost-efficient for quick repairs or setting up a brand new foam brush station at your car wash.

#### KIT INCLUDES:

- (1) 711A40MFV Blue X-tra Heavy Duty Coated Aluminum Foamy Handle
- (1) KRKV1102-BL Hog Daddy Hogs Hair Brush Blue - 4"
- (1) HA156FBL1443 Blue Foamy Hose -  $\frac{3}{8}$ " MPE,  $\frac{3}{8}$ " MSE, 15'
- (1) 5055 (SWV-1000) Economy Low Pressure Swivel  $\frac{3}{8}$ " M x F

**\$85.32** KRK2070



### HIGH PRESSURE WEEP GUN/HOSE ASSEMBLY KIT

#### KLEEN-RITE KITS

• Get the essential parts for weep guns at your facility all in a convenient assembly kit! Includes all the parts you need to get your weep gun started.

#### KIT INCLUDES:

- (1) GUK600W Weep Gun with Blue Trigger
- (1) HA156WBL1414 Blue Single Wirebraided Hose  $\frac{3}{8}$ " MPE
- (1) 22002 GinSan Blue Nozzle Protector  $\frac{1}{4}$ "
- (1) 2506 Spraying Systems Stainless Steel Spray Nozzle  $\frac{1}{8}$ "
- (1) SW-504A Fluid Controls Brass Ball Bearing Swivel  $\frac{3}{8}$ " F x M
- (1) 291G18MF Blue Rubber Flex Wand  $\frac{1}{4}$ " M x  $\frac{1}{8}$ " F, 18"

**\$94.87** KRK2080



### HIGH PRESSURE COMFORT WEEP GUN ASSEMBLY KIT

#### KLEEN-RITE KITS

• Provides smooth operation in high-pressure spraying applications. Ready for use in self-serve bays with the addition of a spray nozzle of your choice (sold separately). Customers can enjoy consistent and comfortable spraying and rinsing. This is a weep style spray gun that keeps water moving through the gun to avoid freezing.

#### KIT INCLUDES:

- (1) GUK600W High-Pressure Weep Gun
- (1) WTL22003 18" Insulated Lance
- (1) WTS418 18" x  $\frac{1}{4}$ " Stainless Steel Wand
- (1) NPGSBK  $\frac{1}{4}$ " Nozzle Protector
- (1) GUG22046 Black Rubber Gun Guard
- (1) WTL22004 Handle Snap Clip

#### GUK600W GUN SPECIFICATIONS:

- **MAX. PSI:** 4000
- **FLOW:** 10.5 GPM
- **INLET:**  $\frac{3}{8}$ "
- **OUTLET:**  $\frac{1}{4}$ "
- **MAX. TEMP:** 300°F

**NOZZLE NOT INCLUDED**

**\$56.28** GUK600W-C

## SPRAY GUN ASSEMBLIES



**GUN**



**LANCE/WAND**

**NOZZLE PROTECTOR**

**NOZZLE**

A typical gun assembly includes a gun, wand (or lance), nozzle protector and nozzle.

# BAY ACCESSORIES

## SPRAY GUNS



### KLEEN-RITE GUNS

SPRAY GUNS

**KLEEN-RITE**.corp

- Interchange with CAT 32121 gun parts
- **MAX FLOW:** 10.5 GPM
- **MAX PRESSURE:** 4000PSI
- **MAX TEMP.:** 300° F.
- **INLET:** 3/8" FPT
- **OUTLET:** 1/4" FPT

|                |                 |          |
|----------------|-----------------|----------|
| <b>\$28.01</b> | <b>GUK600W</b>  | Weep     |
| <b>\$28.01</b> | <b>GUK600NW</b> | Non Weep |

### REPLACEMENT KITS FOR KLEEN-RITE GUNS

SPRAY GUN REPAIR PARTS

|                |                   |   |                |                 |                              |
|----------------|-------------------|---|----------------|-----------------|------------------------------|
| <b>\$13.75</b> | <b>GUK600KW</b>   | WEEP (For guns manufactured up to 2007)     | <b>\$12.37</b> | <b>GUK600H</b>  | Non Weep Housing with screws |
| <b>\$15.61</b> | <b>GUK600KW-N</b> | WEEP (For guns manufactured 2007 and after) | <b>\$12.37</b> | <b>GUK600HW</b> | WEEP Housing with screws     |
| <b>\$13.14</b> | <b>GUK600K</b>    | Repair Kit for GU600NW Non-Weep Gun         |                |                 |                              |



### GIANT GUNS

SPRAY GUNS



- **MAX FLOW:** 10 GPM
- **MAX PSI:** 5000 PSI
- **MAX TEMP.:** 300° F.
- **REAR INLET:** 3/8" FPT
- **OUTLET:** 1/4" FPT

### STAINLESS STEEL

GIANT SPRAY GUNS

### BRASS

GIANT SPRAY GUNS

|                |                |                                |                |                |   |
|----------------|----------------|--------------------------------|----------------|----------------|---|
| <b>\$28.87</b> | <b>PU21250</b> | Non-Weep - Sta Outlet          | <b>\$20.17</b> | <b>PU21290</b> | Non-Weep                                      |
| <b>\$28.87</b> | <b>PU21255</b> | Weep - SS Outlet               | <b>\$20.17</b> | <b>PU21295</b> | Weep  |
| <b>\$25.95</b> | <b>PU21260</b> | Non-weep with recessed fitting | <b>\$24.11</b> | <b>PU21495</b> | Weep - Stronger Material - Withstands Impacts |
| <b>\$25.95</b> | <b>PU21265</b> | Weep with recessed fitting     |                |                |   |

### REPLACEMENT KITS FOR GIANT GUNS

GIANT SPRAY GUNS

|               |                |          |
|---------------|----------------|----------|
| <b>\$5.59</b> | <b>PU21240</b> | Weep     |
| <b>\$4.99</b> | <b>PU21227</b> | Non-Weep |



### STRAIGHT GRIP SPRAY GUN WITH HORIZONTAL FLOW THROUGH DESIGN

KLEEN-RITE

**KLEEN-RITE**.corp

- Easy pull trigger
- **MAX PSI:** 4000
- **MAX GPM:** 10.5
- **MAX TEMP.:** 300° F.
- **INLET:** 3/8" FPT
- **OUTLET:** 1/4" FPT

|                |                 |                 |
|----------------|-----------------|-----------------|
| <b>\$47.95</b> | <b>GUK700NW</b> | <b>NON-WEEP</b> |
|----------------|-----------------|-----------------|



### EASY PULL TRIGGER SPRAY GUN

KLEEN-RITE

**KLEEN-RITE**.corp

- Easy pull trigger
- **MAX PSI:** 4000
- **MAX GPM:** 10.5
- **MAX TEMP.:** 300° F.
- **INLET:** 3/8" FPT
- **OUTLET:** 1/4" FPT

|                |                |            |
|----------------|----------------|------------|
| <b>\$30.67</b> | <b>GUKEZW</b>  | WEEP       |
| <b>\$33.48</b> | <b>GUKEZNW</b> | NON-WEEP   |
| <b>\$17.21</b> | <b>GUKEZK</b>  | REPAIR KIT |



### ADJUSTABLE TRIGGER GUN

U. S. PARA PLATE



- UST Trigger Control - Light trigger pull
- Spring loaded positive shutoff
- Forged brass valve housing
- Stainless steel ball/rod with Viton seals
- **MAX GPM:** 10 GPM
- **MAX PSI:** 3000
- **MAX TEMP.:** 300° F.
- **INLET:** 3/8" FPT
- **OUTLET:** 1/4" FPT

|                |                |                         |
|----------------|----------------|-------------------------|
| <b>\$42.10</b> | <b>GUP106</b>  | WEEP                    |
| <b>\$14.80</b> | <b>GUP251</b>  | Nozzle for Weep Gun     |
| <b>\$51.15</b> | <b>GUP106N</b> | NON-WEEP                |
| <b>\$12.57</b> | <b>GUP250</b>  | Nozzle for Non-Weep Gun |
| <b>\$3.25</b>  | <b>GUP253</b>  | Seal Kit                |
| <b>\$24.86</b> | <b>GUP254</b>  | Rod Kit                 |



### CAT PUMPS® TRIGGER GUN

CAT PUMPS



- Durable Nylon body with new heat-resistant trigger and anti-fatigue design for longer life, less breakage
- Stainless Steel ball, seat
- **MAX FLOW:** 10.5GPM
- **MAX PSI:** 5000
- **MAX TEMP.:** 300° F.
- **INLET:** 3/8" FPT
- **OUTLET:** 1/4" FPT

|                |                |                          |
|----------------|----------------|--------------------------|
| <b>\$44.10</b> | <b>PU36141</b> | Weep                     |
| <b>\$44.10</b> | <b>PU36140</b> | Non-Weep                 |
| <b>\$22.50</b> | <b>PU36080</b> | Repair Kit for both guns |

**ANTI-FATIGUE DESIGN**

# BAY ACCESSORIES

## SPRAY GUNS



### MV925 EASY PULL TRIGGER SPRAY GUN

MECLINE

- MAX FLOW: 8.0 GPM
- MAX PRESSURE: 4500 PSI
- MAX TEMP.: 320° F.
- INLET: 3/8" FPT
- OUTLET: 1/4" FPT

|                |         |          |                  |
|----------------|---------|----------|------------------|
| <b>\$20.88</b> | MV925   | Non-Weep | <b>EASY PULL</b> |
| <b>\$18.96</b> | MV925-W | Weep     |                  |



### ECONOMY SPRAY GUN

J.E. ADAMS



- Rear Entry
- MATERIAL: Brass
- INLET: 3/8"
- MAX TEMP: 320°F
- MAX PSI: 4000
- OUTLET: 1/4"

|                |          |          |       |
|----------------|----------|----------|-------|
| <b>\$31.11</b> | GU6520NW | Non Weep | 8 GPM |
| <b>\$32.48</b> | GU6520W  | Weep     | 7 GPM |



### M407 SPRAY GUN

VELOCI PERFORMANCE PRODUCTS



- INLET: 3/8"
- MAX PSI: 4000
- OUTLET: 1/4"
- MAX GPM: 7.0

|                 |           |  |
|-----------------|-----------|--|
| <b>\$35.91</b>  | MTM100001 |  |
| <b>NON-WEEP</b> |           |  |



### SG35 EASY PULL SPRAY GUN

VELOCI PERFORMANCE PRODUCTS



- INLET: 3/8"
- MAX PSI: 5000
- OUTLET: 1/4"
- MAX GPM: 12.0

|                 |           |  |
|-----------------|-----------|--|
| <b>\$41.34</b>  | MTM100342 |  |
| <b>NON-WEEP</b> |           |  |



### SG35 ACID-RESISTANT EASY PULL SPRAY GUN

VELOCI PERFORMANCE PRODUCTS



- INLET: 3/8"
- MAX PSI: 5000
- OUTLET: 1/4"
- MAX GPM: 12.0

|                                  |           |  |
|----------------------------------|-----------|--|
| <b>\$38.22</b>                   | MTM100381 |  |
| <b>NON-WEEP • ACID RESISTANT</b> |           |  |



### SUT1100 LIGHT WEIGHT GUNS

SUTTNER®



- INLET: 3/8"
- MAX PSI: 3050
- OUTLET: 1/4"
- MAX GPM: 7.0

|                |            |                       |
|----------------|------------|-----------------------|
| <b>\$28.01</b> | SUT1100W   | Weep                  |
| <b>\$23.27</b> | SUT1100NW  | Non Weep              |
| <b>\$12.30</b> | SUT1100WK  | Repair Kit (Weep)     |
| <b>\$11.45</b> | SUT1100NWK | Repair Kit (Non-Weep) |

**NON-WEEP**



### SUT1500 SPRAY GUNS

SUTTNER



- INLET: 3/8"
- OUTLET: 1/4"

|                |           |                                |                |            |                       |
|----------------|-----------|--------------------------------|----------------|------------|-----------------------|
| <b>\$22.48</b> | SUT1500W  | Weep • 4000 PSI @ 12 GPM       | <b>\$17.57</b> | SUT1500WK  | Repair Kit (Weep)     |
| <b>\$22.57</b> | SUT1500NW | Non Weep • 5000 PSI @ 10.4 GPM | <b>\$9.38</b>  | SUT1500NWK | Repair Kit (Non Weep) |



### SUT1500 OPEN GUN

SUTTNER



- Perfect for Triple Foam applications!
- Ideal when unloader is unavailable
- INLET: 3/8" FPT
- MAX TEMP: 300° F
- OUTLET: 1/4" FPT
- MAX PSI: 4000 PSI

|                |          |
|----------------|----------|
| <b>\$15.23</b> | SUT1500H |
|----------------|----------|



### SUT2605 SPRAY GUN

SUTTNER



- INLET: 3/8" FMPT
- MAX PSI: 5000
- OUTLET: 1/4" FMPT
- MAX TEMP: 300° F
- MAX GPM: 12.0

|                |           |                             |
|----------------|-----------|-----------------------------|
| <b>\$36.91</b> | SUT2600NW | <b>RELAX ACTION TRIGGER</b> |
|----------------|-----------|-----------------------------|



### SUT810 SERIES GUNS

SUTTNER



- Inlet & discharge are both in the front of the gun, rather than through the gun body.
- INLET: 3/8"
- MAX PSI: 3050
- OUTLET: 1/4"
- MAX GPM: 8.0

|                |          |                   |
|----------------|----------|-------------------|
| <b>\$22.84</b> | SUT810W  | Weep              |
| <b>\$22.38</b> | SUT810NW | Non Weep          |
| <b>\$11.88</b> | SUT810K  | Repair Kit (Weep) |

**FRONT INLET**



### SUT2305 SERIES GUNS

SUTTNER



- MAX PSI: 4500 (Weep) & 5000 (Non Weep)
- INLET: 3/8"
- MAX GPM: 12.0
- OUTLET: 1/4"
- MAX TEMP: 300° F

|                |             |                            |
|----------------|-------------|----------------------------|
| <b>\$30.20</b> | SUT2300W    | Weep                       |
| <b>\$32.12</b> | SUT2300NW   | Non Weep                   |
| <b>\$49.26</b> | SUT2300NW-S | Non-Weep With Swivel Inlet |
| <b>\$12.14</b> | SUT2300KW   | Repair Kit                 |

**RELAX ACTION - EASY PULL**

CALIFORNIA PROPOSITION 65 NOTE: some items on this page may fall under the Proposition 65 act. Please consult the State of California Proposition 65 list ([oehha.ca.gov/proposition-65/proposition-65-list](http://oehha.ca.gov/proposition-65/proposition-65-list)) to learn more and to see a comprehensive list of Proposition 65 chemicals.

# BAY ACCESSORIES

## SPRAY GUNS



### SUT1200 SERIES BRASS WASH DOWN GUN

SUTTNER



- HOUSING: Forged brass
- INLET: 1/2" FNPT
- MAX. FLOW: 27 GPM
- MAX. PSI: 350
- MAX. TEMP.: 190° F.

**\$65.96** SUT1200



### SUT1200 SERIES STAINLESS STEEL WASH DOWN GUN

SUTTNER



- HOUSING: Stainless Steel
- INLET: 1/2" FNPT
- MAX. FLOW: 27 GPM
- MAX. PSI: 350
- MAX. TEMP.: 190° F.

**\$138.53** SUT1200SS



### SUT601 SERIES GUNS

SUTTNER



- A unique 15° angle designed for extended length lances for higher reach.
- INLET: 3/8"
- MAX PSI: 4000
- Repair kits available!
- OUTLET: 1/4"
- MAX GPM: 12.0

|                |           |            |
|----------------|-----------|------------|
| <b>\$30.23</b> | SUT601NW  | Non Weep   |
| <b>\$39.42</b> | SUT601W   | Weep       |
| <b>\$23.72</b> | SUT000054 | Repair Kit |



### AA70 SERIES GUNJET SPRAY GUNS

SPRAYING SYSTEMS CO

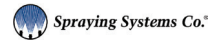

- Brass valve body, with stainless steel parts
- Bottom trigger pivot
- Inlet swivel eliminates hose twisting
- Viton O-rings
- MAX FLOW: 10 GPM
- OUTLET: 1/4" FPT
- MAX TEMP.: 300°F
- MAX PSI: 5000
- REAR INLET: 3/8" FPT

|                |           |          |
|----------------|-----------|----------|
| <b>\$40.17</b> | GUSSAA70  | Non Weep |
| <b>\$40.17</b> | GUSSAA70W | Weep     |



### 5030 SERIES SPRAY GUN

J.E. ADAMS SPRAY GUNS



- Brass valve body
- BRASS INLET: 3/8" FPT
- BRASS OUTLET: 1/4" FPT
- MAX TEMP.: 300° F.
- MAX PRESSURE: 4500 PSI
- MAX FLOW: 12 GPM
- BRASS INLET: 3/8" FPT

|                |           |            |
|----------------|-----------|------------|
| <b>\$33.41</b> | GU0114    | Weep       |
| <b>\$33.60</b> | GU0114-EW | Extra Weep |
| <b>\$33.19</b> | GU0115    | Non Weep   |

GU0115

### REPAIR KITS FOR 5030 SERIES

SPRAY GUN REPAIR PARTS

|                |            |                       |
|----------------|------------|-----------------------|
| <b>\$14.65</b> | GU0114K    | Weep Repair Kit       |
| <b>\$15.12</b> | GU0114K-EW | Extra Weep Repair Kit |
| <b>\$12.27</b> | GU0115K    | Non Weep Repair Kit   |



## LOOKING FOR MORE SPRAY GUNS?

Visit our website to request our Pressure Wash catalog for an even larger selection of quality products!

# BAY ACCESSORIES

## DUMP GUNS, FOAM GUNS & ACCESSORIES



### 12" BARREL STAINLESS STEEL DUMP GUN

KLEEN-RITE



• Dump guns are designed to allow low pressure spray while trigger is released and high pressure when trigger is pulled.

- **MAX FLOW:** 10 GPM
- **MAX PSI:** 3000 PSI
- **INLET:** 3/8" FPT
- **MAX TEMP.:** 140° F
- **LANCE HANDLE:** 12"
- **OUTLET:** 1/8" FPT

**\$90.31** GUKD85WL



### 15" BARREL DUMP GUN

CAT PUMPS



- Eliminates need for regulator or unloader valve
- **TOTAL LENGTH:** 25"
- **INLET:** 3/8" FPT
- **MAX FLOW:** 10 GPM
- **OUTLET:** 1/8" FPT
- **MAX TEMP.:** 140° F
- **PSI:** 3000

|                 |                |            |
|-----------------|----------------|------------|
| <b>\$107.50</b> | <b>PU32300</b> | Gun        |
| <b>\$27.50</b>  | <b>PU32763</b> | Repair Kit |



### FOAM GUNS & FOAM GUN PARTS

HAMEL MANUFACTURING CO.



#### STAINLESS STEEL RUBBER COATED

HAMEL MANUFACTURING CO.

|                |                |       |
|----------------|----------------|-------|
| <b>\$24.07</b> | <b>GUFBKSS</b> | Black |
| <b>\$24.07</b> | <b>GUFRSS</b>  | Red   |
| <b>\$24.07</b> | <b>GUFBSS</b>  | Blue  |

#### RUBBER COATED

HAMEL MANUFACTURING CO.

|                |              |       |
|----------------|--------------|-------|
| <b>\$18.14</b> | <b>GUFBK</b> | Black |
| <b>\$18.14</b> | <b>GUFRR</b> | Red   |
| <b>\$18.14</b> | <b>GUFBL</b> | Blue  |

#### NOZZLE PROTECTORS

HAMEL MANUFACTURING CO.

|               |               |       |
|---------------|---------------|-------|
| <b>\$2.36</b> | <b>NPHRBK</b> | Black |
| <b>\$2.36</b> | <b>NPHRR</b>  | Red   |
| <b>\$2.36</b> | <b>NPHRBL</b> | Blue  |

#### FOAM GUN NOZZLE

SPRAYING SYSTEMS CO.

**\$6.13** SN5040VVSS2

### TRIPLE FOAM HOSE WALL MOUNT HOLDER

BAY ACCESSORIES



- Stainless steel construction
- Attaches your triple foam hose to the wall
- For use with coil hose tubing on a triple foam system
- Eliminates the need for an extra ceiling boom

**\$36.00** TFWMHSS

### BREAKAWAY FITTINGS

FOR ALL GUNS



- Solid brass
- Save your guns from damage when hoses catch on vehicles
- Fitting will break before damage to gun or wand occurs

|               |               |      |
|---------------|---------------|------|
| <b>\$3.51</b> | <b>GU5068</b> | 1/4" |
| <b>\$4.91</b> | <b>GU5069</b> | 3/8" |

### GUN GUARD

SPRAY GUN PROTECTOR

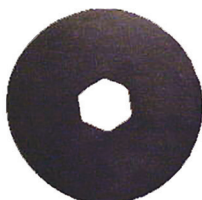

- Protect your guns from damage caused by repetitive insertion into the wand holder.

**\$6.50** GUG22046

### SPRAY GUN FITTINGS

VARIOUS MANUFACTURERS



| PRICE          | PART #          | DESCRIPTION                       | COMPANY |
|----------------|-----------------|-----------------------------------|---------|
| <b>\$12.57</b> | <b>GUP250</b>   | Non-Weep Discharge                |         |
| <b>\$14.80</b> | <b>GUP251</b>   | Weep Discharge                    |         |
| <b>\$5.52</b>  | <b>GU5091D1</b> | Inlet Fitting                     |         |
| <b>\$6.39</b>  | <b>GU5038</b>   | Discharge Fitting                 |         |
| <b>\$4.58</b>  | <b>PU21244</b>  | Inlet Fitting                     |         |
| <b>\$7.55</b>  | <b>PU21279</b>  | Brass Discharge Fitting           |         |
| <b>\$10.05</b> | <b>PU21256</b>  | Stainless Steel Discharge Fitting |         |
| <b>\$3.69</b>  | <b>PU77039</b>  | 1/4" Discharge Fitting            |         |
| <b>\$15.00</b> | <b>PU32006</b>  | 1/4" Discharge Fitting            |         |
| <b>\$23.03</b> | <b>GUK615</b>   | 3/8" Inlet Fitting                |         |
| <b>\$13.60</b> | <b>GUK620</b>   | 1/4" Outlet Fitting               |         |

# BAY ACCESSORIES

## NOZZLES/SPRAY TIPS

### GENERAL PUMP® SPRAY TIPS

GENERAL PUMP



- General Pump High Pressure Spray Tips are built using an innovative design and manufacturing approach that ensures accuracy and provides consistent durability and performance for all types of high pressure cleaning systems.
- View chart below to determine nozzle size

### HOW TO DETERMINE NOZZLE SIZE:

- 1 Calculate GPM & PSI to determine nozzle size  
(Ex. 1200 PSI at 3.8 GPM = nozzle size of 07)
- 2 After determining nozzle size, choose a degree of spray pattern:  
15 = 15° (narrow)  
25 = 25° (medium)  
40 = 40° (wide)  
Available spray patterns : 05, 15, 25, 40, 50, 65, 80
- 3 Degree of spray does not affect nozzle volume

$$\text{GPN} \_ \_ + \_ \_ + \text{M} \_$$

° of nozzle male  
spray size fitting size 2 = 1/8  
4 = 1/4



**ALL TIPS COME WITHOUT VEINS**  
**ALL MEGS ARE HARDENED STAINLESS STEEL**  
**FEMALE NOZZLES AVAILABLE**

#### SOME OF THE MORE POPULAR SIZES INCLUDE:

| 15°     | 25°     | 40°     |
|---------|---------|---------|
| GPN1505 | GPN2505 | GPN4005 |
| GPN1506 | GPN2506 | GPN4006 |
| GPN1507 | GPN2507 | GPN4007 |
| GPN1508 | GPN2508 |         |

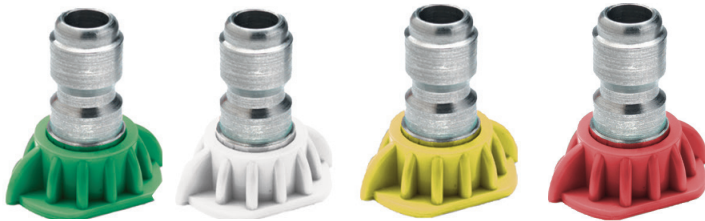

### QUICK CONNECT SPRAY TIPS

GENERAL PUMP



- Color-coded high pressure sprayer tips
- 5000 PSI operating pressure
- Through-hardened stainless steel orifices
- Resists cracking & wear, Color coded tip protector
  - Red - 0°
  - Yellow - 15°
  - Green - 25°
  - White - 40°

#### PART # FORMULA

$$\text{QC} \_ \_ + \_ \_$$

° of nozzle  
spray size

### INTERIOR #S ARE GPM

| NOZZLE SIZE | ORIFICE DIAM. (INCHES) | 40 PSI | 100 PSI | 250 PSI | 500 PSI | 600 PSI | 700 PSI | 800 PSI | 1000 PSI | 1200 PSI * | 1500 PSI | 2000 PSI | 2500 PSI | 3000 PSI | 3500 PSI | 4000 PSI |
|-------------|------------------------|--------|---------|---------|---------|---------|---------|---------|----------|------------|----------|----------|----------|----------|----------|----------|
| 2           | .034                   | .20    | .32     | .50     | .71     | .77     | .80     | .89     | 1.0      | 1.1        | 1.2      | 1.4      | 1.6      | 1.7      | 1.9      | 2.0      |
| 4           | .052                   | .40    | .63     | 1.00    | 1.40    | 1.60    | 1.70    | 1.80    | 2.0      | 2.2        | 2.5      | 2.8      | 3.1      | 3.5      | 3.8      | 4.0      |
| 4.5         | .055                   | .45    | .71     | 1.10    | 1.50    | 1.70    | 1.90    | 2.00    | 2.2      | 2.4        | 2.8      | 3.0      | 3.6      | 3.9      | 4.3      | 4.5      |
| 5           | .057                   | .50    | .79     | 1.30    | 1.80    | 1.90    | 2.10    | 2.20    | 2.5      | 2.8        | 3.1      | 3.6      | 4.0      | 4.4      | 4.7      | 5.0      |
| 5.5         | .060                   | .55    | .87     | 1.40    | 1.90    | 2.10    | 2.30    | 2.50    | 2.8      | 3.0        | 3.4      | 3.8      | 4.4      | 4.8      | 5.2      | 5.5      |
| 6           | .062                   | .60    | .95     | 1.50    | 2.10    | 2.30    | 2.50    | 2.70    | 3.0      | 3.2        | 3.7      | 4.2      | 4.8      | 5.2      | 5.6      | 6.0      |
| 6.5         | .064                   | .65    | 1.00    | 1.70    | 2.30    | 2.50    | 2.70    | 2.90    | 3.3      | 3.6        | 4.0      | 4.6      | 5.2      | 5.7      | 6.0      | 6.5      |
| 7 *         | .067                   | .70    | 1.10    | 1.80    | 2.50    | 2.70    | 2.90    | 3.10    | 3.5      | 3.8*       | 4.3      | 5.0      | 5.6      | 6.1      | 6.6      | 7.0      |
| 7.5         | .070                   | .75    | 1.20    | 1.90    | 2.70    | 2.90    | 3.20    | 3.40    | 3.8      | 4.1        | 4.6      | 5.3      | 6.0      | 6.5      | 7.0      | 7.5      |
| 8           | .072                   | .80    | 1.30    | 2.00    | 2.80    | 3.10    | 3.40    | 3.60    | 4.0      | 4.4        | 5.0      | 5.6      | 6.2      | 7.0      | 7.5      | 8.0      |
| 8.5         | .074                   | .85    | 1.30    | 2.20    | 3.00    | 3.30    | 3.60    | 3.80    | 4.3      | 4.6        | 5.3      | 6.0      | 6.7      | 7.4      | 8.0      | 8.5      |
| 9           | .076                   | .90    | 1.40    | 2.30    | 3.20    | 3.50    | 3.80    | 4.00    | 4.8      | 5.0        | 5.5      | 6.4      | 7.1      | 7.8      | 8.5      | 9.0      |
| 9.5         | .078                   | .95    | 1.50    | 2.40    | 3.40    | 3.70    | 4.00    | 4.30    | 4.8      | 5.2        | 5.8      | 6.8      | 7.6      | 8.3      | 9.0      | 9.5      |
| 10          | .080                   | 1.00   | 1.60    | 2.50    | 3.50    | 3.90    | 4.20    | 4.50    | 5.0      | 5.4        | 6.1      | 7.0      | 8.0      | 8.7      | 9.4      | 10.0     |



### AUTOMATIC NOZZLE REPLACEMENT KITS

GENERAL PUMPS

- Nozzle replacement kits for popular brand automatic car washes

|                |                  |                 |
|----------------|------------------|-----------------|
| <b>\$62.44</b> | <b>GPN105140</b> | PDQ Laser 4000  |
| <b>\$60.23</b> | <b>GPN105144</b> | D&S 5000 Gantry |

|                |                  |                  |
|----------------|------------------|------------------|
| <b>\$47.23</b> | <b>GPN105145</b> | D&S 5000 Blaster |
| <b>\$90.97</b> | <b>GPN105154</b> | SSA Futura       |



### DRAIN CLEANING NOZZLES

GENERAL PUMPS



- Self-propelled drain cleaning nozzle lets you unclog drain lines inexpensively. Hook up to high pressure hose to blast through clogs.

|                |                  |                           |
|----------------|------------------|---------------------------|
| <b>\$16.40</b> | <b>GPNYDRNT1</b> | 1/4" Male Brass           |
| <b>\$24.82</b> | <b>GPNYDRNT2</b> | 1/4" Male Stainless Steel |
| <b>\$33.73</b> | <b>GPNYDRNT3</b> | 3/8" Male Stainless Steel |



### TIP TWISTER®

HAMEL MANUFACTURING CO.



|               |               |                                |
|---------------|---------------|--------------------------------|
| <b>\$8.56</b> | <b>SNTTM4</b> | 5/8 Twister - Fits 1/4" Nozzle |
| <b>\$9.92</b> | <b>SNTTM2</b> | 1/2 Twister - Fits 1/8" Nozzle |

ALL PRICES ARE F.O.B. AND ARE SUBJECT TO CHANGE WITHOUT NOTICE • NO C.O.D.'S

1-800-233-3873 • (717) 684-6721 • FAX (800) 446-0495 • KLEENRITE.COM

375

# BAY ACCESSORIES

## SPRAY NOZZLES



FIND YOUR  
SPRAY TIP  
NUMBER HERE!

### WASHJET® MEG SPRAY NOZZLES SPRAYING SYSTEMS CO.



- Spray angles of 0° to 65°
- Uniform distribution – an internal guide vane stabilizes liquid turbulence
- Longer wear life and flow control accuracy with specially hardened stainless steel
- Female nozzles and VeeJet® nozzles are available

|               |                 |               |
|---------------|-----------------|---------------|
| <b>\$4.37</b> | <b>SN6502M4</b> | 1/4"          |
| <b>\$4.17</b> | <b>SN1515M2</b> | 1/8" Male NPT |

### HOW TO DETERMINE NOZZLE SIZE:

- Calculate GPM & PSI to determine nozzle size (Ex. 1200 PSI at 3.8 GPM = nozzle size of 07 See \* below)
- After determining nozzle size, choose a degree of spray pattern:
  - 15 = 15° (narrow)
  - 25 = 25° (medium)
  - 40 = 40° (wide)
- Available spray patterns : 05, 15, 25, 40, 50, 65, 80
- Degree of spray does not affect nozzle volume



### THE PERFECT CAR WASH NOZZLE SPRAY NOZZLES

- 32° Available in these sizes only!!

|               |                 |
|---------------|-----------------|
| <b>\$4.17</b> | <b>SN3205M2</b> |
| <b>\$4.17</b> | <b>SN3206M2</b> |
| <b>\$4.17</b> | <b>SN3207M2</b> |

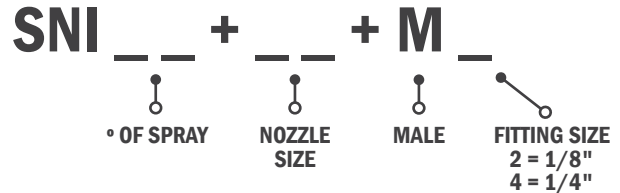

### INTERIOR #S ARE GPM

| NOZZLE SIZE | ORIFICE DIAM. (INCHES) | 40 PSI | 100 PSI | 250 PSI | 500 PSI | 600 PSI | 700 PSI | 800 PSI | 1000 PSI | 1200 PSI * | 1500 PSI | 2000 PSI | 2500 PSI | 3000 PSI | 3500 PSI | 4000 PSI |
|-------------|------------------------|--------|---------|---------|---------|---------|---------|---------|----------|------------|----------|----------|----------|----------|----------|----------|
| 2           | .034                   | .20    | .32     | .50     | .71     | .77     | .80     | .89     | 1.0      | 1.1        | 1.2      | 1.4      | 1.6      | 1.7      | 1.9      | 2.0      |
| 4           | .052                   | .40    | .63     | 1.00    | 1.40    | 1.60    | 1.70    | 1.80    | 2.0      | 2.2        | 2.4      | 2.8      | 3.2      | 3.5      | 3.8      | 4.0      |
| 4.5         | .055                   | .45    | .71     | 1.10    | 1.60    | 1.70    | 1.90    | 2.00    | 2.3      | 2.4        | 2.8      | 3.2      | 3.6      | 3.9      | 4.3      | 4.5      |
| 5           | .057                   | .50    | .79     | 1.30    | 1.80    | 1.90    | 2.10    | 2.20    | 2.5      | 2.8        | 3.1      | 3.5      | 4.0      | 4.3      | 4.7      | 5.0      |
| 5.5         | .060                   | .55    | .87     | 1.40    | 1.90    | 2.10    | 2.30    | 2.50    | 2.8      | 3.0        | 3.4      | 3.9      | 4.3      | 4.8      | 5.2      | 5.5      |
| 6           | .062                   | .60    | .95     | 1.50    | 2.10    | 2.30    | 2.50    | 2.70    | 3.0      | 3.2        | 3.7      | 4.2      | 4.7      | 5.2      | 5.6      | 6.0      |
| 6.5         | .064                   | .65    | 1.00    | 1.70    | 2.30    | 2.50    | 2.70    | 2.90    | 3.3      | 3.6        | 4.0      | 4.6      | 5.1      | 5.6      | 6.0      | 6.5      |
| 7 *         | .067                   | .70    | 1.10    | 1.80    | 2.50    | 2.70    | 2.90    | 3.10    | 3.5      | 3.8*       | 4.3      | 4.9      | 5.6      | 6.1      | 6.6      | 7.0      |
| 7.5         | .070                   | .75    | 1.20    | 1.90    | 2.70    | 2.90    | 3.20    | 3.40    | 3.8      | 4.1        | 4.6      | 5.3      | 5.9      | 6.5      | 7.0      | 7.5      |
| 8           | .072                   | .80    | 1.30    | 2.00    | 2.80    | 3.10    | 3.40    | 3.60    | 4.0      | 4.4        | 4.9      | 5.7      | 6.3      | 6.9      | 7.5      | 8.0      |
| 8.5         | .074                   | .85    | 1.30    | 2.20    | 3.00    | 3.30    | 3.60    | 3.80    | 4.3      | 4.6        | 5.2      | 6.0      | 6.7      | 7.4      | 8.0      | 8.5      |
| 9           | .076                   | .90    | 1.40    | 2.30    | 3.20    | 3.50    | 3.80    | 4.00    | 4.5      | 5.0        | 5.5      | 6.4      | 7.1      | 7.8      | 8.5      | 9.0      |
| 9.5         | .078                   | .95    | 1.50    | 2.40    | 3.40    | 3.70    | 4.00    | 4.30    | 4.8      | 5.2        | 5.8      | 6.7      | 7.5      | 8.2      | 9.0      | 9.5      |
| 10          | .080                   | 1.00   | 1.60    | 2.50    | 3.50    | 3.90    | 4.20    | 4.50    | 5.0      | 5.4        | 6.1      | 7.1      | 7.9      | 8.7      | 9.4      | 10.0     |



### WASHJET® IMEG® SPRAY NOZZLES SPRAYING SYSTEMS CO.



- Patented design provides optimized fluid dynamics to minimize turbulence and maximize spray performance
- The 302 stainless steel guide vane further stabilizes turbulent flow and improves pattern quality and cleaning efficiency
- Spray angles of 0° to 65°
- Uniform distribution – an internal guide vane stabilizes liquid turbulence
- Longer wear life and flow control accuracy with specially hardened stainless steel
- Please reference nozzle # chart above for help!



# BAY ACCESSORIES

## NOZZLES/SPRAY TIPS

SPRAYING SYSTEMS CO.® STAINLESS & KYNAR® TIPS  
SPRAYING SYSTEMS CO

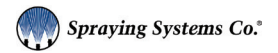

| PRICE  | KR PART #   | SPRAYING SYSTEMS # | MATERIAL        | ANGLE | NOZZLE # | GPM @40 PSI |
|--------|-------------|--------------------|-----------------|-------|----------|-------------|
| \$7.31 | SN0004USS4  | H1/4U-SS0004       | Stainless Steel | 0°    | 04       | .40         |
| \$7.31 | SN0005USS4  | H1/4U-SS0005       |                 |       | 05       | .50         |
| \$6.80 | SN1502VVSS4 | H1/4VV-SS1502      |                 | 15°   | 02       | .20         |
| \$7.31 | SN1510USS4  | H1/4U-SS1510       |                 |       | 10       | 1.02        |
| \$7.28 | SN1515USS4  | H1/4U-SS1515       |                 |       | 15       | 1.54        |
| \$7.28 | SN1520USS4  | H1/4U-SS1520       |                 |       | 20       | 2           |
| \$7.28 | SN1530USS4  | H1/4U-SS1530       |                 |       | 30       | 3           |
| \$6.80 | SN1503VVSS4 | H1/4VV-SS1503      |                 |       | 03       | .30         |
| \$6.80 | SN1505VVSS4 | H1/4VV-SS1505      |                 |       | 05       | .50         |
| \$6.80 | SN1506VVSS4 | H1/4VV-SS1506      |                 |       | 06       | .60         |
| \$6.80 | SN1508VVSS4 | H1/4VV-SS1508      |                 |       | 08       | .80         |
| \$6.80 | SN2505VVSS4 | H1/4VV-SS2505      |                 |       | 25°      | 05          |



|        |             |                |             |     |    |      |
|--------|-------------|----------------|-------------|-----|----|------|
| \$2.32 | SNCCP2501M4 | H1/4VV-CKY2501 | Kynar/Green | 25° | 01 | .10  |
| \$2.32 | SNCCP2502M4 | H1/4VV-CKY2502 |             |     | 02 | .20  |
| \$2.32 | SNCCP2503M4 | H1/4VV-CKY2503 |             |     | 03 | .30  |
| \$2.32 | SNCCP2504M4 | H1/4VV-CKY2504 |             |     | 04 | .40  |
| \$2.32 | SNCCP2506M4 | H1/4VV-CKY2506 |             |     | 06 | .60  |
| \$2.32 | SNCCP2506M4 | H1/4VV-CKY2508 |             |     | 08 | .80  |
| \$2.32 | SNCCP2510M4 | H1/4VV-CKY2510 |             |     | 10 | 1    |
| \$2.33 | SN2515CKY4  | H1/4U-CKY2515  |             |     | 15 | 1.50 |
| \$2.33 | SN2520CKY4  | H1/4U-CKY2520  |             |     | 20 | 2    |
| \$2.25 | SN2530CKY4  | H1/4U-CKY2530  |             |     | 30 | 3    |



|        |             |                |             |     |    |      |
|--------|-------------|----------------|-------------|-----|----|------|
| \$2.32 | SNCCP4002M4 | H1/4VV-CKY4002 | Kynar/White | 40° | 02 | .20  |
| \$2.32 | SNCCP4003M4 | H1/4VV-CKY4003 |             |     | 03 | .30  |
| \$2.32 | SNCCP4004M4 | H1/4VV-CKY4004 |             |     | 04 | .40  |
| \$2.32 | SNCCP4005M4 | H1/4VV-CKY4005 |             |     | 05 | .50  |
| \$2.32 | SNCCP4006M4 | H1/4VV-CKY4006 |             |     | 06 | .60  |
| \$2.32 | SNCCP4008M4 | H1/4VV-CKY4008 |             |     | 08 | .80  |
| \$2.32 | SNCCP4010M4 | H1/4VV-CKY4010 |             |     | 10 | 1    |
| \$2.33 | SN4015CKY4  | H1/4U-CKY4015  |             |     | 15 | 1.50 |
| \$2.33 | SN4020CKY4  | H1/4U-CKY4020  |             |     | 20 | 2    |
| \$2.33 | SN4030CKY4  | H1/4U-CKY4030  |             |     | 30 | 3    |



|        |             |                |              |     |    |      |
|--------|-------------|----------------|--------------|-----|----|------|
| \$2.32 | SNCCP6501M4 | H1/4VV-CKY6501 | Kynar/Purple | 65° | 01 | .10  |
| \$2.32 | SNCCP6502M4 | H1/4VV-CKY6502 |              |     | 02 | .20  |
| \$2.32 | SNCCP6503M4 | H1/4VV-CKY6503 |              |     | 03 | .30  |
| \$2.32 | SNCCP6504M4 | H1/4VV-CKY6504 |              |     | 04 | .40  |
| \$2.32 | SNCCP6505M4 | H1/4VV-CKY6505 |              |     | 05 | .50  |
| \$2.32 | SNCCP6506M4 | H1/4VV-CKY6506 |              |     | 06 | .60  |
| \$2.32 | SNCCP6508M4 | H1/4VV-CKY6508 |              |     | 08 | .80  |
| \$2.32 | SNCCP6510M4 | H1/4VV-CKY6510 |              |     | 10 | 1    |
| \$2.33 | SN6515CKY4  | H1/4U-CKY6515  |              |     | 15 | 1.50 |
| \$2.33 | SN6520CKY4  | H1/4U-CKY6520  |              |     | 20 | 2    |
| \$2.33 | SN6530CKY4  | H1/4U-CKY6530  |              |     | 30 | 3    |
| \$2.33 | SN6550CKY4  | H1/4U-CKY6550  |              |     | 50 | 5    |



|        |             |                |                   |     |    |      |
|--------|-------------|----------------|-------------------|-----|----|------|
| \$2.32 | SNCCP8001M4 | H1/4VV-CKY8001 | Kynar/Light Green | 80° | 01 | .10  |
| \$2.32 | SNCCP8002M4 | H1/4VV-CKY8002 |                   |     | 02 | .20  |
| \$2.32 | SNCCP8003M4 | H1/4VV-CKY8003 |                   |     | 03 | .30  |
| \$2.32 | SNCCP8004M4 | H1/4VV-CKY8004 |                   |     | 04 | .40  |
| \$2.32 | SNCCP8005M4 | H1/4VV-CKY8005 |                   |     | 05 | .50  |
| \$2.32 | SNCCP8006M4 | H1/4VV-CKY8006 |                   |     | 06 | .60  |
| \$2.32 | SNCCP8008M4 | H1/4VV-CKY8008 |                   |     | 08 | .80  |
| \$2.32 | SNCCP8010M4 | H1/4VV-CKY8010 |                   |     | 10 | 1    |
| \$2.33 | SN8015CKY4  | H1/4U-CKY8015  |                   |     | 15 | 1.50 |
| \$2.33 | SN8020CKY4  | H1/4U-CKY8020  |                   |     | 20 | 2    |
| \$2.33 | SN8030CKY4  | H1/4U-CKY8030  |                   |     | 30 | 3    |

# BAY ACCESSORIES

## NOZZLES/SPRAY TIPS



### FLOODJET® WIDE ANGLE FLAT SPRAY TIP

SPRAYING SYSTEMS CO.

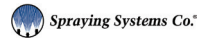

| PRICE  | PART #  | ORIFICE | COLOR | PRICE  | PART #    | ORIFICE | COLOR |
|--------|---------|---------|-------|--------|-----------|---------|-------|
| \$0.99 | SNTKVP3 | 3.0     | Gray  | \$0.98 | SNTKVP7.5 | 7.5     | Green |
| \$0.99 | SNTKVP4 | 4.0     | White | \$0.99 | SNTKVP10  | 10.0    | Black |
| \$0.99 | SNTKVP5 | 5.0     | Blue  |        |           |         |       |

### FLOODJET® SPRAY TIPS

SPRAYING SYSTEMS CO.

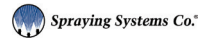

| STAINLESS STEEL |              |                           |
|-----------------|--------------|---------------------------|
| \$10.62         | SNFJ02K18SS  | 1/8" FLOODJET #18 NOZZLE  |
| \$10.62         | SNFJ02K7.5SS | 1/8" FLOODJET #7.5 NOZZLE |
| \$12.85         | SNFJ04K10SS  | 1/4" FLOODJET #10 NOZZLE  |
| \$12.85         | SNFJ04K15SS  | 1/4" FLOODJET #15 NOZZLE  |
| \$12.85         | SNFJ04SS2    | 1/4" FLOODJET #2 NOZZLE   |
| \$12.85         | SNFJ04SS3    | 1/4" FLOODJET #3 NOZZLE   |
| \$12.85         | SNFJ04SS5    | 1/4" FLOODJET #5 NOZZLE   |
| \$12.85         | SNFJ04SS75   | 1/4" FLOODJET #7.5 NOZZLE |

| BRASS  |            |                           |
|--------|------------|---------------------------|
| \$3.61 | SNFJ02K3   | 1/8" FLOODJET #3 NOZZLE   |
| \$3.61 | SNFJ02K7.5 | 1/8" FLOODJET #7.5 NOZZLE |
| \$5.70 | SNFJ045    | 1/4" FLOODJET #5 NOZZLE   |
| \$5.70 | SNFJ0475   | 1/4" FLOODJET #7.5 NOZZLE |
| \$5.70 | SNFJ04K10  | 1/4" FLOODJET #10 NOZZLE  |
| \$5.70 | SNFJ04K15  | 1/4" FLOODJET #15 NOZZLE  |
| \$5.70 | SNFJ04K3   | 1/4" FLOODJET #3 NOZZLE   |

| PVC     |              |                           |
|---------|--------------|---------------------------|
| \$16.09 | SNFJ04K15PVC | 1/4" FLOODJET #15 NOZZLE  |
| \$16.09 | SNFJ04K27PVC | 1/4" FLOODJET #27 NOZZLE  |
| \$16.09 | SNFJ04K75PVC | 1/4" FLOODJET #7.5 NOZZLE |

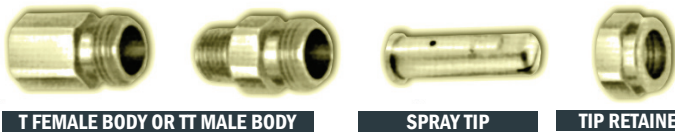

### FOAMJET® NOZZLES

SPRAYING SYSTEMS CO.

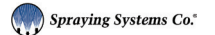

- Produces low pressure foam when used with detergent

### PLASTIC FOAMJET® NOZZLES

SPRAYING SYSTEMS CO.

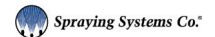

- Plastic spray tips are constructed of lightweight, chemically inserted polypropylene and feature color-coded orifice inserts.



\*COLOR CODED NOZZLE ORIFICES ON PLASTIC NOZZLES ONLY!

● 02 ● 03 ● 04 ● 05

| PRICE   | PART #      | BODY    | DEGREE | ORIFICE | PRICE   | PART #      | BODY    | DEGREE | ORIFICE |
|---------|-------------|---------|--------|---------|---------|-------------|---------|--------|---------|
| \$21.63 | SNFJP2002CE | Plastic | 20     | 02      | \$21.63 | SNFJP6503CE | Plastic | 65     | 03      |
| \$21.63 | SNFJP2003CE | Plastic | 20     | 03      | \$21.63 | SNFJP6505CE | Plastic | 65     | 05      |
| \$21.63 | SNFJP2004CE | Plastic | 20     | 04      | \$20.42 | SNFJP6508CE | Plastic | 65     | 08      |
| \$21.63 | SNFJP2005CE | Plastic | 20     | 05      | \$21.63 | SNFJP8003CE | Plastic | 80     | 03      |
| \$21.63 | SNFJP4002CE | Plastic | 40     | 02      | \$21.63 | SNFJP8004CE | Plastic | 80     | 04      |
| \$21.63 | SNFJP4004CE | Plastic | 40     | 04      | \$21.63 | SNFJP8005CE | Plastic | 80     | 05      |
| \$19.81 | SNFJP4005CE | Plastic | 40     | 05      |         |             |         |        |         |



### BRASS FOAMJET® NOZZLES

SPRAYING SYSTEMS CO.

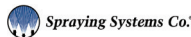

| PRICE   | PART #   | BODY  | PATTERN | ORIFICE |
|---------|----------|-------|---------|---------|
| \$35.28 | SNFJ4003 | Brass | 40      | 03      |
| \$35.28 | SNFJ8003 | Brass | 80      | 03      |
| \$35.28 | SNFJ8005 | Brass | 80      | 05      |



### STAINLESS STEEL MEF FOAMJET® NOZZLES

1/4" MALE THREADED END

SPRAYING SYSTEMS CO.

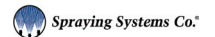

| PRICE   | PART #      | BODY | PATTERN | ORIFICE |
|---------|-------------|------|---------|---------|
| \$55.72 | SNFJ4005SS4 | SS   | 40      | 05      |
| \$55.72 | SNFJ4006SS4 | SS   | 40      | 06      |
| \$55.72 | SNFJ4007SS4 | SS   | 40      | 07      |
| \$55.72 | SNFJ4008SS4 | SS   | 40      | 08      |
| \$55.72 | SNFJ4010SS4 | SS   | 40      | 10      |



### QUICKJET® FOAMJET®

SPRAYING SYSTEMS CO.

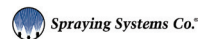

- QJFP offers easy installation and maintenance with quarter-turn automatic alignment
- Offers a complete array of spray patterns and angles
- Plastic spray tips are constructed of lightweight, chemically inserted CELCON® and feature color-coded orifice inserts

| PRICE   | PART #     | BODY    | DEGREE | ORIFICE | PRICE   | PART #     | BODY    | DEGREE | ORIFICE |
|---------|------------|---------|--------|---------|---------|------------|---------|--------|---------|
| \$17.66 | SNQJFP4002 | Plastic | 40     | 02      | \$17.66 | SNQJFP8003 | Plastic | 80     | 03      |
| \$17.66 | SNQJFP4005 | Plastic | 40     | 05      | \$17.66 | SNQJFP8004 | Plastic | 80     | 04      |
| \$17.66 | SNQJFP8002 | Plastic | 80     | 02      | \$17.66 | SNQJFP8008 | Plastic | 80     | 08      |

# BAY ACCESSORIES

## NOZZLES/SPRAY TIPS & STRAINERS



**Spraying Systems Co.®**

### UNIJET® ASSEMBLY

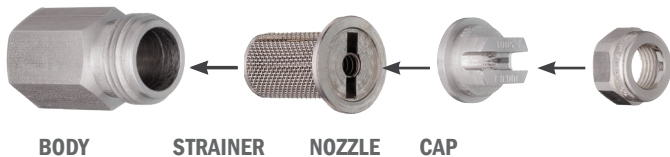

BODY STRAINER NOZZLE CAP

### UNIJET® FLAT FAN SPRAY NOZZLES

SPRAYING SYSTEMS CO.®

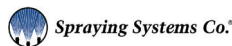

- For Rinse or Soap arches. Designed to be used with the bodies, caps and strainers shown on this page.
- OTHER SIZES AVAILABLE



| PART #        | MATERIAL | ORIFICE | PATTERN |
|---------------|----------|---------|---------|
| SNTP1504      | Brass    | 4       | 15°     |
| SNTP1506      | Brass    | 6       | 15°     |
| SNTP1508      | Brass    | 8       | 15°     |
| SNTP2504      | Brass    | 4       | 25°     |
| SNTP2506      | Brass    | 6       | 25°     |
| SNTP2509      | Brass    | 9       | 25°     |
| SNTP4003      | Brass    | 3       | 40°     |
| SNTP4004      | Brass    | 4       | 40°     |
| SNTP4005      | Brass    | 5       | 40°     |
| SNTP4006      | Brass    | 6       | 40°     |
| SNTP4008      | Brass    | 8       | 40°     |
| SNTP4010      | Brass    | 10      | 40°     |
| SNTP4020      | Brass    | 20      | 40°     |
| <b>\$2.65</b> |          |         |         |



| PART #        | MATERIAL  | ORIFICE | PATTERN |
|---------------|-----------|---------|---------|
| SNTP1504SS    | Stainless | 4       | 15°     |
| SNTP1506SS    | Stainless | 6       | 15°     |
| SNTP1508SS    | Stainless | 8       | 15°     |
| SNTP2504SS    | Stainless | 4       | 25°     |
| SNTP2506SS    | Stainless | 6       | 25°     |
| SNTP2508SS    | Stainless | 8       | 25°     |
| SNTP4003SS    | Stainless | 3       | 40°     |
| SNTP4004SS    | Stainless | 4       | 40°     |
| SNTP4006SS    | Stainless | 6       | 40°     |
| SNTP4007SS    | Stainless | 7       | 40°     |
| SNTP4008SS    | Stainless | 8       | 40°     |
| <b>\$6.87</b> |           |         |         |



STANDARD CAP

### NOZZLE CAPS

SPRAYING SYSTEMS CO.

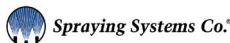

| PRICE  | PART #         | MATERIAL  | STYLE    |
|--------|----------------|-----------|----------|
| \$1.32 | SNCP1325       | Brass     | Hex      |
| \$0.82 | SNCP8027       | Nylon     | Standard |
| \$5.72 | SNCP1325SS     | Stainless | Hex      |
| \$1.19 | SNCP18032A-NYB | Nylon     | Winged   |



### NOZZLE BODY

SPRAYING SYSTEMS CO.

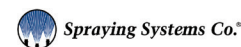

- Bodies have male thread for TeeJet® caps & fit various pipe thread sizes listed below.

| PRICE   | PART #     | MATERIAL        | THREAD     |
|---------|------------|-----------------|------------|
| \$2.22  | SNCP1322   | Brass           | 1/4" M     |
| \$2.22  | SNCP1321   | Brass           | 1/4" F x M |
| \$2.22  | SNCP1336   | Brass           | 1/8" M     |
| \$1.46  | SNCP12094  | Nylon           | 1/4" F     |
| \$1.48  | SNCP8028   | Nylon           | 1/4" M     |
| \$10.55 | SNCP1322SS | Stainless Steel | 1/4" M     |
| \$10.55 | SNCP1321SS | Stainless Steel | 1/4" M x F |
| \$10.55 | SNCP1336SS | Stainless Steel | 1/8" M     |

### BRASS ADJUSTABLE BALL FITTING

SPRAYING SYSTEMS CO.

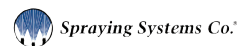

- 1/4" M x 1/4" F with 1" hex and 45° angle of adjustment

**\$13.11** SN36275-44

### TEEJET® FITTING ADAPTER

SPRAYING SYSTEMS CO.

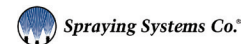

- Replaces spray tips and are used for attaching drop pipes to nozzle bodies or adding extensions to GunJet Spray guns and trigger valves
- Brass • 1" • 1/8" NPT Female Outlet

**\$6.15** SNCP4928

### METERING PLATES

SPRAYING SYSTEMS CO.

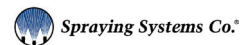

| PRICE  | PART #      | #  | MATERIAL  |
|--------|-------------|----|-----------|
| \$2.02 | SNCP4916-39 | 39 | Stainless |

### STRAINERS

SPRAYING SYSTEMS CO.

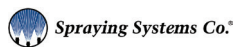

- With Stainless Steel, Brass, or Poly Screens

| PRICE  | PART #        | MESH | MATERIAL |
|--------|---------------|------|----------|
| \$0.97 | SNCP8079PP24  | 24   | Poly     |
| \$0.97 | SNCP8079PP50  | 50   | Poly     |
| \$0.97 | SNCP8079PP100 | 100  | Poly     |
| \$0.97 | SNCP8079PP200 | 200  | Poly     |
| \$2.20 | SNTJ505350    | 50   | Brass    |
| \$2.20 | SNTJ5053100   | 100  | Brass    |

### STRAINERS WITH CHECK VALVE

SPRAYING SYSTEMS CO.

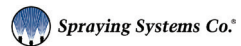

- With Stainless Steel Screens

| PRICE   | PART #         | MESH | MATERIAL  |
|---------|----------------|------|-----------|
| \$3.20  | SNTJ4193APP205 | 50   | Stainless |
| \$3.10  | SNTJ4193PP2080 | 80   | Stainless |
| \$3.11  | SNTJ4193PP524  | 24   | Stainless |
| \$3.11  | SNTJ4193PP550  | 50   | Stainless |
| \$15.86 | SNTJ4193SS1050 | 50   | Stainless |
| \$15.86 | SNTJ4193SS201  | 100  | Stainless |
| \$15.86 | SNTJ4193SS550  | 50   | Stainless |

# BAY ACCESSORIES

## SPRAY ARCH ASSEMBLIES & MORE

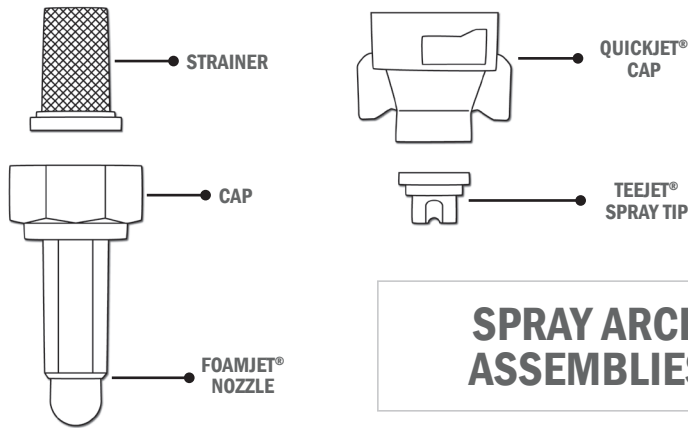

### SPRAY ARCH ASSEMBLIES

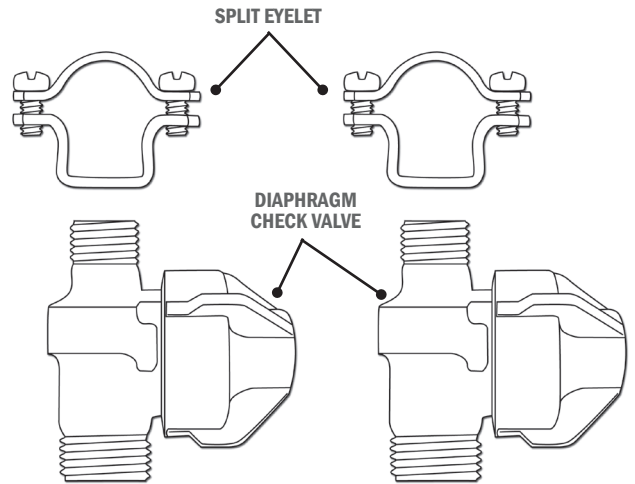

### QUICK RELEASE CHECK VALVE

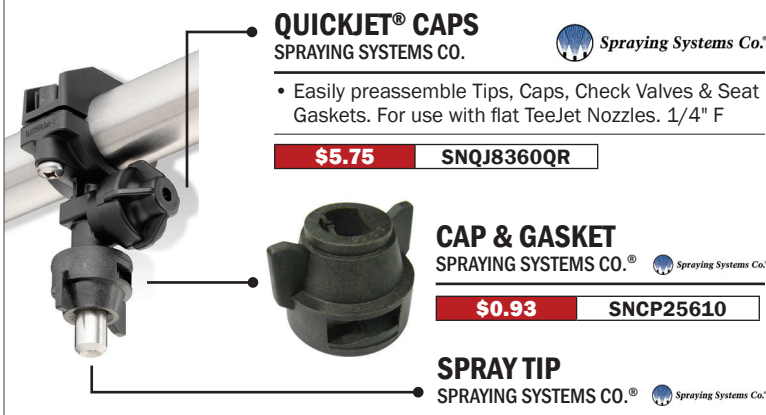

#### QUICKJET® CAPS

SPRAYING SYSTEMS CO. *Spraying Systems Co.*

- Easily preassemble Tips, Caps, Check Valves & Seat Gaskets. For use with flat TeeJet Nozzles. 1/4" F

**\$5.75** SNQJ8360QR

#### CAP & GASKET

SPRAYING SYSTEMS CO. *Spraying Systems Co.*

**\$0.93** SNCP25610

#### SPRAY TIP

SPRAYING SYSTEMS CO. *Spraying Systems Co.*

### SPLIT EYELET BODY

SPRAYING SYSTEMS CO. *Spraying Systems Co.*

- More types and sizes available
- Easiest & fastest way to mount spray nozzles to a boom. To install nozzles, drill hole, insert split-eyelet inlet & clamp assembly in place. Leak-proof gasket connection.

**\$3.80** SETJ742108 1/2" Nylon  
SETJ742112 3/4" Nylon



### EPDM DIAPHRAGM

SPRAYING SYSTEMS CO. *Spraying Systems Co.*

- Black

**\$0.37** SNCP21953EPR

### VITON DIAPHRAGM

SPRAYING SYSTEMS CO. *Spraying Systems Co.*

- Brown

**\$1.40** SNCP21953VI



### UNIJET® ADAPTER

SPRAYING SYSTEMS CO. *Spraying Systems Co.*

- Permits use of standard 1/4" MPT nozzles with QuickJet® assemblies. Made of Celcon with EPDM seat gasket.

**\$2.42** SNQJ4676

### REGULAR PIPE THREAD STYLE

SPRAYING SYSTEMS CO. *Spraying Systems Co.*

- Easy to install
- 1/4" F Thread
- 1/4" stainless steel

**\$5.98** SE75210804 1/2"  
SE7521124ZB 3/4"



### "DRIP FREE" DIAPHRAGM CHECK VALVE

SPRAYING SYSTEMS CO. *Spraying Systems Co.*

- Ideal choice for chemical or soap arches

### REGULAR CHECK VALVE

SPRAYING SYSTEMS CO. *Spraying Systems Co.*

- 1/4" NPT

**\$10.29** SNQJ8360NYB

### 1/4" FEMALE ADAPTER

SPRAYING SYSTEMS CO. *Spraying Systems Co.*

**\$1.59** SNTJ4676NYB

# BAY ACCESSORIES

## SPRAY ARCH ASSEMBLIES & TURBO NOZZLES



### PROMAX® CLIP-EYELET NOZZLES NOZZLES

- Combines a "snap-on" pipe connection with easy-to-install and replace spray tips for versatility
- Adjustable, swivel-type ball makes fast work of changing the direction of the spray without disturbing the pipe connection. It fits 1" pipes with 9/16" holes
- Spray lignment can be finely tuned to minimize overspray
- Flat spray tips are automatically locked into alignment each and every time
- Nozzle is well suited for spraying phosphates, acids, solvents, and other caustics, making it ideal for cleaning, rinsing, conversion coating, and wetting applications
- **MAX PRESSURE:** 60 PSI      • **MAX TEMP.:** 180° F.

**\$10.75**    SN46500A-1-PP

USED  
WITH  
BOTH



### 1/4" THREADED BALL NOZZLES

- The threaded ball accepts a wide variety of conventional spray nozzles. For use with ProMax Clip-Eyelet nozzle & Adjustable Ball Type Nozzle Body

**\$2.34**    SNCP20582



### 1/4" ADJUSTABLE BALL TYPE NOZZLE BODY NOZZLES

- Threaded pipe connection - quick, convenient positioning of the spray tip for accurate spray alignment and reduced overspray
- Easily removed for cleaning and replacement while color coding speeds changeout
- Retaining cap holds the tip in position, even when the nozzle is jarred or vibrated
- **BODY:** Polypropylene      • **CAP:** Polyphthalamide      • **O-RING:** EPDM      • **MAX PSI:** 125      • **MAX TEMP.:** 180° F.

**\$7.55**    SNAB37235



### TURBO LASER NOZZLE GIANT NOZZLES

**GIANT**  
Performance Under Pressure

- **MAX. CONT. PSI:** 3200      • **MAX. PSI:** 3600      • **MAX. TEMP.:** 195° F      • **INLET:** 1/4" BSP-F
- **STREAM:** 0°      • **SPRAY PATTERN:** 20°      • **HOUSING:** Brass      • **ROTOR:** Ceramic

| PRICE          | ITEM #      | SIZE |
|----------------|-------------|------|
| <b>\$50.10</b> | PU23800-30C | 3.0  |
| <b>\$50.10</b> | PU23800-35C | 3.5  |
| <b>\$50.10</b> | PU23800-40C | 4.0  |
| <b>\$50.10</b> | PU23800-45C | 4.5  |

| PRICE          | ITEM #      | SIZE |
|----------------|-------------|------|
| <b>\$50.10</b> | PU23800-50C | 5.0  |
| <b>\$50.10</b> | PU23800-55C | 5.5  |
| <b>\$50.10</b> | PU23800-60C | 6.0  |



### TURBO LASER NOZZLE WITH 2 PIECE PLASTIC NOZZLE COVER GIANT NOZZLES

**GIANT**  
Performance Under Pressure

- **MAX. PSI:** 5800      • **MAX. TEMP.:** 195° F      • **INLET:** 1/4" BSP-F      • **MAX. FLOW:** 18.7 GPM
- **STREAM:** 0°      • **SPRAY PATTERN:** 20°      • **NOZZLE:** Brass      • **ROTOR:** Ceramic

| PRICE          | ITEM #     | SIZE |
|----------------|------------|------|
| <b>\$84.72</b> | PU22060-20 | 2.0  |
| <b>\$84.72</b> | PU22060-30 | 3.0  |
| <b>\$84.72</b> | PU22060-35 | 3.5  |
| <b>\$84.72</b> | PU22060-40 | 4.0  |
| <b>\$84.72</b> | PU22060-50 | 5.0  |

| PRICE          | ITEM #      | SIZE |
|----------------|-------------|------|
| <b>\$84.72</b> | PU22060-55  | 5.5  |
| <b>\$84.72</b> | PU22060-70  | 7.0  |
| <b>\$84.72</b> | PU22060-80  | 8.0  |
| <b>\$84.72</b> | PU22060-120 | 12.0 |



### TURBO LASER NOZZLE GIANT NOZZLES

**GIANT**  
Performance Under Pressure

- **MAX. PSI:** 3600      • **MAX. TEMP.:** 195° F      • **INLET:** 1/4" BSP-F      • **MAX. FLOW:** 18.5 GPM
- **STREAM:** 0°      • **SPRAY PATTERN:** 20°      • **NOZZLE:** Brass      • **ROTOR:** Ceramic

| PRICE          | ITEM #     | SIZE |
|----------------|------------|------|
| <b>\$54.36</b> | PU22040-20 | 2.0  |
| <b>\$54.36</b> | PU22040-30 | 3.0  |
| <b>\$54.36</b> | PU22040-35 | 3.5  |
| <b>\$54.36</b> | PU22040-40 | 4.0  |
| <b>\$54.36</b> | PU22040-50 | 5.0  |
| <b>\$54.36</b> | PU22040-55 | 5.5  |

| PRICE          | ITEM #     | SIZE |
|----------------|------------|------|
| <b>\$54.36</b> | PU22040-60 | 6.0  |
| <b>\$54.36</b> | PU22040-70 | 7.0  |
| <b>\$54.36</b> | PU22040-80 | 8.0  |
| <b>\$54.36</b> | PU22040-85 | 8.5  |
| <b>\$54.36</b> | PU22040-10 | 10.0 |

# BAY ACCESSORIES

## TURBO & HIGH IMPACT NOZZLES



### TURBO NOZZLES

AR NORTH AMERICA



- It delivers great rotating action that moves high pressure water in a circle, allowing you to clean a much larger area than with a non-rotating model. It has a dark green tip for easy identification at a glance.
- **INLET:** 1/4" • **MAX. PRESSURE:** 3700 PSI • **MAX. TEMP.:** 195°F

| PRICE          | PART #           | SIZE | ID COLOR   |
|----------------|------------------|------|------------|
| <b>\$47.12</b> | <b>ARTPR2530</b> | 4.0  | Dark Green |
| <b>\$47.12</b> | <b>ARTPR2550</b> | 6.0  | Purple     |

| PRICE          | PART #           | SIZE | ID COLOR |
|----------------|------------------|------|----------|
| <b>\$47.12</b> | <b>ARTPR2570</b> | 7.0  | Gray     |



AVAILABLE IN OTHER SIZES!

### 357, 456 & 457 TURBO NOZZLES

SUTTNER



| PRICE           | ITEM #            | GPM  | PSI  |
|-----------------|-------------------|------|------|
| <b>\$59.93</b>  | <b>SUT357-3</b>   | 3.0  | 3625 |
| <b>\$59.93</b>  | <b>SUT357-4</b>   | 4    | 3625 |
| <b>\$59.93</b>  | <b>SUT357-4.5</b> | 4.5  | 3625 |
| <b>\$59.93</b>  | <b>SUT357-5</b>   | 5.0  | 3625 |
| <b>\$59.93</b>  | <b>SUT357-5.5</b> | 5.5  | 3625 |
| <b>\$65.18</b>  | <b>SUT357-9</b>   | 9.0  | 3625 |
| <b>\$65.18</b>  | <b>SUT357-10</b>  | 10.0 | 3625 |
| <b>\$108.01</b> | <b>SUT457-4.5</b> | 4.5  | 6000 |
| <b>\$108.01</b> | <b>SUT457-7</b>   | 7    | 6000 |
| <b>\$108.01</b> | <b>SUT457-8</b>   | 8    | 6000 |

| PRICE          | ITEM #            | GPM | PSI  |
|----------------|-------------------|-----|------|
| <b>\$78.07</b> | <b>SUT456-3.0</b> | 3.0 | 5070 |
| <b>\$78.07</b> | <b>SUT456-3.5</b> | 3.5 | 5070 |
| <b>\$78.07</b> | <b>SUT456-4.0</b> | 4.0 | 5070 |
| <b>\$78.07</b> | <b>SUT456-4.5</b> | 4.5 | 5070 |
| <b>\$78.07</b> | <b>SUT456-5.0</b> | 5.0 | 5070 |
| <b>\$78.07</b> | <b>SUT456-5.5</b> | 5.5 | 5070 |
| <b>\$78.07</b> | <b>SUT456-6.0</b> | 6.0 | 5070 |
| <b>\$78.07</b> | <b>SUT456-7.0</b> | 7.0 | 5070 |
| <b>\$78.07</b> | <b>SUT456-8.0</b> | 8.0 | 5070 |



### WASHJET® NOZZLES

SPRAYING SYSTEMS CO

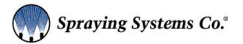

- For high-pressure applications, WashJet nozzles provide superior, high-impact performance
- Uniform distribution by using internal guide vane to stabilize liquid turbulence
- Quick visual reference for spray alignment with milled side flats
- Longer wear life and flow control accuracy with especially hardened stainless steel construction.
- 23990 - Additional exterior protection provided by a nylon outer covering

| PRICE          | ITEM #               | ORIFICE | SIZE |
|----------------|----------------------|---------|------|
| <b>\$25.45</b> | <b>SN23990M4-020</b> | 2.0     | 1/4" |
| <b>\$25.45</b> | <b>SN23990M4-035</b> | 3.5     | 1/4" |

| PRICE          | ITEM #               | ORIFICE | SIZE |
|----------------|----------------------|---------|------|
| <b>\$25.45</b> | <b>SN23990M4-045</b> | 4.5     | 1/4" |
| <b>\$25.45</b> | <b>SN23990M4-055</b> | 5.5     | 1/4" |



USED TOGETHER



POWERJET NOZZLE

ORIFICE CARTRIDGE

### POWERJET TURBO NOZZLES

SPRAYING SYSTEMS CO

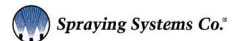

- The PowerJet Spray Nozzle's oscillating solid stream delivers a flat spray pattern that is 50% more powerful at the same pressures than conventional flat spray nozzles. An excellent substitute for expensive rotary nozzles.
- Interchangeable high performance, thermo-plastic cartridges create a flat spray pattern without rotating devices while providing exceptional corrosion resistance.
- No moving parts
- 40 mesh stainless steel filter (SNPJF23508) prevents clogging

**\$35.84** SNPJ23504

### ORIFICE CARTRIDGES

SPRAYING SYSTEMS CO®

|                |                |           |                |                |           |
|----------------|----------------|-----------|----------------|----------------|-----------|
| <b>\$41.57</b> | <b>SNPJC04</b> | <b>#4</b> | <b>\$41.57</b> | <b>SNPJC06</b> | <b>#6</b> |
| <b>\$41.57</b> | <b>SNPJC05</b> | <b>#5</b> | <b>\$38.08</b> | <b>SNPJC08</b> | <b>#8</b> |

### 40 MESH FILTER

SPRAYING SYSTEMS CO®

**\$3.48** SNPJF23508

# BAY ACCESSORIES

## NOZZLES

### AQUA-ROCKET™ INDUSTRIAL TURBO NOZZLES

HYDRA-FLEX NOZZLES



- DESIGNED SPECIFICALLY FOR INDUSTRIAL CLEANING APPLICATIONS SUCH AS PIT CLEANING, WALL CLEANING, AND PRESSURE WASHING
- MAX. INLET PRESSURE: 5,000 PSI
- MAX. TEMP.: 212 °F (100 °C)
- HOUSING MATERIAL: Stainless steel
- FLOW RATE: 3.0 GPM to 5.00 GPM
- NOZZLE MATERIAL: Tungsten Carbide



| PRICE    | PART #      | NOZZLE | GPM | REPAIR KIT   |
|----------|-------------|--------|-----|--------------|
| \$240.00 | HFN2402-030 | 3.0    | 3.0 | HFN2402-030K |
| \$240.00 | HFN2402-035 | 3.5    | 3.5 | HFN2402-035K |
| \$240.00 | HFN2402-040 | 4.0    | 4.0 | HFN2402-040K |
| \$240.00 | HFN2402-045 | 4.5    | 4.5 | HFN2402-045K |
| \$240.00 | HFN2402-050 | 5.0    | 5.0 | HFN2402-050K |

FLOW RATE BASED ON 4,000 PSI

### BLAST-FORCE™ NOZZLES

HYDRA-FLEX NOZZLES



- DESIGNED SPECIFICALLY FOR PIVOTING, OSCILLATING, OR SPINNING HIGH-PRESSURE APPLICATIONS.
- MAX. INLET PRESSURE: 1,000 PSI
- MAX. TEMP.: +180 °F (+82 °C)
- HOUSING MATERIAL: Stainless Steel
- FLOW RATE: 0.50 GPM to 6.00 GPM
- WEIGHT: 0.27 lbs..
- NOZZLE MATERIAL: Tungsten Carbide



### STAINLESS STEEL HIGH PRESSURE NOZZLES

HYDRA-FLEX BLAST-FORCE NOZZLES

FLOW RATE BASED ON 1,000 PSI

| PRICE   | PART #  | NOZZLE | GPM  | REPLACEMENT PILL |
|---------|---------|--------|------|------------------|
| \$77.70 | BFN2010 | 1.0    | .50  | BFN1010          |
| \$77.70 | BFN2020 | 2.0    | 1.00 | BFN1020          |
| \$77.70 | BFN2030 | 3.0    | 1.50 | BFN1030          |
| \$77.70 | BFN2040 | 4.0    | 2.00 | BFN1040          |
| \$77.70 | BFN2050 | 5.0    | 2.50 | BFN1050          |
| \$77.70 | BFN2060 | 6.0    | 3.00 | BFN1060          |
| \$77.70 | BFN2080 | 8.0    | 4.00 | BFN1080          |
| \$77.70 | BFN2100 | 10.0   | 5.00 | BFN1100          |
| \$77.70 | BFN2120 | 12.0   | 6.00 | BFN1120          |

### ADAPTERS

HYDRA-FLEX BLAST-FORCE NOZZLES

|         |            |   |
|---------|------------|---|
| \$14.20 | BFA213-124 | 3/4" - 16 - 37° JIC x 1/4" MNPT (Straight, Brass) |
| \$63.00 | BFN0670    | 1/4" MNPT x 1/4" FNPT (Elbow)                     |

### BLAST-TEC PRO™ ROTATING NOZZLES

HYDRA-FLEX NOZZLES



- DESIGNED SPECIFICALLY FOR HIGH-PRESSURE, HIGH-IMPACT VEHICLE WASH APPLICATIONS INCLUDING WHEEL BLASTERS, UNDERCARRIAGE, RINSING & HIGH-PRESSURE CLEANING
- MAX. INLET PRESSURE: 1,000 PSI
- MAX. TEMP.: +120 °F (+49 °C)
- HOUSING MATERIAL: Stainless Steel
- FLOW RATE: 1.0 GPM to 3.0 GPM
- WEIGHT: 0.5 lbs..
- NOZZLE MATERIAL: Tungsten Carbide



### 324 SERIES - 24° ANGLE

HYDRA-FLEX BLAST-TEC PRO ROTATING NOZZLES

FLOW RATE BASED ON 1,000 PSI

| PRICE    | NOZZLE | GPM  | 1/4" BSPP INLET | 1/4" NPT INLET |
|----------|--------|------|-----------------|----------------|
| \$115.70 | 2.0    | 1.00 | BTN1106         | BTN1106        |
| \$115.70 | 3.0    | 1.50 | BTN1107         | BTN1601        |
| \$115.70 | 3.5    | 1.75 | BTN1108         | BTN1602        |
| \$115.70 | 4.0    | 2.00 | BTN1109         | BTN1603        |
| \$115.70 | 4.5    | 2.25 | BTN1110         | BTN1604        |
| \$115.70 | 5.0    | 2.50 | BTN1111         | BTN1605        |
| \$115.70 | 5.5    | 2.75 | BTN1112         | BTN1606        |
| \$115.70 | 6.0    | 3.00 | BTN1113         | BTN1607        |

#### RETROFIT KITS

|            |         |  |
|------------|---------|--|
| \$2,850.50 | BTN1394 | Blast-Tec Retro Fit Kit for Water Wizard                 |
| \$769.60   | BTN1441 | Blast-Tec Retrofit Kit for Sonny's Omni Pivoting Blaster |

#### ADAPTERS

|         |         |                       |
|---------|---------|-----------------------|
| \$11.10 | BTN0572 | 1/4" BSPP x 1/4" MNPT |
|---------|---------|-----------------------|

### 430 SERIES - 30° ANGLE

HYDRA-FLEX BLAST-TEC PRO ROTATING NOZZLES

FLOW RATE BASED ON 1,000 PSI

| PRICE    | NOZZLE | GPM  | 1/4" BSPP INLET | 1/4" NPT INLET |
|----------|--------|------|-----------------|----------------|
| \$128.70 | 2.0    | 1.00 | BTN1631         | BTN1620        |
| \$128.70 | 3.0    | 1.50 | BTN1632         | BTN1621        |
| \$128.70 | 3.5    | 1.75 | BTN1633         | BTN1622        |
| \$128.70 | 4.0    | 2.00 | BTN1634         | BTN1623        |
| \$128.70 | 4.5    | 2.25 | BTN1634         | BTN1624        |
| \$128.70 | 5.0    | 2.50 | BTN1636         | BTN1625        |
| \$128.70 | 5.5    | 2.75 | BTN1637         | BTN1626        |
| \$128.70 | 6.0    | 3.00 | BTN1637         | BTN1627        |

#### ADAPTERS

|         |         |   |
|---------|---------|---|
| \$49.60 | BTN1755 | 1/4" BSPP x 1/4" NPT Knuckle Ball Joint |
| \$11.10 | BTN0572 | 1/4" BSPP x 1/4" MNPT                   |
| \$11.10 | BTN0581 | 1/4" BSPP x 1/8" NPT                    |
| \$9.10  | BTN0988 | 1/4" MBSP x 3/8" FNPT                   |

# BAY ACCESSORIES

## TRIGGER GUNS & LANCES



### BRASS TRIGGERJET® LIGHT DUTY, LOW PRESSURE

SPRAYING SYSTEMS CO.

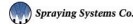

- Trigger valve for detail, tire cleaners, etc.
- **MAX FLOW:** 2 GPM
- **MAX PSI:** 250
- Trigger Valve Only
- **INLET & OUTLET** 1/4" NPT

|                |                |                         |
|----------------|----------------|-------------------------|
| <b>\$34.01</b> | <b>GU0110</b>  | Trigger Valve - No Lock |
| <b>\$7.62</b>  | <b>GU0110K</b> | Repair Kit              |



### STAINLESS STEEL TRIGGER GUN

SPRAYING SYSTEMS CO.

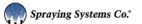

- **INLET** 1/4" NPT
- **MAX PSI:** 150

|                 |                    |             |
|-----------------|--------------------|-------------|
| <b>\$134.55</b> | <b>GUSS3604-SS</b> | Trigger Gun |
| <b>\$12.77</b>  | <b>GUSS3604K</b>   | Repair Kit  |



### PLASTIC TRIGGERJET® LIGHT DUTY, LOW PRESSURE

SPRAYING SYSTEMS CO.

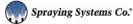

- Trigger lock for continuous flow
- Molded polypropylene
- **INLET** 1/4" FPT
- **MAX PSI:** 150
- Viton diaphragm

|                |               |
|----------------|---------------|
| <b>\$18.99</b> | <b>GUSS50</b> |
|----------------|---------------|

### DID YOU KNOW...

Spraying Systems Co. has a proven track record for maximizing efficiency, minimizing waste and extending nozzle life!



### TRIGGERJET® SPRAYER WITH LANCE

SPRAYING SYSTEMS CO.

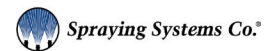

- Molded polypropylene
- Trigger lock for continuous flow
- **MAX PSI:** 150
- 15" polyester extension
- Viton diaphragm
- **INLET & OUTLET** 1/4" FPT

|                |                  |           |
|----------------|------------------|-----------|
| <b>\$29.91</b> | <b>GUSS70</b>    | 15" Model |
| <b>\$34.50</b> | <b>GUSS70-24</b> | 24" Model |

### TRIGGERJET® REPLACEMENT PARTS

SPRAYING SYSTEMS CO.

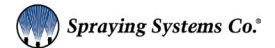

|                     |                    |                     |                          |                     |            |                     |              |
|---------------------|--------------------|---------------------|--------------------------|---------------------|------------|---------------------|--------------|
| <b>SNCP22668PP</b>  | Black Cap          | <b>SNCP387221PP</b> | Black Polypropylene Core | <b>GUSS70-RL</b>    | Lance Only | <b>SNCP22661-VI</b> | Viton Gasket |
| <b>GUSS22663-24</b> | 24" Extension Wand | <b>SNCP77175EPR</b> | O-Ring                   | <b>GUSS22655-PP</b> | Trigger    | <b>SNCP22654</b>    | 1/4" Handle  |
| <b>GUSS22664</b>    | Straight Adapter   | <b>SNCP38721PP</b>  | Tip Body                 | <b>SNCP22657-NY</b> | Stem       |                     |              |



### TRIGGERJET® POLYPROPELENE REPLACEMENT NOZZLES

SPRAYING SYSTEMS CO.

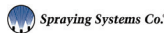

| PRICE         | PART #             | SIZE | PRICE         | PART #              | SIZE |
|---------------|--------------------|------|---------------|---------------------|------|
| <b>\$7.45</b> | <b>SNCJ55X3-PP</b> | #3   | <b>\$7.45</b> | <b>SNCJ55X12-PP</b> | #12  |
| <b>\$7.45</b> | <b>SNCJ55X6-PP</b> | #6   | <b>\$7.45</b> | <b>SNCJ55X18-PP</b> | #18  |
| <b>\$7.45</b> | <b>SNCJ55X8-PP</b> | #8   | <b>\$7.45</b> | <b>SNCJ55X22-PP</b> | #22  |



### TRIGGERJET® BRASS REPLACEMENT NOZZLES

SPRAYING SYSTEMS CO.

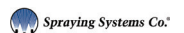

| PRICE          | PART #           | SIZE |
|----------------|------------------|------|
| <b>\$14.57</b> | <b>SNCJ55X8</b>  | #8   |
| <b>\$14.57</b> | <b>SNCJ55X12</b> | #12  |
| <b>\$14.57</b> | <b>SNCJ55X22</b> | #22  |

### WESTERN STYLE TIRE BRUSH WANDS

GOLDEN GATE CAR WASH SERIES



- 22" Long. Give your customers the convenience of cleaning their tires with the a tire brush wand. Brush, non-weep gun and spray tip sold separately.



### 22" FLOW THRU TIRE BRUSH WAND

GOLDEN GATE

|                |                 |
|----------------|-----------------|
| <b>\$29.43</b> | <b>GG22R-FT</b> |
|----------------|-----------------|



### 22" TIRE BRUSH WAND W/ 11" GRIP

GOLDEN GATE

|                |              |
|----------------|--------------|
| <b>\$32.05</b> | <b>GG22R</b> |
|----------------|--------------|



### WHEEL WIZARD BRUSH

GOLDEN GATE CAR WASH SERIES



- Requires F x M Adapter!

|                |                |         |
|----------------|----------------|---------|
| <b>\$15.57</b> | <b>EB47530</b> | Brush   |
| <b>\$7.65</b>  | <b>F0204A</b>  | Adapter |



### ROUND TIRE BRUSH

GOLDEN GATE CAR WASH SERIES



- SOLD SEPARATELY

|                      |               |
|----------------------|---------------|
| <b>\$35.97</b>       | <b>FORNDR</b> |
| <b>FITS DIRECTLY</b> |               |



# BAY ACCESSORIES

## NOZZLE PROTECTORS



### NOZZLE PROTECTORS J.E. ADAMS



- Extend the life of your nozzle and protect the finishes on your customers vehicles with flexible and durable nozzle protectors.

|        |        |                    |
|--------|--------|--------------------|
| \$4.42 | NP4F2F | 1/4" F x 1/8" F    |
| \$4.42 | NP4F4F | 1/4" F x 1/4" F    |
| \$1.07 | NPRR   | Rubber Replacement |



### NOZZLE PROTECTORS KLEEN-RITE



- Colorful nozzle protectors extend the life of your nozzle and protect the finishes on your customers vehicles.

|        |      |       |        |      |          |
|--------|------|-------|--------|------|----------|
| \$1.63 | NPBK | Black | \$1.63 | NPOR | Orange   |
| \$1.63 | NPBL | Blue  | \$1.63 | NPS  | Silver   |
| \$1.63 | NPR  | Red   | \$1.63 | NPHP | Hot Pink |



### NOZZLE PROTECTORS SUTTNER



|        |           |                 |
|--------|-----------|-----------------|
| \$7.38 | SUTNP4F2F | 1/4" F x 1/8" F |
| \$7.38 | SUTNP4F4F | 1/4" F x 1/4" F |



### NOZZLE PROTECTORS SUTTNER



|        |           |                      |
|--------|-----------|----------------------|
| \$6.07 | SUTNP10   | Zinc 1/4"            |
| \$6.68 | SUTNP10SS | Stainless Steel 1/4" |



### NOZZLE PROTECTORS GINSAN



- Can be used with both 1/8" or 1/4" nozzles.

|        |        |       |
|--------|--------|-------|
| \$3.10 | NPGSBL | Blue  |
| \$3.10 | NPGSBK | Black |



### NOZZLE PROTECTORS COMET PUMPS



|        |       |
|--------|-------|
| \$3.08 | NP114 |
|--------|-------|



### ECONOMY NOZZLE PROTECTORS HAMEL MANUFACTURING CO.



|               |       |
|---------------|-------|
| NP139BL       | Blue  |
| NP139R        | Red   |
| NP139BK       | Black |
| <b>\$1.51</b> |       |



### NOZZLE PROTECTORS HAMEL MANUFACTURING CO.



|        |           |               |            |
|--------|-----------|---------------|------------|
| NPHRBK | Black     | NPHRP         | Purple     |
| NPHRBL | Blue      | NPHRLB        | Light Blue |
| NPHRHG | Hot Green | NPHRY         | Yellow     |
| NPHRHP | Hot Pink  | NPHRR         | Red        |
| NPHRO  | Orange    | <b>\$2.36</b> |            |



### NOZZLE PROTECTORS VELOCI PERFORMANCE PRODUCTS



- 1/4" black nozzle

|        |           |                           |
|--------|-----------|---------------------------|
| \$3.44 | MTM410091 | California Proposition 65 |
|--------|-----------|---------------------------|



### NOZZLE PROTECTORS SOUTHERN PRIDE

- 1/8" M x F

|        |        |
|--------|--------|
| \$7.10 | NP2M2F |
|--------|--------|

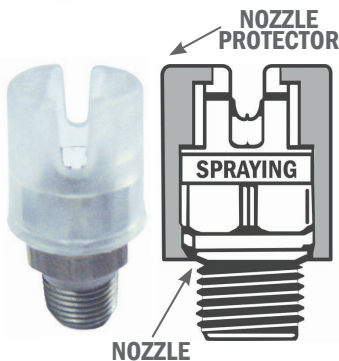

### NOZZLE PROTECTORS SPRAYING SYSTEMS CO.

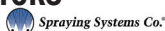

- Fits 1/8" or 1/4" nozzles.

|        |        |
|--------|--------|
| \$1.53 | NP2611 |
|--------|--------|

## KLEEN-RITE HELPFUL HINT:

### EXTEND THE LIFE OF YOUR NOZZLES.

Nozzle protectors help guard from breakage and wear from accidents like a dropped wand.

**CALIFORNIA PROPOSITION 65 NOTE:** some items on this page may fall under the Proposition 65 act. Please consult the State of California Proposition 65 list ([oehha.ca.gov/proposition-65/proposition-65-list](http://oehha.ca.gov/proposition-65/proposition-65-list)) to learn more and to see a comprehensive list of Proposition 65 chemicals.

# BAY ACCESSORIES

## WANDS/LANCES

### SUTTNER UNDERBODY LANCE

SUTTNER



- **MAX PSI:** 3000
- **MAX TEMP:** 300 °F
- **INLET:** 1/4" MPT
- **OUTLET:** 1/4" FNPT
- **WEIGHT:** 6 lbs.
- Ideal for rinsing mud, dirt, snow or salt from under car/truck underbody
- Connects to existing pressure washer
- Ergonomic lance to reduce bending
- Uses 3 threaded MEG nozzles
- Comes with Suttner ST601 Spray Gun
- Lightweight - rolls easy with a long reach
- Plastic coated stainless steel pipe
- Stainless steel "chassis" and POM wheels

| PRICE           | PART #          | MODEL             | PRICE           | PART #          | MODEL         |
|-----------------|-----------------|-------------------|-----------------|-----------------|---------------|
| <b>\$337.40</b> | <b>SUT97810</b> | With Non-Weep Gun | <b>\$345.78</b> | <b>SUT97811</b> | With Weep Gun |

### NICKEL CHROME PLATED LANCE WITH MOLDED GRIP

SUTTNER



- **MAX PSI:** 6000 PSI
- **MAX TEMP:** 300 °F
- **INLET:** 0.25" MPT
- **OUTLET:** 0.25" MPT

| PRICE          | PART #           | LENGTH | PRICE          | PART #           | LENGTH |
|----------------|------------------|--------|----------------|------------------|--------|
| <b>\$9.03</b>  | <b>SUT000180</b> | 24"    | <b>\$22.28</b> | <b>SUT000220</b> | 60"    |
| <b>\$12.23</b> | <b>SUT000210</b> | 47"    | <b>\$24.23</b> | <b>SUT000230</b> | 79"    |

### 18" SPRAY LANCE WANDS

HAMEL MANUFACTURING CO.



- Galvanized molded coated lance wands coated in rainbow colors!
- 1/4" M x 1/8" F - Available in 1/4" M x 1/4" M by special order

| PRICE         | PART #         | COLOR     | PRICE         | PART #         | COLOR  |
|---------------|----------------|-----------|---------------|----------------|--------|
| <b>\$9.40</b> | <b>WTGMLBK</b> | Black     | <b>\$9.40</b> | <b>WTGMLOR</b> | Orange |
| <b>\$9.40</b> | <b>WTGMLBL</b> | Blue      | <b>\$9.40</b> | <b>WTGMLPR</b> | Purple |
| <b>\$9.40</b> | <b>WTGMLHG</b> | Hot Green | <b>\$9.40</b> | <b>WTGMLY</b>  | Yellow |
| <b>\$9.40</b> | <b>WTGMLHP</b> | Hot Pink  | <b>\$9.40</b> | <b>WTGMLR</b>  | Red    |

### INJECTION MOLDED GRIP LANCE WANDS

HAMEL MANUFACTURING CO.



- Galvanized or stainless steel wand with Santoprene grip handle. Part numbers below are M x F. For two male ends, add MM to any of the part numbers. Size: 1/4" x 18"

| GALVANIZED     |                   |       | STAINLESS STEEL |                   |       |
|----------------|-------------------|-------|-----------------|-------------------|-------|
| PRICE          | PART #            | COLOR | PRICE           | PART #            | COLOR |
| <b>\$15.46</b> | <b>WTG418WLBL</b> | Blue  | <b>\$19.36</b>  | <b>WTS418WLBL</b> | Blue  |
| <b>\$15.46</b> | <b>WTG418WLR</b>  | Red   | <b>\$19.36</b>  | <b>WTS418WLR</b>  | Red   |
| <b>\$15.46</b> | <b>WTG418WLBK</b> | Black | <b>\$19.36</b>  | <b>WTS418WLBK</b> | Black |

### DOUBLE LANCE

GENERAL PUMP



- **MAX FLOW:** 10.5 GPM
- **INLET:** 1/4"NPT-M
- **MAX PRESSURE:** 4050 PSI
- **BRASS OUTLET:** 1/4" NPT-F
- **MAX TEMP.:** 320° F.

| PRICE          | PART #          | TYPE          | LENGTH | PRICE          | PART #           | TYPE               | LENGTH |
|----------------|-----------------|---------------|--------|----------------|------------------|--------------------|--------|
| <b>\$60.21</b> | <b>GPNDL33</b>  | Straight/Zinc | 33"    | <b>\$93.62</b> | <b>GPNDL72</b>   | Bent/Zinc          | 72"    |
| <b>\$60.21</b> | <b>GPNDL33B</b> | Bent/Zinc     | 33"    | <b>\$69.90</b> | <b>GPNDL41SS</b> | Straight/Stainless | 41"    |
| <b>\$78.56</b> | <b>GPNDL36</b>  | Bent/Zinc     | 36"    |                |                  |                    |        |

### 20" SPRAY LANCE WAND

MOSMATIC



- Nozzle guards included

**CALL BOMP26980**

### 36" LANCE WAND

KLEEN-RITE



- 1/4" M x 1/4" M

**\$6.51 PWLW36**

### 18" INSULATED LANCE

D&H SPRAY WANDS/LANCES

- Fits 1/4" pipe wand

**\$17.50 WTL22003**

### 20" SPRAY LANCE WAND WITH 8" GRIP

MOSMATIC



- Nozzle guards included

**CALL BOMP26981**

### LANCE HANDLE

LANCE WANDS

- Fits on 1/4" wand pipes

**\$6.45 PU21701**

### SNAP CLIP

D&H SPRAY WANDS/LANCES

- Fastens cover to wand

**\$5.60 WTL22004**

**DON'T FORGET!**



# BAY ACCESSORIES

## WANDS/LANCES

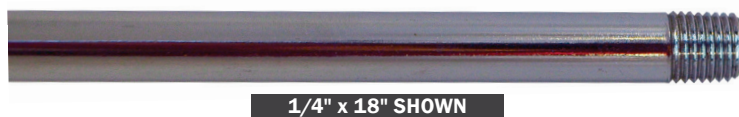
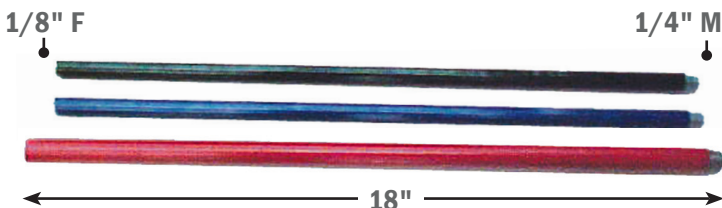

### FULL COVER PROTECTOR WAND

HAMEL MANUFACTURING CO.



- Durable high-impact plastic.
- Nozzle & tip protector holds it together. No need for snap clip!

| FULL COVER WAND PROTECTOR |                  |        |
|---------------------------|------------------|--------|
| <b>\$8.86</b>             | <b>WTLC100Y</b>  | Yellow |
| <b>\$8.86</b>             | <b>WTLC100BK</b> | Black  |

| NOZZLE PROTECTOR |               |       |
|------------------|---------------|-------|
| <b>\$2.36</b>    | <b>NPHRBL</b> | Blue  |
| <b>\$2.36</b>    | <b>NPHRR</b>  | Red   |
| <b>\$2.36</b>    | <b>NPHRBK</b> | Black |

### RUBBER COATED STEEL WAND PIPES

HAMEL MANUFACTURING CO.



- Rubber coating helps prevent scratches to customers vehicle.

|               |                 |       |
|---------------|-----------------|-------|
| <b>\$7.93</b> | <b>WTRC18</b>   | Black |
| <b>\$7.93</b> | <b>WTRC18BL</b> | Blue  |
| <b>\$7.93</b> | <b>WTRC18R</b>  | Red   |

### 18" PROTECTOR WANDS

HAMEL MANUFACTURING CO.



- Protector wands have molded insulating fore grips and tip protector all in one piece. 7/8" outside diameter.

|               |                   |       |
|---------------|-------------------|-------|
| <b>\$8.22</b> | <b>WTRCWNP-BK</b> | Black |
| <b>\$8.22</b> | <b>WTRCWNP-BL</b> | Blue  |
| <b>\$8.22</b> | <b>WTRCWNP-R</b>  | Red   |

### WAND PIPES

HAMEL MANUFACTURING CO.



- Threaded & tapped 1/4" ID pipe

| GALVANIZED     |                 |                  |
|----------------|-----------------|------------------|
| PRICE          | PART #          | SIZE             |
| <b>\$5.01</b>  | <b>WTG418</b>   | 1/4" x 1/8"      |
| <b>\$5.57</b>  | <b>WTG420</b>   | 1/4" x 1/8"      |
| <b>\$6.96</b>  | <b>WTG424</b>   | 1/4" x 1/8"      |
| <b>\$10.04</b> | <b>WTG436</b>   | 1/4" x 1/8"      |
| <b>\$5.01</b>  | <b>WTG418MM</b> | 1/4" x 1/4 M x M |
| <b>\$5.57</b>  | <b>WTG420MM</b> | 1/4" x 1/4 M x M |

| STAINLESS STEEL |                 |                 |
|-----------------|-----------------|-----------------|
| PRICE           | PART #          | SIZE            |
| <b>\$14.61</b>  | <b>WTS418</b>   | 1/4" x 1/8"     |
| <b>\$15.80</b>  | <b>WTS420</b>   | 1/4" x 1/8"     |
| <b>\$14.61</b>  | <b>WTS418MM</b> | 1/4"x 1/4 M x M |
| <b>\$15.80</b>  | <b>WTS420MM</b> | 1/4"x 1/4 M x M |

### CHROME PLATED WANDS WITH MOLDED GRIP

J.E. ADAMS



- Lightweight, easy to handle, customer-friendly • Molded grip

| 1/4" MPT X 1/4" MPT |                   |        |
|---------------------|-------------------|--------|
| PRICE               | PART #            | LENGTH |
| <b>\$5.21</b>       | <b>WTZ418MMWL</b> | 18"    |
| <b>\$6.14</b>       | <b>WTZ424MMWL</b> | 24"    |
| <b>\$7.40</b>       | <b>WTZ436MMWL</b> | 36"    |

| 1/4" MPT X 1/8" FPT |                 |        |
|---------------------|-----------------|--------|
| PRICE               | PART #          | LENGTH |
| <b>\$6.18</b>       | <b>WTZ418WL</b> | 18"    |
| <b>\$12.46</b>      | <b>WTZ424WL</b> | 24"    |
| <b>\$16.92</b>      | <b>WTZ436WL</b> | 36"    |

### LIGHT WEIGHT CHROME WAND TUBE

J.E. ADAMS



- Lightweight, easy to handle, customer friendly

| 1/4" MPT X 1/8" FPT |               |        |
|---------------------|---------------|--------|
| PRICE               | PART #        | LENGTH |
| <b>\$2.93</b>       | <b>WTZ418</b> | 18"    |
| <b>\$4.78</b>       | <b>WTZ424</b> | 24"    |
| <b>\$8.88</b>       | <b>WTZ436</b> | 36"    |

| 1/4" MPT X 1/4" MPT |                 |        |
|---------------------|-----------------|--------|
| PRICE               | PART #          | LENGTH |
| <b>\$2.82</b>       | <b>WTZ418MM</b> | 18"    |
| <b>\$4.12</b>       | <b>WTZ424MM</b> | 24"    |
| <b>\$5.70</b>       | <b>WTZ436MM</b> | 36"    |
| <b>\$17.34</b>      | <b>WTZ470MM</b> | 70"    |

# BAY ACCESSORIES

## WANDS/LANCES



### RUBBER FLEX WANDS™

HAMEL MANUFACTURING CO.



- Galvanized or stainless steel extensions w/flexible center
- INLET PORT:** 1/4" MPT
- MAX PSI:** 2500
- MAX TEMP:** 200°
- OUTLET PORT:** 1/4" MPT x 1/8" FPT (for male or female nozzles)
- AVAILABLE IN 1/4 M x 1/4 M BY SPECIAL ORDER!**

CHECK OUT OUR INFORMATIVE VIDEO ABOUT THIS PRODUCT ON OUR WEBSITE, OR SIMPLY SCAN THIS HANDY QR CODE WITH YOUR HANDHELD MOBILE DEVICE: →



### GALVANIZED RUBBER FLEX WANDS™

HAMEL MANUFACTURING CO.



|         |             |         |           |
|---------|-------------|---------|-----------|
| \$19.85 | WTGRFBK     | 18" MxF | Black     |
| \$19.85 | WTGRFBL     | 18" MxF | Blue      |
| \$19.85 | WTGRFHG     | 18" MxF | Hot Green |
| \$19.85 | WTGRFHP     | 18" MxF | Hot Pink  |
| \$19.85 | WTGRFOR     | 18" MxF | Orange    |
| \$19.85 | WTGRFPR     | 18" MxF | Purple    |
| \$19.85 | WTGRFR      | 18" MxF | Red       |
| \$19.85 | WTGRFY      | 18" MxF | Yellow    |
| \$22.19 | WTGRF21BK   | 21" MxF | Black     |
| \$22.19 | WTGRF21BKMM | 21" MxM | Black     |
| \$22.19 | WTGRF21BL   | 21" MxF | Blue      |
| \$22.19 | WTGRF21BLMM | 21" MxM | Blue      |
| \$22.19 | WTGRF21R    | 21" MxF | Red       |
| \$22.19 | WTGRF21RMM  | 21" MxM | Red       |
| \$22.70 | WTGRF24BK   | 24" MxF | Black     |
| \$22.70 | WTGRF24BKMM | 24" MxM | Black     |
| \$22.70 | WTGRF24BL   | 24" MxF | Blue      |
| \$22.70 | WTGRF24BLMM | 24" MxM | Blue      |
| \$22.70 | WTGRF24R    | 24" MxF | Red       |
| \$22.70 | WTGRF24RMM  | 24" MxM | Red       |

### STAINLESS STEEL RUBBER FLEX WANDS™

HAMEL MANUFACTURING CO.



|         |             |         |           |
|---------|-------------|---------|-----------|
| \$23.93 | WTSRFBK     | 18" MxF | Black     |
| \$23.93 | WTSRFBL     | 18" MxF | Blue      |
| \$23.93 | WTSRFHG     | 18" MxF | Hot Green |
| \$23.93 | WTSRFHP     | 18" MxF | Hot Pink  |
| \$23.93 | WTSRFOR     | 18" MxF | Orange    |
| \$23.93 | WTSRFPR     | 18" MxF | Purple    |
| \$23.93 | WTSRFR      | 18" MxF | Red       |
| \$23.93 | WTSRFY      | 18" MxF | Yellow    |
| \$29.46 | WTSRF21BK   | 21" MxF | Black     |
| \$29.46 | WTSRF21BKMM | 21" MxM | Black     |
| \$29.46 | WTSRF21BL   | 21" MxF | Blue      |
| \$29.46 | WTSRF21BLMM | 21" MxM | Blue      |
| \$29.46 | WTSRF21R    | 21" MxF | Red       |
| \$29.46 | WTSRF21RMM  | 21" MxM | Red       |
| \$34.15 | WTSRF24BK   | 24" MxF | Black     |
| \$34.15 | WTSRF24BKMM | 24" MxM | Black     |
| \$34.15 | WTSRF24BL   | 24" MxF | Blue      |
| \$34.15 | WTSRF24BLMM | 24" MxM | Blue      |
| \$34.15 | WTSRF24R    | 24" MxF | Red       |
| \$34.15 | WTSRF24RMM  | 24" MxM | Red       |

### SPRING FLEX WAND

WANDS

|         |            |   |
|---------|------------|---|
| \$13.50 | WTSPF14    | 1/4" x 14" M x M - No nozzle protector      |
| \$16.99 | WTSPF14-02 | 1/4" x 14" M x M with 1/8" Nozzle Protector |
| \$16.99 | WTSPF14-04 | 1/4" x 14" M x M with 1/4" Nozzle Protector |

### ECONOMY RUBBER FLEX WAND® SPRAYERS

HAMEL MANUFACTURING CO.



|         |         |                   |
|---------|---------|-------------------|
| \$14.52 | WTERFR  | Red Zinc-Plated   |
|         | WTERFBL | Blue Zinc-Plated  |
|         | WTERFBK | Black Zinc-Plated |

### WESTERN STYLE FLEXIBLE PROTECTOR WANDS

GOLDEN GATE CAR CARE SERIES



- 15" Long, Flexible Wand comes with fixed nozzle protector.

**\$30.00** GGS15BL

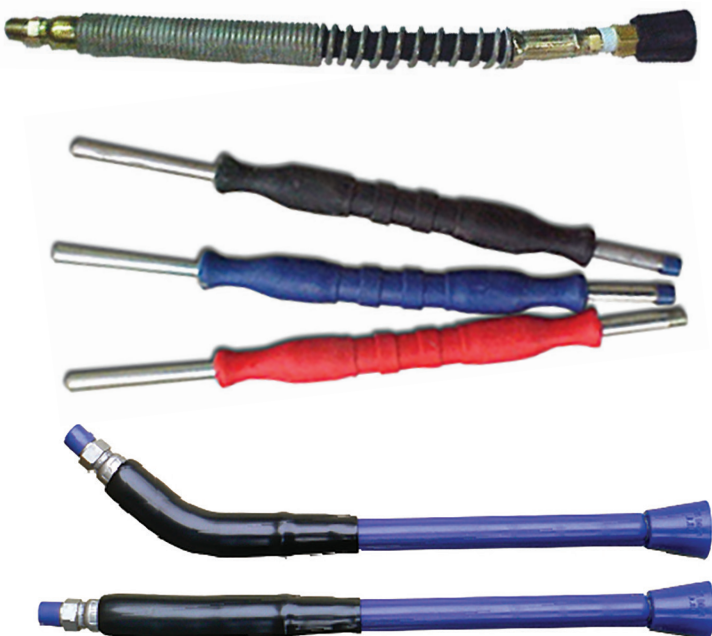

# BAY ACCESSORIES

## FOAMY BRUSH HANDLES



### X-TRA HEAVY DUTY COATED ALUMINUM FOAMY BRUSH HANDLES

HAMEL MANUFACTURING CO.



• 40" Handles • 3/8" FIP x 1/2" MIP

|                |           |                |            |
|----------------|-----------|----------------|------------|
| <b>FHA40BK</b> | Black     | <b>FHA40OR</b> | Hot Orange |
| <b>FHA40BL</b> | Blue      | <b>FHA40PR</b> | Purple     |
| <b>FHA40EG</b> | Evergreen | <b>FHA40R</b>  | Red        |
| <b>FHA40HG</b> | Green     | <b>FHA40Y</b>  | Yellow     |
| <b>FHA40HP</b> | Hot Pink  | <b>FHA40G</b>  | Gray       |
| <b>\$15.81</b> |           | <b>\$15.81</b> |            |

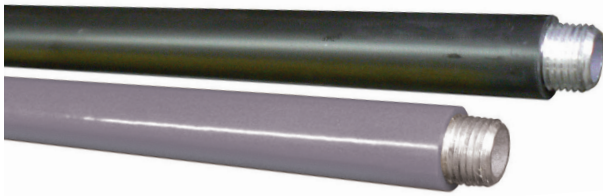

### STEEL & PVC FOAMY BRUSH HANDLES

HAMEL MANUFACTURING CO.



|                |                |              |  |
|----------------|----------------|--------------|--|
| <b>\$12.96</b> | <b>FHP40</b>   | PVC Handle   | Gray - 40" x 3/4" w/Fitting 3/8" FIP x 1/2" MIP                |
| <b>\$17.09</b> | <b>FHS40BK</b> | STEEL Handle | Black - 40" X-tra Heavy Duty Rubber Coated 3/8" FIP x 1/2" MIP |

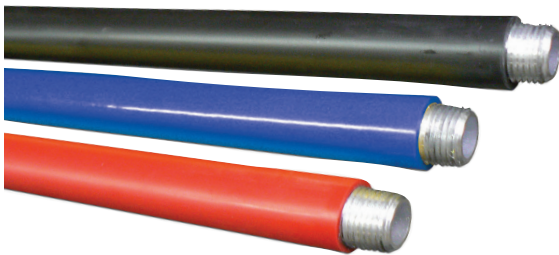

### FOAMY BRUSH HANDLES

HAMEL MANUFACTURING CO.



#### 60" LONG

HAMEL MANUFACTURING CO.

|                |                |       |
|----------------|----------------|-------|
| <b>\$19.77</b> | <b>FHA60BL</b> | Blue  |
|                | <b>FHA60BK</b> | Black |
|                | <b>FHA60R</b>  | Red   |

#### 72" LONG

HAMEL MANUFACTURING CO.

|                |                |       |
|----------------|----------------|-------|
| <b>\$24.88</b> | <b>FHA72BL</b> | Blue  |
|                | <b>FHA72BK</b> | Black |
|                | <b>FHA72R</b>  | Red   |



### SEMITRANSSPARENT FOAMY BRUSH HANDLE

HAMEL MANUFACTURING CO.



• 40" Long • Lightweight polycarbonate material

**\$20.83** **FHC40**



### 40" FOAMY BRUSH HANDLES

VALUE LINE PRODUCTS



|                |                  |       |
|----------------|------------------|-------|
| <b>\$10.05</b> | <b>KRV1220BK</b> | Black |
|                | <b>KRV1220BL</b> | Blue  |
|                | <b>KRV1220R</b>  | Red   |

### MOLDED GRIP FOAMY HANDLE

GOLDEN GATE CAR WASH SUPPLIES



• 36" Long • Injected Molded Handle Grip

**\$35.45** **GG36BL**



# BAY ACCESSORIES

## FOAMY BRUSH HOSES

### 25' COIL TUBING FOAMY HOSE HOSES

- Comes with fittings

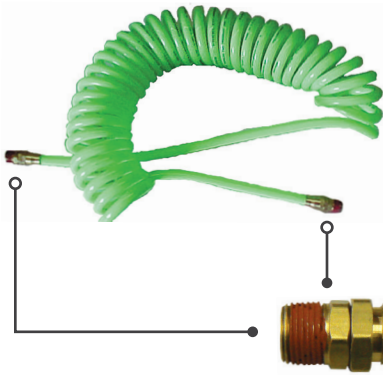

| 1/4" 25 FEET |           |                 |  |
|--------------|-----------|-----------------|--|
| \$30.83      | CT2504BWF | Blue            |  |
| \$30.83      | CT2504CWF | Clear/Blue Tint |  |
| \$30.83      | CT2504GWF | Hot Green       |  |
| \$30.83      | CT2504RWF | Red             |  |
| \$30.83      | CT2504YWF | Yellow          |  |

| 3/8" 25 FEET |           |                 |  |
|--------------|-----------|-----------------|--|
| \$57.61      | CT2506BWF | Blue            |  |
| \$57.61      | CT2506CWF | Clear/Blue Tint |  |
| \$57.61      | CT2506GWF | Hot Green       |  |
| \$57.61      | CT2506RWF | Red             |  |
| \$57.61      | CT2506YWF | Yellow          |  |

| 5/16" 25 FEET |           |           |  |
|---------------|-----------|-----------|--|
| \$45.54       | CT2505BWF | Blue      |  |
| \$45.54       | CT2505CWF | Clear     |  |
| \$45.54       | CT2505GWF | Hot Green |  |
| \$45.54       | CT2505YWF | Yellow    |  |

### REPLACEMENT COIL TUBING FOAMY HOSE FITTINGS

POLY TUBING

|        |        |                          |        |        |                         |
|--------|--------|--------------------------|--------|--------|-------------------------|
| \$6.58 | CTF44S | 1/4" CT x 1/4" M Swivel  | \$8.50 | CTF64S | 3/8" CT x 1/4" M Swivel |
| \$8.04 | CTF56S | 5/16" CT x 3/8" M Swivel | \$8.50 | CTF66S | 3/8" CT x 3/8" M Swivel |

### TRIPLE FOAM COILED HOSE

FREELIN-WADE HOSES

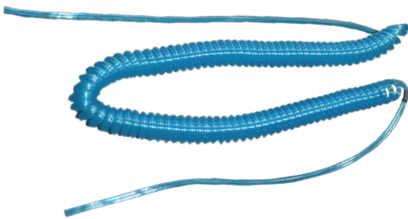

- Bonded ribbon Fre-Thane 95a polyurethane tubing material provides a clean wash with no unwanted residue or incomplete sealing. Reliable triple foam washes for your customers on every application, facilitated with a durable coil hose!
- 33' working length - 3 transparent blue tint tubes bonded together
- Hose only, fittings NOT included

**\$92.99** CT1000

## POLY FLEX FOAMY BRUSH HOSES

### BULK HOSE

POLY FLEX FOAMY BRUSH HOSE

- 50' OR MORE • 250 PSI

| POLY FLEX  |        |      |        |
|------------|--------|------|--------|
| \$0.55     | HPF06Y | 3/8" | Yellow |
| \$0.53     | HPF06R | 3/8" | Red    |
| \$0.53     | HPF06B | 3/8" | Blue   |
| POLY BRAID |        |      |        |
| \$0.52     | HPB04H | 1/4" | Clear  |
| \$0.73     | HPB06H | 3/8" | Clear  |
| \$0.94     | HPB08H | 1/2" | Clear  |

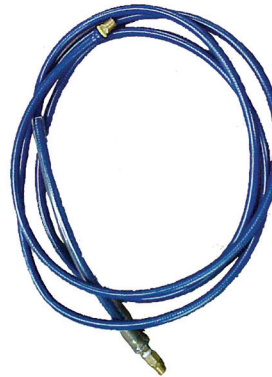

### FOAMY HOSE ASSEMBLY

POLY FLEX FOAMY BRUSH HOSE

- Available in red, blue, and yellow
- 3/8" x 15' long
- One end is equipped with a 3/8" push lock fitting (PLF204) and one end has a HU00606MB fixed male permanent end with a 3/8" MxF low pressure swivel (SW0250) attached
- Clear hose guard on one end for longer hose life

|         |              |        |
|---------|--------------|--------|
| \$18.35 | HA156FBL1443 | Blue   |
| \$18.67 | HA156FY1443  | Yellow |
| \$18.35 | HA156FR1443  | Red    |



## SIGN UP FOR OUR WEEKLY EMAIL BLAST!

### OUR WEEKLY E-BLAST FEATURES:

- Special Sale Offers
- Car Wash Hot Picks
- Featured Videos
- New Product Info
- Industry Calendar
- Sign up on the Kleen-Rite website!

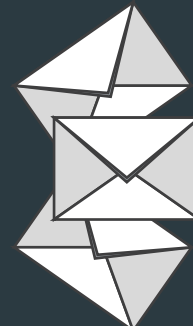

# BAY ACCESSORIES

## FOAMY BRUSH HANDLES

### WOBBLEHEAD 3.0 SMART BRUSH HANDLE

BRUSH HANDLES

Smart Brush Handle

- Precision engineered piston head and pushrod
- Wire braided reinforced flexible Wobble Zone Boot
- Fits all 1/2" foam brushes
- Saves wear and tear on brushes - hogs hair brushes last 2 to 4 times longer!
- Requires your customers to pay for use of your foam brush, generating more revenue for your wash

- 7/16" hardened stainless steel pushrod (guaranteed not to bend)
- Lightweight schedule 80 PVC handle (durable and will not corrode)
- All brass plumbing
- Compatible with all water and soap conditions - foam activates the stainless steel piston into Wobblezone

**\$120.64** FHWB-BK Wobblehead Smart Brush Handle - Black

**BEFORE THEY PAY**

IT'S USELESS!



**AFTER THEY PAY**

IT'S USEFUL!



- Provides a better service for your customer
- Increases your revenue by 5-10%
- Decreases your level of frustration

#### BENEFITS

- Easy to Install - Remove and replace
- No additional equipment to purchase
- Requires the SS customer to pay for the use of your foam brush
- Increases the life of the Hogs hair brush by 2-4x longer
- Fast ROI in as little as 2 months
- Silent Attendant with a passive and polite approach to have your customer pay

### REPLACEMENT PARTS

SMART BRUSH HANDLE

|                |                      |   |
|----------------|----------------------|---|
| <b>\$51.61</b> | <b>FHWB-BOOT</b>     | Aluminum Handle Boot (sold before 2017) 1/2" x 1/2" |
| <b>\$51.61</b> | <b>FHWB-BOOT-3.0</b> | Handle Boot (sold after 2017) 3/4" x 1/2"           |
| <b>\$6.22</b>  | <b>FHWB-SPRING</b>   | Replacement Spring (all since 2010)                 |
| <b>\$14.70</b> | <b>FHWB-GRIP-3.0</b> | Shrink Wrap Tubing (sold after 2017)                |

All materials are now compatible with all water conditions and soap formulas!

## BRUSH AND WAND HOLDERS

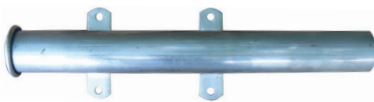

### STAINLESS STEEL NON-FLEXIBLE WAND HOLDER

HAMEL MANUFACTURING CO.

Hamel Manufacturing Co.

### STAINLESS STEEL FLEXIBLE WAND HOLDER

BAY ACCESSORIES

### STAINLESS STEEL WAND HOLDER WITH BUMPER

VALUE LINE

VALUE LINE

|                |              |     |
|----------------|--------------|-----|
| <b>\$22.78</b> | <b>WHS06</b> | 6"  |
| <b>\$44.66</b> | <b>WHS17</b> | 17" |
| <b>\$52.18</b> | <b>WHS22</b> | 22" |
| <b>\$52.87</b> | <b>WHS24</b> | 24" |

- 26" Long • 2 1/2" Diameter
- Fitting on bottom for drip recycling

**\$104.05** WHFS26

- 2.5" O.D.

|                |                |          |
|----------------|----------------|----------|
| <b>\$28.99</b> | <b>KRV1210</b> | 17" Long |
| <b>\$34.99</b> | <b>KRV1212</b> | 22" Long |



### STAINLESS STEEL FLEXIBLE WAND HOLDER

VALUE LINE

VALUE LINE

- 26" long

|                |                |                  |
|----------------|----------------|------------------|
| <b>\$62.75</b> | <b>KRV1214</b> | Wall Mount       |
| <b>\$62.75</b> | <b>KRV1216</b> | Floor Mount      |
| <b>\$6.25</b>  | <b>KRV1217</b> | Replacement Ring |



### FLOOR MOUNTED WAND HOLDER WITH WEEP CONNECTION

MOSMATIC

MOSMATIC

- Length: 27.8" • Inner Diameter: 2.4"
- Outer Base Diameter: 6.3"
- Weep connection 0.8" diameter
- Spring loaded with recovery port
- Solid construction
- Made of high-polished stainless steel

**CALL** BOMP29097



### WAND HOLDER

MOSMATIC

MOSMATIC

- DIMENSIONS: 23.2" x 2.4" • Polished stainless steel
- Tough, durable construction

**CALL** BOMP29083

ALL PRICES ARE F.O.B. AND ARE SUBJECT TO CHANGE WITHOUT NOTICE • NO C.O.D.'S

1-800-233-3873 • (717) 684-6721 • FAX (800) 446-0495 • KLEENRITE.COM

391

# BAY ACCESSORIES

## BRUSH AND WAND & GUN HOLDERS

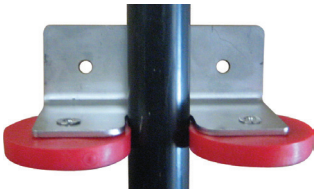

### SNAP-IN STAINLESS STEEL BASE FOAM BRUSH HANDLE HOLDERS

HAMEL MANUFACTURING CO.



|                |                  |      |
|----------------|------------------|------|
| <b>\$17.76</b> | <b>FBHH916</b>   | Red  |
| <b>\$17.76</b> | <b>FBHH916BL</b> | Blue |

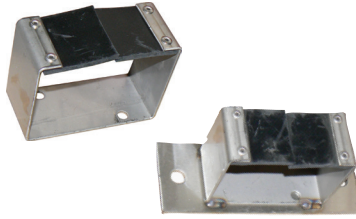

### FOAMY BRUSH HOLDER

BAY ACCESSORIES

|                |                 |            |
|----------------|-----------------|------------|
| <b>\$21.38</b> | <b>FHH300</b>   | Standard   |
| <b>\$24.59</b> | <b>FHH300-R</b> | Reinforced |



### STAINLESS STEEL FOAMY BRUSH BOX HOLDER

BAY ACCESSORIES

- Holds brush horizontally
- Keeps brush from freezing
- Available in left and right configurations

|                 |               |       |
|-----------------|---------------|-------|
| <b>\$130.75</b> | <b>FBHSS</b>  | Right |
| <b>\$147.92</b> | <b>FBHSSL</b> | Left  |

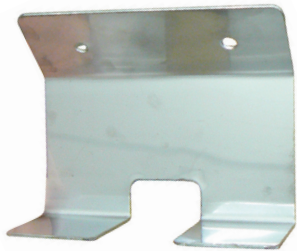

### FOAM BRUSH HOLDER PLATE

BAY ACCESSORIES

|                |             |
|----------------|-------------|
| <b>\$11.55</b> | <b>FBHP</b> |
|----------------|-------------|

### REPLACEMENT RUBBER FOR FOAMY BRUSH HOLDER

FOR FOAMY BRUSH HOLDER

|               |                      |
|---------------|----------------------|
| <b>\$2.41</b> | <b>FHH300-RUBBER</b> |
|---------------|----------------------|



### FOAMY BRUSH BUCKET

HAMEL MANUFACTURING CO.



|                |                 |       |
|----------------|-----------------|-------|
| <b>\$14.04</b> | <b>FBB911R</b>  | Red   |
|                | <b>FBB911BL</b> | Blue  |
|                | <b>FBB911BK</b> | Black |

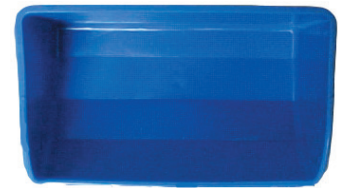

### FOAMY BRUSH BUCKET

BAY ACCESSORIES

- 11" L x 6" W x 6" D
- Use with foamy weep system
- Heavy duty polyethylene

|                |               |       |
|----------------|---------------|-------|
| <b>\$13.90</b> | <b>F00260</b> | Blue  |
| <b>\$13.90</b> | <b>F00261</b> | White |

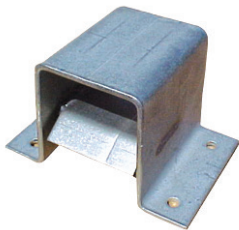

### STAINLESS STEEL GUN HOLDER FOR TRIFOAM GUN

BAY ACCESSORIES

|                |               |
|----------------|---------------|
| <b>\$25.44</b> | <b>TFGHSS</b> |
|----------------|---------------|



### SUPER NOZZLE STAINLESS STEEL HOLDER

ERIE BRUSH



|                |                 |
|----------------|-----------------|
| <b>\$20.11</b> | <b>EB218022</b> |
|----------------|-----------------|

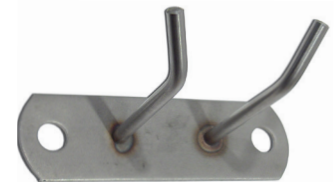

### STAINLESS STEEL 2 PRONG FOAM HOOK BRUSH

HAMEL MANUFACTURING CO.



- 2 prong hook 1½" x 5" L
- 1/2" holes are 4" apart

|                |               |
|----------------|---------------|
| <b>\$11.40</b> | <b>FBH915</b> |
|----------------|---------------|



### J HOOK

HAMEL MANUFACTURING CO.



- Neatly attach hose & brushes to wall
- Pre-drilled mounting holes.

|               |                |               |
|---------------|----------------|---------------|
| <b>\$6.83</b> | <b>FBH919S</b> | Stainless     |
| <b>\$8.03</b> | <b>HHRC6</b>   | Powder Coated |



### BLACK RUBBER COATED GUN HOSE HOOK

KLEEN-RITE



- Stainless steel construction with rubber coating

|               |              |
|---------------|--------------|
| <b>\$9.19</b> | <b>HHRC4</b> |
|---------------|--------------|



### STAINLESS STEEL FOAMY HANDLE HOLDER

BAY ACCESSORIES

|                |                |
|----------------|----------------|
| <b>\$23.50</b> | <b>FHHS316</b> |
|----------------|----------------|



# BAY ACCESSORIES

## MAT CLAMPS



### MAT CLAMPS

HAMEL MANUFACTURING CO.



| PRICE   | PART#    | MATERIAL           | BUMPER | COLOR  | TYPE    |
|---------|----------|--------------------|--------|--------|---------|
| \$12.29 | MCSC35   | Stainless          | Yes    | Red    | Channel |
| \$12.29 | MCSC35BL |                    |        | Blue   |         |
| \$14.27 | MCSC35Y  |                    |        | Yellow |         |
| \$14.27 | MCSC35P  |                    |        | Purple |         |
| \$14.27 | MCSC35G  |                    |        | Green  |         |
| \$2.85  | MCSP50   | Replacement Spring |        |        |         |



### 6 1/2" X 1 1/4" MAT CLAMP DECALS

HAMEL MANUFACTURING CO.



|        |         |        |
|--------|---------|--------|
| \$2.85 | MCD57BL | Blue   |
| \$2.25 | MCD57   | Red    |
| \$2.85 | MCD57P  | Purple |
| \$2.85 | MCD57G  | Green  |
| \$2.85 | MCD57Y  | Yellow |



### MAT CLAMPS

VALUE LINE



- Wall mounted - steel pin included
- Bumper for safe use
- Decal included

| PRICE  | PART#     | COLOR |
|--------|-----------|-------|
| \$8.99 | KRV1200R  | Red   |
| \$8.99 | KRV1200BL | Blue  |



### MAT CLAMP BUMPER

HAMEL MANUFACTURING CO.



- Plastic bumper ensures mat is held firmly in place
- Durable plastic material prevents damage to rubber or fabric mats
- Fits Hamel 825SD and 925 AD clamps

|        |         |        |
|--------|---------|--------|
| \$3.52 | MCB-G   | Green  |
| \$3.52 | MCB-P   | Purple |
| \$3.52 | MCB-RED | Red    |
| \$3.52 | MCB-Y   | Yellow |



### SUPER HEAVY DUTY STAINLESS STEEL FLOOR MAT CLAMP

KLEEN-RITE



- Strong, durable stainless steel, this mat clamp provides an easy place for customers to hang their floor mats - perfect for use at commercial car washes
- Hang on a wall/sturdy flat surface where customers can easily access
- Single mat clamp
- Pre-cut sections for screws and fasteners when hanging
- Lettering directly on metal: MAT CLAMP and PUSH HERE

**\$24.99** **KRMC100**



### STAINLESS STEEL MAT HOLDER WITH PRESSURE ROLLER

MOSMATIC



- **DIMENSIONS:** 12" H x 1.8" W x 2.4" D
- Plastic pressure roller allows for firm clamping without causing damage to floor mats
- 100% stainless steel construction
- 100% maintenance-free design

**CALL** **BOMP90050**

### LIVE SWIVEL



### FOAM BRUSH

MOSMATIC



- Stainless steel brush head
- Non-marking rubber trim
- High quality hogs hair bristles
- Swiveling inlet

|             |                  |     |
|-------------|------------------|-----|
| <b>CALL</b> | <b>BOMP25922</b> | 41" |
|             | <b>BOMP25923</b> | 50" |



### COMPLETE HOGS HAIR HEAD BRUSH

MOSMATIC



- Lightweight design - 1.3 lbs
- 1/4" NPT female Inlet
- 2.4: Natural hogs hair bristles

**CALL** **BOMP29007**



### HOGS HAIR REPLACEMENT BRUSH

MOSMATIC



- Uses foamy brush handle

|             |                  |      |
|-------------|------------------|------|
| <b>CALL</b> | <b>BOMP29011</b> | 2.4" |
|             | <b>BOMP29065</b> | 3.5" |

# BAY ACCESSORIES

## UNIVERSAL BRUSH



### Universal Brush

#### 4" MONSTER HOGS HAIR WITH ALUMINUM HEAD UNIVERSAL BRUSH

- Higher volume of bristles, 20% more density than the standard hogs hair brush
- Uses foamy brush handle

|                |                 |        |
|----------------|-----------------|--------|
| <b>\$73.26</b> | <b>F0211AR</b>  | Red    |
| <b>\$73.26</b> | <b>F0211ABL</b> | Blue   |
| <b>\$73.26</b> | <b>F0211ABK</b> | Black  |
| <b>\$73.26</b> | <b>F0211AY</b>  | Yellow |
| <b>\$73.26</b> | <b>F0211AG</b>  | Green  |
| <b>\$73.26</b> | <b>F0211APR</b> | Purple |



### Universal Brush

#### 4.5" MONSTER XL HOGS HAIR WITH ALUMINUM HEAD UNIVERSAL BRUSH

- Longer length bristles, 20-25% longer than standard hogs hair brush
- Universal's largest foamy brush ever!
- Uses foamy brush handle

|                |                    |       |
|----------------|--------------------|-------|
| <b>\$79.65</b> | <b>F0211AR-XL</b>  | Red   |
| <b>\$79.65</b> | <b>F0211ABL-XL</b> | Blue  |
| <b>\$79.65</b> | <b>F0211ABK-XL</b> | Black |



### Universal Brush

#### 4" MONSTER HOGS HAIR WITH RUBBER COATED HEAD UNIVERSAL BRUSH

- Higher volume of bristles, 20% more density than the standard hogs hair brush
- Uses foamy brush handle

|                |                 |        |
|----------------|-----------------|--------|
| <b>\$72.10</b> | <b>F0212PR</b>  | Red    |
| <b>\$78.49</b> | <b>F0212PBL</b> | Blue   |
| <b>\$72.10</b> | <b>F0212PBK</b> | Black  |
| <b>\$63.42</b> | <b>F0213HR</b>  | Refill |



### Universal Brush

#### 4.5" MONSTER XL HOGS HAIR WITH RUBBER COATED HEAD UNIVERSAL BRUSH

- Longer length bristles, 20-25% longer than standard hogs hair brush
- Universal's largest foamy brush ever!
- Uses foamy brush handle

|                |                    |       |
|----------------|--------------------|-------|
| <b>\$79.21</b> | <b>F0212PR-XL</b>  | Red   |
| <b>\$80.49</b> | <b>F0212PBL-XL</b> | Blue  |
| <b>\$79.21</b> | <b>F0212PBK-XL</b> | Black |



#### NYLON FOAMY BRUSH WITH ALUMINUM CASTING UNIVERSAL BRUSH

- 9¼" x 2¼" aluminum head
- 2¼" long bristles
- Uses foamy brush handle

|                |                  |             |                |                 |            |                |                 |              |
|----------------|------------------|-------------|----------------|-----------------|------------|----------------|-----------------|--------------|
| <b>\$30.81</b> | <b>F0320NBL</b>  | Blue        | <b>\$30.81</b> | <b>F0320NR</b>  | Red        | <b>\$30.81</b> | <b>F0320NBK</b> | Black        |
| <b>\$23.17</b> | <b>F0320NBLR</b> | Blue Refill | <b>\$23.17</b> | <b>F0318PNR</b> | Red Refill | <b>\$23.17</b> | <b>F0315PNR</b> | Black Refill |

### BRUSH AND BUMPER COLOR MATCH



Universal Brush



#### NYLON FOAMY BRUSH WITH PLASTIC HEAD UNIVERSAL BRUSH

- 9¼" x 2¼" plastic head
- 2 ¼" long bristles
- Uses foamy brush handle

|                |                |                                  |                |                  |              |
|----------------|----------------|----------------------------------|----------------|------------------|--------------|
| <b>\$29.64</b> | <b>F0315PN</b> | Blue Plastic head - Black Brush  | <b>\$23.17</b> | <b>F0315PNR</b>  | Black Refill |
| <b>\$29.64</b> | <b>F0316PN</b> | Blue Plastic Head - Blue Brush   | <b>\$23.17</b> | <b>F0318PNR</b>  | Red Refill   |
| <b>\$29.64</b> | <b>F0317PN</b> | Black Plastic Head - Black Brush | <b>\$23.17</b> | <b>F0320NBLR</b> | Blue Refill  |
| <b>\$29.64</b> | <b>F0318PN</b> | Red Plastic Head - Red Brush     |                |                  |              |



Universal Brush

# BAY ACCESSORIES

## UNIVERSAL BRUSH



### HOGS HAIR TRIPLE SURFACE FOAM BRUSH WITH SIDES

UNIVERSAL BRUSH

Universal Brush

- Fits in 5 gallon bucket
- Use with foamy brush handle - requires FO204A adapter

|                 |               |          |
|-----------------|---------------|----------|
| <b>\$107.56</b> | <b>FO1808</b> | Brush    |
| <b>\$7.65</b>   | <b>FO204A</b> | Adapater |



### BOARTEX ULTRA WASH BRUSH WITH SIDES

UNIVERSAL BRUSH

Universal Brush

- 3" bristle length
- Specialized synthetic Noghair bristles
- Use with foamy brush handle - requires FO204A adapter

|                |                   |          |
|----------------|-------------------|----------|
| <b>\$31.75</b> | <b>FO1808-BTX</b> | Brush    |
| <b>\$7.65</b>  | <b>FO204A</b>     | Adapater |



### 8" HEAD FEATHER TIP TRIPLE SURFACE XL FOAM BRUSH WITH SIDES

UNIVERSAL BRUSH

Universal Brush

- Fits in 5 gallon bucket
- Use with foamy brush handle - requires FO204A adapter

|                |                 |          |
|----------------|-----------------|----------|
| <b>\$20.12</b> | <b>FO1808G</b>  | Green    |
| <b>\$20.12</b> | <b>FO1808R</b>  | Red      |
| <b>\$20.12</b> | <b>FO1808BL</b> | Blue     |
| <b>\$7.65</b>  | <b>FO204A</b>   | Adapater |



### HOGS HAIR BRUSH WITH BUMPER AND ALUMINUM CASTING

UNIVERSAL BRUSH

Universal Brush

- 4" long bristles
- 9¼" x 2¼" head
- Uses foamy brush handle

|                |                |               |
|----------------|----------------|---------------|
| <b>\$65.70</b> | <b>FO194AH</b> | Red Bumper    |
| <b>\$65.70</b> | <b>FO195AH</b> | Blue Bumper   |
| <b>\$65.70</b> | <b>FO196AH</b> | Black Bumper  |
| <b>\$65.70</b> | <b>FO198AH</b> | Yellow Bumper |
| <b>\$65.70</b> | <b>FO199AH</b> | Green Bumper  |
| <b>\$65.70</b> | <b>FO193AH</b> | Purple Bumper |
| <b>\$51.17</b> | <b>FO198HR</b> | Refill        |



### HOGS HAIR WITH PLASTIC HEAD

UNIVERSAL BRUSH

Universal Brush

- 4" long bristles
- 9¼" x 2¼" plastic head
- Uses foamy brush handle

|                |                  |            |
|----------------|------------------|------------|
| <b>\$64.54</b> | <b>FO197PHBK</b> | Black Head |
| <b>\$64.54</b> | <b>FO197PHR</b>  | Red Head   |
| <b>\$64.54</b> | <b>FO198PH</b>   | Blue Head  |
| <b>\$51.17</b> | <b>FO198HR</b>   | Refill     |



### NYLEX FOAMING BRUSH

UNIVERSAL BRUSH

Universal Brush

- Uses foamy brush handle

|                |                   |       |
|----------------|-------------------|-------|
| <b>\$32.93</b> | <b>F088BNX-BK</b> | Black |
| <b>\$32.93</b> | <b>F088BNX-BL</b> | Blue  |
| <b>\$32.93</b> | <b>F088BNX-GR</b> | Green |
| <b>\$32.93</b> | <b>F088BNX-R</b>  | Red   |



### ROUND HOGS HAIR

UNIVERSAL BRUSH

Universal Brush

- 4" long bristles
- 5½" diameter head
- Refills not available
- Uses foamy brush handle

|                |                 |       |
|----------------|-----------------|-------|
| <b>\$80.24</b> | <b>FORNDH</b>   | Blue  |
| <b>\$80.24</b> | <b>FORNDHBK</b> | Black |
| <b>\$80.24</b> | <b>FORNDHR</b>  | Red   |



### ROUND TIRE BRUSH WITH RED PLASTIC HEAD

UNIVERSAL BRUSH

Universal Brush

- 2" stiffer bristles
- 5½" diameter head
- Refills not available
- Uses foamy brush handle

|                |               |
|----------------|---------------|
| <b>\$35.97</b> | <b>FORNDR</b> |
|----------------|---------------|



### ROUND BLACK NYLON BRUSH WITH BLUE PLASTIC HEAD

UNIVERSAL BRUSH

Universal Brush

- Black bristles
- 5½" diameter head
- Refills not available
- Uses foamy brush handle

|                |               |
|----------------|---------------|
| <b>\$35.97</b> | <b>FORNDN</b> |
|----------------|---------------|



### ROUND BLUE NYLON BRUSH WITH BLUE PLASTIC HEAD

UNIVERSAL BRUSH

Universal Brush

- Blue bristles
- 5½" diameter head
- Refills not available
- Uses foamy brush handle

|                |                |
|----------------|----------------|
| <b>\$35.97</b> | <b>FORNDBL</b> |
|----------------|----------------|



# BAY ACCESSORIES

## UNIVERSAL BRUSH

F0400-R

F0400-BL

F0400



### 10" BI-LEVEL FEATHER TIP BRUSHES UNIVERSAL BRUSH



Universal Brush

- Dual surface brushes feature a split brush shape with two position bristle trim
- 10" solid foam block with a threaded handle hole.

|                |                |       |
|----------------|----------------|-------|
| <b>\$18.29</b> | <b>F0400</b>   | Green |
| <b>\$18.29</b> | <b>F0400-R</b> | Red   |

|                |                 |      |
|----------------|-----------------|------|
| <b>\$18.29</b> | <b>F0400-BL</b> | Blue |
|----------------|-----------------|------|



### 10" BI-LEVEL HOGS HAIR BRUSH UNIVERSAL BRUSH



Universal Brush

|                |              |
|----------------|--------------|
| <b>\$82.55</b> | <b>F0403</b> |
|----------------|--------------|



### TRIPLE SURFACE HOGS HAIR UNIVERSAL BRUSH



Universal Brush

- Extra wide coverage means less prep time. Hog filled sides for extra protection

|                 |               |
|-----------------|---------------|
| <b>\$110.00</b> | <b>F01800</b> |
|-----------------|---------------|



### WHEEL BRUSH UNIVERSAL BRUSH



Universal Brush

- Uses broom handle

|                |              |
|----------------|--------------|
| <b>\$12.96</b> | <b>F0332</b> |
|----------------|--------------|



### 10" HOGS HAIR TRUCK BRUSH UNIVERSAL BRUSH



Universal Brush

- Uses broom handle
- Heavy-duty head

|                |              |
|----------------|--------------|
| <b>\$62.79</b> | <b>F0330</b> |
|----------------|--------------|



### 10" HOGS HAIR WITH BUMPER UNIVERSAL BRUSH



Universal Brush

- Prep brush

|                |              |
|----------------|--------------|
| <b>\$62.80</b> | <b>F0103</b> |
|----------------|--------------|



### 10" GREEN BRISTLE BRUSH WITH SOFT BUMPER UNIVERSAL BRUSH



Universal Brush

- Light green bristles
- Feather tip ends
- Soft bumper wraps around top of brush

|                |              |
|----------------|--------------|
| <b>\$12.79</b> | <b>F0101</b> |
|----------------|--------------|



### 10" SYNTHETIC BRUSH WITH FEATHER TIP ENDS UNIVERSAL BRUSH



Universal Brush

- Uses broom handle
- Heavy-duty head

|                |               |
|----------------|---------------|
| <b>\$13.41</b> | <b>F0202Y</b> |
|----------------|---------------|



### ROUND PREP BRUSH UNIVERSAL BRUSH



Universal Brush

- Soft, natural hog's hair
- Great for rims and tires
- Safe, scratch-free washing

|                 |               |
|-----------------|---------------|
| <b>\$114.64</b> | <b>F01600</b> |
|-----------------|---------------|

# BAY ACCESSORIES

## UNIVERSAL BRUSH



**STACK BRUSH**  
UNIVERSAL BRUSH



- Uses broom handle

**\$23.17** BRSTACK



**5" ROUND UPHOLSTERY BRUSH**  
UNIVERSAL BRUSH



- Clean auto upholstery and headliners

**\$23.78** F0901



**5" WHEEL APPLICATOR BRUSH**  
UNIVERSAL BRUSH



- Crimped flagging holds tire cleaner better than standard brushes!

**\$13.78** F01105



**5" NYLON WHEEL & TIRE BRUSH**  
UNIVERSAL BRUSH



- 5" red nylon. GREAT for tires & rims. One standard threaded hole means no more bending over!

**\$9.88** F01104



**7" TOOTHBRUSH STYLE BRUSHES**  
UNIVERSAL BRUSH



- Perfect for the general cleaning of small parts and detail finishing areas!

|               |               |                 |
|---------------|---------------|-----------------|
| <b>\$2.37</b> | <b>F01300</b> | Stainless Steel |
| <b>\$2.37</b> | <b>F01301</b> | Brass           |
| <b>\$2.37</b> | <b>F01302</b> | Horsehair       |



**SPARE PARTS**  
UNIVERSAL BRUSH



|               |                |                  |               |                 |                      |
|---------------|----------------|------------------|---------------|-----------------|----------------------|
| <b>\$9.83</b> | <b>F0193AC</b> | Aluminum Casting | <b>\$8.09</b> | <b>F0193G</b>   | Green Bumper         |
| <b>\$8.09</b> | <b>F0193BL</b> | Blue Bumper      | <b>\$8.09</b> | <b>F0193PR</b>  | Purple Bumper        |
| <b>\$8.09</b> | <b>F0193BK</b> | Black Bumper     | <b>\$9.00</b> | <b>F0193PC</b>  | Blue Plastic Casting |
| <b>\$8.09</b> | <b>F0193R</b>  | Red Bumper       | <b>\$9.00</b> | <b>F0193PCR</b> | Red Plastic Casting  |
| <b>\$8.09</b> | <b>F0193Y</b>  | Yellow Bumper    | <b>\$0.74</b> | <b>F0194US</b>  | Bolts for Brush      |



**FOAM BRUSH WITH NYLON-TYPE SYNTHETIC BRISTLES**  
BOARTEX FOAMY BRUSHES



- Synthetic hogs hair bristles
- One-piece bumper
- Uses foamy brush handle

**\$35.90** BRB2000

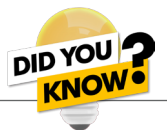

Universal Brush takes great pride in continuing to manufacture all of its products here in the USA!

Universal Brush has distinguished itself over the years as a trusted and dependable supplier to the car wash industry by offering the highest quality, most reliable and consistent products at a fair price.

# BAY ACCESSORIES

## ERIE FOAMMASTER® BRUSHES



### FOAMMASTER® LIGHTWEIGHT HOGS HAIR BRUSH WITH 3¼" BRISTLES ERIE BRUSH



- 10" wide
- Uses foamy brush handle
- Blue bumper

|                |                 |                    |                |                 |                     |
|----------------|-----------------|--------------------|----------------|-----------------|---------------------|
| <b>\$50.66</b> | <b>EB212641</b> | Aluminum Head      | <b>\$44.52</b> | <b>EB212683</b> | ¾" Hogs Hair Refill |
| <b>\$50.66</b> | <b>EB212651</b> | Black Plastic Head |                |                 |                     |



### FOAMMASTER® HOGS HAIR BRUSH WITH 4½" BRISTLES ERIE BRUSH



- 10" wide
- Uses foamy brush handle

|                |                 |                              |                |                 |                             |
|----------------|-----------------|------------------------------|----------------|-----------------|-----------------------------|
| <b>\$77.25</b> | <b>EB212370</b> | Aluminum Head - Black Bumper | <b>\$77.25</b> | <b>EB212570</b> | Plastic Head - Black Bumper |
| <b>\$77.25</b> | <b>EB212371</b> | Aluminum Head - Blue Bumper  | <b>\$77.25</b> | <b>EB212571</b> | Plastic Head - Blue Bumper  |
| <b>\$71.54</b> | <b>F0199PHR</b> | 4½" Hogs Hair Refill         |                |                 |                             |



### FOAMMASTER® HOGS HAIR BRUSH WITH 4" BRISTLES ERIE BRUSH



- 10" wide
- Uses foamy brush handle

|                |                 |                                   |                |                  |                              |
|----------------|-----------------|-----------------------------------|----------------|------------------|------------------------------|
| <b>\$64.31</b> | <b>F0202PH</b>  | Black Plastic Head - Black Bumper | <b>\$64.89</b> | <b>F0202AH</b>   | Aluminum Head - Black Bumper |
| <b>\$64.31</b> | <b>EB212501</b> | Black Plastic Head - Blue Bumper  | <b>\$64.89</b> | <b>F0202AHBL</b> | Aluminum Head - Blue Bumper  |
| <b>\$64.31</b> | <b>EB212502</b> | Black Plastic Head - Red Bumper   | <b>\$64.89</b> | <b>F0202AHR</b>  | Aluminum Head - Red Bumper   |
| <b>\$61.59</b> | <b>F0203HR</b>  | 4" Hogs Hair Refill               |                |                  |                              |



### FOAMMASTER® BLACK PLASTIC HEAD WITH NYLON 2½" BRISTLES ERIE BRUSH



- 10" wide
- Uses foamy brush handle

|                |                 |  |
|----------------|-----------------|--|
| <b>\$28.88</b> | <b>F0205PBL</b> | Black Plastic Head - Blue Bumper - Blue Bristles   |
| <b>\$28.88</b> | <b>F0205PR</b>  | Black Plastic Head - Red Bumper - Red Bristles     |
| <b>\$28.88</b> | <b>F0205PBK</b> | Black Plastic Head - Black Bumper - Black Bristles |



### FOAMMASTER® ALUMINUM HEAD WITH NYLON 2½" BRISTLES ERIE BRUSH



- 10" wide
- Uses foamy brush handle

|                |                 |                               |
|----------------|-----------------|-------------------------------|
| <b>\$28.88</b> | <b>F0205ABL</b> | Blue Bristles - Blue Bumper   |
| <b>\$28.88</b> | <b>F0205AR</b>  | Red Bristles - Red Bumper     |
| <b>\$28.88</b> | <b>F0205ABK</b> | Black Bristles - Black Bumper |



### FOAMMASTER® NYLON REFILLS WITH NYLON 2½" BRISTLES ERIE BRUSH



- Uses foamy brush handle

|                |                 |              |
|----------------|-----------------|--------------|
| <b>\$20.57</b> | <b>F0206RBL</b> | Blue Refill  |
| <b>\$20.57</b> | <b>F0206RR</b>  | Red Refill   |
| <b>\$20.57</b> | <b>F0206RBK</b> | Black Refill |

# BAY ACCESSORIES

## ERIE FOAMMASTER® BRUSHES



### ROUND FOAMMASTER® HOGS HAIR BRUSH 6" DIAMETER

ERIE BRUSH

- Uses foamy brush handle
- Black plastic head

|                |                 |                 |
|----------------|-----------------|-----------------|
| <b>\$80.68</b> | <b>EB21930B</b> | 4" Bristles     |
| <b>\$96.56</b> | <b>EB21959</b>  | 4.75" Hogzilla™ |



### ROUND FOAMMASTER® NYLON BRUSH 6" DIAMETER

ERIE BRUSH

- Uses foamy brush handle
- Black plastic head

|                |                 |                  |
|----------------|-----------------|------------------|
| <b>\$29.58</b> | <b>EB21960</b>  | Black 2.5" Brush |
| <b>\$29.58</b> | <b>EB219620</b> | Blue 2.5" Brush  |
| <b>\$34.93</b> | <b>EB219621</b> | Blue 1.75" Brush |
| <b>\$29.58</b> | <b>EB219640</b> | Red 2.5" Brush   |



## ERIE FOAM BRUSH REPLACEMENT PARTS



### ALUMINUM CASTING

ERIE FOAM BRUSH REPLACEMENT PARTS

|               |                |
|---------------|----------------|
| <b>\$8.86</b> | <b>F0208AC</b> |
|---------------|----------------|



### BLACK PLASTIC CASTING

ERIE FOAM BRUSH REPLACEMENT PARTS

|               |                |
|---------------|----------------|
| <b>\$8.86</b> | <b>F0208PC</b> |
|---------------|----------------|



### RUBBER BUMPER

ERIE FOAM BRUSH REPLACEMENT PARTS

|               |                |       |
|---------------|----------------|-------|
| <b>\$3.94</b> | <b>F0207BL</b> | Blue  |
|               | <b>F0207R</b>  | Red   |
|               | <b>F0207BK</b> | Black |



### SCREWS

ERIE FOAM BRUSH REPLACEMENT PARTS

|               |                 |                        |
|---------------|-----------------|------------------------|
| <b>\$1.68</b> | <b>F0209ESA</b> | SHORT - Aluminum Heads |
| <b>\$0.62</b> | <b>F0209ESP</b> | LONG - Plastic Heads   |



## ERIE BRUSH HOGZILLA™ BRUSH



### HOGZILLA™ HOGS HAIR BRUSH WITH 4¾" BRISTLES

ERIE BRUSH

- 10" Wide
- Uses foamy brush handle

|                |                 |                              |
|----------------|-----------------|------------------------------|
| <b>\$80.58</b> | <b>EB212390</b> | Aluminum Head - Black Bumper |
| <b>\$80.58</b> | <b>EB212391</b> | Aluminum Head - Blue Bumper  |
| <b>\$80.59</b> | <b>EB212590</b> | Plastic Head - Black Bumper  |
| <b>\$74.97</b> | <b>EB212790</b> | 4¾" Hogs Hair Refill         |



## ERIE BRUSH



### TRIPLE SURFACE BI-LEVEL WITH SQUEEGEE 10" WIDE

ERIE BRUSH

- Uses broom handle

|                 |                 |                            |
|-----------------|-----------------|----------------------------|
| <b>\$29.93</b>  | <b>EB224921</b> | 2.5" Bristle - Green Nylon |
| <b>\$111.95</b> | <b>EB224906</b> | 4" Bristle Hogs Hair       |



# BAY ACCESSORIES

## ERIE BRUSH



**HOGS HAIR TRIPLE SURFACE BI-LEVEL BRUSH**  
ERIE BRUSH

- Uses broom handle
- 10" Wide
- 4" Bristles

**\$117.34** F0220



**BLACK & WHITE FEATHER TIP BI-LEVEL BRUSH**  
ERIE BRUSH

- Uses broom handle
- 10" Wide
- 2.5" Styrene Bristles

**\$16.64** F0204



**HI-LO SOFT SIDER HOGS HAIR BRUSH**  
ERIE BRUSH

- 10" Block

**\$156.08** EB226127



**HI-LO SOFT SIDER HOGS HAIR BRUSH**  
ERIE BRUSH

- 4 1/4" Bristle
- 5" Block

**\$101.96** EB226514



**HOGS HAIR TRUCK BRUSH WITH BUMPER**  
ERIE BRUSH

- 10" wide
- 4" Bristle
- Uses broom handle

**\$88.51** EB23350



**ALL AROUNDER® HOGS HAIR BRUSH**  
ERIE BRUSH

- Genuine hogs hair bristle fill
- Acme female thread hole - no handle included

**\$143.32** EB259580



**FEATHER TIPPED TRUCK BRUSH NO BUMPER**  
ERIE BRUSH

- 10" wide
- Uses broom handle

**\$14.02** EB232650



**EQUIPMENT/WALL POLY BRUSH**  
ERIE BRUSH

- 9" wide
- 2.5 bristle
- Uses broom handle

**\$12.61** EB245570



**NYLON TRIPLE SURFACE BI-LEVEL BRUSHES**  
ERIE BRUSH

- Uses broom handle
- 10" Wide
- 2 1/2" Bristle

**\$25.69** EB225200 Green Nylon  
**\$33.70** EB225301 Blue Nylon



**WHEEL WIZARD®**  
ERIE BRUSH

- Uses broom handle

**\$34.14** EB47700 Hogs Hair  
**\$15.57** EB47530 Red Nylon  
**\$15.57** EB47540 Green Nylon  
**\$15.57** EB47520 Blue Nylon



**18" FEATHER TIPPED BRUSH**  
ERIE BRUSH

**\$37.24** EB224300



## ERIE BRUSH - SPOKE BRUSHES



**ULTRA CLOTH SPOKE BRUSH**  
ERIE BRUSH

**\$9.72** EB275550 11"  
**\$11.40** EB275580 16"



**TAMPICO SPOKE BRUSH**  
ERIE BRUSH

**\$3.56** EB27451 10"  
**\$5.19** EB27450 16"





# BAY ACCESSORIES

## HOGS HAIR FOAMY BRUSHES

New!



INSERT

### BUBBLE BRUSH

INKFISH



- Designed for self-serve foaming brush applications. Its curved head reaches corners and other hard to reach areas. Made with premium hog's hair that won't scratch paint.
- Black Color Block/ 3.75" Length
- Over 200 Holes filled with Premium Hogs Hair
- Ships with an insert that adds strength to the connection for the flow thru handle

|                |                  |       |
|----------------|------------------|-------|
| <b>\$89.99</b> | <b>BR1020-BK</b> | Black |
|----------------|------------------|-------|

### ROUND HOGS HAIR FOAMY BRUSH WITH REPLACEABLE HEAD

INKFISH



- This round 4" foamy brush boasts genuine hog hair bristles with naturally feathered ends
- Soft rubber bumper gasket, a brass NPT thread, and a recessed hex screw on the top
- Modular design that allows for replacement brush cartridges
- 6" Diameter head with 4" bristles

#### REMOVING & REPLACING THE CARTRIDGE:

- Use an Allen wrench to gently turn the hex screw one or two rotations (do not remove)
- Grab the bristles with one hand and the head with the other hand and spin the cartridge to the left (left if you're looking from the bottom of the brush)
- Remove the cartridge and replace with new cartridge. Spin into place
- Once cartridge is even around the edges and snugly in place, gently turn the hex screw. Do not over-tighten

|                |                  |                       |
|----------------|------------------|-----------------------|
| <b>\$51.99</b> | <b>BR1016-BK</b> | Black                 |
| <b>\$51.99</b> | <b>BR1016-BL</b> | Blue                  |
| <b>\$41.99</b> | <b>BR1016-RC</b> | Replacement Cartridge |

REPLACEABLE HEAD!



### HOG DADDY 4" HOGS HAIR FOAMY BRUSH

KLEEN-RITE



- High-quality Hog Daddy hogs' hair is durable, yet soft on car surfaces.
- Excellent water-holding ability while retaining stiffness.
- One-piece construction. Meaning, no worrying about accidental insert separation causing a poor wash.
- With no nylon or synthetic bristles, HogDaddy is ideal for clear coats, gel coats, glass, plexiglass, and chrome!
- Low shedding during use.

|                |                   |            |
|----------------|-------------------|------------|
| <b>\$56.50</b> | <b>KRV1102-BL</b> | Blue Head  |
| <b>\$56.50</b> | <b>KRV1102-R</b>  | Red Head   |
| <b>\$56.50</b> | <b>KRV1102-BK</b> | Black Head |

### HOG KING 4.5" HOGS HAIR BRUSHES

KLEEN-RITE



- Aluminum Head: Added durability to withstand a variety of conditions
- Soft Rubber Bumper: Bumper gasket to protect your brush subject from scratches or scrapes
- 4.5" Long Hog's Hair Bristles: Smoothly guides foam across brushing area
- Stainless Steel Plate Screws: Great stability for full control

|                |                  |       |
|----------------|------------------|-------|
| <b>\$61.25</b> | <b>KRV1100R</b>  | Red   |
| <b>\$61.25</b> | <b>KRV1100BL</b> | Blue  |
| <b>\$61.25</b> | <b>KRV1100</b>   | Black |



# BAY ACCESSORIES

## VALUE LINE BRUSHES



### EAR STYLE HOGS HAIR BRUSH VALUE LINE BRUSHES



- Approx. 4.5" brush hair length
- 8" rubber bumper head
- Ear style brush
- Naturally feathered hairs
- Maximum density for ensuring prolonged usage and extra protection

**\$86.99**    **KRV1125**



### TRIPLE SIDED HOGS HAIR BRUSH VALUE LINE BRUSHES



- A cost-effective tool for getting the job done right! Authentic hog's hair fibers facilitate an easier detailing process with no scratching
- Approx. 4.5" brush hair length
- 9.5" rubber bumper head
- Triple sided for more coverage
- Naturally feathered hairs ensure no surfaces or paint finishes are scratched
- Maximum density for ensuring prolonged usage and extra protection

**\$91.75**    **KRV1120**

## BENEFITS OF HOGS HAIR BRUSHES:

- Naturally tapered shape. The base of the bristle is thicker than the end, increasing strength and longevity.
- Maintain shape. Return to original shape when bent or manipulated, ensuring a long life.
- Naturally feathered bristle ends. Hogs hair provides a soft touch that will not damage clear coats, gel coats, glass, or fiberglass.
- Accumulate virtually no grit. Hog filaments are excellent at absorbing water without grabbing grit.
- Real hair is naturally resistant to oil and grease.
- Handmade. Each group of hog hair filaments is manually added to the brush. This adds to the quality construction of the brush.

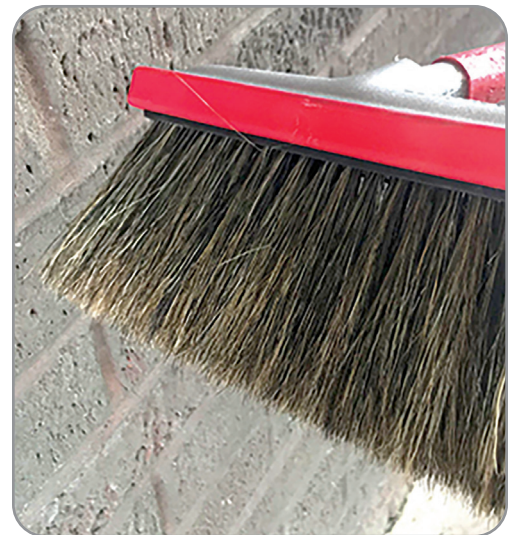

Reorder Quick Order Favorites (0) Rewards My Account Login 866.876.5172

**KLEEN-RITE** CORP. YOUR RELIABLE SUPPLIER FOR THE CAR WASH INDUSTRY

Shop All Pumps Pump Accessories Vending & Retail Bay Accessories Detailing Supplies Hose & Fittings Pressure Washing Soaps & Chemicals Vacuums Valves & Swivels

Kleen-Rite Loyalty Rewards Program

**KLEEN-RITE** **REWARDS** Club

**JOIN THE CLUB!**

Get rewarded for your purchases when you join the FREE Kleen-Rite Rewards Club! For every dollar that you spend, earn 10 points. Redeem your points for great perks like complimentary shipping and special savings.

My Cart \$6.00

Search

Chat

## WHY NOT EARN POINTS WHEN SHOPPING WITH US?!

**Check out our rewards page and how our point system works.**

**Earn and save on our website or the through the app.**

# BAY ACCESSORIES

## PREP BRUSHES



### WASH BRUSHES HARPER BRUSH

**HARPER**

- Uses broom handle

|                |               |                             |
|----------------|---------------|-----------------------------|
| <b>\$19.36</b> | <b>LT1100</b> | 10" blue nylux with bumper  |
| <b>\$15.03</b> | <b>LT1102</b> | 10" synthetic salt & pepper |
| <b>\$20.29</b> | <b>LT8150</b> | 14" truck brush w/o bumper  |



### 8" GRAY SOFT GONG BRUSH HARPER® BRUSHES

**HARPER**

**\$5.96** LT8472



### 10" BI-LEVEL BRUSH HARPER® BRUSH

**HARPER**

- Uses broom handle

**\$18.14** LT1500



### 20" GRAY SOFT GONG BRUSH HARPER BRUSHES

**HARPER**

**\$8.53** LT8572



### TAMPICO WHITE WALL & TIRE BRUSH WEILER BRUSH

**WEILER**

- These brushes are well-suited for light duty applications and greater flexibility. They can be used for delicate, scratch-free brushing

**\$4.31** BR0150 8 1/2" **\$6.34** BR0152 20"



### 20" PALMYRA WHITE WALL & TIRE BRUSH WEILER® BRUSH

**WEILER**

- For general scrubbing in factories, kitchens, institutions, etc.

**\$5.43** BR0158

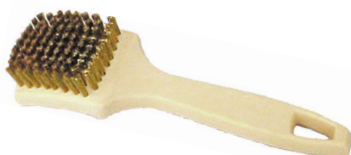

### WHITE WALL & TIRE BRUSH WEILER® BRUSH

**WEILER**

- Brass bristle, foam block

**\$6.08** BR0165



### 10" GRAY SCHOOL BUS BRUSH WEILER® BRUSH

**WEILER**

- Uses broom handle
- Hardwood block top

**\$7.46** BR0105



### 10" HEAVY DUTY TRUCK BRUSH WEILER® BRUSH

**WEILER**

- Uses broom handle
- Protective bumper
- Foam block with two handle holes

**\$14.76** BR0106 Green  
**\$14.90** BR0108 White



### BI-LEVEL GREEN DETAIL BRUSH WEILER® BRUSH

**WEILER**

- Uses foamy brush handle
- Bi-level design allows brush to stay in contact with surface

**\$25.78** BRBL10

# BAY ACCESSORIES

## BRUSH HANDLES



### 6'-12' FIBERGLASS TELESCOPING HANDLE

HARPER BRUSH HANDLES

**HARPER**

- Telescoping handle with heavy duty tip

**\$60.77** LT591



### 5' BLACK COATED 15/16" METAL HANDLE

HARPER BRUSH HANDLES

**HARPER**

- With hang-up swivel

**\$7.47** LT563



### 4' SANDED 7/8" WOOD HANDLE

HARPER BRUSH HANDLES

**HARPER**

- For squeegee

**\$2.39** LT536



### 5' LACQUERED 15/16" WOOD HANDLE

HARPER BRUSH HANDLES

**HARPER**

- With metal Tip

**\$6.67** LT562



### 5' LACQUERED 1 1/8" WOOD HANDLE

HARPER BRUSH HANDLES

**HARPER**

- For squeegee

**\$5.88** LT552

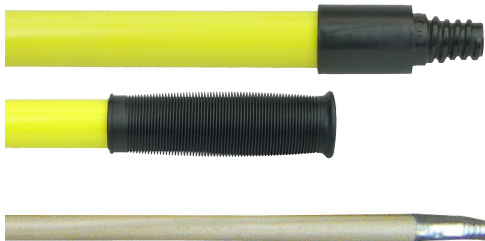

## BRUSH HANDLES

WEILER BRUSH



|                |               |   |
|----------------|---------------|---|
| <b>\$5.09</b>  | <b>BR0201</b> | 4' tapered wooden handle with 15/16" threaded metal tip                                 |
| <b>\$5.36</b>  | <b>BR0212</b> | 5' threaded wooden handle with 15/16" tip   |
| <b>\$15.73</b> | <b>BR0213</b> | 53 1/2" threaded 1" fiberglass handle with honeycomb core - Yellow                      |
| <b>\$4.97</b>  | <b>BR0230</b> | 5' Vortec Pro® metal handle with 15/16" threaded plastic tip and convenient hang-up cap |
| <b>\$7.05</b>  | <b>BR0220</b> | 6' wooden handle with heavy Duty 15/16" threaded metal tip                              |
| <b>\$1.17</b>  | <b>BR0300</b> | Replacement fiberglass handle thread. Fits any 15/16" diameter handle                   |
| <b>\$2.02</b>  | <b>BR0305</b> | Reinforcing steel brace - Locks handle to block - FITS ALL HANDLE SIZES                 |

## AIR SWITCHES & PARTS



### #32 N/O WITH ALUM. BOX AIR SWITCHES

**\$23.12** AS32WB

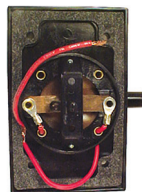

### #32 NORMALLY OPEN AIR SWITCHES

**\$19.67** AS32



### #16 NORMALLY OPEN AIR SWITCHES

**\$15.80** AS16

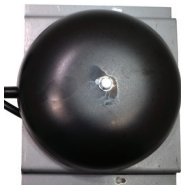

### DRIVEWAY SIGNAL BELL PARTS

**\$53.46** AS10SB



### 3/8" DRIVEWAY BELL HOSE MASTER SIGNAL PARTS

- Per foot • Used with air switch

**\$1.00** H00150



### RUBBER PLUG PARTS

**\$1.25** ASHP



### HOSE SPLICER PARTS

- Connector for 3/8" ID Hose

**\$3.93** AS17

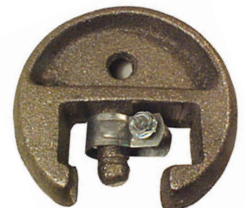

### HOSE ANCHOR PARTS

**\$21.25** AS14

CALIFORNIA PROPOSITION 65 NOTE: some items on this page may fall under the Proposition 65 act. Please consult the State of California Proposition 65 list ([oehha.ca.gov/proposition-65/proposition-65-list](http://oehha.ca.gov/proposition-65/proposition-65-list)) to learn more and to see a comprehensive list of Proposition 65 chemicals.

# BAY ACCESSORIES

## LOCKS



### MEDECO SCREW LOCK LOCKS

- The Medeco unique design provides triple locking action, making the locks virtually pick-proof.
- Fully threaded
- **COMES WITH 1 KEY**

| PRICE   | PART # | SIZE   | FITS                     |
|---------|--------|--------|--------------------------|
| \$60.38 | L00195 | 3"     | Old style Round Monorail |
| \$60.38 | L00197 | 4"     | G-2 Vac                  |
| \$60.38 | L00198 | 4 3/4" | Kleen-Rite 6165 coin box |



### MEDECO CAM LOCK LOCKS

- All Medeco cylinders are constructed of durable machined brass components, designed to last the life of your equipment. Hardened stainless steel inserts inside the cylinder provide the ultimate defense against drilling and other forms of physical attack. Unique elevating and rotation tumbler pin system is virtually pick-proof.
- **COMES WITH 1 KEY**

| PRICE   | PART # | SIZE | DETAILS                 |
|---------|--------|------|-------------------------|
| \$49.79 | L00137 | 5/8" | Fits most coin boxes    |
| \$50.53 | L00138 | 7/8" | Fits Adams Vac Coin Box |



### MEDECO PLUG LOCK LOCKS

- Fits all popular brands of changers and D&S Safes

|         |        |                 |
|---------|--------|-----------------|
| \$38.49 | L00190 | Plug Lock & Key |
| \$33.70 | L00193 | Housing Only    |
| \$11.86 | L00191 | Key Only        |



### MEDECO SWITCH LOCK LOCKS

- This 3/4" diameter switch lock offers a wide range of electrical functions combined with the security and key control of a Medeco cylinder. Great for applications requiring controlled access to electrically activated systems.
- **COMES WITH 1 KEY**

|         |        |
|---------|--------|
| \$62.07 | L00139 |
|---------|--------|



### MEDECO T HANDLE LOCK LOCKS

- Four pin standard
- Dead and spring bolt functions available. 180 degree rotation to open.
- Locks fit all NAMA standard T-handles
- **COMES WITH 1 KEY**

|         |        |
|---------|--------|
| \$43.91 | L00196 |
|---------|--------|



### 6 1/4" GEM SCREW LOCK LOCKS

- Fully threaded, key removable in 4 positions
- **COMES WITH 2 KEYS**
- **MAY BE CUT TO DESIRED LENGTH**

|         |        |
|---------|--------|
| \$21.44 | L00132 |
|---------|--------|



### MONORAIL SWITCH LOCK - OLD STYLE LOCKS

- The Medeco unique design provides triple locking action, making the locks virtually pick-proof.
- Fully Threaded
- **COMES WITH 1 KEY**

|         |         |
|---------|---------|
| \$63.03 | VA30073 |
|---------|---------|



### CAM LOCK GEM LOCKS

- **COMES WITH 2 KEYS**

| PRICE   | PART # | SIZE | DETAILS                 |
|---------|--------|------|-------------------------|
| \$19.82 | L00130 | 5/8" | Fits most coin boxes    |
| \$22.47 | L00134 | 7/8" | Fits Adams Vac Coin Box |

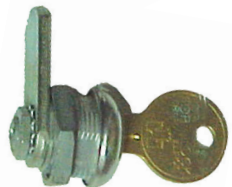

### METER PANEL LOCK LOCKS

- Works great on Industrial and Doyle vacs!
- **COMES WITH 1 KEY**

|         |           |
|---------|-----------|
| \$15.11 | LOI104800 |
|---------|-----------|



### VENDER LOCK LOCKS

- For vender coin box & service lid
- **COMES WITH 2 KEYS**

|        |         |
|--------|---------|
| \$7.67 | LP21133 |
|--------|---------|



### GREENWALD LOCKS LOCKS

- **1 KEY INCLUDED**

|         |          |   |
|---------|----------|---|
| \$19.30 | GR8-55-1 | Lock with Long Key<br>No key number needed  |
| \$27.71 | GR8-1169 | Lock with Short Key<br>No key number needed |

# BAY ACCESSORIES

## LOCKS



COMES WITH 2 KEYS

### 28/70 BUFFALO STAINLESS STEEL LOCK

ABUS LOCKS



- Lock size: 2<sup>3</sup>/<sub>4</sub>"
- Stainless steel construction fights rust and corrosion
- 4-pin cylinder w/anti-pick mushroom pins and bronze spring
- Case hardened shackle extends around the entire case allowing only <sup>3</sup>/<sub>4</sub>" exposed
- Shackle diameter - 13/32"
- Great for self storage units
- Shackle opening- <sup>3</sup>/<sub>4</sub>"W x <sup>3</sup>/<sub>4</sub>"D

\$15.97 L00100

DIFFERENT KEY CODES AVAILABLE - CALL FOR DETAILS



COMES WITH 2 KEYS

### 24/70 STAINLESS STEEL LOCK

ABUS LOCKS



- Lock size: 2<sup>3</sup>/<sub>4</sub>"
- Shackle diameter: 13/32"
- 4-pin cylinder with anti-pick mushroom pins and bronze springs
- Shackle, lock body and all inner components made of non-corrosive stainless steel allowing only <sup>3</sup>/<sub>4</sub>" exposed
- Shackle Opening - <sup>3</sup>/<sub>4</sub>"W x <sup>3</sup>/<sub>4</sub>"D
- Stainless steel - fights against rust and corrosion
- Dust cover over the keyway to keep out harsh elements

\$23.61 L00105

DIFFERENT KEY CODES AVAILABLE - MUST ASSIGN A KEY CODE



COMES WITH 2 KEYS

### 26/90 BIG BOY LOCK

ABUS LOCKS



- Lock Size - 3<sup>3</sup>/<sub>8</sub>"
- Shackle Diameter - 1/2"
- Hardened chrome shackle
- Made of stainless steel with nearly 10,000 lbs. of breaking strength
- Welded armor outer shell and laminated steel core inside combined to create a practically invincible lock
- Shackle Opening - 1"W x <sup>5</sup>/<sub>8</sub>"D
- 5-pin cylinder with anti-pick mushroom pins and bronze springs
- Added improved thicker metal plates to protect from prying and grinding

\$48.40 L00350

DIFFERENT KEY CODES AVAILABLE - MUST ASSIGN A KEY CODE



### 20/70 PICK PROOF LOCK

ABUS LOCKS



- Lock size - 2<sup>3</sup>/<sub>4</sub>"
- Shackle opening- <sup>3</sup>/<sub>4</sub>"W x <sup>3</sup>/<sub>4</sub>"D
- Shackle diameter - 13/32"
- All stainless steel body: INSIDE & OUT
- Hardened shackle w/minimum exposure
- High security 6-Disc Plus cylinder which offers over 30,000 true key differs
- Hardened steel anti-drill cover to protect the cylinder
- **GREAT FOR VENDING MACHINES**

\$38.41 L00300



### 70/45 SERIES SOLID BRASS BODY

ABUS LOCKS



- Hardened steel shackle
- Solid brass body and internal components
- Keyed differently or keyed alike

\$10.65 LOA7045

DIFFERENT KEY CODES AVAILABLE - MUST ASSIGN A KEY CODE



### 55 SERIES SOLID BRASS PADLOCK

ABUS LOCKS



- Great for vac cleanout doors
- 4-pin tumbler security
- Extruded solid brass body
- Chrome plated hardened steel shackle

| 55/60   |         |                                 |   |              |
|---------|---------|---------------------------------|---|--------------|
| PRICE   | PART #  | SIZE                            | SHACKLE OPENING   | SHACKLE DIA. |
| \$12.63 | LOA5560 | 2 <sup>3</sup> / <sub>8</sub> " | 1 <sup>1</sup> / <sub>4</sub> " W x 1 <sup>1</sup> / <sub>4</sub> " D | 5/16"        |

DIFFERENT KEY CODES AVAILABLE - MUST ASSIGN A KEY CODE



### PIN FOR PINLOCK

WILSON BOHANNAN LOCKS

- 1<sup>3</sup>/<sub>4</sub>" long

\$1.41 L00250P



### PIN FOR PINLOCK

LOCKS

- Stainless steel
- Threaded

\$17.13 VA40040



### THREADED WELD NUT

LOCKS

- For lock pin

\$3.87 VA40041

# BAY ACCESSORIES

## LOCKS



### AMERICAN LOCK™ LOCKS

- Patented shackleless lock
- Nothing exposed
- Solid 1 piece case is reinforced with 9 hardened steel pins
- Shackle size: 5/8"H x 13/32"D

**\$29.21**    **LO2000**

**DIFFERENT KEY CODES AVAILABLE -  
MUST ASSIGN A KEY CODE**



### 700 SERIES AMERICAN LOCK™ LOCKS

- 2½" x 1½"
- Thick, case hardened, chrome plated solid steel padlock with Baron shackle

**\$54.68**    **LOAM700**



### SOLID BRASS PINLOCK LOCKS

- Used in coin boxes and vacs
- Pin is 3/8" diameter - Pin sold separately
- One piece solid extruded bronze

|                |                |      |
|----------------|----------------|------|
| <b>\$21.79</b> | <b>L00250</b>  | Lock |
| <b>\$1.41</b>  | <b>L00250P</b> | Pin  |

**DIFFERENT KEY CODES AVAILABLE - MUST ASSIGN A KEY CODE**



### CHINROSE® SOLID STEEL PADLOCK CHINROSE LOCKS

- 2½" (65mm) extra security and hardened steel commercial grade globe shape, heavy-weight padlock
- Available in keyed alike & keyed different

**\$30.24**    **LOC9700**



### CHINROSE® CHROME PLATED PADLOCK CHINROSE LOCKS

- Extra security chrome plated on solid brass padlock with unique dual dimension keys in keyed alike
- Has disc and spacer mechanisms
- Commercial grade
- Available in keyed alike & keyed different

|                |                |            |   |
|----------------|----------------|------------|---|
| <b>\$19.99</b> | <b>LOC5401</b> | 1½" (40mm) | Available in 10 different keyed-alike key cut codes |
| <b>\$25.00</b> | <b>LOC7501</b> | 2" (50mm)  | Available in 20 different keyed-alike key cut codes |



### CHINROSE® GRADE 304 STAINLESS STEEL ROUND DISC LOCK CHINROSE LOCKS

- 2¾" (70mm)
- Commercial grade 5 pin cylinder with 2 keys
- SECURUS® (CHINROSE®)
- Available in keyed different and keyed alike

**\$9.66**    **LOC5000**



### CHINROSE® PATENTED LAMINATED STEEL PADLOCK CHINROSE LOCKS

- Body width: 2" (50mm)
- Patented laminated steel padlock - heavy weight
- Available in keyed different and keyed alike

**\$9.35**    **LOC1500**

**DIFFERENT KEY CODES AVAILABLE -  
MUST ASSIGN A KEY CODE**

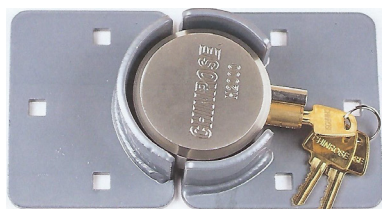

### CHINROSE® HASP FOR HIDDEN SHACKLE PUCK LOCK CHINROSE LOCKS

- Hasp of hardened solid state steel for hidden shackle pad lock
- Side opening only

**\$30.54**    **LOC7000-HS**

**HASP ONLY - LOCK SOLD SEPARATELY -  
LOC7000**



### CHINROSE® HEAVY DUTY GATE HASP CHINROSE LOCKS

- Unique zinc plated solid steel
- Secures 2 gates together or a single gate to a post

**\$22.49**    **LOC5500**

# BAY ACCESSORIES

## SAFES & LOCK ACCESSORIES

### STANDARD TWO NIPPLES

PLATED OR STAINLESS STEEL HEAD

10"  
\$700  
CAPACITY

14"  
\$1,200  
CAPACITY

18"  
\$1,600  
CAPACITY

**PLASTIC COIN TRAYS**  
(STANDARD WITH EACH SAFE)

3/8" HEX 'T'  
WRENCH W/EA SAFE

### ROUND STAINLESS STEEL SAFES

SAFES

- Comes with Allen wrench, coin tray & plated head
- Locks NOT included

| PRICE    | PART #   | SIZE | DESCRIPTION            |
|----------|----------|------|------------------------|
| \$550.55 | CBSR10   | 10"  | w/plated head          |
| \$819.37 | CBSR10S  | 10"  | w/stainless steel head |
| \$654.73 | CBSR14   | 14"  | w/plated head          |
| \$755.37 | CBSR14S  | 14"  | w/stainless head       |
| \$596.46 | CBSR18   | 18"  | w/plated head          |
| \$810.02 | CBSR18S  | 18"  | w/stainless head       |
| \$19.99  | CBS315TH |      | Allen Wrench           |

### ROUND STAINLESS STEEL SAFE HEADS

SAFE PARTS

|          |           |   |
|----------|-----------|---|
| \$307.54 | CBSHPL    | 7" Plated safe head                             |
| \$576.93 | CBSHSS    | 7" Stainless steel safe head                    |
| \$324.68 | CBSHPLTAB | 7" High-security safe heads                     |
| \$346.66 | CBSHSR    | 7½" Diameter star replacement                   |
| \$607.00 | CBSHSSTAB | 7" Stainless steel star safe head with lock tab |

### REPAIR KIT FOR ROUND SAFE HEAD

SAFE PARTS

- Includes spring, ball & cam

**\$48.65** CBSKR08

### COIN TRAYS

SAFE PARTS

| PRICE   | PART #  | TRAY | SAFE SIZE |
|---------|---------|------|-----------|
| \$66.37 | CBSCT10 | 6"   | 10"       |
| \$69.51 | CBSCT14 | 10"  | 14"       |
| \$81.79 | CBSCT18 | 14"  | 18"       |

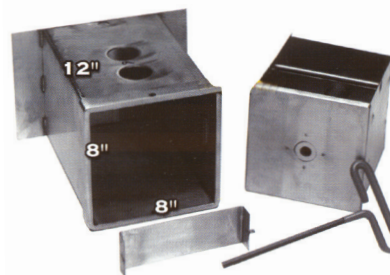

### T-HANDLE SQUARE SAFE

SAFES

- 9" x 9" x 12"
- High security safe
- \$1,000.00 capacity
- Medeco T-Handle lock

| CALL     | PART #  | SAFE                 |
|----------|---------|----------------------|
| \$258.61 | CBS3000 | Safe                 |
| \$217.69 | CBS0650 | Medeco T-Handle Lock |
|          | CBS4001 | Coin Tray            |



### SQUARE SAFES

SAFES

- Comes with Allen wrench, coin tray, & lock bar
- All stainless steel construction
- Use L00190 (Medeco Plug Lock)
- 8" x 12"
- \$750.00 capacity
- Locks NOT included

**\$724.71** CBS609A

### LOCK GUARD

LOCKS

- For Buffo & Abus
- Stainless steel construction

**\$8.46** LG100



### LOCK BARS (1½" WIDE)

SAFE PARTS

| PRICE   | PART #  | DESCRIPTION                       |
|---------|---------|-----------------------------------|
| \$18.54 | CBA9103 | Standard - SS 8¾"                 |
| \$26.34 | CBA9104 | Use with Lock guard - Flat SS 8¾" |
| \$25.99 | CBA9105 | Monorail style - Flat SS 9½"      |
| \$8.46  | LG100   | Lock guard (for Buffo and Abus)   |

### 10 OZ. CAN OF SILICONE LUBRICANT

SAFE ACCESSORIES

- Keeps lock mechanisms lubricated & functioning smoothly

**\$6.88** DD04603



### PLASTIC COIN FUNNEL

SAFE ACCESSORIES

- Wide section O.D.: 4½"
- Small section I.D.: 1¼"
- Small section O.D.: 1⅜"

**\$3.60** GS19028





# BAY ACCESSORIES

## ROTARY SWITCHES

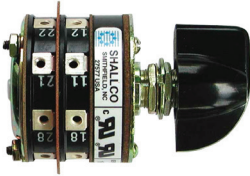

**8 POSITION 2 STACK  
ROTARY SWITCH**  
SHALLCO SWITCHES



**\$28.03** STKR8

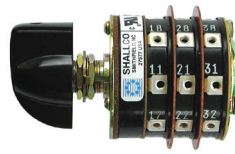

**8 POSITION 3 STACK  
ROTARY SWITCH**  
SHALLCO SWITCHES



**\$34.33** STKR83

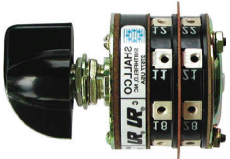

**10 POSITION 2 STACK  
ROTARY SWITCH**  
SHALLCO SWITCHES



**\$67.08** STKR10

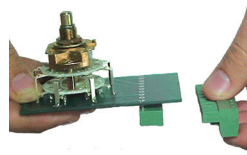

**ELECTRONIC ROTARY SWITCH  
SWITCHES**

- Easy replacement - wire the plug once and simply unplug to replace future switches. Knob sold separately

|                 |              |             |
|-----------------|--------------|-------------|
| <b>\$101.52</b> | <b>STE8</b>  | 8 position  |
| <b>\$122.46</b> | <b>STE10</b> | 10 position |

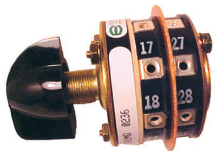

**8 POSITION - 2 STACK**  
ELECTROSWITCH



- Metal construction
- Double-rotary action with plastic knob
- Included all mounting hardware

**\$33.60** ST0209



**8 POSITION - 2 STACK**  
ELECTROSWITCH



- Plastic construction
- Includes all mounting hardware

**\$26.53** ST0216P

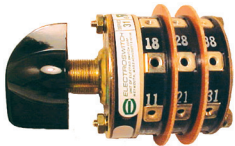

**8 POSITION - 3 STACK**  
ELECTROSWITCH



- Metal construction
- Double-rotary action with plastic knob
- Included all mounting hardware

**\$34.07** ST0210

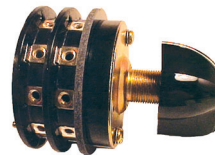

**10 POSITION - 2 STACK**  
ELECTROSWITCH



- Metal construction
- Double-rotary action with plastic knob
- Included all mounting hardware

**\$61.39** ST0215

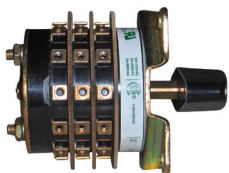

**12 POSITION - 3 STACK**  
ELECTROSWITCH



- Metal construction
- Double-rotary action with plastic knob
- Included all mounting hardware

**\$264.45** ST0213



**12 POSITION - 2 STACK**  
ELECTROSWITCH



- Metal construction
- Double-rotary action with plastic knob
- Included all mounting hardware

**\$122.83** ST0212

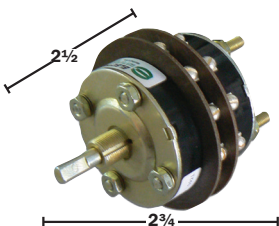

**12 POSITION  
ROTARY SWITCH**  
ELECTROSWITCH



- Makes it easy to upgrade your boxes and add more bay functions
- Direct replacement for both 8 & 10 position.
- \*knobs not included

**\$177.93** ST0214



### HAVE QUESTIONS?

Talk to one of our professional car wash experts live on our website! Just click on the "LIVE CHAT" icon our website to start a conversation TODAY!

# BAY ACCESSORIES

## ROTARY SWITCHES & METERBOX/COINBOX ACCESSORIES



### PS300 PERMASWITCH - ELECTRONIC 10 POSITION ROTARY SWITCH

IDX

- The IDX PS300 Electronic Rotary Switch has ten positions and uses push button operation for self-serve services. The PS300 uses the same front disk (PS200-10) and decals (DECPS200) as the PS200 rotary switch. Changes include a shorter rear box with a 1' long harness that connects to a separate relay box with a 2' connector cable.
- **RELAY BOX DIMENSIONS:** 2.5" H x 3" W x 1" L
- **REAR BOX DIMENSIONS:** 1.75" H x 2.375" W x 2.65" L

**\$415.85** IDXPS300



### PS300 & PS200 PARTS & ACCESSORIES

IDX

**\$29.96**

IDXPS300-UI

Wiring Harness Component

Use with PS300 and older model PS200 electronic rotary switches

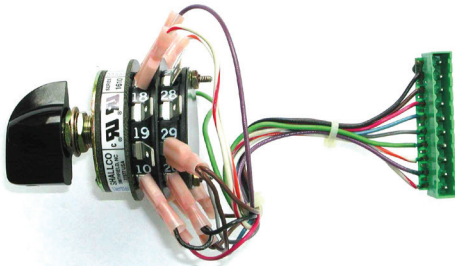

### "Q-C" ROTARY SWITCH

KLEEN-RITE CORP

**KLEEN-RITE**.corp

- Revolutionary design will make changing out rotary switches a breeze! comes complete with wiring harness

**\$66.66**

STKR8QC

8 position - 2 stack

**\$87.27**

STKR10QC

10 position - 2 stack

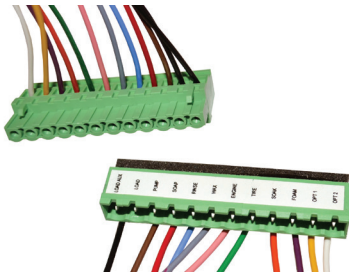

### PARTS FOR STKR10QC

KLEEN-RITE CORP

**KLEEN-RITE**.corp

**\$35.29**

STKR8QC-SWITCH

Switch only for STKR8QC

**\$73.92**

STKR10QC-SWITC

Switch only for STKR10QC

**\$14.06**

STKRP378

Male harness for the STKR10QC

**\$28.19**

STKRP377

Female harness for the STKR10QC

**\$20.11**

STKRP374

Female harness for the STKR8QC

**\$12.94**

STKRP375

Male harness for the STKR8QC



**STANDARD BLACK KNOB WITH 1 SET SCREW**  
ROTARY KNOBS

**\$2.72**

STK211



**HEAVY DUTY YELLOW KNOB WITH 2 SET SCREWS**  
ROTARY KNOBS

**\$4.11**

CBK238



**HEAVY DUTY BLACK KNOB WITH 2 SET SCREWS**  
ROTARY KNOBS

**\$4.52**

CBK238BK

# BAY ACCESSORIES

## METERBOX/COINBOX ACCESSORIES

FEMALE

MALE

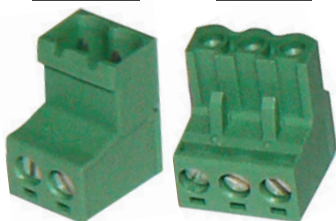

### PHOENIX CONNECTORS

BAY ACCESSORIES

| MALE CONNECTION   |           |        |
|-------------------|-----------|--------|
| \$2.10            | HSEC14825 | 2 Pin  |
| \$3.13            | HSEC14827 | 3 Pin  |
| \$12.54           | HSEC14823 | 12 Pin |
| FEMALE CONNECTION |           |        |
| \$3.46            | HSEC14826 | 2 Pin  |
| \$5.20            | HSEC14828 | 3 Pin  |
| \$20.77           | HSEC14824 | 12 Pin |

### MERCURY RELAYS NORMALLY OPEN

BAY ACCESSORIES



|         |        |           |
|---------|--------|-----------|
| \$35.48 | RLM24  | 24V Coil  |
| \$35.48 | RLM120 | 120V Coil |



### 15 SPACE TERMINAL STRIP

BAY ACCESSORIES

|         |         |
|---------|---------|
| \$14.27 | GS18727 |
|---------|---------|

### COIN BOX PILOT LIGHTS

BAY ACCESSORIES



|        |         |     |        |
|--------|---------|-----|--------|
| \$3.14 | CB0228  | 24V | Red    |
| \$3.14 | CB0228G | 24V | Green  |
| \$3.14 | CB0228Y | 24V | Yellow |

### COIN BOX HEATER ASSEMBLY WITH THERMOSTAT

GINSAN

• 30W

|         |         |
|---------|---------|
| \$63.46 | GS31070 |
|---------|---------|

### COIN BOX HEATER ASSEMBLY WITH THERMOSTAT

GINSAN

• 20W & 30W  
• Also available for Touchtron 2

|         |          |
|---------|----------|
| \$77.18 | GS31070A |
|---------|----------|

**GinSan**  
INDUSTRIES

**GinSan**  
INDUSTRIES

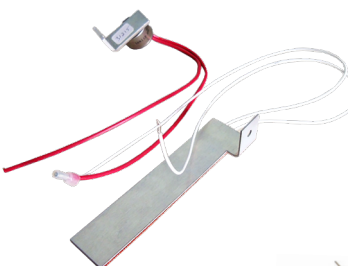

### 24V/30W COIN BOX HEATER WITH BRACKET

GINSAN

|         |         |
|---------|---------|
| \$70.56 | GS18128 |
|---------|---------|

**GinSan**  
INDUSTRIES



### THERMOSTAT FOR 24V HEAT TAPE

BAY ACCESSORIES

|         |         |
|---------|---------|
| \$12.18 | GS28025 |
|---------|---------|

### COIN BOX HEAT TAPE WITH ADHESIVE

BAY ACCESSORIES

|         |        |           |
|---------|--------|-----------|
| \$26.01 | CB0245 | 24V - 40W |
| \$24.09 | CB0237 | 24V - 20W |



### 40 VA - 120 TO 24V TRANSFORMERS

|         |        |
|---------|--------|
| \$32.13 | TR0135 |
|---------|--------|

California Proposition 65



### 100 VA - 120 TO 240 TO 24V TRANSFORMERS

|         |        |
|---------|--------|
| \$59.58 | TR0105 |
|---------|--------|

### 5 AMP FUSE FOR TRANSFORMER

|        |        |
|--------|--------|
| \$4.96 | EL0100 |
|--------|--------|

### CABLE TIES

BAY ACCESSORIES



| PRICE   | PART # | DESCRIPTION                          | WT.    |
|---------|--------|--------------------------------------|--------|
| \$1.80  | TYW4   | 4" Cable Ties - 100/pk               | 18 lb  |
| \$3.16  | TYW5   | 5" Cable Ties - 100/pk               | 30 lb  |
| \$10.38 | TYW7E  | 7" Cable Ties - 100/pk • With Eyelet | 50 lbs |
| \$4.68  | TYW8   | 8" Cable Ties - 100/pk               | 40 lb  |

| PRICE   | PART #    | DESCRIPTION             | WT.    |
|---------|-----------|-------------------------|--------|
| \$7.50  | TYW11     | 11" Cable Ties - 100/pk | 40 lb  |
| \$10.42 | TYW14     | 14" Cable Ties - 100/pk | 40 lb  |
| \$13.79 | TYW14-120 | 15" Cable Ties - 100/pk | 120 lb |
| \$22.81 | TYW24     | 24" Cable Ties - 50/pk  | 175 lb |
| \$18.75 | TYW36     | 36" Cable Ties - 50/pk  | 175 lb |

**MADE IN THE USA**  
**Denco**  
Distributing, Inc.

### RESETTABLE BREAKER

BAY ACCESSORIES

|        |        |        |        |        |        |
|--------|--------|--------|--------|--------|--------|
| \$7.36 | EL0280 | 3 AMP  | \$8.24 | EL0282 | 12 AMP |
| \$8.99 | EL0281 | 5 AMP  | \$6.20 | EL0283 | 15 AMP |
| \$7.19 | EL0285 | 10 AMP | \$6.62 | EL0284 | 20 AMP |



### COIN BOX CONTROL WIRE - STRANDED

BAY ACCESSORIES

• 18 Gauge  
• 20 Conductor  
• Assorted Colors  
• 18 Gauge  
• 15 Conductor  
• Assorted Colors

|                   |                   |
|-------------------|-------------------|
| WI0090            | WI0085            |
| \$2.30 Under 100' | \$1.62 Under 100' |



CALIFORNIA PROPOSITION 65 NOTE: some items on this page may fall under the Proposition 65 act. Please consult the State of California Proposition 65 list ([oehha.ca.gov/proposition-65/proposition-65-list](http://oehha.ca.gov/proposition-65/proposition-65-list)) to learn more and to see a comprehensive list of Proposition 65 chemicals.

# BAY ACCESSORIES

## ELECTRICAL ACCESSORIES



### TERMINAL KIT WITH CASE

DYNATEX

#### 110 PIECE KIT INCLUDES:

- (10) 22-14 gauge blue wire nuts
- (5) 18-12 gauge yellow wire nuts
- (10) Crimp style 22-16 gauge wire nuts
- (5) Male disconnects 22-16 gauge red
- (5) Male disconnect 16-14 gauge blue
- (10) Nylon butt connector 22-18 g red
- (10) Nylon butt connector 21-10 g yellow
- (5) Nylon fork #8 16-14 gauge blue
- (5) 22-14 gauge orange wire nuts
- (5) 18-10 gauge red wire nuts
- (10) Crimp style 16-14 gauge wire nuts
- (5) Female disconnects 22-16 gauge red
- (5) Female disconnect 16-14 gauge blue
- (10) Nylon butt connector 16-14 g blue
- (5) Nylon fork #8 22-18 gauge red
- (5) Nylon fork #8 12-10 gauge yellow

**\$17.32** DD0110



### 5 OZ. DIELECTRIC GREASE

DYNATEX

**\$18.23** DD49635



### 3 OZ. CLEAR SILICONE GASKET MAKER

DYNATEX

**\$6.98** DD49204



### 3 OZ. BLACK SILICONE GASKET MAKER

J-B WELD

**\$6.98** DD49200



### 10 OZ. CLEANERS & LUBRICANTS

JOHNSON'S®

|               |                |                    |
|---------------|----------------|--------------------|
| <b>\$3.50</b> | <b>DD4723</b>  | Chain & Cable Lube |
| <b>\$5.63</b> | <b>DD4607</b>  | Air Duster         |
| <b>\$4.12</b> | <b>DD4600</b>  | Electronic Cleaner |
| <b>\$6.88</b> | <b>DD04603</b> | Silicone Lubricant |



### THREAD LOCKER

DYNATEX

|               |                |                      |
|---------------|----------------|----------------------|
| <b>\$4.57</b> | <b>DD49441</b> | BLUE (med. strength) |
| <b>\$4.57</b> | <b>DD49451</b> | RED (high strength)  |

### SPLIT LOOM

BAY ACCESSORIES

- Ideal for covering wires, hoses, etc.

| PRICE         | PART #        | SIZE          | PRICE          | PART #        | SIZE          |
|---------------|---------------|---------------|----------------|---------------|---------------|
| <b>\$5.97</b> | <b>SWL240</b> | 1/4" SL - 25' | <b>\$10.13</b> | <b>SWL243</b> | 3/4" SL - 25' |
| <b>\$6.71</b> | <b>SWL241</b> | 3/8" SL - 25' | <b>\$18.12</b> | <b>SWL244</b> | 1" SL - 25'   |
| <b>\$7.83</b> | <b>SWL242</b> | 1/2" SL - 25' |                |               |               |



### New! INDUSTRIAL GRADE WATERPROOF 2-WAY RADIO WALKIE TALKIE

MIDLAND

Single 2-way IP67 waterproof walkie talkie with 16 channels. Includes charger, rechargeable battery pack, AC wall adapter, belt clip, and owner's manual. Convenient way to improve communication at your business.

- 10 hours of battery life
- Li-On battery pack with rapid charge
- Easy PC programming with 99 frequency selections
- Diecast metal frame for durability
- Monitor, scan and priority scan
- IP67 rating for water and dust protection
- 4 watts of power
- Radio-to-radio cloning
- 142 privacy codes
- Repeater compatible

|                 |                  |        |
|-----------------|------------------|--------|
| <b>\$129.99</b> | <b>MB400</b>     | Single |
| <b>\$799.99</b> | <b>MB400X6MC</b> | 6-Pack |



### New! TWO-WAY RADIO WALKIE TALKIE- 16 CHANNEL

MIDLAND

2-way durable walkie talkie with 16 channels. Includes charger, rechargeable battery pack, AC wall adapter, belt clip, and owner's manual. Convenient way to improve communication at your business. Single or package of six.

- 21 hours of battery life
- Rechargeable Li-Ion battery
- Monitor and scan functions
- 56 Business specific frequencies
- Easy PC programmable
- Voice prompted battery alert & channel selection

|                 |                   |        |
|-----------------|-------------------|--------|
| <b>\$99.99</b>  | <b>BR200</b>      | Single |
| <b>\$599.99</b> | <b>BR200X6BGC</b> | 6-Pack |



# BAY ACCESSORIES

LOCTITE®



## 12 OZ. ANTI-SEIZE LUBRICANT

LOCTITE

LOCTITE®

- Petroleum based and formulated for super cold atmosphere and high temperatures - up to 1600° F with little to no evaporating or hardening
- Allows easy disassembly of parts
- Great for taking apart stuck/stubborn pieces

**\$11.43** LOC38658



## 16 OZ. RUBBERIZED UNDERCOATING

LOCTITE

LOCTITE®

- Seals, protects, insulates
- 12 per case
- Rubberized for maximum durability

**\$49.61** LOC37580



## 8 OZ. COPPER ANTI-SEIZE LUBRICANT WITH BRUSH TOP

LOCTITE

LOCTITE®

- May be used to prevent seizing, corrosion and galling where high temp. conditions exist
- Temperature range: -30° F to 1800° F
- Provides good electrical conductivity

**\$10.06** LOC38650



## BLUE STICK THREAD LOCKER

LOCTITE

LOCTITE®

- Medium strength anaerobic thread locker offers same locking strength and sealing capabilities as Loctite®'s traditional threadlocking liquid.
- Wax-like stick with a self-feeding applicator
- Well-suited for difficult repairs (like overhead applications)
- Can be applied even if part assembly will occur later - Ideal for volume assembly
- Removable with hand tools

**\$10.66** LOC37643

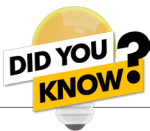

Loctite® products provide solutions for a number of the industry's biggest challenges. Loctite has serviced a number of different industries including aerospace, automotive, electronics, industrial assembly, mechanical repair, and more!

Rely on the Loctite for professional adhesives and lubricants to tackle any application.

**LOCTITE®**

**CALIFORNIA PROPOSITION 65 NOTE:** some items on this page may fall under the Proposition 65 act. Please consult the State of California Proposition 65 list ([oehha.ca.gov/proposition-65/proposition-65-list](http://oehha.ca.gov/proposition-65/proposition-65-list)) to learn more and to see a comprehensive list of Proposition 65 chemicals.

ALL PRICES ARE F.O.B. AND ARE SUBJECT TO CHANGE WITHOUT NOTICE • NO C.O.D.'S

1-800-233-3873 • (717) 684-6721 • FAX (800) 446-0495 • KLEENRITE.COM

413

# BAY ACCESSORIES

## COIN BOX ACCESSORIES



### COINBOX SHELL WITH PUCK LOCKS AND FLEX FACEPLATE FOR DIXMOR TIMER

J.E. ADAMS

- 13.00"W x 17.00"H x 8.50"D
- Coin Box Sold Separately (CBA8799-6005A)
- Flex faceplate can accommodate: Dixmor LED7, Coin Mechanism, Bill Validator, CryptoPay or Nayax
- Includes 2 Puck Locks
- No decal
- No internal components

**\$1,256.25** CBA19250



### UNIVERSAL DIXMOR COIN BOX

J.E. ADAMS

- For CBA19250 coinbox and the 8799 Series Digital Air & Air/Water machines (non-vault ready)
- 6" x 4.75" x 4.5"
- Holds \$224.00

**\$47.50** CBA8799-6005A

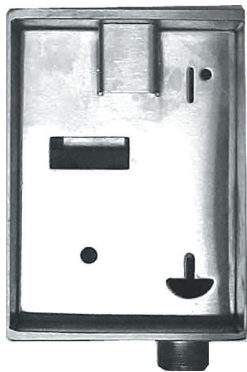

### STAINLESS STEEL VAULT-READY COIN BOX 6058 WITHOUT LOCKS

J.E. ADAMS

- Stainless steel pin lock style stationary pin
- This 10 gauge box is made to be vault-ready and features a face plate with 1½" stainless steel nipple
- 7¼" W x 7½" D x 10½"H

**\$273.68** CBA6055



### STAINLESS STEEL PINLOCK STYLE COINBOX

J.E. ADAMS

- Stationary pin
- 10 gauge box and face plate, money box & shell
- 7¼"W x 7½"D x 15½"H

|                 |                 |                          |
|-----------------|-----------------|--------------------------|
| <b>\$352.40</b> | <b>CBA6070</b>  | with Standard Faceplate  |
| <b>\$352.40</b> | <b>CBA6070D</b> | with Dixmor Faceplate    |
| <b>\$26.34</b>  | <b>CBA9104</b>  | Stainless Steel Lock Bar |
| <b>\$25.15</b>  | <b>CBD610</b>   | Red Decal                |



### STAINLESS STEEL CAM & SCREW LOCK STYLE COIN BOX

J.E. ADAMS

- Cam lock face plate
- 10 gauge stainless steel shell
- 12 gauge face plate
- 7¼"W x 7½"D x 15¼"H

|                 |                |                   |
|-----------------|----------------|-------------------|
| <b>\$341.60</b> | <b>CBA6165</b> | Coinbox           |
| <b>\$26.34</b>  | <b>CBA9104</b> | Optional Lock Bar |

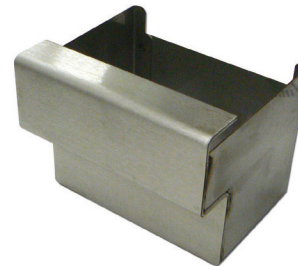

### 8204RW COIN BOX REPLACEMENT FOR VACUUMS

J.E. ADAMS

- For CBA6055 & CBA6070 + many J.E. Adams models - see website for complete details
- 5.772"H x 6.938"W x 6.120"D
- Hold 940 quarters or \$235.00

**\$95.16** CBA8204

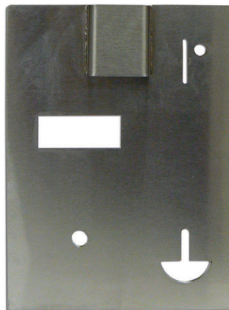

### FACEPLATES

J.E. ADAMS

- For CBA6055 & CBA6070

|                |                |                           |
|----------------|----------------|---------------------------|
| <b>\$66.67</b> | <b>CBA8211</b> | Plain Faceplate           |
| <b>\$58.97</b> | <b>CBA6068</b> | Digital Readout Faceplate |



### STAINLESS STEEL PUCK LOCK STYLE COIN BOX

J.E. ADAMS

- Features American 2000 puck lock
- Cam lock for faceplate
- 10 gauge stainless steel construction
- 7¼"W x 7½"D x 15¼"H

|                 |                 |                          |
|-----------------|-----------------|--------------------------|
| <b>\$512.39</b> | <b>CBA6175</b>  | Standard                 |
| <b>\$518.50</b> | <b>CBA6175D</b> | With Dixmor Timer Cutout |

**CVA6175**

# KLEEN-RITE COINBOXES

**Kleen-Rite coin boxes deliver reliable money acceptance and function control, perfect for self-serve car washes of all sizes. Thanks to a variety of size and option choices, Kleen-Rite coin boxes are suitable for use at new car wash builds or when upgrading older bays!**

Each coin box features industry components including Dixmor digital timers, IDX coin acceptors, and Mars bill acceptors. Kleen-Rite's boxes accept coins and tokens as well as \$1, \$5, \$10 and \$20 bills. The boxes are operated by a virtually maintenance-free rotary switch, allowing for up to 10 functions per bay!

## COIN BOX STYLE .....

### SHORT HULL



Kleen-Rite short hull coin boxes have a compact footprint and are designed for use with a separate safe. While paper money is held in the unit's bill acceptor, all coins drop through a tube into your hidden safe for extra security.

**SEE PAGE 400 FOR SAFE OPTIONS OR PAGE 468 FOR VAC IT UP SYSTEMS!**

### LONG HULL



Long hull boxes have a separate money drawer underneath the control unit. Coins drop down a chute into this vault, where they remain until emptied. Paper money continues to be collected and held within the unit's bill acceptor.

## COIN BOX SECURITY .....

### DELUXE

All-purpose choice suitable for many car wash businesses, especially those that have an attendant or are in low-crime areas. Each box has a durable, 11 gauge 304 stainless steel body and built-in cam locks to deter theft.

### HIGH SECURITY

High security coin boxes feature thicker, 7 gauge stainless steel construction. Each box also includes high security plug locks and extra security latches! Kleen-Rite high security coin boxes are a great choice for unattended car washes or high crime areas. While no single product can completely guarantee against theft, a high security coin box is a great deterrent! The added safety features make it harder to access funds, discouraging opportunistic thieves.



## SECURITY CONSIDERATIONS

- Is an attendant present at your wash during all business hours?
- Is your business located in a high crime area?
- Do you offer 24 hour a day services?
- Are there security cameras at your wash?

Plus, all Kleen-Rite coin boxes have slots to accommodate extra security bars. These bars fit over vulnerable areas such as cam locks and money drawers, then padlock into place for added protection.

# BAY ACCESSORIES

## CUSTOM OPTIONS

Kleen-Rite coin boxes may be further upgraded and customized after purchase. Many operators enjoy adding credit card acceptance through the CryptoPay system. This plug-and-play technology integrates directly with Kleen-Rite coin boxes to provide credit card acceptance at an affordable cost. Standalone coin box parts, such as drawers, locks, and bill acceptors, are also available for a completely custom build. Give us a call at 1-800-233-3873 to customize your ideal coin box today!

## ADDITIONAL OPTIONS

- Extra function decal sets
- Addition of a push button
- Credit card acceptors
- Different type of coin acceptor

### DELUXE

### HIGH SECURITY

SHORT HULL DESIGN FOR USE WITH SEPARATE SAFE OR VAC-IT-UP SYSTEM.



### DELUXE COIN BOXES

KLEEN-RITE COIN BOXES



• Our deluxe coin boxes make a great upgrade to older car washes. They are also a perfect fit for any new self-serve construction. The boxes come standard with a 10 position rotary selection switch and a Dixmor digital timer with last coin alert feature. The Mars Bill acceptor allows for the acceptance of bills ranging from \$1 to \$20. The MA850 Coin acceptor will take any type of coin, from tokens, quarters and dollar coins.

#### FEATURES:

- Dixmor digital timer
- Last coin alert
- 10 position "QC" rotary switch
- IDX MA850 coin acceptor
- Mars bill acceptor
- 11 gauge 304 stainless steel plate

#### OTHER OPTIONS:

- Choice of coin acceptor
- Credit card acceptance
- Different bill acceptor
- Piezo or mechanical push button

|                   |                |                            |
|-------------------|----------------|----------------------------|
| <b>\$2,575.00</b> | <b>CBK5000</b> | Long hull WITH COIN DRAWER |
| <b>\$2,270.00</b> | <b>CBK6000</b> | Short hull VAULT READY     |

### HIGH SECURITY COIN BOXES

KLEEN-RITE COIN BOXES



• For even more security at your car wash, upgrade to our High Security Meter Boxes. All the standard features of our traditional coin boxes plus added features.

#### FEATURES:

- Thicker 7 gauge stainless steel
- High security plug locks
- Dixmor digital timer
- Last coin alert
- 10 position "QC" rotary switch
- Reinforced timer display housing
- Added security latches
- IDX MA850 coin acceptor
- Mars bill acceptor

|                   |                  |            |
|-------------------|------------------|------------|
| <b>\$3,070.00</b> | <b>CBK5000HS</b> | Long Hull  |
| <b>\$2,605.00</b> | <b>CBK6000HS</b> | Short Hull |

ADD ON BOXES FOR MARS AND COINCO VALIDATORS CAN BE USED WITH DELUXE OR HIGH SECURITY COIN BOXES



### ADD ON BOX FOR COINCO VANTAGE VALIDATOR

KLEEN-RITE COIN BOXES

**CBKCBA**

### ADD ON BOX FOR MARS VALIDATOR

KLEEN-RITE COIN BOXES

**CBKCBA-M**



# BAY ACCESSORIES

## KLEEN-RITE BOOMS

### 360° CEILING MOUNT BOOMS

KLEEN-RITE

**KLEEN-RITE** CORP.

- 76" in length with stainless steel construction
- Side tap or top tap
- Never grease/No squeak bearings
- Includes boom swivel & boom hose



**FLAT PLATE**

**NEVER NEEDS GREASE**

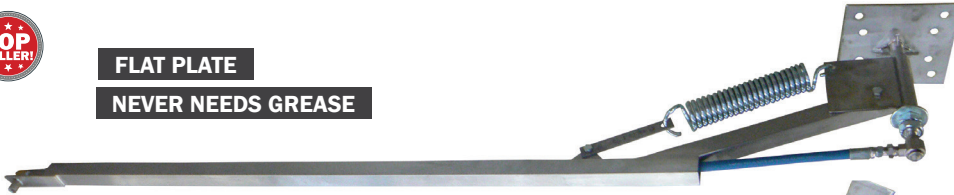

**X-BRACE**

**NEVER NEEDS GREASE**

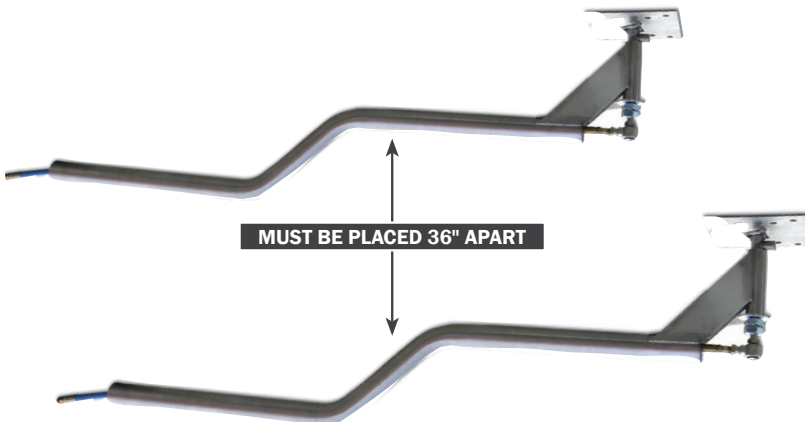
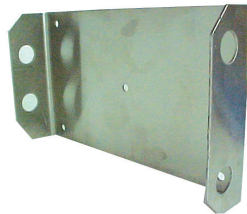

**MUST BE PLACED 36" APART**



### 360° DOUBLE BOOM

KLEEN-RITE

**KLEEN-RITE** CORP.

- Includes 2 booms - booms must be placed 36" apart on center to swing freely
- 2 flat plates

**\$1,091.51** BOKF61A

### FLAT PLATE - UNIVERSAL BOLT PATTERN

KLEEN-RITE 360° CEILING MOUNT BOOMS

**\$527.29** BOKF76A

### X-BRACE - STANDARD BOLT PATTERN

KLEEN-RITE 360° CEILING MOUNT BOOMS

**\$526.82** BOKX76A

### PARTS

KLEEN-RITE 360° CEILING MOUNT BOOMS

|                 |               |                                    |
|-----------------|---------------|------------------------------------|
| <b>\$191.69</b> | <b>BOKF</b>   | Flat Plate Base Only               |
| <b>\$18.68</b>  | <b>BOKB</b>   | Bushing                            |
| <b>\$32.05</b>  | <b>BOKSP</b>  | Spring Only                        |
| <b>\$72.41</b>  | <b>BOKB88</b> | 180° Wall Mount Conversion Bracket |

### STAINLESS STEEL WALL MOUNT FOAMY BOOM

KLEEN-RITE

- Great for foamy hoses
- 1/2 FPT discharge coupling
- Stainless steel
- 6' long
- 304 heavy duty
- Bracket included

|                 |                 |             |
|-----------------|-----------------|-------------|
| <b>\$326.54</b> | <b>B00150DB</b> | Double Boom |
| <b>\$165.85</b> | <b>B00150A</b>  | Single Boom |

### BOOM BUMPERS

KLEEN-RITE STAINLESS STEEL WALL MOUNT FOAMY BOOM

**\$21.96** BORB

### DOUBLE BOOM BRACKET

KLEEN-RITE STAINLESS STEEL WALL MOUNT FOAMY BOOM

**\$73.74** B00155D

### BOLT-DOWN VIBRATION-DAMPING MOUNT FOR COLEMAN BOOMS

- 1" height x 1.2" diameter x 3.13" base length x 1.75" base width
- For use with Coleman car wash boom arms
- Black neoprene rubber
- Mounting fasteners not included

**\$7.46** 51618-50

### TAPERED RUBBER STOP FOR COLEMAN BOOMS

KLEEN-RITE

**KLEEN-RITE** CORP.

- 1.5" x 1.5"
- For use with Coleman Hanna car wash boom arms
- Durable rubber construction

**\$8.04** RS1001-T

# BAY ACCESSORIES

## BOOMS

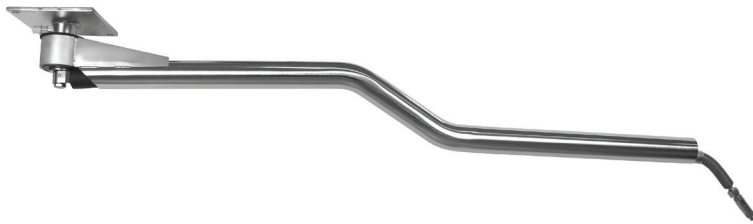

### 5'1" STAINLESS STEEL Z-BOOM HYDRO-SPRAY



- These 360° car wash booms feature a tough design with stainless steel construction. These Z-Booms are ready to use with self-lubricating ball bearings, high quality swivels and a insulated high pressure hose.
- 4000 PSI • 250° F maximum temperature
- 3/8" NPTF inlets • 3/8" NPTF Outlet

**\$679.84**    **B00240**



### STAINLESS STEEL ADJUSTABLE 360° CEILING BOOM SUTTNER



- The unique design allows you to shorten or extend boom to fit the size of car wash bays and lengthen for longer reach
- 2-ball bearings axle - permanently lubricated
- Stainless steel boom • High pressure hose with spring
- 3000 PSI • 250° F maximum temperature
- Adjusts from 42" - 72" • 3/8" MNPT outlet

**CALL**    **B00255**

### MAXI-FLEX CEILING & WALL BOOM MIGHTY CLEAN BOOMS

- Constructed of space age stainless steel alloy making it virtually indestructible with the ultimate in flexibility
- Stainless steel boom rod that can be pulled down 45° and will "flex" back without damage
- Comes standard with repairable quality ball bearing swivel and high quality trunnion bearing in base
- Two-piece construction for easy installation
- Mounting base designed to retrofit common hole patterns
- Heavy manifold attachments make hose unable to be pulled off
- Inlet ports accessible from either top or side of boom base
- Available in 5½ ft. • Ports are 3/8" FPT • Maximum 160° F

**\$270.55**    **B00170**    180° Wall Mount  
**\$270.73**    **B00175**    Round Base Maxi-Flex

### DUAL CEILING BOOM MOSMATIC BOOMS



- Ready for installation, integrated "SMART-Tech™" swivels, axle with "Perma-lube" ball bearings, insulated high pressure hose. Ideal for prep area.

|                 |                               |                 |                               |
|-----------------|-------------------------------|-----------------|-------------------------------|
| <b>BOM67409</b> | 4'9" x 5'3" Dual Ceiling Boom | <b>BOM67439</b> | 6'3" - 6'9" Dual Ceiling Boom |
| <b>BOM67419</b> | 5'3" x 5'9" Dual Ceiling Boom | <b>BOM67449</b> | 6'9" - 7'5" Dual Ceiling Boom |
| <b>BOM67429</b> | 5'9" x 6'3" Dual Ceiling Boom | <b>BOM67459</b> | 7'5" - 8'2" Dual Ceiling Boom |

**CALL FOR PRICES**

**CALL FOR PRICES**

### P-SERIES CAR WASH BOOMS MOSMATIC BOOMS



- Ideal for use in self-service carwash systems
- Made of high quality stainless steel tubing which guarantees strength and stability
- Max Pressure - 4000 PSI

| 180° WALL       | 360° CEILING    | DESCRIPTION                    |
|-----------------|-----------------|--------------------------------|
| <b>BOM68509</b> | <b>BOM66009</b> | 4'9" Stainless Steel Polished  |
| <b>BOM68519</b> | <b>BOM66019</b> | 5'3" Stainless Steel Polished  |
| <b>BOM68529</b> | <b>BOM66029</b> | 5'9" Stainless Steel Polished  |
| <b>BOM68539</b> | <b>BOM66039</b> | 6'3" Stainless Steel Polished  |
| <b>BOM68549</b> | <b>BOM66049</b> | 6'9" Stainless Steel Polished  |
| <b>BOM68559</b> | <b>BOM66059</b> | 7'5" Stainless Steel Polished  |
| <b>BOM68569</b> | <b>BOM66069</b> | 8'2" Stainless Steel Polished  |
| <b>BOM68579</b> | <b>BOM66079</b> | 9' Stainless Steel Polished    |
| <b>BOM68589</b> | <b>BOM66089</b> | 9'10" Stainless Steel Polished |

**CALL FOR PRICES**

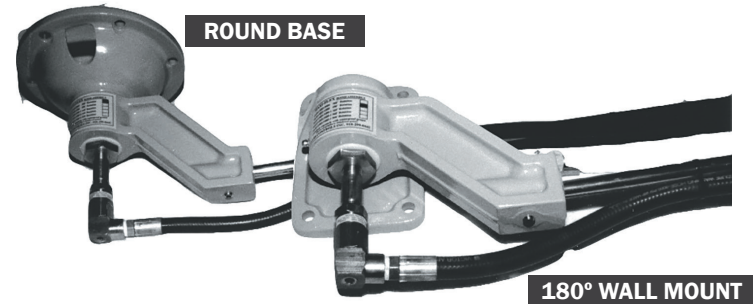

**ROUND BASE**

**180° WALL MOUNT**



**WALL MOUNT**



**CEILING MOUNT**

# BAY ACCESSORIES

## BOOMS

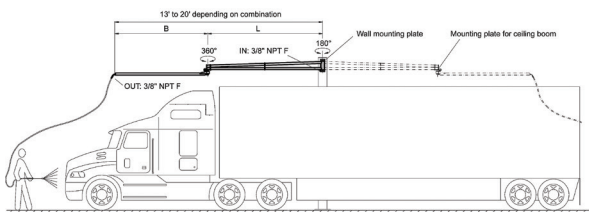

### WALL BOOM EXTENSION

USE WITH MOSMATIC P SERIES CEILING BOOM



- Ideal for use in truck & trailer wash bays
- Made of high-quality stainless steel tubing which guarantees strength and stability

|                        |                               |
|------------------------|-------------------------------|
| <b>BOM60522</b>        | 6'8" Stainless Steel Polished |
| <b>BOM60532</b>        | 8'2" Stainless Steel Polished |
| <b>CALL FOR PRICES</b> |                               |

|                        |                                |
|------------------------|--------------------------------|
| <b>BOM60542</b>        | 9'10" Stainless Steel Polished |
| <b>BOM60983</b>        | 14'9" Stainless Steel Polished |
| <b>CALL FOR PRICES</b> |                                |

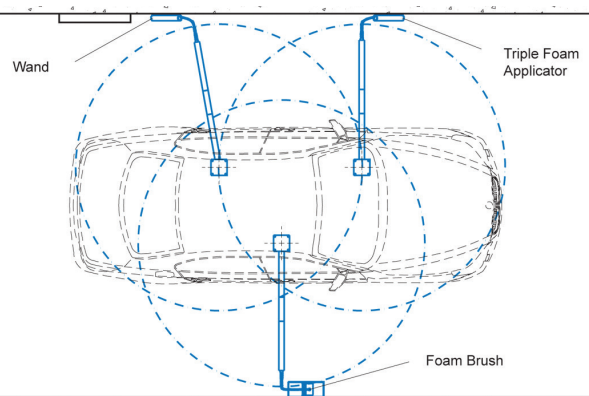
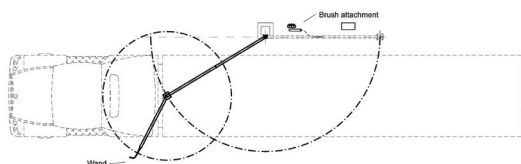

### DKZ 3 SERIES CEILING BOOM

MOSMATIC BOOMS



- This self-service car wash solution includes a patented Z-Series ceiling boom that allows continuous 360° rotation for the high pressure wand or foam brush. The installation of an optional positioning device guarantees a designated parking position for the ceiling boom.

|                        |                               |
|------------------------|-------------------------------|
| <b>BOM65009</b>        | 4'9" Stainless Steel Polished |
| <b>BOM65019</b>        | 5'1" Stainless Steel Polished |
| <b>CALL FOR PRICES</b> |                               |

|                        |                               |
|------------------------|-------------------------------|
| <b>BOM65029</b>        | 5'5" Stainless Steel Polished |
| <b>BOM65039</b>        | 5'9" Stainless Steel Polished |
| <b>CALL FOR PRICES</b> |                               |

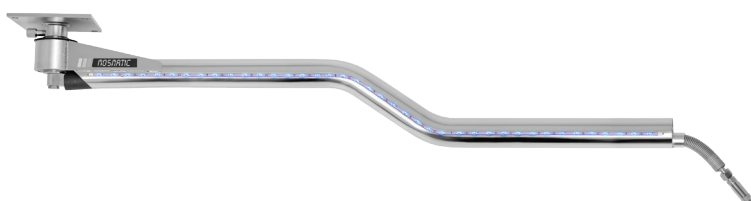

### LED CEILING BOOM

MOSMATIC BOOMS



- The LED Boom can be synchronized with your wash cycle to visualize your wash program. The LED ceiling boom is not only an eye-catcher for self-service car washes, but also provides additional lighting for the bay adding safety for your clients.

### CEILING MOUNT Z BOOM

|                 |      |
|-----------------|------|
| <b>BOM65209</b> | 4'9" |
| <b>BOM65219</b> | 5'1" |
| <b>BOM65229</b> | 5'5" |
| <b>BOM65239</b> | 5'9" |

### CEILING MOUNT BOOM

|                 |      |                        |       |
|-----------------|------|------------------------|-------|
| <b>BOM66209</b> | 4'9" | <b>BOM66259</b>        | 7'5"  |
| <b>BOM66219</b> | 5'3" | <b>BOM66269</b>        | 8'2"  |
| <b>BOM66229</b> | 5'9" | <b>BOM66279</b>        | 9'    |
| <b>BOM66239</b> | 6'3" | <b>BOM66289</b>        | 9'10" |
| <b>BOM66249</b> | 6'9" | <b>CALL FOR PRICES</b> |       |

### DUAL CEILING MOUNT BOOM

|                 |           |
|-----------------|-----------|
| <b>BOM67609</b> | 4'9"/5'3" |
| <b>BOM67619</b> | 5'3"/5'9" |
| <b>BOM67629</b> | 5'9"/6'3" |
| <b>BOM67639</b> | 6'3"/6'9" |
| <b>BOM67649</b> | 6'9"/7'5" |
| <b>BOM67659</b> | 7'5"/8'2" |

### CONTROL BOX FOR LED BOOMS

Includes: controller, power supply, remote control, receiver with housing.  
For 2 booms max.

**BOMP65975**

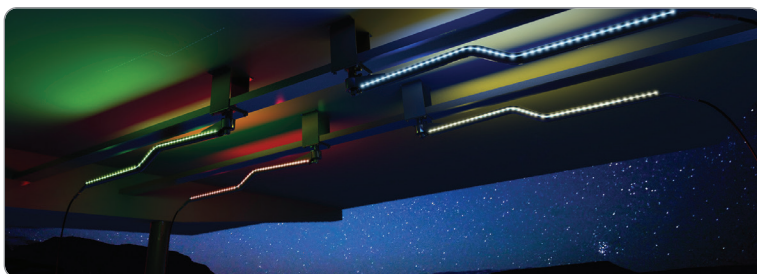

### MAGNETIC POSITION DEVICE

MOSMATIC BOOMS

- Available for all Mosmatic single pipe series ceiling booms. Specially designed to "park" the boom in the position you assigned. Easily installed and can be added to previously installed booms. An optional positioning device guarantees a designated parking position for the ceiling boom.

**CALL BOMP65911**

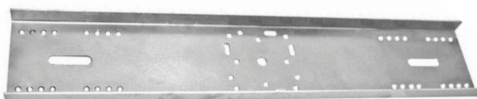

### OPTIONAL MOUNTING BRACKET

MOSMATIC BOOMS

- Install two Mosmatic DKZ ceiling booms on one center beam.
- Made from stainless steel. 47" in length.

**CALL BOMP65903**



### DROP DOWN STEMS

MOSMATIC BOOMS

- Drop down stems lower booms up to a total of 20" from the ceiling. Single boom use only

|                   |              |
|-------------------|--------------|
| <b>BOMP902753</b> | 2" Extension |
| <b>BOMP902752</b> | 4" Extension |
| <b>BOMP901875</b> | 8" Extension |

**CALL FOR PRICES**

# BAY ACCESSORIES

## BOOMS



Zierden Company  
machining, assembly, rebuilding

### COMPLETE BOOM ASSEMBLY

ZIERDEN COMPANY

- The Zierden Boom is ideal for heavy commercial use in coin-operated car washes, service bays, and in car and truck fleet cleaning departments. The boom permits 360° of free and easy rotation around a vehicle in an 11 foot diameter. Heavy gauge steel mounting base, non-corrosive metal internal parts and double ram ball bearings for effortless boom swing. Boom is 5 feet. Extensions are also available.

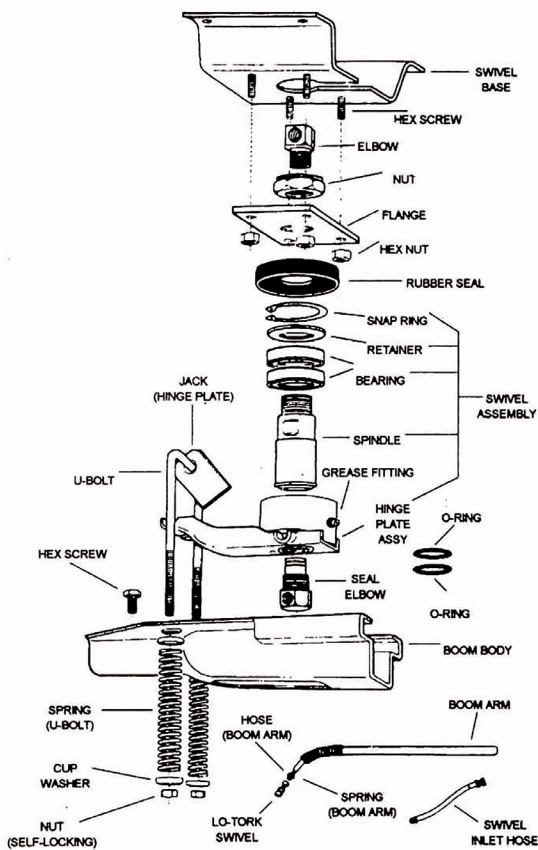

|          |        |   |
|----------|--------|---|
| \$2.50   | B00064 | Back Up Ring  |
| \$26.11  | B00065 | Elbow Seal  |
| \$1.93   | B00066 | O Ring/Elbow Seal                                     |
| \$1.77   | B00067 | Retainer  |
| \$1.55   | B00068 | Snap Ring   |
| \$52.83  | B00072 | Boom Bodies   |
| \$25.89  | B00074 | 5' Pipe   |
| \$7.05   | B00075 | Spring (for pipe)                                     |
| \$2.25   | B00076 | Locknut 1" (Thin)                                     |
| \$10.54  | B00077 | Mounting Flange (small)                               |
| \$23.85  | B00078 | Swivel Base Assembly Rectangular <b>**NEW STYLE**</b> |
| \$17.65  | B00079 | Cartridge Collar/Flange                               |
| \$9.85   | B00081 | U Bolt  |
| \$5.89   | B00082 | U Bolt Spring   |
| \$0.82   | B00083 | Cup Washers   |
| \$0.75   | B00084 | Nuts  |
| \$1.90   | B00085 | Jacks   |
| \$26.48  | B00086 | Hinge Plate/ Old style                                |
| \$101.26 | B00089 | Swivel & Hinge Plate Assembly                         |
| \$23.60  | B00091 | Boom Arm With Spring                                  |
| \$1.93   | B00092 | O Ring (Yellow Mark)                                  |
| \$7.99   | B00093 | Single Row Bearing                                    |
| \$32.85  | B00095 | Spindle   |

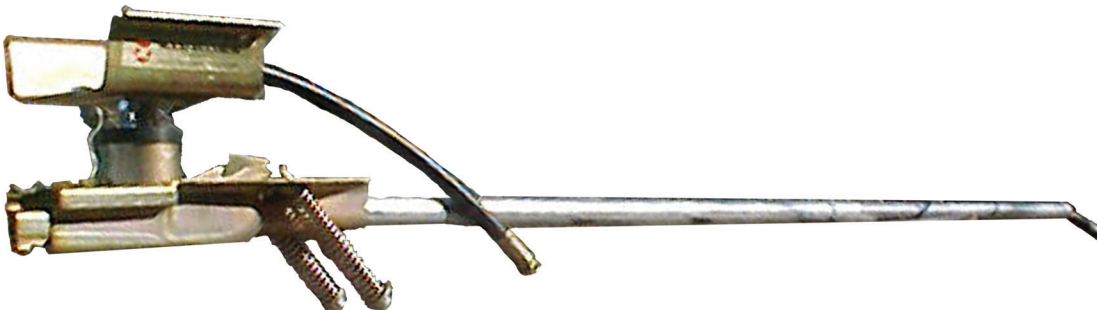

### COMPLETE BOOM ASSEMBLY

ZIERDEN COMPANY

**\$263.03** B00050A

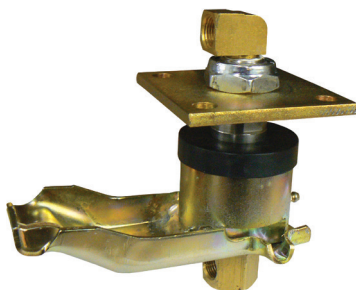

### CONVERSION KIT

ZIERDEN COMPANY

- For converting Model 203 sealed cartridge boom to the NEW Model 204 easy boom service

**\$125.45** B00070



### 360° OVERHEAD SWIVEL CARTRIDGE

ZIERDEN COMPANY

#### NON-REBUILDABLE

|         |        |           |
|---------|--------|-----------|
| \$87.03 | SW2500 | 1/4" Side |
| \$87.03 | SW2700 | 3/8" Side |
| \$87.03 | SW2900 | 3/8" TT   |

#### FACTORY REBUILDABLE

|         |          |      |
|---------|----------|------|
| \$87.03 | SW2300SS | 3/8" |
|---------|----------|------|