

AUTOMATICS & TUNNELS

ROLLERS AND CHAINS

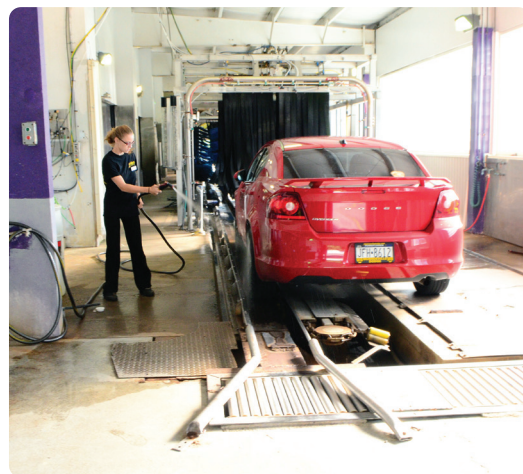
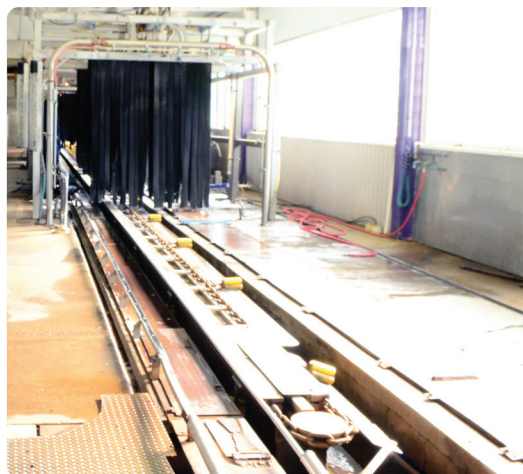

| CONVEYOR LENGTH IN FEET | X458 10' SECTION | ROLLER SPACING ON CONVEYOR | | | |
|-------------------------|------------------|----------------------------|---------------|------------------------------|---------------|
| | | 7'-4" ROLLER SPACING | | 3'-6" & 3'-4" ROLLER SPACING | |
| | | ROLLERS | CHAIN SECTION | ROLLERS | CHAIN SECTION |
| 40 | 8 | 11 | 10 | 22 | 21 |
| 45 | 9 | 12 | 11 | 24 | 23 |
| 50 | 10 | 14 | 13 | 27 | 26 |
| 55 | 11 | 15 | 14 | 30 | 29 |
| 60 | 12 | 16 | 15 | 32 | 31 |
| 65 | 13 | 18 | 17 | 35 | 34 |
| 70 | 14 | 19 | 18 | 38 | 37 |
| 75 | 15 | 20 | 19 | 41 | 40 |
| 80 | 16 | 22 | 21 | 43 | 42 |
| 85 | 17 | 23 | 22 | 46 | 45 |
| 90 | 18 | 24 | 23 | 49 | 48 |
| 95 | 19 | 26 | 25 | 51 | 50 |
| 100 | 20 | 27 | 26 | 54 | 53 |
| 105 | 21 | 29 | 28 | 57 | 56 |
| 110 | 22 | 30 | 29 | 60 | 59 |
| 115 | 23 | 31 | 30 | 62 | 61 |
| 120 | 24 | 33 | 32 | 65 | 64 |
| 125 | 25 | 34 | 33 | 68 | 67 |
| 130 | 26 | 35 | 34 | 70 | 69 |
| 135 | 27 | 37 | 36 | 73 | 72 |
| 140 | 28 | 38 | 37 | 76 | 75 |
| 145 | 29 | 39 | 38 | 78 | 77 |
| 150 | 30 | 41 | 40 | 81 | 80 |
| 155 | 31 | 42 | 41 | 84 | 83 |
| 160 | 32 | 43 | 42 | 87 | 86 |
| 165 | 33 | 45 | 44 | 89 | 88 |
| 170 | 34 | 46 | 45 | 92 | 91 |
| 175 | 35 | 47 | 46 | 95 | 94 |
| 180 | 36 | 49 | 48 | 97 | 96 |
| 185 | 37 | 50 | 49 | 100 | 99 |

AUTOMATICS & TUNNELS

ROLLER REPLACEMENT PARTS

MACNEIL®

VT125
COMPLETE UNIT

VT2000 & MACNEIL® CONVEYOR ROLLER ASSEMBLY REPLACEMENT PARTS

| PRICE | PART | DESCRIPTION |
|-----------------|-----------------|---|
| \$101.82 | RYVT125 | Roller Assembly for VT2000 and MacNeil Conveyor |
| \$15.95 | RYVT125A | Replacement Roller, red, outrigger wheel for roller assembly #VT125, for VT2000 and will fit MacNeil conveyor |
| \$13.70 | RYVT125B | Replacement Wheel Pusher, yellow, for roller assembly #VT125, for VT2000 and will fit MacNeil conveyor |
| \$9.10 | RYVTB4 | Bushing Kit for RYVT125 Contains a set of 4/1.125"O.D. X .760 I.D. X 1.400 long |

California PROPOSITION 65

California PROPOSITION 65

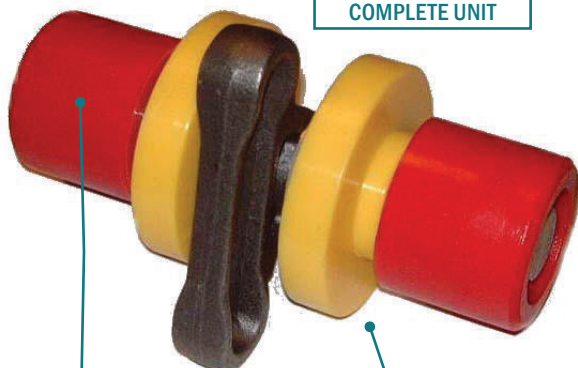

VT125A ONLY

VT125B ONLY



BUSHING KIT

ECONOCRAFT®

HANNA™ RCV STYLE



ECONOCRAFT® REPLACEMENT ROLLER REPLACEMENT PARTS

- Welded shaft

| | | |
|----------------|-----------------|------|
| \$73.25 | ECRCV214 | 2 ¼" |
| \$75.75 | ECRCV234 | 2 ¾" |



KLEEN-RITE REPLACEMENT ROLLER FOR HANNA™ STYLE RCV ROLLER KLEEN-RITE'S REPLACEMENT ROLLERS

- Bolted Shaft
- RCV Standard Roller with 1" W x 3½" D steel wheel
- CHAIN ATTACHMENT SOLD SEPARATELY

| PRICE | PART # | IDLER WHEEL |
|----------------|----------------|-------------|
| \$98.90 | RCVR214 | 2¼" Wide |
| \$95.05 | RCVR234 | 2¾" Wide |

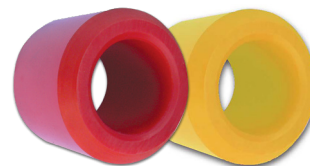

PUSHER WHEEL HANNA STYLE RCV ROLLER REPLACEMENT PARTS

- 2 required
- 3" x 3¼" tire plastic

| | | |
|---------------|---------------|--------|
| \$8.47 | RCVTP | Red |
| \$9.84 | RCVTPY | Yellow |



BUSHING HANNA STYLE RCV ROLLER REPLACEMENT PARTS

- 2 Required
- 5/8" inner diameter

| | |
|---------------|-------------|
| \$4.00 | RCVB |
|---------------|-------------|

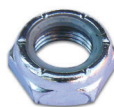

NYLON LOCK NUT REPLACEMENT PARTS

- (2) Required • 5/8"

| | |
|---------------|--------------|
| \$0.50 | 37138 |
|---------------|--------------|



½" x ¾" HEX BOLT REPLACEMENT PARTS

- 2 required

| | |
|---------------|--------------|
| \$0.31 | 13203 |
|---------------|--------------|



REAR AXLE CROSS REPLACEMENT PARTS

- 7/8"

| | |
|---------------|--------------|
| \$9.88 | RCVRA |
|---------------|--------------|



STEEL WASHER REPLACEMENT PARTS

| | | |
|---------------|----------------|-------------------|
| \$0.13 | 0133012 | 1/2" (2) required |
| \$0.18 | 33094 | 7/8" (2) required |

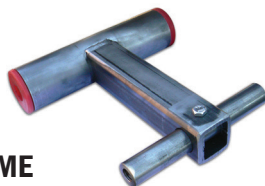

FRAME REPLACEMENT PARTS

- 1 Required
- BUSHINGS NOT INCLUDED

| | |
|-------------|-----------------|
| CALL | RCVFRAME |
|-------------|-----------------|



FRONT SHAFT REPLACEMENT PARTS

- 1 Required • 5/8" D x 9¾" L

| | |
|----------------|--------------|
| \$11.00 | RCVFS |
|----------------|--------------|

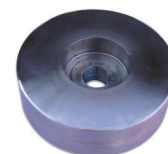

STEEL WHEEL REPLACEMENT PARTS

- 2 Required • 1" x 3½" Diameter

| | |
|----------------|--------------|
| \$21.30 | RCVSW |
|----------------|--------------|

CALIFORNIA PROPOSITION 65 NOTE: some items on this page may fall under the Proposition 65 act. Please consult the State of California Proposition 65 list (oehha.ca.gov/proposition-65/proposition-65-list) to learn more and to see a comprehensive list of Proposition 65 chemicals.

AUTOMATICS & TUNNELS

ROLLER REPLACEMENT PARTS

HANNA™ 6 WHEEL LOW PROFILE STYLE



6 WHEEL LOW PROFILE ROLLER

HANNA REPLACEMENT PARTS

• Chain attachment sold separately

| 2 1/4" WIDE IDLER WHEEL | | |
|-------------------------|-----------|--------|
| PRICE | PART # | COLOR |
| \$56.48 | 6WLPR214 | Red |
| \$44.50 | 6WLPR214Y | Yellow |
| 2 3/4" WIDE IDLER WHEEL | | |
| PRICE | PART # | COLOR |
| \$59.83 | 6WLPR234 | Red |
| \$46.75 | 6WLPR234Y | Yellow |



6 WHEEL LOW PROFILE ROLLER WITH M2 LINK

HANNA REPLACEMENT PARTS

• Chain attachment sold separately

| 2 1/4" WIDE IDLER WHEEL | | |
|-------------------------|--------------|--------|
| PRICE | PART # | COLOR |
| \$56.55 | 6WLPR214-M2 | Red |
| \$56.55 | 6WLPR214Y-M2 | Yellow |
| 2 3/4" WIDE IDLER WHEEL | | |
| PRICE | PART # | COLOR |
| \$71.53 | 6WLPR234-M2 | Red |
| \$57.65 | 6WLPR234Y-M2 | Yellow |



6 WHEEL LOW PROFILE ROLLER - BOLTED SHAFT

HANNA REPLACEMENT PARTS

• Chain attachment sold separately

| 2 1/4" WIDE IDLER WHEEL | | |
|-------------------------|-------------|--------|
| PRICE | PART # | COLOR |
| \$44.75 | 6WLPR214Y-B | Yellow |
| 2 3/4" WIDE IDLER WHEEL | | |
| PRICE | PART # | COLOR |
| \$46.99 | 6WLPR234Y-B | Yellow |



LOW PROFILE FRAME

HANNA REPLACEMENT PARTS

• (1) Required

| | |
|---------|--------|
| \$34.89 | 6WRLPF |
|---------|--------|



PUSHER WHEEL

HANNA REPLACEMENT PARTS

4 REQUIRED

• 2" D x 4" L x 1" inner diameter

| | | |
|--------|------|--------|
| \$5.49 | 6WP | Red |
| \$4.93 | 6WPY | Yellow |

HANNA™ 6 WHEEL HIGH PROFILE STYLE



STYLE 6 WHEEL HIGH PROFILE ROLLER

HANNA REPLACEMENT PARTS

• Chain attachment sold separately

| PRICE | PART # | IDLER WHEEL |
|---------|----------|-------------|
| \$51.77 | 6WHPR214 | 2 1/4" Wide |
| \$54.94 | 6WHPR234 | 2 3/4" Wide |

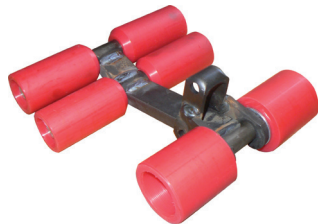

STYLE 6 WHEEL HIGH PROFILE ROLLER WITH M2 LINK

HANNA REPLACEMENT PARTS

• Chain attachment sold separately

| PRICE | PART # | IDLER WHEEL |
|---------|-------------|-------------|
| \$51.77 | 6WHPR214-M2 | 2 1/4" Wide |
| \$54.94 | 6WHPR234-M2 | 2 3/4" Wide |



HIGH PROFILE FRAME

HANNA REPLACEMENT PARTS

• (1) Required

| | |
|---------|--------|
| \$46.25 | 6WRHPF |
|---------|--------|



PUSHER WHEEL

HANNA REPLACEMENT PARTS

4 REQUIRED

• 2" D x 4" L x 1" inner diameter

| | | |
|--------|------|--------|
| \$5.49 | 6WP | Red |
| \$4.93 | 6WPY | Yellow |

FOR HANNA™, ECONOCRAFT®, SONNY'S®, & BELANGER® ROLLERS



IDLER WHEEL

ROLLER PARTS

2 REQUIRED

| 2 1/4" D x 2 1/4" L x 7/8" B | | |
|------------------------------|-----------|--------|
| PRICE | PART # | COLOR |
| \$4.73 | 21/4IW | Red |
| \$4.57 | 21/4IWY | Yellow |
| \$7.27 | 21/4IWB | Blue |
| 2 1/2" D x 2 3/4" L x 7/8" B | | |
| PRICE | PART # | COLOR |
| \$6.28 | 23/4IW | Red |
| \$6.05 | 23/4IWY | Yellow |
| \$6.26 | 23/4IWB | Blue |
| 2 1/4" D x 1 1/8" L | | |
| PRICE | PART # | COLOR |
| \$1.73 | 21/4118IW | Red |



1/2" x 3/4" HEX BOLT

PARTS

| | |
|--------|-------|
| \$0.31 | 13203 |
|--------|-------|



STEEL WASHERS

PARTS

| | | |
|--------|---------|------|
| \$0.10 | 0133012 | 1/2" |
| \$0.18 | 33094 | 7/8" |

AUTOMATICS & TUNNELS

ROLLER REPLACEMENT PARTS

BELANGER® 6 WHEEL ROLLERS

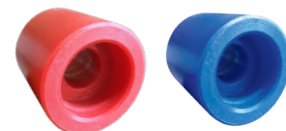

REPLACEMENT ROLLER BELANGER REPLACEMENT PARTS

- Welded shaft

| | | | |
|---------|----------|-----|------|
| \$54.55 | B6WL214 | 2¼" | Red |
| \$54.55 | B6WL214B | 2¼" | Blue |
| \$54.60 | B6WL234 | 2¾" | Red |
| \$54.60 | B6WL234B | 2¾" | Blue |
| \$57.89 | B6WL258 | 2⅝" | Red |
| \$57.89 | B6WL258B | 2⅝" | Blue |

PUSHER WHEEL 4 REQUIRED BELANGER REPLACEMENT PARTS

- 2¼" D x 3⅝" L x 1" Bore

| | | |
|--------|---------|------|
| \$9.94 | BTP318 | Red |
| \$9.92 | BTP318B | Blue |

PUSHER WHEEL 4 REQUIRED BELANGER REPLACEMENT PARTS

- 2¼" D x 3¾" L x 1" Bore

| | | |
|---------|---------|------|
| \$10.53 | BTP334 | Red |
| \$9.92 | BTP334B | Blue |

IDLER WHEEL 2 REQUIRED BELANGER REPLACEMENT PARTS

- 2¼" D x 2⅝" L x ⅞" Bore

| | | |
|--------|---------|------|
| \$6.95 | 25/8IW | Red |
| \$6.78 | 25/8IWB | Blue |

FOR SONNY'S® 4 WHEEL & 6 WHEEL ROLLERS

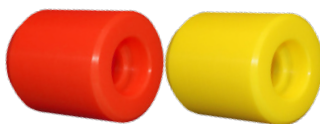

PUSHER WHEEL SONNY'S ROLLER PARTS

- 3" D x 3⅝" L x 1" B

| | | |
|--------|--------|--------|
| \$9.46 | MPTP3 | Red |
| \$9.92 | MPTP3Y | Yellow |

FOR SONNY'S® LOW, TALL, & MID PROFILE ROLLERS

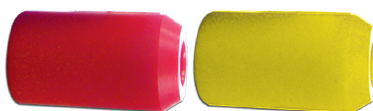

PUSHER WHEEL SONNY'S ROLLER PARTS

- 2¼" D x 4" L x 1" B

| | | |
|--------|----------|--------|
| \$8.73 | MPTP214 | Red |
| \$9.92 | MPTP214Y | Yellow |

FOR RYKO® ROLLERS



RYKO® REPLACEMENT ROLLER REPLACEMENT PARTS

- Welded shaft

| | |
|----------|---------|
| \$117.67 | RYK0100 |
|----------|---------|

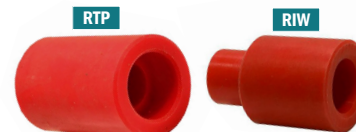

RYKO® REPLACEMENT PARTS REPLACEMENT PARTS

| | | |
|---------|-----|----------------------|
| \$47.12 | RTP | Pusher - No Shoulder |
| \$17.72 | RIW | Idler - Shoulder |

REPLACEMENT ROLLERS FOR OTHER MODELS

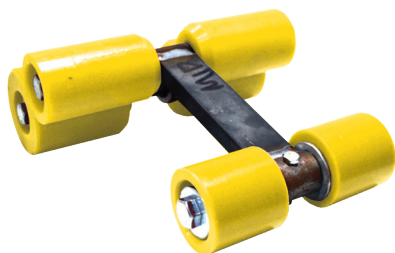

MID-PROFILE REPLACEMENT ROLLER REPLACEMENT PARTS

- Bolted Shaft

| PRICE | PART # | IDLER WHEEL | COLOR |
|---------|---------|-------------|--------|
| \$55.99 | MPR214 | 2¼" | Red |
| \$55.99 | MPR214Y | 2¼" | Yellow |

| PRICE | PART # | IDLER WHEEL | COLOR |
|---------|---------|-------------|--------|
| \$57.05 | MPR234 | 2¾" | Red |
| \$57.05 | MPR234Y | 2¾" | Yellow |

New!



REPLACEMENT LOG LINK ROLLER SONNY'S ROLLER PARTS

- Same materials and measurements as original rollers

| | | |
|---------|---------|-------|
| \$88.24 | CON125S | white |
|---------|---------|-------|

AUTOMATICS & TUNNELS

CHAINS & PARTS

D88K



D88KPC PIN & COTTER

D88K PARTS

• Pitch 2.609"

| | | |
|-----------------|------------------|---------------------------------------|
| \$35.33 | D88KPC-16 | Pin & Cotter Chain (16 Pitch Section) |
| \$149.99 | D88KPC-34 | Pin & Cotter Chain (34 Pitch Section) |



D88K RIVETED

D88K PARTS

• Pitch 2.609"

| | | |
|----------------|----------------|----------------------------------|
| \$40.99 | D88K-16 | Riveted Chain (16 Pitch Section) |
| \$86.90 | D88K-34 | Riveted Chain (34 Pitch Section) |



D88KPC LINKS

D88K PARTS

| PRICE | PART # | SIDE |
|---------------|----------------|-----------|
| \$9.93 | D88KALL | Driver |
| \$9.93 | D88KARL | Passenger |

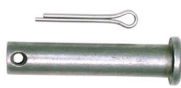

2 3/16" PIN & COTTER

D88K PARTS

| | |
|---------------|---------------|
| \$2.65 | D88KDP |
|---------------|---------------|



2 7/16" PIN & COTTER

D88K PARTS

| | |
|---------------|----------------|
| \$3.65 | D88KDPL |
|---------------|----------------|



STAINLESS STEEL COTTER ONLY

D88K PARTS

| | |
|---------------|----------------|
| \$0.30 | D88KS-S |
|---------------|----------------|



M2 LINK

D88K PARTS

| | |
|----------------|---------------|
| \$11.01 | D88KM2 |
|----------------|---------------|

D81X



D81X RIVETED CHAIN

D81X PARTS

• Pitch 2.609"

| | |
|------------------------|-------------|
| \$81.10 PER FT. | D81X |
|------------------------|-------------|

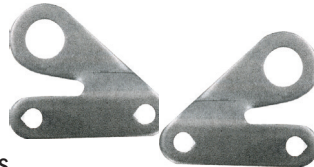

LINKS

D81X PARTS

| PRICE | PART # | SIDE |
|---------------|---------------|-----------|
| \$2.99 | D81XLL | Driver |
| \$2.99 | D81XRL | Passenger |



2 3/16" PIN & COTTER

D81X PARTS

| | |
|---------------|---------------|
| \$2.65 | D88KDP |
|---------------|---------------|

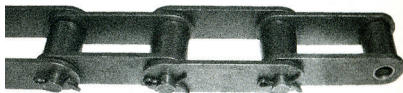

D81X PIN & COTTER

D81X PARTS

| | | |
|------------------------|------------------|----------|
| \$87.55 PER FT. | D81XPC-16 | 16 Pitch |
| CALL FOR PRICE | D81XPC-34 | 34 Pitch |



M2 LINK

D81X PARTS

| | |
|----------------|---------------|
| \$13.05 | D81XM2 |
|----------------|---------------|



CARRIER LINK

D81X PARTS

| | |
|---------------|----------------|
| \$4.35 | D81XH-T |
|---------------|----------------|



PIN & COTTER FOR D81HX

D81X PARTS

| | |
|---------------|---------------|
| \$2.25 | D81XHP |
|---------------|---------------|

X458 & X348



CHAIN SECTIONS

X458 & X348 PARTS

• Sold in 10 ft. sections - Price is per 10 feet

| | |
|----------------------------|-------------|
| \$80.50 PER 10 FT. | X348 |
| \$102.10 PER 10 FT. | X458 |



CARRIER LINK

X348 & X458 PARTS

| | |
|----------------|---------------|
| \$13.13 | X458CL |
|----------------|---------------|



CARRIER LINK

X348 & X458 PARTS

| | |
|----------------|---------------|
| \$22.06 | CLX458 |
|----------------|---------------|



CARRIER LINK

X348 & X458 PARTS

| | |
|----------------|------------------|
| \$22.06 | CLX458-M2 |
|----------------|------------------|



BAR

X348 & X458 PARTS

| | |
|---------------|----------------|
| \$4.75 | X458BAR |
|---------------|----------------|



PIN

X348 & X458 PARTS

| | |
|---------------|----------------|
| \$2.40 | X458PIN |
|---------------|----------------|



CARRIER LINK

X348 & X458 PARTS

| | |
|----------------|---------------|
| \$25.61 | CLX348 |
|----------------|---------------|

AUTOMATICS & TUNNELS

CHAINS & PARTS

C188

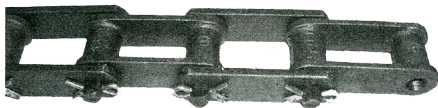

C188 (PITCH 2.609")

C188 CHAINS & PARTS

- Sold in 10 ft. sections
- Pin & Cotter Chain
- Same Side Steel Cotters

\$96.05 PER 10 FT C188-10



BLOCK LINK

C188 CHAINS & PARTS

\$3.95 C188BLOCK

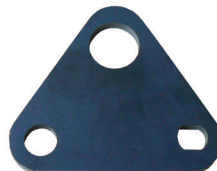

7/8" RIGHT OR LEFT LINK

C188 CHAINS & PARTS

\$4.58 TRIPL



C188 PIN & COTTER

C188 CHAINS & PARTS

\$1.95 188P

SC78

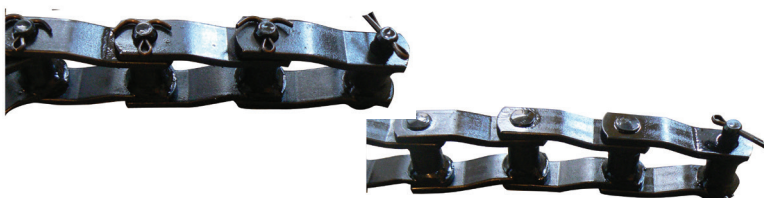

SC78 & SC78PC (PITCH 2.609")

MISCELLANEOUS PARTS

- Riveted pin & cotter

| | | |
|----------------|------------------|---------------------------------------|
| \$37.69 | SC78-16 | Riveted Chain (16 Pitch Section) |
| \$39.15 | SC78PC-16 | Pin & Cotter Chain (16 Pitch Section) |



M2 LINKS

SC78 CHAINS & PARTS

\$11.05 SC78M2



PIN & COTTER

SC78 CHAINS & PARTS

\$2.75 SC78P

CHAINS, BUSHINGS & SPROCKETS



LOG CHAIN (3 1/2" PITCH)

MISCELLANEOUS PARTS

- Heat treated

\$8.75 LOGCH



TAPERED LOCK BUSHINGS

MISCELLANEOUS PARTS

\$41.64 TLB2517-214 2 1/4"



12T SHAFT TAKE UP SPROCKET

MISCELLANEOUS PARTS

| | | |
|----------------|-----------------------|----------|
| \$89.99 | SPROCK-TU12 | 11" |
| \$89.99 | SPROCK-TU12SON | 10 3/16" |



12 TOOTH SPROCKET

MISCELLANEOUS PARTS

- For D81X, D88K, C188, SC78 Chains

\$122.99
SPROCKET12



4 TOOTH SPROCKET

MISCELLANEOUS PARTS

- For X458

\$139.00
SPROCKET458

SPIDERS & COUPLINGS



HYTREL PLASTIC



BUNA RUBBER



URETHANE PLASTIC

LOVEJOY SPIDERS

MISCELLANEOUS PARTS

| PRICE | PART # | DESCRIPTION | MATERIAL | COLOR |
|----------------|----------------|------------------------|------------------|-------|
| \$26.73 | FCS075H | L075/AL075 | Hytrex Plastic | Tan |
| \$35.66 | FCS090H | L090/AL090, L095/AL095 | Hytrex Plastic | Tan |
| \$84.89 | FCS099H | L099/AL099, L100/AL100 | Hytrex Plastic | Tan |
| \$9.10 | FCS075B | L075/AL075 | Buna Rubber | Black |
| \$11.79 | FCS090B | L090/AL090, L095/AL095 | Buna Rubber | Black |
| \$24.82 | FCS099B | L099/AL099, L100/AL100 | Buna Rubber | Black |
| \$49.22 | FCS099U | L099/AL099, L100/AL100 | Urethane Plastic | Blue |
| \$96.43 | FCS110U | L110/AL110 | Urethane Plastic | Blue |



SPLIT



NOT SPLIT

FLEX COUPLINGS

MISCELLANEOUS PARTS

| PRICE | PART # | DESCRIPTION |
|----------------|---------------|----------------------------|
| \$15.33 | FC4JES | Flex Coupling, Split, EPDM |
| \$26.84 | FC5JES | Flex Coupling, Split, EPDM |
| \$41.83 | FC6JES | Flex Coupling, Split, EPDM |
| \$53.67 | FC7JES | Flex Coupling, Split, EPDM |
| \$49.84 | FC7JE | Flex Coupling, EPDM |
| \$72.83 | FC8JES | Flex Coupling, Split, EPDM |

AUTOMATICS & TUNNELS

BEARINGS, FLANGES AND COUPLERS



ER BEARING INSERTS

AUTOMATICS HARDWARE

| PRICE | KR PART # | MFG. PART # | SIZE | DESCRIPTION |
|---------|------------|-------------|------|------------------------|
| \$19.75 | SER16 | ER205-16 | 1" | Bearing |
| \$35.37 | SER24 | ER208-24 | 1½" | Bearing |
| \$24.23 | HSBS21005F | ER206-19 | 1¾" | Bearing W/ Lock Collar |



BEARING INSERTS

AUTOMATICS HARDWARE

| PRICE | KR PART # | MFG. PART # | SIZE |
|---------|-----------|-------------|------|
| \$24.57 | UC20720 | UC206-20 | 1¼" |
| \$22.73 | UC20620 | UC207-20 | 1¼" |

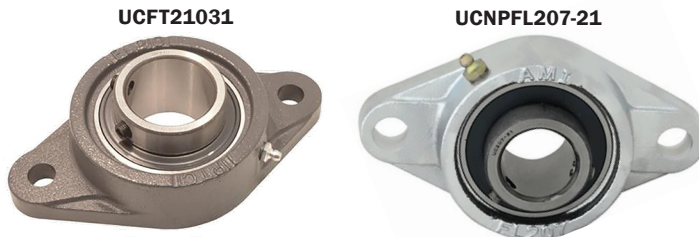

2 BOLT FLANGE BEARING WITH SET SCREW LOCK

AUTOMATICS HARDWARE

| PRICE | KR PART # | MFG. PART # | SIZE |
|----------|----------------------------|--------------|----------------------------------|
| \$27.55 | UCFT20516 | UCFL205-16 | 1" |
| \$37.99 | RY240 | UCFL207-20 | 1¼" |
| \$49.14 | RY245 | UCFL208-24 | 1½" |
| \$66.66 | UCFT21031 | UCFL210-31 | 1 ⁵ / ₁₆ " |
| \$107.94 | UCNPFL207-21 Nickel Plated | UCNPFL207-21 | 1 ⁵ / ₁₆ " |

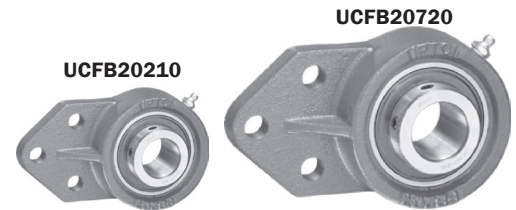

3 BOLT FLANGE BEARINGS WITH SET SCREW LOCK

AUTOMATICS HARDWARE

- Reliable and durable bearing for your conveyor units. The perfect accessory for your automatic car wash bays.
- Cast iron housing with a wide inner race bearing and B-type seal.

| PRICE | KR PART # | MFG. PART # | SIZE |
|---------|-----------|-------------|------|
| \$31.28 | UCFB20210 | UCFB202-10 | 5/8" |
| \$46.57 | UCFB20720 | UCFB207-20 | 1¼" |

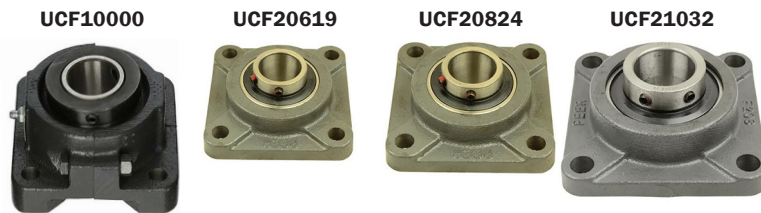

4 BOLT FLANGE BEARINGS WITH SET SCREW LOCK

AUTOMATICS HARDWARE

| PRICE | KR PART # | MFG. PART # | SIZE |
|---------|-----------|-------------|----------------------------------|
| \$33.90 | UCF20619 | UCF206-19 | 1 ³ / ₁₆ " |
| \$49.15 | UCF20824 | UCF208-24 | 1½" |
| \$49.14 | UCF20825 | UCF208-25 | 1 ⁹ / ₁₆ " |
| \$66.66 | UCF21031 | UCF210-31 | 1 ⁵ / ₁₆ " |
| \$66.66 | UCF21032 | UCF210-32 | 2" |
| \$81.93 | UCF21132 | UCF211-32 | 2" |



HANGER BEARINGS WITH SET SCREW LOCK

AUTOMATICS HARDWARE

- Industrial cast iron for high durability and a long-lasting service life.
- Standard duty, anti-rotation pin with an B-type seal.

| PRICE | KR PART # | MFG. PART # | SIZE |
|---------|-----------|-------------|------|
| \$30.54 | UCHA20516 | UCHA205-16 | 1" |
| \$46.57 | UCHA20720 | UCHA207-20 | 1¼" |

AUTOMATICS & TUNNELS

BEARINGS, FLANGES AND COUPLERS

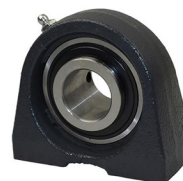

2 BOLT PILLOW BLOCK WITH SET SCREW LOCK

AUTOMATICS HARDWARE

| PRICE | KR PART # | MFG. PART # | SIZE |
|---------|-----------|-------------|---------|
| \$29.03 | UCP20516 | UCP205-16 | 1" |
| \$36.13 | UCP20619 | UCP206-19 | 1 3/16" |
| \$55.62 | RY241 | UCP207-20 | 1 1/4" |
| \$50.65 | UCP20824 | UCP208-24 | 1 1/2" |
| \$70.74 | UCP21032 | UCP210-32 | 2" |

TAPERED BASE PILLOW BLOCK BEARINGS WITH SET SCREW LOCK

AUTOMATICS HARDWARE

| PRICE | PART # | MFG. PART # | SIZE |
|---------|----------------------------|-------------|--------|
| \$38.73 | UCPA20620 3" on center | UCPA206-20 | 1 1/4" |
| \$46.57 | UCPA20720 3 3/4" on center | UCPA207-20 | 1 1/4" |



ROD ENDS - THREADED RIGHT HAND WITH ZERK (GREASE FITTING) - 3 PIECE - COMMERCIAL - SINTERED BRONZE

AUTOMATICS HARDWARE

| PRICE | KR PART # | MFG. PART # | SIZE |
|---------|-----------|-------------|------------------------|
| \$9.03 | VF5G | F5SBZ | Rod End - 5/16" Female |
| \$13.81 | VF8G | F8SBZ | Rod End - 1/2" Female |
| \$18.87 | VF10G | F10SBZ | Rod End - 5/8" Female |
| \$23.93 | VF12G | F12SBZ | Rod End - 3/4" Female |

ROD ENDS - FEMALE THREADED RIGHT HAND WITH ZERK (GREASE FITTING) - 2 PIECE - METAL-TO-METAL

AUTOMATICS HARDWARE

| PRICE | PART # | SIZE |
|---------|--------|------------------------|
| \$6.63 | VM5G | Rod End - 5/16" Female |
| \$10.57 | VM7G | Rod End - 1/2" Female |



ROD ENDS - MALE THREADED LEFT HAND WITH ZERK (GREASE FITTING) - 3 PIECE - COMMERCIAL - SINTERED BRONZE

AUTOMATICS HARDWARE

| PRICE | KR PART # | SIZE | MFG. PART # |
|---------|-----------|---------------------|-------------|
| \$13.48 | VM8GL | Rod End - 1/2" Male | ML8SBZ |



ROD ENDS - MALE THREADED RIGHT HAND WITH ZERK (GREASE FITTING) - 3 PIECE - COMMERCIAL - SINTERED BRONZE

AUTOMATICS HARDWARE

| PRICE | KR PART # | MFG. PART # | SIZE |
|---------|-----------|-------------|------|
| \$14.71 | VM8G | M8SBZ | 1/2" |
| \$19.30 | VM10G | M10SBZ | 5/8" |
| \$25.14 | VM12G | M12SBZ | 3/4" |

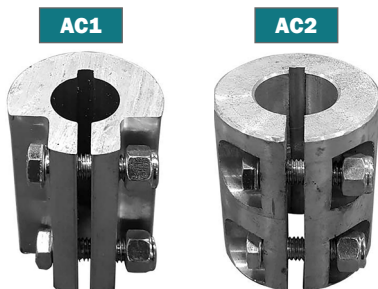

ALUMINUM COUPLERS

AUTOMATICS HARDWARE

- Get a secure connection for your piping to ensure proper liquid transfer for pressure wash applications! A great choice for car washes and other industrial water or wash applications!

| PRICE | PART # | SIZE |
|---------|--------|-------------|
| \$25.54 | AC1 | 1" x 1" |
| \$28.87 | AC2 | 1" x 1 1/4" |

HYDRO-SPRAY WASH SYSTEMS, INC. REPLACEMENT PARTS

CLASSIC & RAINMAKER REPLACEMENT PARTS



6 WIRE CENTER POD ASSEMBLY
REPLACEMENT PARTS

\$1,340.00 HSBA93014

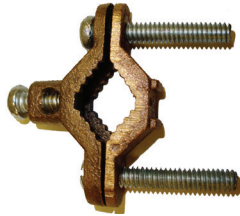

1/2" BRONZE PIPE CLAMP
REPLACEMENT PARTS

\$7.18 HSEF22001



BRUSH ASSEMBLY FOR CENTER POD
REPLACEMENT PARTS

\$35.52 HSBA93015 Center Pod
\$72.45 HSBA93016 Ground



CENTER POD COVER
REPLACEMENT PARTS

\$104.24 HSBA93020



KNIFE DISCONNECT FOR CENTER POD
REPLACEMENT PARTS

\$0.96 HSBA93017



RING W/ WIRE FOR CENTER POD
REPLACEMENT PARTS

\$30.63 HSBA93018

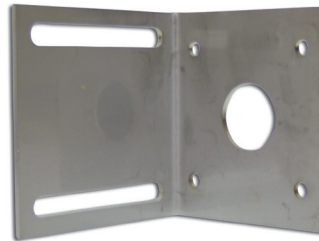

PANCAKE SENSOR MOUNT BRACKET
REPLACEMENT PARTS

\$33.91 HSAP12332



CASTLE NUT
REPLACEMENT PARTS

\$13.15 HSCS82153A



STAINLESS STEEL DRIVE SHAFT INNER DISC
REPLACEMENT PARTS

\$74.00 HSAP12312



STAINLESS STEEL DRIVE SHAFT OUTER DISC
REPLACEMENT PARTS

\$61.58 HSAP12313



1 1/4" BUSHING
REPLACEMENT PARTS

\$27.42 HSBS12018



SPROCKET
REPLACEMENT PARTS

\$22.45 HSBS12017

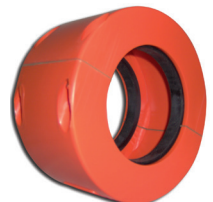

COVER TRACK
REPLACEMENT PARTS

\$130.95 HSBS12019



CHAIN TRACK COUPLING
REPLACEMENT PARTS

\$73.40 HSBS12016



WATER SUPPLY FOR 22 FT. TRACK
REPLACEMENT PARTS

\$1,433.82 HSSA92211



HYDRO-SPRAY WASH SYSTEMS, INC. REPLACEMENT PARTS

RAINMAKER REPLACEMENT PARTS

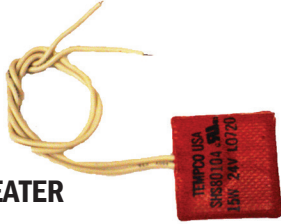

PHOTO EYE HEATER
REPLACEMENT PARTS

\$34.73 HSEC11681



CARRIAGE PILLOW BLOCK BEARING
REPLACEMENT PARTS

\$181.08 HSBS12031



5" GROOVED RUBBER ROLLERSW/ DELRIN SLEEVE
REPLACEMENT PARTS

\$250.71 HSAP12344



BANNER PHOTO EYE EMITTER
REPLACEMENT PARTS

\$244.32 BPS1040

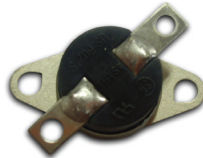

120/250 VAC THERMAL DISC FOR PHOTO EYE HEATERS
REPLACEMENT PARTS

\$15.67 HSEC11679



ENCODER WHEEL PLASTIC W/ STAINLESS STEEL INSERTS
REPLACEMENT PARTS

\$173.57 HSAP12339A



ROLLER SLIDE PLATE
REPLACEMENT PARTS

\$99.64 HSAP12314



CARRIAGE DRIVE SHAFT 38³/₄" x 1¹/₄"
REPLACEMENT PARTS

\$427.50 HSAP12311



PROXIMITY SWITCH FOR TURCK/PNP/MODICON
REPLACEMENT PARTS

\$113.60 TPS1045



CARRIAGE GEAR REDUCER 20:1
REPLACEMENT PARTS

\$1,041.49 HSBS12000

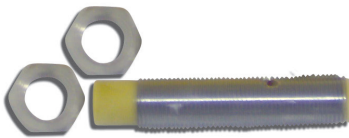

12MM ENCODER FOR TURCK/PNP/MODICON
REPLACEMENT PARTS

\$74.01 HSP11606

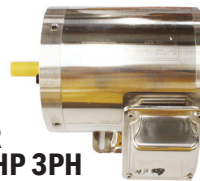

CARRIAGE MOTOR AC WASHDOWN 1HP 3PH
REPLACEMENT PARTS

\$1,025.14 HSEM17236



PHOTO EYE EXTENSION
REPLACEMENT PARTS

\$81.43 HSAP12350



PHOTO EYE HOUSING - TOP
REPLACEMENT PARTS

CALL HSAP12357A



UPRIGHT EXTENSION BRACKET COVER
REPLACEMENT PARTS

CALL HSAP12360



AWG TRAY CABLE WITH PVC JACKET & INSULATION
REPLACEMENT PARTS

- PVC jacketed tray cable
- PVC/nylon insulation
- Class B stranding (ASTM B8)
- Max. Temp: 194°F
- 600 volts
- Suitable for direct burial
- Suitable for NEC class 1 or class 2 locations
- UL type TC-ER
- RoHS compliant
- Fully annealed stranded
- Suitable for exposed run usage per NEC bare copper conductor (ASTM B3) (3 or more conductors)

\$4.90 HSEC11660

HYDRO-SPRAY WASH SYSTEMS, INC. REPLACEMENT PARTS

TOWERS

CLASSIC TOWER

RAINMAKER TOWER

TURBO TOWER



PLEASE MEASURE TRACK BEFORE PLACING YOUR ORDER

Rotating wands result in a superior wash product by completely covering the vehicle's surface with a dynamic scrubbing action. Continuous sizing delivers a safe and quality wash process for every vehicle. Rugged design and quality components deliver an equipment package that will provide quality performance year after year with minimum maintenance and repair.

REPLACEMENT/UPGRADE TOWERS

HYDRO-SPRAY



FAMILIAR UPGRADES

- ABS Tower Cover Set (gray) with decals
- Stainless frame | High pressure nozzle kit | Water supply kit | Extra tube of grease

SYSTEM IMPROVEMENTS

- Low profile rubber coated wands with nozzles
- Stainless quick release latches for easy removal of ABS Tower
- Wash down motor | Mosmatic stainless swivels | Centralized grease system

COVERS FOR MAINTENANCE

- Removable tower covers for easy maintenance

CLASSIC TOWER

HYDRO-SPRAY



| | | |
|--------------------|--------------------|--|
| \$18,044.12 | HSSA95000CL | Classic Tower 3-Phase Electric Classic Yellow Trim & ABS Skins |
| \$1,407.35 | HSSA92210 | Classic Water Supply Kit for 22' Track |
| \$1,433.82 | HSSA92211 | Classic Water Supply Kit for 22'8" Track |

RAINMAKER TOWER

HYDRO-SPRAY



| | | |
|--------------------|---------------------|--|
| \$20,000.00 | HSSA95000R | Rainmaker Tower 3-Phase Electric Rainmaker Blue Trim & ABS Skins |
| \$3,438.31 | HSSA95002-RM | Tower Cover Set with Decals |
| \$1,416.18 | HSSA92209 | Rainmaker Water Supply Kit for Carriage |

TURBO TOWER

HYDRO-SPRAY

| | | |
|--------------------|---------------------|---|
| \$17,466.18 | HSSA95000T-1 | Turbo Tower 1-Phase Electric Turbo Red Trim & ABS Skins |
| \$17,466.18 | HSSA95000T-2 | Turbo Tower 3-Phase Electric Turbo Red Trim & ABS Skins |
| \$1,407.35 | HSSA92207 | Turbo Water Supply Kit for 22' Track |
| \$1,411.76 | HSSA92208 | Turbo Water Supply Kit for 22'8" Track |

CLASSIC & RAINMAKER TOWER PARTS

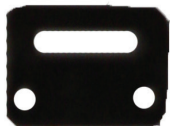

STRIKE PLATE
CLASSIC & RAINMAKER PARTS

\$0.44 HSCS83311X



PBB IDLER PULLEY
CLASSIC & RAINMAKER PARTS

\$52.47 HSBS21055



TENSIONER
CLASSIC & RAINMAKER PARTS

\$109.07 HSBS30319



MOTOR AC WASHDOWN
3/4 HP VENTED
CLASSIC & RAINMAKER PARTS

\$226.49 HSEM17300



LOVEJOY 18 TENSIONER
CLASSIC & RAINMAKER PARTS

\$118.03 FCSE18



STAINLESS BEARING
4 BOLT FLANGE
CLASSIC & RAINMAKER PARTS

\$217.26 HSBS21001



RUBBERIZED WAND
CLASSIC & RAINMAKER PARTS

\$57.78 AM3815MFZ



DOOR CATCH
CLASSIC & RAINMAKER PARTS

\$11.90 HSCS83310X

HYDRO-SPRAY WASH SYSTEMS, INC. REPLACEMENT PARTS

CLASSIC & RAINMAKER TOWER PARTS



HQ 5/8" BUSHING

CLASSIC & RAINMAKER TOWER PARTS

\$18.39 HSBS30026



5/8" BUSHING

CLASSIC & RAINMAKER TOWER PARTS

\$28.55 HSBS30342



RUBBER IDLER ROLLER

CLASSIC & RAINMAKER TOWER PARTS

\$40.20 HSAP92017



TOWER IDLER SHAFT

CLASSIC & RAINMAKER TOWER PARTS

\$285.45 HSAP95131



LOWER HORIZONTAL COVER (BLACK)

CLASSIC & RAINMAKER TOWER PARTS

CALL HSAP95610

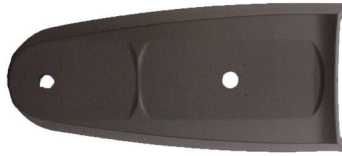

TOWER INSIDE LEG (BLACK)

CLASSIC & RAINMAKER TOWER PARTS

\$633.86 HSAP95615



TOWER OUTSIDE LEG (BLACK)

CLASSIC & RAINMAKER TOWER PARTS

\$670.29 HSAP95620

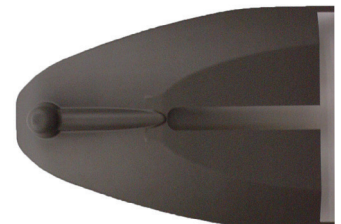

UPPER HORIZONTAL COVER (BLACK)

CLASSIC & RAINMAKER TOWER PARTS

\$491.90 HSAP95605



RUBBER DRIVE ROLLER

CLASSIC & RAINMAKER TOWER PARTS

\$40.20 HSAP92016



1 3/16" SHAFT SPINDLE BEARING

CLASSIC & RAINMAKER TOWER PARTS

\$24.23 HSBS21005F



SPINDLE

CLASSIC & RAINMAKER TOWER PARTS

\$184.61 HSAP95140W 6 1/2"
\$281.79 HSAP95141W 8 1/2"



H40H18 CHAIN SPROCKET

CLASSIC & RAINMAKER TOWER PARTS

\$61.21 HSBS30238

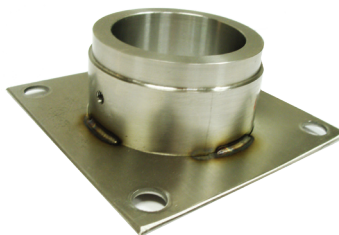

BEARING HOUSING SQUARE

CLASSIC & RAINMAKER TOWER PARTS

\$305.36 HSAP95114



CARRIAGE SPINNER WAND BEARING

CLASSIC & RAINMAKER TOWER PARTS

\$119.39 HSBS21005



TOWER DRIVE SHAFT

CLASSIC & RAINMAKER TOWER PARTS

\$277.00 HSAP95130

HYDRO-SPRAY WASH SYSTEMS, INC. REPLACEMENT PARTS

CLASSIC & RAINMAKER TOWER PARTS

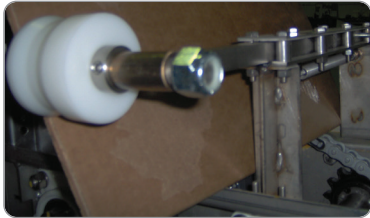

TENSIONER BRACKET ASSEMBLY

RAINMAKER TOWER PARTS

\$427.50 HSSA95197

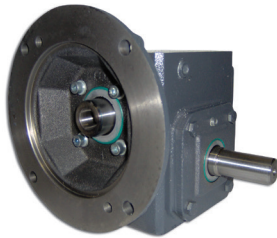

GEARBOX REDUCER

RAINMAKER TOWER PARTS

\$890.31 HSB30495



GUIDE ROLLER

RAINMAKER TOWER PARTS

\$57.77 HSAP92100

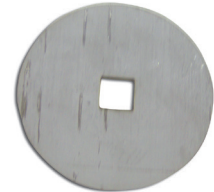

IDLER SHAFT INNER DISC

RAINMAKER TOWER PARTS

\$52.50 HSAP95134

RAINMAKER, CLASSIC & OLDER HYDRO-SPRAY WASH SYSTEM PARTS

MULTI-PURPOSE FOAM GENERATOR

REPLACEMENT PARTS

- PVC Construction
- Maintenance Free
- No Plug Design
- Dual & Single 3/8" Push Lock Inlet Connection
- Single 3/8" Push Lock Outlet Connection



7 1/2" MULTIPURPOSE FOAM GENERATOR

REPLACEMENT PARTS

\$48.11 TFSA001



11 1/2" MULTIPURPOSE FOAM GENERATOR W/ DUAL INLETS

REPLACEMENT PARTS

\$81.89 TFSA005

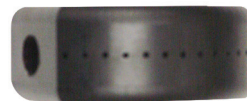

TRI-FOAMER HEAD 13 HOLE UNIT - 3/8" FPT

REPLACEMENT PARTS

\$86.54 HSMPPV48300



TRI-FOAMER HEAD 31 HOLE UNIT - 3/8" FPT

REPLACEMENT PARTS

\$109.81 TF3H31



POWER CORD FOR TOWER 20' - 14 GAUGE - 6 STRAND

REPLACEMENT PARTS

\$86.94 HSAP92198

RAINMAKER, CLASSIC & OLDER HYDRO-SPRAY WASH SYSTEM PARTS



1 CHANNEL MULTIPLEXER

REPLACEMENT PARTS

\$144.69 TPPA0324VDC



1/2 HP 3 PHASE MOTOR

REPLACEMENT PARTS

\$858.53 MWD411



11 PIN SOCKET (TELCO)

REPLACEMENT PARTS

\$8.15 TLR1105



WALL MOUNT HOSE BRACKET FOR AUTO BAY

REPLACEMENT PARTS

\$344.74 HSAP99501

HYDRO-SPRAY WASH SYSTEMS, INC. REPLACEMENT PARTS

RAINMAKER, CLASSIC & OLDER HYDRO-SPRAY WASH SYSTEM PARTS



1 1/4" SPLIT TAPER
REPLACEMENT PARTS

\$9.95 PL0027



3 3/4" OD DOUBLE PULLEY
REPLACEMENT PARTS

\$52.20 PL0150



3 3/4" OD SINGLE PULLEY
REPLACEMENT PARTS

\$33.24 PL0115



CABLE - 20 GA/ 18 COND
REPLACEMENT PARTS

\$4.75 PER FT. HSEC11668

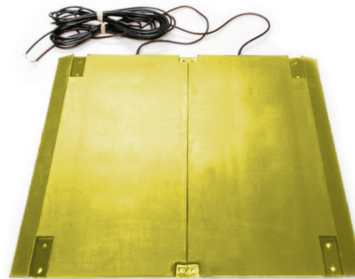

24" X 30" CAR WASH MAT SYSTEM
TAPESWITCH®

TECHNICAL DATA:

- **VOLTAGE:** 24 VAC or DC
- **CURRENT RATING:** 1 Amp
- **ACTUATION FORCE:** 15 lbs. nominal
- **MATERIAL:** Molded PVC
- **MOUNTING:** 4 thru holes on 3/16" steel plate
- **COLOR:** Gray

| PRICE | PART # | DESCRIPTION |
|-----------------|----------------------|---------------------|
| \$560.03 | TSCWRS2430-Y | Mat System - 2 Mats |
| \$280.01 | TSCWRS2430L-Y | LEFT side mat ONLY |
| \$280.01 | TSCWRS2430R-Y | RIGHT side mat ONLY |

REPLACEMENT FOR 2 POSITION RAMPED FLOOR SWITCH PART NUMBER HSP92208

RAINMAKER, CLASSIC & OLDER HYDRO-SPRAY WASH SYSTEM PARTS

COG BELTS REPLACEMENT PARTS



| | | | | | |
|----------------|-----------------|----------------|----------------|----------------|---------------|
| \$34.94 | BLCBX100 | BX100 Cog Belt | \$22.11 | BLCBX61 | BX61 Cog Belt |
| \$15.97 | BLCBX38 | BX38 Cog Belt | \$28.22 | BLCBX84 | BX84 Cog Belt |
| \$20.08 | BLCBX50 | BX50 Cog Belt | | | |

OLD STYLE CLASSIC TOWER PARTS

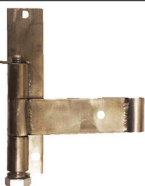

ROLLER GUIDE ARM
OLD STYLE CLASSIC TOWER PARTS

\$264.93 HSAP92011



IDLER SHAFT
OLD TOWER/WELDED PLATE
OLD STYLE CLASSIC TOWER PARTS

\$229.29 HSAP91398



3 HOLE SHORT SPINDLE
OLD TOWER 1/4"
OLD STYLE CLASSIC TOWER PARTS

\$184.61 HSAP92003

DECALS & SIGNS



ATTENTION & DIRECTION
DECALS & SIGNS

\$152.40 HSSN55120



"FOLD IN MIRRORS" DECAL 3 1/2" x 28 3/4"
DECALS & SIGNS

\$21.86 HSSN40050

RGB GUIDE LITES

RGB GUIDE LITES FLOOR MOUNTED GUIDE SYSTEM



Impress your customers with Hydro-Spray's all new RGB Guide Lites! These color changing LED lights will drive impulsive purchases and help prevent accidents from occurring. With a reinforced structure to prevent against tire traffic, RGB Guide Lites are sure to last!

FEATURES:

- White plastic (UHMW) rails
- Color changing Flex Neon
- Custom Length Linear Foot to meet various bay lengths
- Reinforced structure to protect lights from tire traffic
- Low voltage - safe for wet environments
- Plastic guides attach directly to concrete floor
- Synchronizes with in-bay directional signage

BENEFITS

- Alternative to Painted Lines or Reflective Markers
- Faster wash loading
- Reduce customer error
- Help prevent accidents from occurring
- Easy to understand
- Drive Impulsive Purchases
- Quickly captures the attention of the driver



LED LIGHT COLORS



GREEN
ENTER/EXIT



BLUE
BACK UP



RED
STOP

OPTIONS

- Action Lights: Offer chasing/blinking lights for even more curb appeal!
- Green: Front Chasing • Blue: Back Chasing • Red: Solid

ALL PACKAGES INCLUDE:

- Pre-wired Control Panel (requires 110V, 20 Amp receptacle or 120V input depending on the application)
- Pre-programmed controller • Relay control (24V inputs)
- Stainless steel hardware • (2) 2" x 4" junction boxes



24' PACKAGE RGB GUIDE LITES

- 48' RGB Neon Lights
- 48' Custom UHMW Extrusion

\$3,984.38 HSP0324



32' PACKAGE RGB GUIDE LITES

- 64' RGB Neon Lights
- 64' Custom UHMW Extrusion

\$4,920.00 HSP0332



40' PACKAGE RGB GUIDE LITES

- 80' RGB Neon Lights
- 80' Custom UHMW Extrusion

\$5,165.00 HSP0340

WATERPROOF SPEAKER FLOOR MOUNTED GUIDE SYSTEM

The waterproof automated voice attendant comes standard with 8 custom messages to safely guide customers through your wash. This product is more than just a speaker - it comes with a PLC allowing you to tie in features such as laser light shows, email notifications and more!

PRE-PROGRAMMED MESSAGES INCLUDE:

- Please Drive Forward (with three short beeps prior to voice & repeat voice after beep)
- Stop (with single loud beep then voice)
- Back Up (with three short beeps prior to voice & repeat voice after beep)
- Please Exit Wash, Thank you. (with three short beeps prior to voice, do not repeat voice)
- Cleaning Solution Now Being Applied (with single quiet beep prior to voice, do not repeat voice, 5 sec delay once input is received)
- Tri-Color Conditioner Now Being Applied (with single quiet beep prior to voice, do not repeat voice, 5 sec delay once input is received)
- Wax Treatment Now Being Applied (with single quiet beep prior to voice, do not repeat voice, 5 sec delay once input is received)
- Clearcoat Treatment Now Being Applied (with single quiet beep prior to voice, do not repeat voice, 5 sec delay once input is received)



| | | |
|-------------|--------------------|---------|
| CALL | HSP0300-24 | 24 VDC |
| | HSP0300-120 | 120 VDC |

RYKO® REPLACEMENT PARTS

SOFTGLOSS TOP BRUSH PARTS



AIR CYLINDER - 2½" BORE x 8¾" STROKE
RYKO PARTS

\$250.51 RY100



1/4\"T x 1/4\" MPT ELBOW
RYKO PARTS

\$2.76 FT4ME4



**DOUBLE EYE CLEVIS MOUNT
D250 FOR AIR CYLINDER**

RYKO PARTS

| | | |
|----------------|---------|-------------------------------|
| \$32.06 | RY115 | Mount |
| CALL | KITA-01 | 1/2" x 2" Clevis Pin & Cotter |



**SINGLE EYE CLEVIS MOUNT
C250 FOR AIR CYLINDER**

RYKO PARTS

| | | |
|----------------|---------|-------------------------------|
| \$35.38 | RY110 | Mount |
| CALL | KITA-01 | 1/2" x 2" Clevis Pin & Cotter |



**ROD CLEVIS
½-20" UNF THREAD - ½" PIN HOLE**

RYKO PARTS

| | | |
|----------------|---------|-------------------------------|
| \$43.10 | RY105 | Mount |
| CALL | KITA-01 | 1/2" x 2" Clevis Pin & Cotter |



**WEG MOTOR
1 HP/1800 RPM/3PH/56C - 230/460V**

RYKO PARTS

\$419.66 RY385



1" 2-BOLT FLANGE BEARING

RYKO PARTS

\$27.55 UCFT20516



1" DIAMETER FLANGE SHAFT

RYKO PARTS

\$121.34 RY319



**ELECTRA GEAR BOX
SG 25:1 56C LEFT OUTPUT**

RYKO PARTS

\$1,004.20 RY7691



LEFT & RIGHT BEARING BLOCKS

RYKO PARTS

| | | |
|-------------|--------|---------------------|
| CALL | RY240B | Left Bearing Block |
| | RY240A | Right Bearing Block |



**LOVEJOY SPIDER - L110
URETHANE PLASTIC -
1.180" CENTER HOLE DIAMETER**

RYKO PARTS

\$96.43 FCS110U



**LOVEJOY COUPLER - ALUMINUM
HUB WITH KEYWAY - 1" BORE**

RYKO PARTS

\$68.85 LJH417981

CALIFORNIA PROPOSITION 65 NOTE: some items on this page may fall under the Proposition 65 act. Please consult the State of California Proposition 65 list (oehha.ca.gov/proposition-65/proposition-65-list) to learn more and to see a comprehensive list of Proposition 65 chemicals.

RYKO® REPLACEMENT PARTS

SOFTGLOSS FRONT/REAR BRUSH PARTS



AIR CYLINDER - 2½" BORE x 8¾" STROKE
RYKO PARTS

\$250.51 RY100



¼" T x ¼" MPT ELBOW
RYKO PARTS

\$2.76 FT4ME4



DOUBLE EYE CLEVIS MOUNT D250 FOR AIR CYLINDER

RYKO PARTS

| | | |
|----------------|---------|-------------------------------|
| \$32.06 | RY115 | Mount |
| CALL | KITA-01 | 1/2" x 2" Clevis Pin & Cotter |



SINGLE EYE CLEVIS MOUNT C250 FOR AIR CYLINDER

RYKO PARTS

| | | |
|----------------|---------|-------------------------------|
| \$35.38 | RY110 | Mount |
| CALL | KITA-01 | 1/2" x 2" Clevis Pin & Cotter |



ROD CLEVIS ½-20" UNF THREAD - ½" PIN HOLE

RYKO PARTS

| | | |
|----------------|---------|-------------------------------|
| \$43.10 | RY105 | Mount |
| CALL | KITA-01 | 1/2" x 2" Clevis Pin & Cotter |



2-BOLT FLANGE BEARING

RYKO PARTS

| | | |
|----------------|-------|-------------|
| \$49.14 | RY245 | 1½" Bearing |
| \$37.99 | RY240 | 1¼" Bearing |

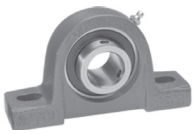

2-BOLT PILLOW BLOCK BEARING 1⅞" - CAST IRON

RYKO PARTS

\$43.58 UCP20723



LOVEJOY COUPLERS

RYKO PARTS

| | | |
|----------------|-----------|----------|
| \$68.85 | LJH417984 | 1¼" Bore |
| CALL | LJH417988 | 1½" Bore |



LOVEJOY SPIDER - L110 URETHANE PLASTIC - 1.180" CENTER HOLE DIAMETER

RYKO PARTS

\$96.43 FCS110U



REAR AND FRONT BRUSH FLANGE SHAFTS - 4-BOLT

RYKO PARTS

| | | |
|-----------------|--------|-----------|
| \$239.89 | RY317B | 1½" x 16" |
| \$154.17 | RY317 | 1¼" x 13" |

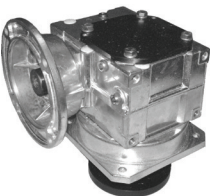

ELECTRA GEARBOX - 25:1 WITH FLANGE

RYKO PARTS

| PRICE | PART # | OUTPUT |
|-----------------|--------|--------|
| \$941.73 | RY769G | Left |
| \$941.73 | RY769H | Right |



ELECTRA GEARBOX - SG 25:1 56C

RYKO PARTS

| PRICE | PART # | OUTPUT |
|-------------------|--------|--------|
| \$1,004.20 | RY769I | Left |
| CALL | RY769J | Right |



WEG MOTOR 1 HP/1800 RPM/3PH/56C - 230/460V

RYKO PARTS

\$419.66 RY385



SIGN UP FOR OUR WEEKLY EMAIL BLAST!

OUR WEEKLY E-BLAST FEATURES:

- Special Sale Offers
- Car Wash Hot Picks
- Featured Videos
- Sign up on the Kleen-Rite website!
- New Product Info
- Industry Calendar



CALIFORNIA PROPOSITION 65 NOTE: some items on this page may fall under the Proposition 65 act. Please consult the State of California Proposition 65 list (oehha.ca.gov/proposition-65/proposition-65-list) to learn more and to see a comprehensive list of Proposition 65 chemicals.

RYKO® REPLACEMENT PARTS

SOFTGLOSS FRONT/REAR BRUSH PARTS (CONTINUED)



BACK-UP

**FOR USE ON AMBER LIGHT ONLY

OVAL LED LIGHTS WITH PLUG 10 LED - 12V RYKO PARTS

| PRICE | PART # | COLOR |
|---------|---------|-----------------|
| \$40.05 | RY404G | Green |
| \$26.64 | RY404R | Red |
| \$26.64 | RY404AM | Amber |
| \$6.61 | RY404D | BACK UP DECAL** |



SOFTGLOSS WHEEL SCRUBBER PARTS



WEG MOTOR 1 HP/1800 RPM/3PH/56C - 230/460V RYKO PARTS

\$419.66 RY385



GEARBOX WITH TRIANGLE HUB 12.5:1 - C-FACE RYKO PARTS

\$892.83 RY769

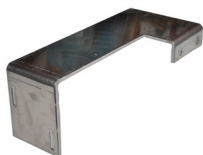

PHOTO EYE BRACKET - LEFT FRONT RYKO PARTS

CALL RY772A



PHOTO EYE BRACKET - RIGHT FRONT RYKO PARTS

CALL RY772



PHOTO EYE BRACKET EXIT RYKO PARTS

\$60.51 RY772B



PROXIMITY SWITCH BRACKET RYKO PARTS

CALL RYRWS50



GREASE PACK FOR CYLINDER RYKO PARTS

\$2.66 SMC500

SOFTGLOSS WHEEL SCRUBBER & GANTRY DRIVE PARTS



BANNER PHOTO EYE EMITTER AND RECEIVER - WIRE CONNECTION - 6.5' LEAD RYKO PARTS

| PRICE | PART # | MFG # | DESC. | POWER |
|----------|---------|----------|----------|-------------------------------------|
| \$262.74 | BPS1110 | SM30PRL | Receiver | 10 - 30 V DC |
| \$244.29 | BPS1115 | SMA30PEL | Emitter | Universal 12 - 240V AC/ 10 - 20V DC |



WEG MOTOR 1 HP/1800 RPM/3PH/56C - 230/460V RYKO PARTS

\$419.66 RY385

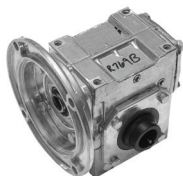

DRIVE GEARBOX HOLLOW SHAFT 30:1 - 1" BORE RYKO PARTS

\$892.83 RY769B



1 1/4" 2 BOLT PILLOW BLOCK BEARING RYKO PARTS

\$55.62 RY241



TORQUE ARM 1/2" ID BORE RYKO PARTS

\$100.16 RY769D



IDLER WHEEL RYKO PARTS

\$237.78 RY170



DRIVE WHEEL RYKO PARTS

\$337.17 RY174



1/4" T x 1/4" MPT ELBOW RYKO PARTS

\$2.76 FT4ME4

CALIFORNIA PROPOSITION 65 NOTE: some items on this page may fall under the Proposition 65 act. Please consult the State of California Proposition 65 list (oehha.ca.gov/proposition-65/proposition-65-list) to learn more and to see a comprehensive list of Proposition 65 chemicals.

RYKO® REPLACEMENT PARTS

SOFTGLOSS ELECTRICAL PANEL PARTS



**ALLEN-BRADLEY 3 POLE CONTACTOR
3 PHASE 24VAC 1 HP**

RYKO PARTS

\$152.02 MS18905



ALLEN-BRADLEY 3 POLE 30 AMP FUSE HOLDER

RYKO PARTS

CALL AB3200



**ALLEN-BRADLEY 3 POLE 32 AMP DRYER
MOTOR OVERLOAD PROTECTOR**

RYKO PARTS

CALL MS18960



**ALLEN-BRADLEY 3 POLE 2½ - 4 AMP
24VAC MOTOR OVERLOAD PROTECTOR**

RYKO PARTS

CALL MS18962



**IDEC 8 BLADE RELAY
½" THICK
24VAC RATED TO 8 AMPS**

RYKO PARTS

\$10.95 IDEC2000



**¾" THICK
SOCKET BASE FOR
8 BLADE RELAY**

RYKO PARTS

\$7.30 IDEC2050



**½" THICK
SOCKET BASE FOR
8 BLADE RELAY**

RYKO PARTS

\$5.81 IDEC2052



**EMERGENCY STOP
PUSH SWITCH -
22MM**

RYKO PARTS

\$50.09 IDEC2020



**ENTRY KEY PAD
8 CONDUCTOR
8 PIN**

RYKO PARTS

\$130.21 RY132



**MERCURY SWITCH
17' WIRES - 24V AC**

RYKO PARTS

\$52.08 RYM131



RECLAIM PARTS



**ALLEN-BRADLEY
3 POLE CONTACTOR - 3 PHASE 24VAC 1 HP**

RYKO PARTS

\$152.02 MS18905



**ALLEN-BRADLEY
3 POLE 6.3-10 AMP 3 PHASE RECLAIM
PUMP OVERLOAD CIRCUIT BREAKER**

RYKO PARTS

CALL MS18964



**J & JB SERIES
STARITE PUMP
57 GPM/2HP
230/460V**

RYKO PARTS

CALL JHG3-52H



**STARITE PUMP
2HP/3PH
230/460V**

RYKO PARTS

CALL AP100GL



**PRESSURE SWITCH
30-50 PSI/24-220V**

RYKO PARTS

\$62.06 ST0328



1" NPT HOSE BARB

RYKO PARTS

\$9.59 BFA29-1616



**PARKER VALVE
DIAPHRAGM
REPAIR KIT**

RYKO PARTS

\$56.09 SOPK360



**2" BRONZE
FOOT VALVE**

RYKO PARTS

\$139.38 4105E

CALIFORNIA PROPOSITION 65 NOTE: some items on this page may fall under the Proposition 65 act. Please consult the State of California Proposition 65 list (oehha.ca.gov/proposition-65/proposition-65-list) to learn more and to see a comprehensive list of Proposition 65 chemicals.

RYKO® REPLACEMENT PARTS

DRYER PARTS



WEG MOTOR
10HP/1800RPM/215T/ODP

RYKO PARTS

CALL RY403



OSCILLATOR AIR CYLINDER
1 1/16" BORE x 1 3/4" BORE

RYKO PARTS

\$87.36 RY251



FLOW CONTROL WITH FITTING
1/8" M x 1/4" T

RYKO PARTS

\$12.23 SMC146-A



FLOW CONTROL NEEDLE VALVE
1/8" MPT X 1/8" F

RYKO PARTS

\$14.53 SMC144



1/4" T x 1/4" MPT ELBOW

RYKO PARTS

\$2.76 FT4ME4



RIGHT SIDE LOUVER

RYKO PARTS

\$160.45 RY252F



LEFT SIDE LOUVER

RYKO PARTS

\$97.82 RY252E

AIR MANIFOLD PARTS



35 SERIES MAC
3 WAY SOLENOID
VALVE - 24V AC -
96" WIRE

RYKO PARTS

\$37.47 MAC2250



35 SERIES MAC
3 WAY SOLENOID
VALVE - 1/8" 24V AC -
96" WIRE

RYKO PARTS

\$33.42 MAC2110



45 SERIES MAC 3
WAY SOLENOID
24V AC BASE

RYKO PARTS

\$49.46 MAC2210



AR20K REGULATOR
1/4" NPT PORTS

RYKO PARTS

\$49.46 SMC102



SMC 1/2" NPT
MINI MODULAR FRL
COMBO UNIT

RYKO PARTS

\$126.86 SMC120



1/4" FPT
EXHAUST VALVE

RYKO PARTS

\$20.41 SMC010

CHEMICAL DISTRIBUTION & BAY SWITCHES



BLUE WHITE PUMP
115V/10.6 OZ/MI

RYKO PARTS

\$356.54 BW15N404X



BLUE WHITE INJECTION
FITTING CHECK VALVE

RYKO PARTS

\$33.11 BWPC395N6A



BLUE VITON FOOT VALVE

RYKO PARTS

\$12.62 IN250020



1/4" ID x 1/2" OD
CERAMIC WEIGHT

RYKO PARTS

\$5.38 IN250006



PRESSURE GAUGE
NON-LIQUID FILLED
1/4" REAR MOUNT

RYKO PARTS

\$5.38 GA100R



1/4" WATER
SEPARATOR WITH
BRACKET

RYKO PARTS

\$104.01 SMC125

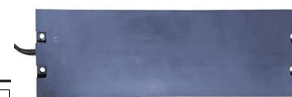

TAPE SWITCH
10" x 32" L
BLUE 20' LEAD

RYKO PARTS

\$219.60 TSCW1032

CALIFORNIA PROPOSITION 65 NOTE: some items on this page may fall under the Proposition 65 act. Please consult the State of California Proposition 65 list (oehha.ca.gov/proposition-65/proposition-65-list) to learn more and to see a comprehensive list of Proposition 65 chemicals.

RYKO® REPLACEMENT PARTS

RG440 CONVEYOR PARTS



PROXIMITY READ SWITCH - VEHICLE DETECTION
RYKO PARTS

\$20.65 SMC020



PROXIMITY READ SWITCH - VEHICLE DETECTION
RYKO PARTS

\$20.65 SMC021



#16 NORMALLY OPEN AIR SWITCH
RYKO PARTS

\$15.80 AS16



3/8" BELL SIGNAL HOSE - .110 WALL
RYKO PARTS

\$1.00 / FT HO0150



LLDPE POLY TUBING - 3/8" / 120PSI / 100FT
RYKO PARTS

\$30.15 PT300BK-100

HYDRAULIC & ELECTRIC DEVICES



2000 SERIES CHAR-LYNN® MOTORS
RYKO PARTS

| PRICE | PART# | DESCRIPTION |
|-----------------|-----------------------|----------------------|
| \$656.86 | CL106-1014-006 | Motor, 18.7 cu"/ Rev |
| \$686.22 | CL106-1015-006 | Motor, 24.9 cu"/ Rev |



1760RPM/182TC 230/460 STERLING MOTOR
RYKO PARTS

| PRICE | PART# | DESCRIPTION |
|-----------------|----------------|-------------|
| \$764.50 | MSE3000 | 3HP |
| \$843.50 | MSE3005 | 5HP |

ROLLERS & CHAINS



PUSHER WHEEL FOR VT2000 & MACNEIL®
4" OD x 1 1/8" ID
RYKO PARTS

\$13.70 RYVT125B



ROLLER FOR VT2000 & MACNEIL®
2 3/4" OD x 2 1/4" ID
RYKO PARTS

\$15.95 RYVT125A



CARRIER LINK
RYKO PARTS

\$25.61 CLX348



BAR
RYKO PARTS

\$4.75 X458BAR



PIN
RYKO PARTS

\$2.40 X458PIN



REPLACEMENT ROLLER
RYKO PARTS

- Welded shaft

\$117.67 RYKO100



RTP



RIW

REPLACEMENT PARTS
RYKO PARTS

| | | |
|----------------|------------|----------------------|
| \$47.12 | RTP | Pusher - No Shoulder |
| \$17.72 | RIW | Idler - Shoulder |



CHAIN SECTIONS
RYKO PARTS

- Sold in 10 ft. sections - PRICE IS PER 10 FEET

\$102.10 X458



BAR
RYKO PARTS

\$4.75 X458BAR



PIN
RYKO PARTS

\$2.40 X458PIN



CENTER LINK
RYKO PARTS

\$3.85 X458LINK

CALIFORNIA PROPOSITION 65 NOTE: some items on this page may fall under the Proposition 65 act. Please consult the State of California Proposition 65 list (oehha.ca.gov/proposition-65/proposition-65-list) to learn more and to see a comprehensive list of Proposition 65 chemicals.

RYKO® POPULAR REPLACEMENT PARTS



WEG MOTOR - TEFC 1 HP/1800 RPM/3PH/56C - 230/460V RYKO PARTS

- Drive for R7B, VOY II, Softgloss, US2001, VT2000 Wrap, Wheel Scrubber, Nova, 2000, Trolley & Rotate on Mon. Hi Impact, w/Blaster on Some Softgloss

\$419.66 RY385



GEAR BOX RYKO PARTS

- Left Front, 25 -1, Flange Shaft, L. Output, Softgloss, Left on Nova & Left Rocker on VT2000

\$941.73 RY769G

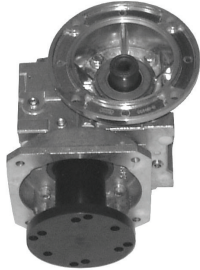

GEAR BOX RYKO PARTS

- Right Front, 25 -1, Flange Shaft, R. Output, Softgloss, Right on Nova 2000, Right & Left on Wrap VT2000, Right Rocker, On VT2000

\$941.73 RY769H



DRIVE WHEEL GEAR BOX RYKO PARTS

- Voyager II, Monarch II, Some Softgloss XS
- 6 Month Warranty

\$892.83 RY769B



GEAR BOX RYKO PARTS

- For Foam Brite 30" Right Front, Tall Left Rear Brush, Top Brush, 1", L. Output, 25-1, VOY II, Softgloss XS, VT2000, Rocket, Select-A-Wash

\$1,004.20 RY769I



GEAR BOX RYKO PARTS

- For Foam Brite, 30" Left Front, Right Rear Tall Brush, 1", R. Output, 25-1, VOY II, Softgloss

\$898.35 RY769J



30mm PROXIMITY SWITCH WITH 23' CABLE RYKO PARTS

- For Monarch II Hi Impact, Monarch II Hi Pressure Voyager, Voyager II, VT2000, Softgloss, and Select-a-Wash

\$74.26 RY775

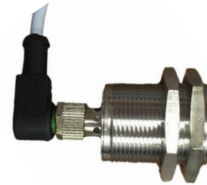

PROXIMITY SWITCH RYKO PARTS

- For VT2000, Impact, OHD, 14526-26

\$99.34 RY776



GANTRY TIMING BELT RYKO PARTS

- 1" x 28". Long, runs full length of track on both sides, pulls gantry

\$428.85 RYRUS45

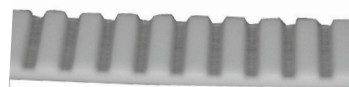

TROLLEY TIMING BELT RYKO PARTS

- 1" x 167". Long, pulls trolley from left to right

\$216.50 RYRUS40



COMPLETE TREADLE RYKO PARTS

\$478.65 RYM220 Right Side
\$478.65 RYM240 Left Side



DRIVE SPROCKET RYKO PARTS

- Built before 2002, for VT2000 and MacNeil.

\$173.77 RYVT150



2-BOLT BEARING RYKO REPLACEMENT PARTS

| PRICE | PART | DESCRIPTION |
|----------------|-----------|--|
| \$27.55 | UCFT20516 | 1", For Top Brush, All Machines |
| \$37.99 | RY240 | 1 1/4", For Drive Wheel, R7B, Voyager, Front Brush Shafts/All Machines Except 42" on SoftGloss XS. |
| \$49.14 | RY245 | 1 1/2", For All Tall Rear Brushes |



2-BOLT BEARING RYKO REPLACEMENT PARTS

- Pillow block bearing 1 1/4" wheel bearing for Voyager II, SoftGloss XS and Select-a-Wash

\$55.62 RY241

CALIFORNIA PROPOSITION 65 NOTE: some items on this page may fall under the Proposition 65 act. Please consult the State of California Proposition 65 list (oehha.ca.gov/proposition-65/proposition-65-list) to learn more and to see a comprehensive list of Proposition 65 chemicals.

RYKO® POPULAR REPLACEMENT PARTS



AIR SOLENOID RYKO REPLACEMENT PARTS

- Air Solenoid, Mac Valve 35A-B00-DACA-1BA for most functions on Voyager II, SoftGloss XS, Select-A-Wash

\$58.02 RY506A



AIR SOLENOID BLOWER OSCILLATOR RYKO REPLACEMENT PARTS

- Air Solenoid, Mac Valve 45A-L00-DACA-1BA for Voyager II, SoftGloss XS, Select-A-Wash

\$66.39 RY504



MAC-REGULATOR RYKO REPLACEMENT PARTS

- Left side of air manifold
- Voyager II, SoftGloss XS, Select-A-Wash

\$46.23 RY506B



TREADLE SPRING STAINLESS STEEL RYKO REPLACEMENT PARTS

- Left or Right side, lifts trip bar for Voyager II, SoftGloss XS, Select-a-Wash

\$20.26 RYM129

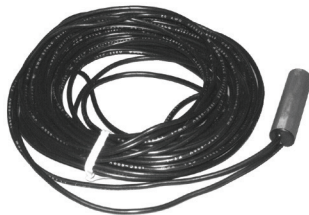

MERCURY SWITCH W/ 17' WIRES RYKO REPLACEMENT PARTS

- Treadle switch, attaches to trip bar for all machines

\$52.08 RYM131



TORQUE ARM RYKO REPLACEMENT PARTS

- Attaches to and secures drive wheel gearbox on most machines
- Hot dipped

\$100.16 RY769D



AIR CYLINDER RYKO REPLACEMENT PARTS

- All machines & Thrust Pro Dryer
Follower Nozzle Lift

\$250.51 RY100



TOUCH PAD RYKO REPLACEMENT PARTS

- With "D" plug, entry system. Used in a multi-upgrade coin box.

\$179.71 RY130



BRUSH SHAFT RYKO REPLACEMENT PARTS

| PRICE | PART | SIZE | USAGE |
|-----------------|--------------|------|---|
| \$242.30 | RY310 | 1¼" | Front Side Brush Shaft. Except 42" on SoftGloss XS. Select-A-Wash |
| \$270.63 | RY315 | 1½" | Tall Rear Brush Shaft. All Machines. |
| \$176.65 | RY320 | 1" | Top Brush Shaft- All Machines, Except SoftGloss XS, Select-A-Wash |



"THE ORIGINAL NEOGLIDE" RYKO REPLACEMENT PARTS

- Neoglide Foam Brush Retro Kits - Convert any bristle machine with this easy to install slide in C-Channel design. Extremely gentle, soft and durable. 75% lighter than cloth means longer life for equipment! No water or grit absorption!
- **ALL HARDWARE INCLUDED**

| PART | MACHINE | DESCRIPTION |
|---------------|---|---|
| RYNE01 | R7B MACHINE with nylon bristle brushes | (4) 33" side brushes, 66" top brush, (2) 5" window brushes |
| RYNE02 | R7B MACHINE with nylon bristle brushes | (2) 33" front side brushes, (2) 70" tall rear & 66" top brush |
| RYNE03 | VOYAGER with nylon bristle brushes | (2) 33" front side brushes, (2) 70" tall rear & 66" top brush |
| RYNE04 | VOYAGER II with nylon bristle brushes | (2) 33" front side brushes, (2) 70" tall rear & 66" top brush |
| RYNE05 | VOYAGER II with cloth of Foambrite brushes | (2) 33" front side brushes, (2) 70" tall rear & 66" top brush |
| RYNE06 | SOFTGLOSS XS with Foambrite brushes | (2) 33" front side brushes, (2) 70" tall rear & 66" top brush |
| RYNE07 | SOFTGLOSS XS OR MAXX with Foambrite brushes | (2) 44" front side brushes, (2) 70" tall rear & 66" top brush |

CALL FOR PRICING

CALIFORNIA PROPOSITION 65 NOTE: some items on this page may fall under the Proposition 65 act. Please consult the State of California Proposition 65 list (oehha.ca.gov/proposition-65/proposition-65-list) to learn more and to see a comprehensive list of Proposition 65 chemicals.

RYKO® POPULAR REPLACEMENT PARTS



WATER VALVE RYKO REPLACEMENT PARTS

- Aquamatic, 1" NC, for R7B, Voyager

\$256.57 RY161



WATER VALVE RYKO REPLACEMENT PARTS

- Air operated Aquamatic, 1" with 1/4" Side Tap. Supplies water to car wash

\$268.46 RY160



WATER VALVE REPAIR KIT RYKO REPLACEMENT PARTS

- For Aquamatic, 1" (RY160 & RY161)

\$56.69 RY165



DRIVE WHEEL RYKO REPLACEMENT PARTS

- Used on R7B and Voyager car washes only.

\$283.36 RY169

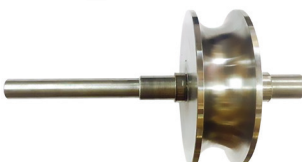

DRIVE WHEEL RYKO REPLACEMENT PARTS

- For Voyager II, SoftGloss XS, Monarch II, U.S. 201, Select-A-Wash.

\$337.17 RY174



IDLER WHEEL RYKO REPLACEMENT PARTS

- For ALL RYKO® machines

\$237.78 RY170



SINGLE EYE MOUNT RYKO REPLACEMENT PARTS

- Two used on each brush air cylinder

\$35.38 RY110



DOUBLE EYE MOUNT RYKO REPLACEMENT PARTS

- Bolts to rear end of brushair cylinder

\$32.06 RY115



ROD CLEVIS PIN RYKO REPLACEMENT PARTS

- Stainless steel pin used to connect both bolt ends of brush air cylinder to mounts.

\$7.62 RY120



ROD CLEVIS RYKO REPLACEMENT PARTS

- Used on all brushes EXCEPT wheel scrubbers

\$43.10 RY105



REPLACEMENT DUAL ROLLER ASSEMBLY RYKO REPLACEMENT PARTS

- For VT2000 and Rocket conveyors built AFTER 2002
- Yellow and black
- UHMW polyethylene
- Dual assembly style

\$110.57 VTR320

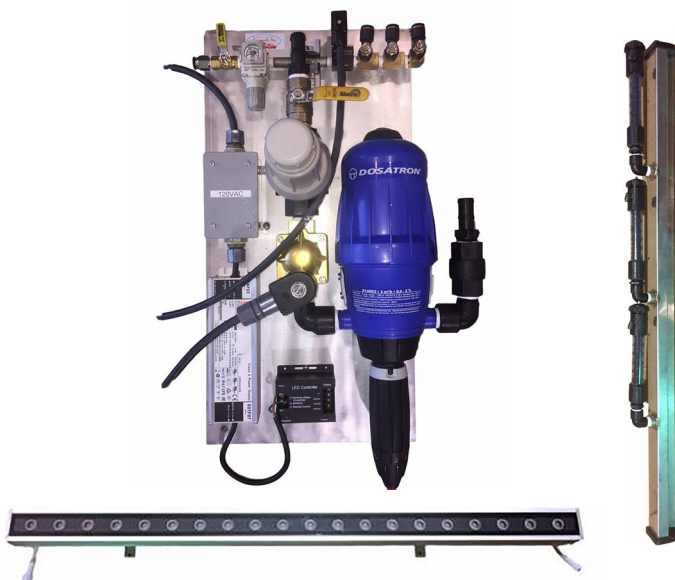

TUNNEL LAVA KIT RYKO REPLACEMENT PARTS

- The Ryko FOAM12 Lava Lather kit creates a visually stunning display in your automatic tunnel! This complete kit works with your existing Ryko Softgloss XS, Maxx, or Voyager II system to give the appearance of a hot sheet of lava coming down to wax and shine your customers' cars.

THE LAVA LATHER KIT INCLUDES:

- 70" stainless steel lava unit
- Dosatron pump panel
- 40" multicolored LED light bar
- All required installation materials

\$4,110.48 FOAM12

CALIFORNIA PROPOSITION 65 NOTE: some items on this page may fall under the Proposition 65 act. Please consult the State of California Proposition 65 list (oehha.ca.gov/proposition-65/proposition-65-list) to learn more and to see a comprehensive list of Proposition 65 chemicals.

SONNY'S® CONVEYOR CONTROL SYSTEMS

PHOTO EYES



PANTRON 24VAC & 115VAC PHOTO EYE KIT WITHOUT STANDS
SONNY'S PARTS

| | | |
|-----------------|---------------------|--------|
| \$329.83 | PPSK0015-24 | 24VAC |
| \$329.83 | PPSK0015-115 | 115VAC |



PANTRON ISG-A124 SERIES AUTOMATIC TEST AMPLIFIERS
SONNY'S PARTS

| | | |
|-----------------|---------------------|--------|
| \$172.07 | PPSA0124-24 | 24VAC |
| \$172.07 | PPSA0124-115 | 115VAC |



PPSR1005



PPSR1015

PANTRON M12 SERIES TRANSMITTERS & RECEIVERS
SONNY'S PARTS

- Nickel plated brass

| PRICE | PART # | TYPE | DESC. |
|-----------------|--------------------|--------------------------|---------------|
| \$107.07 | PPSR1005 | Receiver | 49 ft Cable |
| \$71.28 | PPST1005 | Transmitter | 49 ft Cable |
| \$150.51 | PPSR1010 | Receiver | 114 ft Cable |
| \$58.02 | PPSR1015 | Receiver | M12 Connector |
| \$53.09 | PPST1015-HP | High Powered Transmitter | M12 Connector |



PANTRON M12 RIGHT ANGLE FEMALE CABLE
SONNY'S PARTS

- 3 wire
- 114 ft

\$53.37 **PPSC2000-35**

TAPE SWITCHES



TAPESWITCH MOLDED PVC RAMPED FLOOR SWITCH 9" W x 32" L
SONNY'S PARTS

- 24 VAC or DC - 1 Amp
- Actuation Force: 15 lbs nominal
- Mounting: 4 thru holes on 3/16" steel plate

\$181.78 **TSCW932R**

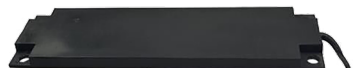

TAPESWITCH MOLDED PVC REGULAR FLOOR SWITCHES 5" W x 32" L
SONNY'S PARTS

- 24 VAC or DC - 1 Amp
- Actuation Force: 15 lbs nominal
- Mounting: 4 thru holes on 3/16" steel plate
- AWG dri-run cable

| PRICE | PART # | CABLE |
|-----------------|-------------------|-------|
| \$131.76 | TSCW532 | 20 ft |
| \$151.50 | TSCW532-50 | 50 ft |

GO® SWITCH



GO®SWITCH MAGNET-ACTUATED
SONNY'S PARTS

- Can run AC or DC - Can be wired Normally-Open (N/O) or Normally-Closed (N/C)

\$272.00 **GO1100**



GO®SWITCH AMC4 - MAGNET ONLY
SONNY'S PARTS

\$31.00 **GO1100-M**



GO®SWITCH ABS3 FLAT BRACKET PLATE
SONNY'S PARTS

\$36.00 **GO1100-BP**

BELL HOSE TIRE SWITCH



BELL SIGNAL HOSE
SONNY'S PARTS

- 3/8" hose
- .110 wall

\$1.00 / FT **H00150**



LLDPE POLY TUBING
SONNY'S PARTS

- 3/8" hose
- 120 PSI
- 100 ft

\$30.15 **PT300BK-100**



#16 NORMALLY OPEN AIR SWITCH
SONNY'S PARTS

\$15.80 **AS16**



CALIFORNIA PROPOSITION 65 NOTE: some items on this page may fall under the Proposition 65 act. Please consult the State of California Proposition 65 list (oehha.ca.gov/proposition-65/proposition-65-list) to learn more and to see a comprehensive list of Proposition 65 chemicals.

SONNY'S® OVER UNDER AIR TAKE-UP CONVEYORS

AIR TAKE-UP ENTRANCE PARTS



1 15/16" 2-BOLT FLANGE BEARING
SONNY'S PARTS

\$66.66 UCFT21031



12T 10 3/16" SHAFT TAKE UP SPROCKET
SONNY'S PARTS

\$89.99 SPROCK-TU12SON

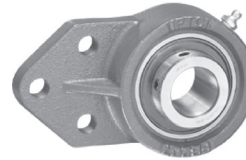

1 1/4" 3 BOLT FLANGE BEARING WITH SET SCREW LOCK
SONNY'S PARTS

| PRICE | KR PART # | MFG. # |
|----------------|------------------|------------|
| \$46.57 | UCFB20720 | UCFB207-20 |

CONVEYOR ENTRANCE PARTS



PARKER LOW PRESSURE SWITCH 30-75 PSI
SONNY'S PARTS

\$113.89 PS1P1091



X458 CHAIN



CHAIN SECTIONS
SONNY'S PARTS

• Sold in 10 ft. sections - Price is per 10 feet.

\$102.10 PER 10 FT. X458



BAR
SONNY'S PARTS

\$4.75 X458BAR



PIN
SONNY'S PARTS

\$2.40 X458PIN



CENTER LINK
SONNY'S PARTS

\$3.85 X458LINK



CARRIER LINK
SONNY'S PARTS

\$22.06 CLX458-M2



2 1/4" TAPERED LOCK BUSHINGS
SONNY'S PARTS

\$41.64 TLB2517-214

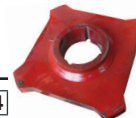

4-TOOTH SPROCKET FOR X4583
SONNY'S PARTS

\$139.00 SPROCKET458

LOG CHAIN



LOG CHAIN (3 1/2" PITCH)
SONNY'S PARTS

• Heat treated

\$8.75 LOGCH



2 1/4" TAPERED LOCK BUSHINGS
SONNY'S PARTS

\$41.64 TLB2517-214

SC78 CHAIN



SC78 & SC78PC (PITCH 2.609")
SONNY'S PARTS

• Riveted pin & cotter • 16 Pitch Sections

| | | |
|----------------|------------------|--------------------|
| \$37.69 | SC78-16 | Riveted Chain |
| \$39.15 | SC78PC-16 | Pin & Cotter Chain |



PIN & COTTER
SONNY'S PARTS

\$2.75 SC78P

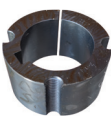

2 1/4" TAPERED LOCK BUSHINGS
SONNY'S PARTS

\$41.64 TLB2517-214



M2 LINKS
SONNY'S PARTS

\$11.05 SC78M2



12T 10 3/16" SHAFT TAKE UP SPROCKET
SONNY'S PARTS

\$89.99 SPROCK-TU12SON



12 TOOTH SPROCKET
SONNY'S PARTS

\$122.99 SPROCKET12

SPRING TAKE-UP ENTRANCE PARTS



1 15/16" 2-BOLT FLANGE BEARING
SONNY'S PARTS

\$66.66 UCFT21031



12T 10 3/16" SHAFT TAKE UP SPROCKET
SONNY'S PARTS

\$89.99 SPROCK-TU12SON

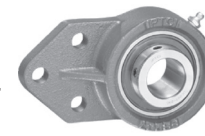

1 1/4" 3 BOLT FLANGE BEARING WITH SET SCREW LOCK
SONNY'S PARTS

2 NEEDED

| PRICE | KR PART # | MFG. # |
|----------------|------------------|------------|
| \$46.57 | UCFB20720 | UCFB207-20 |

CALIFORNIA PROPOSITION 65 NOTE: some items on this page may fall under the Proposition 65 act. Please consult the State of California Proposition 65 list (oehha.ca.gov/proposition-65/proposition-65-list) to learn more and to see a comprehensive list of Proposition 65 chemicals.

SONNY'S® OVER UNDER AIR OR SPRING TAKE-UP CONVEYORS

EXIT MOTOR DRIVE OPTIONS

HYDRAULIC



2 1/4" TAPERED LOCK BUSHINGS
SONNY'S PARTS

\$41.64 TLB2517-214



12-TOOTH SPROCKET
SONNY'S PARTS

\$122.99 SPROCKET12

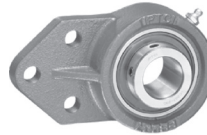

1 1/4" 3-BOLT FLANGE BEARING WITH SET SCREW LOCK
SONNY'S PARTS

| PRICE | KR PART # | MFG. # |
|----------------|-----------|------------|
| \$46.57 | UCFB20720 | UCFB207-20 |



FOUR BOLT CENTER FLANGE GEARBOX FOR CHAR-LYNN MOTORS
SONNY'S PARTS

\$1,310.59 HECO-9010



2000 SERIES CHAR-LYNN® MOTORS
SONNY'S PARTS

| PRICE | PART# | DESCRIPTION |
|-----------------|----------------|----------------------|
| \$617.13 | CL106-1012-006 | Motor, 11.9 cu"/ Rev |
| \$656.86 | CL106-1014-006 | Motor, 18.7 cu"/ Rev |

ELECTRIC



2 1/4" TAPERED LOCK BUSHINGS
SONNY'S PARTS

\$41.64 TLB2517-214



12-TOOTH SPROCKET
SONNY'S PARTS

\$122.99 SPROCKET12

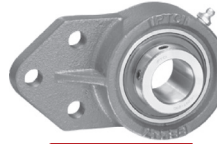

1 1/4" 3-BOLT FLANGE BEARING WITH SET SCREW LOCK
SONNY'S PARTS

| PRICE | KR PART # | MFG. # |
|----------------|-----------|------------|
| \$46.57 | UCFB20720 | UCFB207-20 |

2 NEEDED

OTHER



3HP/1760RPM/182TC 230/460 STERLING MOTOR
SONNY'S PARTS

\$764.50 MSE3000



SUNGEAR INPUT SHAFT ADAPTER FOR CHAR-LYNN 2000 BEARING-LESS MOTOR
SONNY'S PARTS

\$139.16 HECO-7276

SONNY'S® SURFACE CONVEYOR | OVER UNDER SHALLOW PIT CONVEYOR

CONVEYOR PARTS



LOG CHAIN (3 1/2" PITCH)
SONNY'S PARTS

- Heat treated

\$8.75 LOGCH

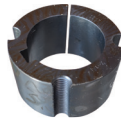

2 1/4" TAPERED LOCK BUSHINGS
SONNY'S PARTS

\$41.64 TLB2517-214



3/8" F X F BRASS HIGH PRESSURE CHECK VALVE
SONNY'S PARTS

- Maximum 2000 PSI
- 8 GPM

\$44.41 CV0043



2000 SERIES CHAR-LYNN® MOTOR
SONNY'S PARTS

| PRICE | PART# |
|----------------------|----------------|
| \$656.86 | CL106-1014-006 |
| Motor, 18.7 cu"/ Rev | |



90° ELBOW 1/4" NPTM x 3/8" TUBE KQ2 ONE-TOUCH FITTINGS - PACK OF 10
SONNY'S PARTS

| PRICE | KR # | SMC # |
|----------------|----------|-------------|
| \$26.74 | FME-0406 | KQ2L11-35AS |



SUNGEAR INPUT SHAFT ADAPTER FOR CHAR-LYNN 2000 BEARING-LESS MOTOR
SONNY'S PARTS

\$139.16 HECO-7276

CALIFORNIA PROPOSITION 65 NOTE: some items on this page may fall under the Proposition 65 act. Please consult the State of California Proposition 65 list (oehha.ca.gov/proposition-65/proposition-65-list) to learn more and to see a comprehensive list of Proposition 65 chemicals.

SONNY'S® PRESOAK APPLICATORS

FOAMING

EASY CLEAN FOAMER PARTS



1/4" K-15 PVC FLOODJET NOZZLE
SONNY'S PARTS

\$16.09 SNFJ04K15PVC



90° ELBOW 1/2" NPTM x 1/2" TUBE KQ2 ONE-TOUCH FITTINGS - PACK OF 10
SONNY'S PARTS

| PRICE | KR # | SMC # |
|----------------|----------|-------------|
| \$38.64 | FME-0808 | KQ2L13-37AS |

California Proposition 65

STANDARD FOAMER PARTS



1 5/8" I.D. STAINLESS STEEL CUSH-A-CLAMP
SONNY'S PARTS

\$34.49 CLO26NS030 California Proposition 65

SONNY'S® CTA TIRE & WHEEL APPLICATORS

NON-FOAMING & FOAMING

NON-FOAMING CTAS



1/4" NPT(M) 125 PSI CHECK VALVE
SONNY'S PARTS

\$6.99 SN836014NYBL

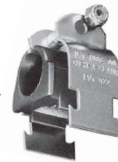

1/2" I.D. STAINLESS STEEL CUSH-A-CLAMP
SONNY'S PARTS

\$20.69 CLS14NS018 California Proposition 65

FOAMING CTAS



1 3/8" I.D. STAINLESS STEEL CUSH-A-CLAMP
SONNY'S PARTS

\$29.86 CLS22NS026 California Proposition 65

SONNY'S® PRESSURE GUN UNITS

DIRECT DRIVE & BELT DRIVEN UNITS

DIRECT DRIVE PUMPS

BELT DRIVEN PUMPS - CAT PUMPS®

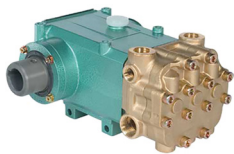

ARIMITSU 510 LEFT SHAFT PUMP
SONNY'S PARTS

- 28 mm
- 7.5 GPM
- 1800 RPM
- 1200 PSI

\$881.54 ARM510L



CAT PUMPS 7CP6170 BRASS MANIFOLD BELT DRIVE PLUNGER PUMP
SONNY'S PARTS

- 11 GPM
- 24 mm shaft
- 1450 RPM
- 2000 PSI

\$1,725.44 PU7CP6170



CAT PUMPS RAIL ASSEMBLY
SONNY'S PARTS

\$46.57 PU30613



PULSATION DAMPENERS
SONNY'S PARTS

- 10 GPM
- 1/2" MNPT

\$80.18 PDK103 HAZARDOUS MATERIAL

BELT DRIVEN PUMPS - WANNER



D10-X HYDRA-CELL PUMP
SONNY'S PARTS

- **MAX FLOW:** .1 GPM
- **MAX TEMP:** 250°F.
- **INLET:** 1" NPT
- **WEIGHT:** 48 lbs.
- **SHAFT DIAMETER:** 7/8"
- **SHAFT ROTATION:** Bi-directional
- **MAX PSI:** 1000
- **MAX RPM:** 1450
- **OUTLET:** 3/4" NPT

\$1,370.85 D10XKBTHFECA



REGULATOR
SONNY'S PARTS

- **MAX FLOW:** 3-10 GPM
- **MAX PSI:** 500-1000
- **MAX TEMP:** 200°F.
- **INLET:** 3/4"
- **OUTLET:** F3/4"

\$265.20 WPC22ABBNSSEF

CALIFORNIA PROPOSITION 65 NOTE: some items on this page may fall under the Proposition 65 act. Please consult the State of California Proposition 65 list (oehha.ca.gov/proposition-65/proposition-65-list) to learn more and to see a comprehensive list of Proposition 65 chemicals.

SONNY'S® PRESSURE GUN UNITS - CONTINUED

DIRECT DRIVE & BELT DRIVEN UNITS - CONTINUED

BELT DRIVEN PUMPS - ARIMITSU

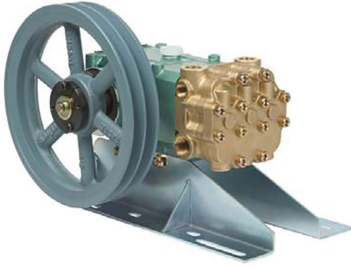

ARIMITSU 508 LEFT SHAFT PUMP
SONNY'S PARTS

- 9-3/4" double groove pulley
- 8 GPM @ 950 RPM, 0 - 1200 PSI
- 10 GPM @ 1200 RPM, 0 - 1000 PSI

| | | |
|-------------------|-----------------|------------------|
| \$1,082.23 | ARM61004 | PUMP SET |
| \$886.69 | ARM508L | PUMP ONLY |



9 3/4" 2 GROOVE SHEAVE
SONNY'S PARTS

| | |
|-----------------|------------------|
| \$116.82 | ARM2MBL97 |
|-----------------|------------------|



2mm BUSHING FOR 5 SERIES
SONNY'S PARTS

| | |
|----------------|-----------------|
| \$19.76 | ARMLX22A |
|----------------|-----------------|

BELT DRIVEN PUMPS - COMMON PARTS



GIANT UNLOADER - YELLOW SPRING
SONNY'S PARTS

- | | |
|--|------------------------------------|
| • PSI: 375 - 1400 | • MAX. TEMP: 160°F |
| • INLET: 1/2" FPT | • OUTLET: 1/2" FPT |
| • BYPASS: 1/2" FPT | • ACCESSORY PORTS: 4 x 1/4" |
| • FLOW: 2.2 - 13.0 GPM | • HOUSING: Bronze |
| • MATERIALS: Stainless steel wetted | |
| • USE: CAT & Arimitsu pumps | |

| | |
|----------------|----------------|
| \$95.56 | PU22911 |
|----------------|----------------|



45" PITCH 48" O.D. V-BELT
SONNY'S PARTS

| | |
|----------------|---------------|
| \$14.11 | BLOB45 |
|----------------|---------------|

PRESSURE GUN STATION PARTS



40 GALLON RECTANGULAR STORAGE TANK
SONNY'S PARTS

| | | |
|-----------------|-------------------|-------------|
| \$581.56 | SOT0040 | TANK |
| \$124.62 | SOT0040LID | LID |



9 GPM HYDROMINDER WITH SIPHON BEAKER & MOUNTING BRACKET
SONNY'S PARTS

| | |
|-----------------|--------------|
| \$301.08 | IN530 |
|-----------------|--------------|



1/4" LIQUID FILLED BOTTOM MOUNT PRESSURE GAUGE
SONNY'S PARTS

- 0 - 2000 PSI

| | |
|----------------|-----------------|
| \$14.11 | GAL2000B |
|----------------|-----------------|

SPRAY GUN & HOSE ASSEMBLY PARTS



MV925 NON-WEEP GUN & GUN WITH LANCE EXTENSION
SONNY'S PARTS

- | | |
|----------------------------|--------------------------|
| • MAX FLOW: 8.0 GPM | • MAX PSI: 4500 |
| • MAX TEMP.: 320°F | • INLET: 3/8" FPT |
| • OUTLET: 1/4" FPT | |

| PRICE | PART # | DESCRIPTION |
|----------------|-------------------|------------------------------|
| \$20.88 | MV925 | Gun Only |
| \$31.33 | MV925-MV70 | Gun with 14" Lance Extension |

1/4" MPT CHROME PLATED WANDS WITH MOLDED GRIP
SONNY'S PARTS

| PRICE | PART # | LENGTH |
|---------------|-------------------|--------|
| \$5.21 | WTZ418MMWL | 18" |
| \$6.14 | WTZ424MMWL | 24" |

3/8" x 20' HOSE ASSEMBLY
SONNY'S PARTS

| | |
|----------------|---------------------|
| \$37.84 | HA206WBK1414 |
|----------------|---------------------|



1/4" NOZZLE PROTECTOR
SONNY'S PARTS

| | |
|---------------|--------------|
| \$3.08 | NP114 |
|---------------|--------------|



SA 1/4" MEG-2507 WASH JET NOZZLE
SONNY'S PARTS

- 3 GPM • 25° spray angle

| | |
|---------------|-----------------|
| \$5.51 | SN2507M4 |
|---------------|-----------------|



3/8" FPT QUICK CONNECT SOCKET
SONNY'S PARTS

- Stainless steel

| | |
|---------------|---------------|
| \$8.91 | HF0375 |
|---------------|---------------|



3/8" MPT QUICK CONNECT PLUG
SONNY'S PARTS

- Stainless steel

| | |
|---------------|---------------|
| \$8.91 | HF0376 |
|---------------|---------------|

PRESSURE GUN WAND HOLDERS



FLOOR MOUNT STAINLESS STEEL FLEXIBLE WAND HOLDER
SONNY'S PARTS

| | |
|----------------|----------------|
| \$62.75 | KRV1216 |
|----------------|----------------|

SONNY'S® TBG200 TIRE & WHEEL BRUSHES

POODLE PLUS, BISON, NINJA

TBG200 HYDRAULIC



AMI BEARING 2-BOLT WITH CAP 1 1/4"
SONNY'S PARTS

\$46.57 UCPA20720



1 1/4" 5-BOLT TIRE BRUSH SPINDLE
SONNY'S PARTS

\$79.58 UBA42016



1" x 1" SPLIT ALUMINUM COUPLERS
SONNY'S PARTS

\$25.54 AC1



TE SERIES 887 RPM PARKER HYDRAULIC TORQMOTOR™
SONNY'S PARTS

\$545.53 PM1250



TC SERIES 688 RPM PARKER HYDRAULIC MOTOR
SONNY'S PARTS

\$412.26 PM1225

POODLE BRUSH PLUS - HYDRAULIC & ELECTRIC



96" BOLT ADAPTER POODLE PLUS BRUSH WITH SPINDLES
SONNY'S PARTS

| PRICE | PART # | COLOR |
|-----------------|---------|-------|
| \$994.89 | UB500BK | Black |
| \$994.89 | UB500BL | Blue |
| \$994.89 | UB500R | Red |

**WE ARE ALWAYS EXPANDING
OUR REPLACEMENT
PART INVENTORY!**

Visit our website for the most up-to-date listings of Sonny's® replacement parts!

SONNY'S® TOP BRUSH

DUAL COUNTER WEIGHT



1 15/16" 2-BOLT FLANGE BEARING
SONNY'S PARTS

\$66.66 UCFT21031



1 1/2" 2-BOLT FLANGE BEARING
SONNY'S PARTS

\$49.14 RY245



1 1/2" 4-BOLT FLANGE BEARING
SONNY'S PARTS

\$49.15 UCF20824



DIAPHRAGM CHECK VALVE
SONNY'S PARTS

• 1/4" MPT

\$5.78 SNQJ8360NYBLQR

3 NEEDED

4240N-B020 REPLACEMENT

SONNY'S® TOP BRUSH 2K14

BRUSH ARM - COMMON PARTS



1 1/2" - 2-BOLT FLANGE BEARING
SONNY'S PARTS

\$49.14 RY245



1 1/2" - 4-BOLT FLANGE BEARING
SONNY'S PARTS

\$49.15 UCF20824



DIAPHRAGM CHECK VALVE
SONNY'S PARTS

• 1/4" MPT

\$5.78 SNQJ8360NYBLQR

3 NEEDED

4240N-B020 REPLACEMENT

SONNY'S® TOP BRUSH 2K14 - CONTINUED

MOTOR DRIVE OPTIONS

HYDRAULIC

WINSMITH



TE SERIES 292 RPM PARKER HYDRAULIC TORQMOTOR™

SONNY'S PARTS

\$634.01 PM1255



1½ HP/1800RPM/56C - 230/460 STERLING MOTOR

SONNY'S PARTS

\$494.99 MSE3010

SONNY'S® FRONT-TO-BACK MITTER

SFM901 HALF-MOON BASKET



NO FLANGE TAPER LOCK BUSHING - 1½"

SONNY'S PARTS

\$34.22 TLB2012-112

SONNY'S® SF TOP MOTOR SIDE WASHERS

SF50, SF63, SF1

SF50 & SF63

SF1 SINGLE & DUAL



TE SERIES 292 RPM PARKER HYDRAULIC TORQMOTOR™

SONNY'S PARTS

\$634.01 PM1255



TE SERIES 582 RPM PARKER HYDRAULIC TORQMOTOR™

SONNY'S PARTS

\$467.43 PM1200

SONNY'S® SF BOTTOM MOTOR SIDE WASHERS

SFB18, SFB21, SFB28, SFB35, SFB50, SFB63, SFBTBG18

SFB35 & COMMON PARTS

TBG18 ROCKER PANEL WASHER



TE SERIES 292 RPM PARKER HYDRAULIC TORQMOTOR™

SONNY'S PARTS

\$634.01 PM1255



TE SERIES 887 RPM PARKER HYDRAULIC TORQMOTOR™

SONNY'S PARTS

\$545.53 PM1250

SONNY'S® SF50 FRONT GRILL BRUSH

LIGHT TOUCH GRILL BRUSH



TE SERIES 582 RPM PARKER HYDRAULIC TORQMOTOR™

SONNY'S PARTS

\$467.43 PM1200



90° ELBOW ¼" NPTM x ⅜" TUBE KQ2 ONE-TOUCH FITTINGS - PACK OF 10

SONNY'S PARTS

| PRICE | KR # | SMC # |
|----------------|----------|-------------|
| \$26.74 | FME-0406 | KQ2L11-35AS |



SEALED BRANCH TEE FITTINGS- ¼" NPTM x ⅜" TUBE KQ2 ONE-TOUCH FITTINGS - PACK OF 10

SONNY'S PARTS

| PRICE | KR # | SMC # |
|----------------|----------|-------------|
| \$39.15 | FMT-0406 | KQ2T11-35AS |



NOT INTENDED FOR POTABLE WATER SYSTEMS

CALIFORNIA PROPOSITION 65 NOTE: some items on this page may fall under the Proposition 65 act. Please consult the State of California Proposition 65 list (oehha.ca.gov/proposition-65/proposition-65-list) to learn more and to see a comprehensive list of Proposition 65 chemicals.

SONNY'S® WRAP-AROUND WASHERS

SF68 STRAIGHT ARMS & SF72 DOUBLE JOG ARMS

SF68 & SF72 WRAP-AROUND COMMON PARTS

HYDRAULIC DRIVE PARTS



TE SERIES 292 RPM PARKER HYDRAULIC TORQMOTOR™
SONNY'S PARTS

\$634.01 PM1255



90° ELBOW 1/4" NPTM x 3/8" TUBE
KQ2 ONE-TOUCH FITTINGS - PACK OF 10
SONNY'S PARTS

| PRICE | KR # | SMC # |
|----------------|----------|-------------|
| \$26.74 | FME-0406 | KQ2L11-35AS |



SONNY'S® OMNI WASH ARCHES

TOP, SIDE & WHEEL BLASTERS

SONNY'S® DOUBLE AND TRIPLE APPLICATORS

DRIP STYLE FOAMERS

HYDRAULIC OMNI BLASTER, SINGLE MANIFOLD

DOUBLE & TRIPLE DRIP



TE SERIES 582 RPM PARKER HYDRAULIC TORQMOTOR™
SONNY'S PARTS

\$467.43 PM1200



1 5/8" I.D. STAINLESS STEEL CUSH-A-CLAMP
SONNY'S PARTS

\$34.49 CLO26NS030



SONNY'S® TIRE DRESSING CONTROL PANEL

24V OR 110V



5GPM FLOJET AIR PUMP
1/2" VITON, QUICK CONNECT
SONNY'S PARTS

\$181.52 FP573145



FLOJET 1/2" POLYTUBE FITTING
SONNY'S PARTS

\$24.38 FPK08PT

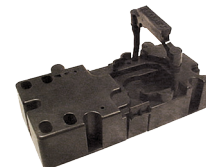

MOUNTING BRACKET
SONNY'S PARTS

\$15.82 FPK209821



SOLENOID VALVES

SONNY'S PLC



200 SERIES 3-WAY
1/4" NPTF MAC
POPPET VALVE
SONNY'S PARTS

| | | |
|----------------|---------|------|
| \$63.25 | MAC2090 | 24V |
| \$65.79 | MAC2060 | 120V |



1/4" - 4-WAY MAC VALVE
SONNY'S PARTS

| | | |
|----------------|---------|------|
| \$85.90 | MAC2230 | 24V |
| \$85.90 | MAC2160 | 120V |



SMC 1/4" NPT REGULATOR
0 - 145 PSI
SONNY'S PARTS

• TEMP.: 23° to 140°F (with no freezing)

| PRICE | PART # | MFG. PART # |
|----------------|--------|---------------|
| \$32.43 | SMC110 | AW20-N02E-Z-B |



SONNY'S® TIRE SEAL MACHINES

TIRE DRESSING ROTATIONAL BRUSH

TIRE SEAL HYDRAULIC



TE SERIES 887 RPM PARKER HYDRAULIC TORQMOTOR™
SONNY'S PARTS

\$545.53 PM1250



TC SERIES 688 RPM PARKER HYDRAULIC MOTOR
SONNY'S PARTS

\$412.26 PM1225

SONNY'S® AIR DRYING MACHINES

BLOWER PRODUCERS

BLOWER MOTORS 10HP, 15HP, AND MOTOR MOUNT



BALDOR RELIANCE WASHDOWN MOTOR
10 HP/3490 RPM/ 215TC
SONNY'S PARTS

\$2,809.10 MBCEWDM3711T



3 PHASE BALDOR MOTOR
10 HP/3490 RPM/ 215TC
SONNY'S PARTS

\$2,020.93 MBCEM3711T

CALIFORNIA PROPOSITION 65 NOTE: some items on this page may fall under the Proposition 65 act. Please consult the State of California Proposition 65 list (oehha.ca.gov/proposition-65/proposition-65-list) to learn more and to see a comprehensive list of Proposition 65 chemicals.

SONNY'S® BUFF-N-DRY TOP BRUSH

DUAL COUNTER WEIGHT



1½" 2 BOLT FLANGE BEARING
SONNY'S PARTS

\$49.14 RY245

FOR MORE REPLACEMENT BEARINGS
SEE THE BEGINNING OF THE
AUTOMATICS & TUNNELS SECTION!

SONNY'S® WIPE-O-MATIC

DRYING MACHINE

TIRE SHINE RETRACT ARM



24V - 1/4" - 4 WAY MAC VALVE
SONNY'S PARTS

\$85.90 MAC2230

PIVOTING AND CURTAIN TOP RETRACT ARMS



120VAC - 1/4" - 4 WAY MAC VALVE
SONNY'S PARTS

\$85.90 MAC2160

SONNY'S® HYDRAULIC POWER PACK PARTS

HYDRAULIC POWER PACK MOTORS



BALDOR 3HP MOTOR FOR POWER PACK
SONNY'S PARTS

\$981.36 MBEHPM3615T



BALDOR 5HP MOTOR FOR POWER PACK
SONNY'S PARTS

\$1,365.39 MBEHPM3710T

SONNY'S® ROLLER REPLACEMENT PARTS



IDLER WHEEL
SONNY'S PARTS

• 2¼" D x 2¼" L x 7/8" B **2 REQUIRED**

| | | |
|---------------|----------------|--------|
| \$4.73 | 21/4IW | Red |
| \$4.57 | 21/4IWY | Yellow |
| \$7.27 | 21/4IWB | Blue |



IDLER WHEEL
SONNY'S PARTS

• 2½" D x 2¾" L x 7/8" B **2 REQUIRED**

| | | |
|---------------|----------------|--------|
| \$6.28 | 23/4IW | Red |
| \$6.05 | 23/4IWY | Yellow |
| \$6.26 | 23/4IWB | Blue |



IDLER WHEEL
SONNY'S PARTS

• 2¼" D x 1½" L

\$1.73 21/4118IW

2 REQUIRED



½" x ¾" HEX BOLT
SONNY'S PARTS

\$0.31 13203



STEEL WASHERS
SONNY'S PARTS

| | | |
|---------------|----------------|------|
| \$0.13 | 0133012 | 1/2" |
| \$0.18 | 33094 | 7/8" |

2 REQUIRED

FOR SONNY'S® 4 WHEEL & 6 WHEEL ROLLERS



PUSHER WHEEL
SONNY'S PARTS

• 3" D x 3¾" L x 1" B

| | | |
|---------------|---------------|--------|
| \$9.46 | MPTP3 | Red |
| \$9.92 | MPTP3Y | Yellow |

FOR SONNY'S® LOW, TALL & MID PROFILE ROLLERS

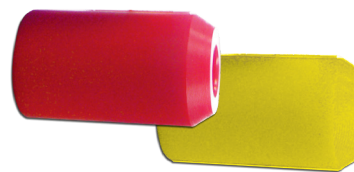

PUSHER WHEEL
SONNY'S PARTS

• 2¼" D x 4" L x 1" B

| | | |
|---------------|-----------------|--------|
| \$8.73 | MPTP214 | Red |
| \$9.92 | MPTP214Y | Yellow |

BELANGER® REPLACEMENT PARTS

DURATRANS

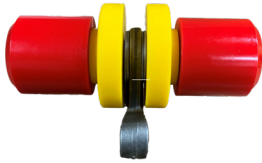

ROLLER ASSEMBLY BELANGER PARTS

• Polyurethane outriggers are durable and easy to replace. Attach with the appropriate chain links, sold separately.

\$93.30 BC126

CONVEYOR - DURATRANS XD®



PARKER TE SERIES HYDRAULIC MOTORS BELANGER PARTS

- Ideal for over-under conveyor
- Use with Sungear
- Please confirm length measurement to ensure motor is the correct size for your equip.
- Corrosion-resistant black paint
- 2 bolt mount

\$628.76 PM1245 7-5/16" **\$696.19** PM1230 6-13/16"



1 15/16" 2-BOLT FLANGE BEARING BELANGER PARTS

\$66.66 UCFT21031

CONVEYOR - DURATRANS XD® & TOP TRACK PRO



CHAIN SECTIONS BELANGER PARTS

• Sold in 10 ft. sections - Price is per 10 feet

\$102.10 PER 10 FT. X458



BAR BELANGER PARTS

\$4.75 X458BAR



PIN BELANGER PARTS

\$2.40 X458PIN



CENTER LINK BELANGER PARTS

\$3.85 X458LINK



SEALMASTER RFB200C HEAVY DUTY 4 BOLT FLANGE BELANGER PARTS

\$475.94 UCF10000

CONVEYOR - TOP TRACK PRO/DRYER PARTS

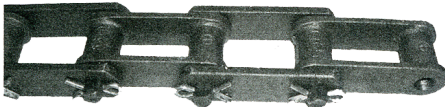

C188 (PITCH 2.609") BELANGER PARTS

- Sold in 10 ft. sections
- Chain Cottered
- Pin & Cotter
- Same Side Steel Cotters

\$77.50 PER 10 FT. C188-10

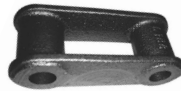

BLOCK LINK BELANGER PARTS

\$3.95 C188BLOCK



3/8-16" REPLACEMENT NUT BELANGER PARTS

\$0.15 AC1-NUT



7/8" RIGHT OR LEFT LINK BELANGER PARTS

\$4.58 TRIPL



C188 PIN & COTTER BELANGER PARTS

\$1.95 188P



BALDOR MOTORS BELANGER PARTS

- Pressure cast aluminum end plates with ribbed design for rigidity
- Ball bearings
- Locked drive end bearing
- Heavy gauge steel frame

| PRICE | PART # | HP | PHASE | RPM |
|-------------------|------------|----|-------|------|
| \$2,780.47 | MBCEM3713T | 15 | 3 | 3500 |
| \$2,020.93 | MBCEM3711T | 10 | 3 | 3490 |

FRONT-TO-BACK MITTER PARTS



BALDOR WASH DOWN MOTOR BELANGER PARTS

- Steel 230/460V wash down motor
- Max operating temp.: 104°F
- Sealed pulley end bearings
- Reversible shaft rotation

| PRICE | PART # | HP | PHASE | RPM |
|-------------------|------------|----|-------|------|
| \$1,395.02 | MBEWD3558T | 2 | 3 | 1800 |



ROD END BEARING 3/4" MALE BELANGER PARTS

\$25.14 VM12G



NO FLANGE TAPER LOCK BUSHING - 1 1/2" BELANGER PARTS

\$34.22 TLB2012-112

BELANGER® REPLACEMENT PARTS

SIDE & WRAP AROUND BRUSH PARTS

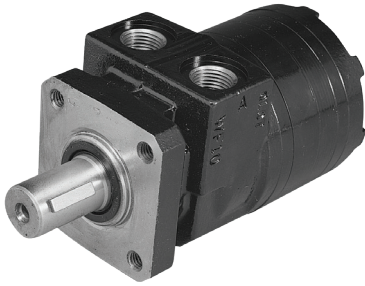

TB MOTORS

PARKER ROSS MOTORS

- Fully interchangeable with industry standards for porting, standard shafts & mountings
- Zero-leak commutation valve provides greater, more consistent, volumetric efficiency
- Full-flow lubrication maximizes cooling & extends motor life up to 50%
- Unique high-pressure shaft seal - eliminates need for case drains

| PRICE | PART # | PARKER NUMBER | DISPLACEMENT | RPM | SHAFT | PORTS | MOUNT |
|-----------------|---------------|----------------|--------------|-----|-------|-----------|--------|
| \$353.85 | PM1175 | TB0100FP100AAC | 6.0 cu"/rev | 454 | 1" | 1/2" NPTF | 4 Bolt |
| \$403.06 | PM1115 | TB0195FP100AAC | 11.9 cu"/rev | 287 | 1" | 1/2" NPTF | 4 Bolt |

HUBS/SWIVEL/TURBO ARMS



MOSMATIC
3/8" SWIVEL WITH
BULKHEAD FITTING
BELANGER PARTS

CALL SWM33163



MOSMATIC TURBO ARM
4-NOZZLE 20"/14"
BELANGER PARTS

CALL SWMTA86843



DEMA 202B 3/8"
INJECTOR
BELANGER PARTS

- Brass
- Rytan screw metering knob
- .73 - 5.7 GPM
- Max. Induction: 8 oz/min

\$59.78 IN202B



DEMA 204B 1/2"
ADJUSTABLE INJECTOR
BELANGER PARTS

- Brass
- Screw adjustable
- 5.7 - 19 GPM
- Max. Induction: 36 oz/min

\$64.88 IN204B



DEMA 206B 3/4"
ADJUSTABLE INJECTOR
BELANGER PARTS

- Brass
- Screw adjustable
- 11 - 39 GPM
- Max. Induction: 42 oz/min

\$81.26 IN206B



TIRE BRUSH REPLACEMENT



STAINLESS STEEL
TRIGGER GUN
BELANGER PARTS

- INLET: 1/4" FPT
- MAX PSI: 150

\$134.55 GUSS3604-SS Trigger Gun
\$12.77 GUSS3604K Repair Kit



1" ALUMINUM
COUPLERS
BELANGER PARTS

\$25.54 AC1



PARKER TB SERIES MOTOR
BELANGER PARTS

- Displacement: 3.0" 3/rev
- RPM: 678 • Shaft: 1"
- Ports: 1/2" NPTF • Mount: 4 Bolt

PRICE **PART #** **PARKER NUMBER**
\$348.25 **PM1150** TB0050FP100AAC



4 BOLT SPINDLE
BELANGER PARTS

- 4 1/2" long
- 1 1/4" shaft down to 1" with key

\$79.58 UBA42016



96" STANDARD
TIRE BRUSH
(NYLON/POLY MIX)
BELANGER PARTS

- Black
- Shaft: Bolt Adapter

\$920.97 UB504BK

VALVES/SOCK/OIL RESERVOIR



IN-LINE COMPOSITE
FLOW CONTROL VALVE
BELANGER PARTS

- MAX TEMP.: 200°F
- MAX PSI: 200

PRICE **PART #** **NPTF**
\$27.44 **104104-F02** 1/4"
\$37.99 **104104-F03** 3/8"



NORMALLY CLOSED 2-WAY
SOLENOID VALVE
BELANGER PARTS

- ORIFICE: 1/8" • FLOW FACTOR: .28
- WATTS: 10 (AC) • CONDUIT: 1/2"
- LEADS: 18" • Stainless Steel

\$120.53 **SOP1090** 110/50-120/60V
\$111.77 **SOP1050** 24/60V



1/4" MAC VALVE NPS
BELANGER PARTS

\$85.90 **MAC2160** 120V
\$85.90 **MAC2230** 24V
\$14.28 **MAC1001** 24V Replacement Coil
\$14.28 **MAC1002** 120V Replacement Coil



CONDUIT COIL
BELANGER PARTS

- 10 Watts (AC)
- 1/2" NPT conduit
- Class F

\$53.36 **SOPC500** 24V AC
\$53.37 **SOPC505** 110V



1/4" 3-WAY
SOLENOID
BELANGER PARTS

- 24 VAC
- 1/2" NPT Conduit
- Rotates 360° for easy installation

\$159.04 **SOP1135**

CALIFORNIA PROPOSITION 65 NOTE: some items on this page may fall under the Proposition 65 act. Please consult the State of California Proposition 65 list (oehha.ca.gov/proposition-65/proposition-65-list) to learn more and to see a comprehensive list of Proposition 65 chemicals.

BELANGER® REPLACEMENT PARTS

CHECK VALVES & NOZZLES



1/4" CHECK VALVE
BELANGER PARTS

• Max PSI: 125 • 1/4" NPT (M)

\$6.99 SN836014NYBL



VITON DIAPHRAGM
BELANGER PARTS

\$1.40 SNCP21953VI



1/4" FPT QUICK ADAPT CAP
BELANGER PARTS

\$0.86 HYPCAP0103



EPDM RUBBER WASHER GASKET FOR CAP 10-20 ADAPTER CAP
BELANGER PARTS

\$1.24 HYP221164



DIAPHRAGM CHECK VALVE
BELANGER PARTS

• 1/4" MPT

\$5.78 SNQJ8360NYBLQR

4240N-B020 REPLACEMENT



1/2" x 1/4" - SPLIT EYELET BODY
BELANGER PARTS

\$5.98 SE75210804



1/4" M TEEJET - BRASS BODY
BELANGER PARTS

\$2.22 SNCP1322



TEEJET STRAINER WITH CHECK VALVE
BELANGER PARTS

• Polypropylene - 50 mesh

\$3.11 SNTJ4193PP550



BRASS TEEJET TIP RETAINER
BELANGER PARTS

\$1.32 SNCP1325



BRASS UNIJET 25° SPRAY TIPS
BELANGER PARTS

| PRICE | PART # | ORIFICE |
|---------------|----------|---------|
| \$2.65 | SNTP2504 | .050 |
| \$2.65 | SNTP2505 | .056 |
| \$2.65 | SNTP2507 | .067 |



BRASS UNIJET 40° SPRAY TIP
BELANGER PARTS

| PRICE | PART # | ORIFICE |
|---------------|----------|---------|
| \$2.65 | SNTP4040 | .156 |



UNIJET CONE SPRAY TIPS
BELANGER PARTS

| PRICE | PART # | ORIFICE |
|---------------|----------|---------|
| \$3.99 | SNCJTX10 | .060 |
| \$3.99 | SNCJTX5 | .044 |

NOZZLE BUNDLES



GENERAL PUMP BELANGER VECTOR NOZZLE BUNDLE
KLEEN-RITE KITS

- FOR AUTOMATIC CAR WASH SYSTEMS
- (16) 915040M General 1504 Spray Tip 1/4"
- (4) 940060M General 4006 Spray Tip 1/4"
- (10) 925040M General 2504 Spray Tip 1/4"
- (2) 940040M General 4004 Spray Tip 1/4"

\$86.40 KRK5100

BELANGER® REPLACEMENT PARTS

VECTOR RAPID WASH™

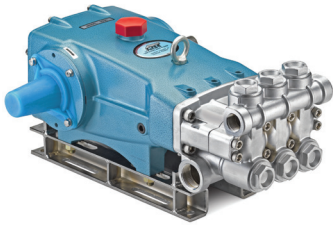

CAT PUMPS® 3535 SERIES CERAMIC PLUNGER PUMP BELANGER PARTS

- **FLOW:** 36 GPM
- **PRESSURE:** 100 - 1,200 PSI
- **RPM:** 800 RPM
- **HP:** 29.7

\$4,660.68 PU03535



CAT PUMPS® 3535 SERIES KITS & OIL BELANGER PARTS

| PART # | DESCRIPTION | KITS NEEDED |
|---------------|---------------|-------------|
| PU34235 | Valve Kit | x 2 |
| PU31040 | Seal Kit | x 1 |
| PU92674 | Pump Rails | - |
| Factory Sized | Pump Pulley | - |
| PU06100 | 21 oz. bottle | |
| PU06105 | 2.5 gallons | |



6018 ACCUMULATOR CAT PUMPS® PULSATION DAMPENER BELANGER PARTS

- **FLOW:** 40 GPM
- **TEMP:** Up to 180°F
- Rechargeable
- Replaces the 6010
- **PRESSURE:** 3000 PSI
- **PORT SIZE:** 1" NPTM

\$358.75 PU6018 HAZARDOUS MATERIAL



1/4" SPRAY TIPS BELANGER PARTS

| PRICE | PART # | TYPE |
|---------------|-----------|------|
| \$3.79 | GPN1504M4 | 1504 |
| \$3.79 | GPN4006M4 | 4006 |
| \$3.79 | GPN4004M4 | 4004 |
| \$3.79 | GPN2504M4 | 2504 |

ROLLER REPLACEMENT PARTS



IDLER WHEEL BELANGER PARTS

- 2 1/4" D x 2 1/4" L x 7/8" B **2 REQUIRED**

| | | |
|---------------|----------------|--------|
| \$4.73 | 21/4IW | Red |
| \$4.57 | 21/4IWY | Yellow |
| \$7.27 | 21/4IWB | Blue |

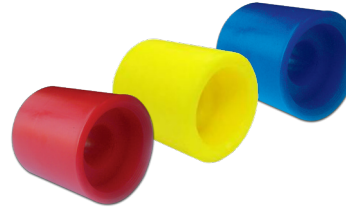

IDLER WHEEL BELANGER PARTS

- 2 1/2" D x 2 3/4" L x 7/8" B **2 REQUIRED**

| | | |
|---------------|----------------|--------|
| \$6.28 | 23/4IW | Red |
| \$6.05 | 23/4IWY | Yellow |
| \$6.26 | 23/4IWB | Blue |



IDLER WHEEL BELANGER PARTS

- 2 1/4" D x 1 1/8" L **2 REQUIRED**

\$1.73 21/4118IW



1/2" x 3/4" HEX BOLT BELANGER PARTS

\$0.31 13203



STEEL WASHERS BELANGER PARTS

\$0.18 33094 7/8"



REPLACEMENT ROLLER BELANGER REPLACEMENT PARTS

- Welded shaft

| | | | |
|----------------|-----------------|--------|------|
| \$54.55 | B6WL214 | 2 1/4" | Red |
| \$54.55 | B6WL214B | 2 1/4" | Blue |
| \$54.60 | B6WL234 | 2 3/4" | Red |
| \$54.60 | B6WL234B | 2 3/4" | Blue |
| \$57.89 | B6WL258 | 2 5/8" | Red |
| \$57.89 | B6WL258B | 2 5/8" | Blue |



PUSHER WHEEL BELANGER REPLACEMENT PARTS

- 2 1/4" D x 3 3/8" L x 1" Bore **4 REQUIRED**

| | | |
|---------------|----------------|------|
| \$9.94 | BTP318 | Red |
| \$9.92 | BTP318B | Blue |



PUSHER WHEEL BELANGER REPLACEMENT PARTS

- 2 1/4" D x 3 3/4" L x 1" Bore **4 REQUIRED**

| | | |
|----------------|----------------|------|
| \$10.53 | BTP334 | Red |
| \$9.92 | BTP334B | Blue |



IDLER WHEEL BELANGER REPLACEMENT PARTS

- 2 1/4" D x 2 5/8" L x 7/8" Bore **2 REQUIRED**

| | | |
|---------------|----------------|------|
| \$6.95 | 25/8IW | Red |
| \$6.78 | 25/8IWB | Blue |

BELANGER® REPLACEMENT PARTS

SIDE WASHER

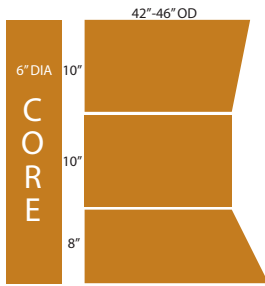

MODEL 2001 & 2x2 DRIVER SIDE 28" HIGH CORE FIVE STAR CAR WASH FOR BELANGER®

- 6" Diameter core
- 28 Channels x 28" high

CLOTH REPLACEMENT

- 28 pcs: 10" x 18"/16"
- 28 pcs: 10" x 16"
- 28 pcs: 8" x 16"/20"

| CLOTH | | |
|-----------------|-----------------|-------|
| PRICE | PART# | COLOR |
| \$534.39 | UBC100BL | Blue |
| \$534.39 | UBC100BK | Black |
| \$534.39 | UBC100R | Red |
| \$534.39 | UBC100G | Green |

| FOAM | | |
|-----------------|-----------------|-------|
| PRICE | PART# | COLOR |
| \$736.78 | UBF100BL | Blue |
| \$736.78 | UBF100BK | Black |
| \$736.78 | UBF100R | Red |
| \$736.78 | UBF100G | Green |

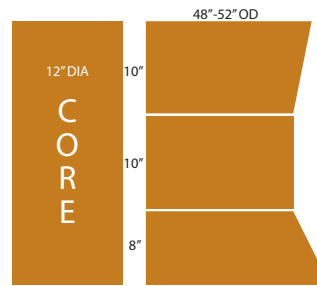

MODEL 2001 & 2x2 PASSENGER SIDE 28" HIGH CORE FIVE STAR CAR WASH FOR BELANGER®

- 12" Diameter core
- 44 Channels x 28" high

CLOTH REPLACEMENT

- 44 pcs: 10" x 18"/16"
- 44 pcs: 10" x 16"
- 44 pcs: 8" x 16"/20"

| CLOTH | | |
|-----------------|-----------------|-------|
| PRICE | PART# | COLOR |
| \$841.38 | UBC105BL | Blue |
| \$841.38 | UBC105BK | Black |
| \$841.38 | UBC105R | Red |
| \$841.38 | UBC105G | Green |

| FOAM | | |
|-------------------|-----------------|-------|
| PRICE | PART# | COLOR |
| \$1,150.65 | UBF105BL | Blue |
| \$1,150.65 | UBF105BK | Black |
| \$1,150.65 | UBF105R | Red |
| \$1,150.65 | UBF105G | Green |

MITTER

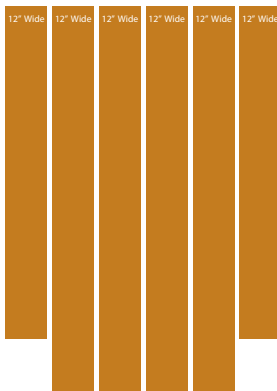

ROD STYLE

WHIPPER SNAPPER 4 BASKET CAR LENGTH CLOTH REPLACEMENT FOR BELANGER

CLOTH REPLACEMENT

- 16 pcs: 12" x 58" with 6" slit
- 16 pcs: 12" x 76" with 4" slit
- 16 pcs: 12" x 76" with 3" slit

| PRICE | PART# | COLOR |
|-----------------|------------------|-------|
| \$955.08 | UBCM153BL | Blue |
| \$955.08 | UBCM153BK | Black |
| \$955.08 | UBCM153R | Red |
| \$955.08 | UBCM153G | Green |

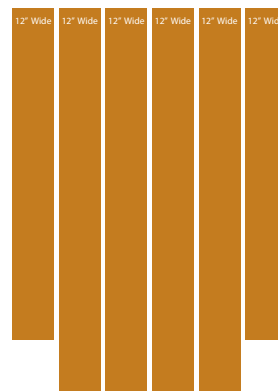

ROD STYLE

WHIPPER SNAPPER 4 BASKET VAN LENGTH CLOTH REPLACEMENT FOR BELANGER

CLOTH REPLACEMENT

- 16 pcs: 12" x 76" with 6" slit
- 16 pcs: 12" x 94" with 4" slit
- 16 pcs: 12" x 94" with 3" slit

| PRICE | PART# | COLOR |
|-------------------|------------------|-------|
| \$1,091.52 | UBCM113BL | Blue |
| \$1,091.52 | UBCM113BK | Black |
| \$1,091.52 | UBCM113R | Red |

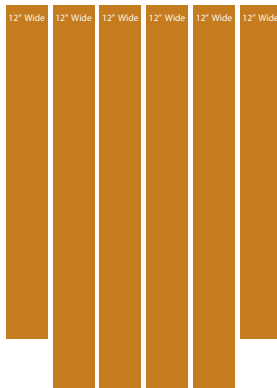

ROD STYLE

WHIPPER SNAPPER 6 BASKET VAN LENGTH CLOTH REPLACEMENT FOR BELANGER

CLOTH REPLACEMENT

- 24 pcs: 12" x 76" with 6" slit
- 24 pcs: 12" x 94" with 4" slit
- 24 pcs: 12" x 94" with 3" slit

| PRICE | PART# | COLOR |
|-------------------|------------------|-------|
| \$1,637.28 | UBCM103BL | Blue |
| \$1,637.28 | UBCM103BK | Black |
| \$1,637.28 | UBCM103R | Red |
| \$1,637.28 | UBCM103G | Green |

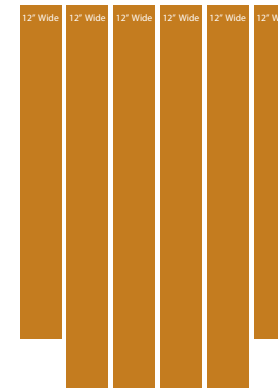

ROD STYLE

WHIPPER SNAPPER 6 BASKET CAR LENGTH CLOTH REPLACEMENT FOR BELANGER

CLOTH REPLACEMENT

- 24 pcs: 12" x 58" with 6" slit
- 24 pcs: 12" x 76" with 4" slit
- 24 pcs: 12" x 76" with 3" slit

| PRICE | PART# | COLOR |
|-------------------|------------------|-------|
| \$1,414.42 | UBCM143BL | Blue |
| \$1,414.42 | UBCM143BK | Black |
| \$1,414.42 | UBCM143G | Green |

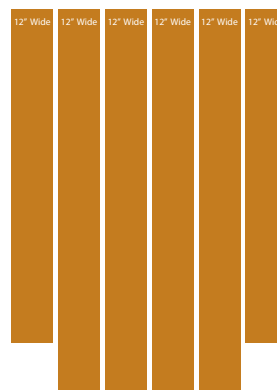

ROD STYLE

DOUBLE CROSS VAN LENGTH CLOTH REPLACEMENT FOR BELANGER

CLOTH REPLACEMENT

- 48 pcs: 12" x 78" with 3" slit

| PRICE | PART# | COLOR |
|-------------------|------------------|-------|
| \$1,009.66 | UBCM173BL | Blue |
| \$1,009.66 | UBCM173BK | Black |

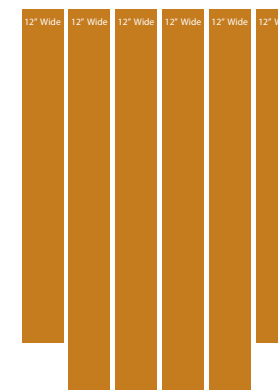

ROD STYLE

DOUBLE CROSS CAR LENGTH CLOTH REPLACEMENT FOR BELANGER

CLOTH REPLACEMENT

- 48 pcs: 12" x 60" with 3" slit

| PRICE | PART# | COLOR |
|-----------------|------------------|-------|
| \$850.48 | UBCM183BL | Blue |
| \$850.48 | UBCM183BK | Black |
| \$850.48 | UBCM183R | Red |
| \$850.48 | UBCM183G | Green |

MOTOR CITY WASH WORKS® CONVEYOR REPLACEMENT PARTS

CONVEYOR - SUPER DUTY™

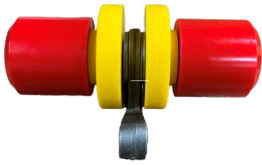

ROLLER ASSEMBLY

MOTOR CITY PARTS

• Polyurethane outriggers are durable and easy to replace. Attach with the appropriate chain links, sold separately.

\$93.30 BC126

CONVEYOR - SUPER DUTY™



PARKER TE SERIES HYDRAULIC MOTORS

MOTOR CITY PARTS

• 2 bolt mount

\$628.76 PM1245 7-5/16"

CONVEYOR - WASH STREET



PARKER TE SERIES HYDRAULIC MOTORS

MOTOR CITY PARTS

• 2 bolt mount

\$628.76 PM1245 7-5/16"
\$696.19 PM1230 6-13/16"

APPLICATORS



1 3/8" I.D. STAINLESS STEEL CUSH-A-CLAMP

MOTOR CITY PARTS

\$29.86 CLS22NS026



1 5/8" I.D. STAINLESS STEEL CUSH-A-CLAMP

MOTOR CITY PARTS

\$34.49 CLO26NS030



1/4" MPT DIAPHRAGM CHECK VALVE

MOTOR CITY PARTS

\$5.78 SNQJ8360NYBLQR

4240N-B020 REPLACEMENT



1/4" FPT QUICK ADAPT CAP

MOTOR CITY PARTS

\$0.86 HYPCAP0103



EPDM RUBBER WASHER GASKET FOR CAP10-20 ADAPTER CAP

MOTOR CITY PARTS

\$1.24 HYP221164



SPRAYING SYSTEMS

1/4" FPT INLET VITON TRIGGER JET

MOTOR CITY PARTS

\$18.99 GUSS50



SPRAYING SYSTEMS SPLIT EYELET WITH CHECK VALVE

MOTOR CITY PARTS

\$2.97 SNQJ17560-8BL 1/2"
\$2.98 SNQJ17560-12BL 3/4"

5" W x 32" L REGULAR FLOOR SWITCHES

TAPESWITCH



TECHNICAL DATA:

- **VOLTAGE:** 24 VAC or DC
- **MATERIAL:** Molded PVC
- **CURRENT RATING:** 1 Amp
- **COLOR:** Gray
- **ACTUATION FORCE:** 15 lbs nominal
- **MOUNTING:** 4 thru holes on 3/16" steel plate

| REGULAR FLOOR SWITCH | | | |
|----------------------|------------|-------|--------------|
| PRICE | PART # | CABLE | SIZE |
| \$131.76 | TSCW532 | 20 ft | 5" W x 32" L |
| \$151.50 | TSCW532-50 | 50 ft | 5" W x 32" L |

| RAMPED FLOOR SWITCH | | |
|---------------------|----------|--------------|
| PRICE | PART # | SIZE |
| \$181.78 | TSCW932R | 9" W x 32" L |



ASCO S SERIES 1/2" NORMALLY CLOSED SOLENOID VALVE

MOTOR CITY® PARTS

\$66.32 SC200 24V
\$66.32 SC225 120V



ASCO S SERIES 3/4" NORMALLY CLOSED SOLENOID VALVE

MOTOR CITY® PARTS

\$95.99 SC300 24V
\$95.99 SC325 120V



1/4" 120V 3-WAY MAC VALVE W/ DIN

MOTOR CITY® PARTS

\$47.27 MAC2020

CALIFORNIA PROPOSITION 65 NOTE: some items on this page may fall under the Proposition 65 act. Please consult the State of California Proposition 65 list (oehha.ca.gov/proposition-65/proposition-65-list) to learn more and to see a comprehensive list of Proposition 65 chemicals.

MOTOR CITY WASH WORKS® CONVEYOR REPLACEMENT PARTS

APPLICATORS - CONTINUED



511 HYDROMINDER - LOW VOLUME UNIT WITH SIPHON BEAKER (4.5 GPM)

MOTOR CITY PARTS

\$161.84 IN511



511 HYDROMINDER - LOW VOLUME UNIT WITH SINGLE E-GAP EDUCTOR (4.5 GPM)

MOTOR CITY PARTS

\$174.94 IN511ES



FLOJET G57 SERIES AIR-OPERATED PUMPS

MOTOR CITY PARTS

- MAX FLOW RATE: 5 GPM
- PRESSURE RATING: 20-100 PSI
- AIR CONSUMPTION: 2.1 SCFM at 100 PSI
- AIR INLET: 1/4" brass hose barb
- PRODUCT INLET: 1/2" PushLock
- PRODUCT OUTLET: 1/2" PushLock

| PRICE | PART # | DIAPHRAGM |
|-----------------|----------|------------|
| \$168.30 | FP575145 | SANTOPRENE |
| \$181.52 | FP573145 | VITON |
| \$237.03 | FP57142 | KALREZ |

California Proposition 65



FLOJET G57 SERIES AIR-OPERATED PUMPS

MOTOR CITY PARTS

- MAX FLOW RATE: 5 GPM
- PRESSURE RATING: 20-100 PSI
- AIR INLET: 1/4" brass hose barb
- PRODUCT INLET: 1/2" hose barb
- PRODUCT OUTLET: 1/2" hose barb

| PRICE | PART # | DIAPHRAGM | PORT KIT |
|-----------------|--------|------------|----------|
| \$102.17 | FP7040 | SANTOPRENE | FPK06B |
| \$142.99 | FP7020 | VITON | FPK06V |

California Proposition 65

BEARINGS & BRUSHES



1" 2-BOLT FLANGE BEARING

MOTOR CITY PARTS

\$27.55 UCFT20516

CHEMICAL SUPPLIES, METERING TIPS, HYDROMINDER PARTS



CLEAR VINYL TUBE

1/4" ID x 3/8" OD
MOTOR CITY PARTS

\$0.25 HCV04T



THREADED METERING TIP KIT

MOTOR CITY PARTS

\$12.00 IN690015



PUSH IN METERING TIP KIT

MOTOR CITY PARTS

\$12.41 IN690014



3401-R 1/4" TIP ADAPTER

MOTOR CITY PARTS

\$0.79 IN3401R



GRAY EPDM FOOT VALVE

MOTOR CITY PARTS

\$9.25 IN250100



BLUE VITON FOOT VALVE

MOTOR CITY PARTS

\$12.62 IN250020



1 1/2 - 9 GPM MAGNET KIT

MOTOR CITY PARTS

\$22.30 IN10080500



6655-K VALVE KIT/LOW-MED VOL.

MOTOR CITY PARTS

\$22.01 IN6655K



511 HYDROMINDER - LOW VOLUME UNIT WITH SIPHON BEAKER (4.5 GPM)

MOTOR CITY PARTS

\$161.84 IN511



511 HYDROMINDER - LOW VOLUME UNIT WITH SINGLE E-GAP EDUCTOR (4.5 GPM)

MOTOR CITY PARTS

\$174.94 IN511ES



572 HYDROMINDER WATER FLOAT VALVE ONLY WITH MOUNTING BRACKET (44 GPM)

MOTOR CITY PARTS

\$230.91 IN572

CALIFORNIA PROPOSITION 65 NOTE: some items on this page may fall under the Proposition 65 act. Please consult the State of California Proposition 65 list (oehha.ca.gov/proposition-65/proposition-65-list) to learn more and to see a comprehensive list of Proposition 65 chemicals.

MOTOR CITY WASH WORKS® CONVEYOR REPLACEMENT PARTS

NOZZLES



SPRAYING SYSTEMS CO.® WASHJET® IMEG® SPRAY NOZZLES
MOTOR CITY PARTS

- Spray angles of 0° to 65° - operating pressures from 300 PSI - 4000 PSI
- Longer wear life and flow control accuracy with specially hardened stainless steel

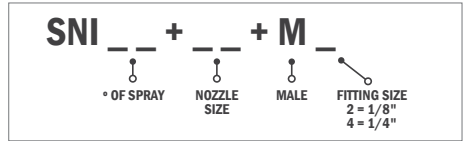

| 1/8" MPT MEG NOZZLES 25° | | | |
|--------------------------|----------|---------------|---------------|
| PRICE | PART # | DESCRIPTION | GPM @ 1000PSI |
| \$4.17 | SN2505M2 | SA1/8MEG-2505 | 2.5 |
| \$4.17 | SN2506M2 | SA1/8MEG-2506 | 3.0 |
| \$4.17 | SN2507M2 | SA1/8MEG-2507 | 3.5 |
| \$4.17 | SN2508M2 | SA1/8MEG-2508 | 4.0 |

| 1/8" MPT MEG NOZZLES 65° | | | |
|--------------------------|----------|---------------|---------------|
| PRICE | PART # | DESCRIPTION | GPM @ 1000PSI |
| \$4.17 | SN6505M2 | SA1/8MEG-6505 | 2.5 |
| \$4.17 | SN6506M2 | SA1/8MEG-6506 | 3.0 |
| \$4.17 | SN6507M2 | SA1/8MEG-6507 | 3.5 |
| \$4.17 | SN6508M2 | SA1/8MEG-6508 | 4.0 |

| 1/4" MPT MEG NOZZLES 5° | | | |
|-------------------------|----------|---------------|---------------|
| PRICE | PART # | DESCRIPTION | GPM @ 1000PSI |
| \$4.37 | SN0502M4 | SA1/4MEG-0502 | 1.0 |
| \$4.37 | SN0503M4 | SA1/4MEG-0503 | 1.5 |
| \$4.37 | SN0504M4 | SA1/4MEG-0504 | 2.0 |
| \$4.37 | SN0506M4 | SA1/4MEG-0506 | 3.0 |
| \$4.37 | SN0507M4 | SA1/4MEG-0507 | 3.5 |
| \$4.37 | SN0509M4 | SA1/4MEG-0509 | 4.5 |
| \$4.37 | SN0512M4 | SA1/4MEG-0512 | 6.0 |
| \$4.37 | SN0515M4 | SA1/4MEG-0515 | 7.5 |

| 1/4" MPT MEG NOZZLES 15° | | | |
|--------------------------|-----------|----------------|---------------|
| PRICE | PART # | DESCRIPTION | GPM @ 1000PSI |
| \$4.37 | SN1504M4 | SA1/4MEG-1504 | 2.0 |
| \$4.37 | SN15045M4 | SA1/4MEG-15045 | 2.25 |
| \$4.37 | SN1505M4 | SA1/4MEG-1505 | 2.5 |
| \$4.37 | SN15055M4 | SA1/4MEG-15055 | 2.75 |
| \$4.37 | SN15065M4 | SA1/4MEG-15065 | 3.25 |
| \$4.37 | SN1512M4 | SA1/4MEG-1512 | 6.0 |
| \$4.37 | SN1520M4 | SA1/4MEG-1520 | 10.0 |

| 1/4" MPT MEG NOZZLES 25° | | | |
|--------------------------|----------|---------------|---------------|
| PRICE | PART # | DESCRIPTION | GPM @ 1000PSI |
| \$4.37 | SN2502M4 | SA1/4MEG-2502 | 1.0 |
| \$4.37 | SN2505M4 | SA1/4MEG-2505 | 2.5 |
| \$4.37 | SN2506M4 | SA1/4MEG-2506 | 3.0 |
| \$4.37 | SN2507M4 | SA1/4MEG-2507 | 3.5 |
| \$4.37 | SN2508M4 | SA1/4MEG-2508 | 4.0 |
| \$4.37 | SN2510M4 | SA1/4MEG-2510 | 5.0 |

| 1/4" MPT MEG NOZZLES 40° | | | |
|--------------------------|----------|---------------|---------------|
| PRICE | PART # | DESCRIPTION | GPM @ 1000PSI |
| \$4.37 | SN4004M4 | SA1/4MEG-4004 | 2.0 |
| \$4.37 | SN4005M4 | SA1/4MEG-4005 | 2.5 |

| 1/4" MPT MEG NOZZLES 50° | | | |
|--------------------------|----------|---------------|---------------|
| PRICE | PART # | DESCRIPTION | GPM @ 1000PSI |
| \$4.37 | SN5003M4 | SA1/4MEG-5003 | 1.5 |
| \$4.37 | SN5004M4 | SA1/4MEG-5004 | 2.0 |
| \$4.37 | SN5006M4 | SA1/4MEG-5006 | 3.0 |
| \$4.37 | SN5010M4 | SA1/4MEG-5010 | 5.0 |

| 1/4" MPT MEG NOZZLES 65° | | | |
|--------------------------|----------|---------------|---------------|
| PRICE | PART # | DESCRIPTION | GPM @ 1000PSI |
| \$4.37 | SN6502M4 | SA1/4MEG-6502 | 1.0 |
| \$4.37 | SN6503M4 | SA1/4MEG-6503 | 1.5 |
| \$4.37 | SN6504M4 | SA1/4MEG-6504 | 2.0 |
| \$4.37 | SN6505M4 | SA1/4MEG-6505 | 2.5 |
| \$4.37 | SN6506M4 | SA1/4MEG-6506 | 3.0 |
| \$4.37 | SN6507M4 | SA1/4MEG-6507 | 3.5 |
| \$4.37 | SN6508M4 | SA1/4MEG-6508 | 4.0 |
| \$4.37 | SN6510M4 | SA1/4MEG-6510 | 5.0 |
| \$4.37 | SN6515M4 | SA1/4MEG-6515 | 7.5 |
| \$4.37 | SN6520M4 | SA1/4MEG-6520 | 10 |

| 1/4" MPT MEG NOZZLES WITH VANE | | | |
|--------------------------------|-----------|------------------|---------------|
| PRICE | PART # | DESCRIPTION | GPM @ 1000PSI |
| CALL | SNV6530M4 | MPT 6530 W/ VANE | 15.0 |



1/4K-15 PVC FLOODJET NOZZLE
MOTOR CITY PARTS

\$16.09 SNFJ04K15PVC



1/4" FPT QUICK ADAPT CAP
MOTOR CITY PARTS

\$0.86 HYPCAP0103



EPDM RUBBER WASHER GASKET FOR CAP10-20 ADAPTER CAP
MOTOR CITY PARTS

\$1.24 HYP221164



1/4" M DIAPHRAGM CHECK VALVE
MOTOR CITY PARTS

\$5.78 SNQJ8360NYBLQR
4240N-B020 REPLACEMENT



SPRAYING SYSTEMS SPLIT EYELET WITH CHECK VALVE
MOTOR CITY PARTS

\$2.97 SNQJ17560-8BL 1/2"
\$2.98 SNQJ17560-12BL 3/4"



SUTTNER ST-357 TURBO NOZZLES
MOTOR CITY PARTS

- 3600 PSI
- Colored seat indicates orifice size

| PRICE | ITEM # | ORIFICE |
|---------|-----------|--------------|
| \$59.93 | SUT357-3 | 3.0 - Yellow |
| \$59.93 | SUT357-6 | 6.0 - Red |
| \$33.96 | SUT357-3K | Repair Kit |

VALVES/PUMPS



ASCO S SERIES 1/2" NORMALLY CLOSED SOLENOID VALVE
MOTOR CITY PARTS

\$66.32 SC200 24V
\$66.32 SC225 120V



ASCO S SERIES 3/4" NORMALLY CLOSED SOLENOID VALVE
MOTOR CITY PARTS

\$95.99 SC300 24V
\$95.99 SC325 120V



1/4" MAC VALVE NPS
MOTOR CITY PARTS

\$85.90 MAC2160 120V
\$85.90 MAC2230 24V



200 SERIES 3-WAY 1/4" NPTF MAC POPPET VALVE
SONNY'S PARTS

\$63.25 MAC2090 24V
\$65.79 MAC2060 120V

MOTOR CITY WASH WORKS® CONVEYOR REPLACEMENT PARTS

VALVES/PUMPS



BLUE-WHITE® C-1500 SERIES - INJECTION METERING PUMPS

MOTOR CITY PARTS

- FKM O-ring & PTFE/EP diaphragm
- PVDF suction (foot) valve with FKM and TFE/P O-rings, ceramic check ball and removable polypropylene filter screen

SPECIFICATIONS

- STROKE: .055" • MAX FLOW: 26.6 GPD • VOLTAGE: 115 • MAX PRESSURE: 125 PSI • MAX TEMP: 130°F • RPM: 45

| | | | | | |
|----------|---------------|----------------|----------|---------------|-----------------|
| \$356.54 | BW15N202X | 115V 2.4oz/min | \$359.39 | BW15N341X | 115V 6.4oz/min |
| \$356.54 | BW15N331X | 24V 6.4oz/min | \$356.54 | BW15N432X066V | 24V 3.0oz/min |
| \$356.54 | BW15N301X066V | 115V 3.1oz/min | \$356.54 | BW15N404X | 115V 10.6oz/min |
| \$356.54 | BW15N302X066 | 115V 1.4oz/min | \$356.54 | BW15N432X24V | 24V 5.9oz/min |
| \$356.54 | BW15N332X | 24V 2.7oz/min | \$356.54 | BW15N402X | 115V 5.9oz/min |
| \$356.54 | BW15N302X | 115V 2.7oz/min | \$356.54 | BW15N414X040 | 220V 4.8oz/min |

CYLINDER, SHOCK, PUMPS



14 GPM 500:1-50:1 85 PSI DOSATRON CHEMICAL PROPORTIONER

MOTOR CITY PARTS

- The water-powered with Viton seal and O-rings, polypropylene housings and an easy-to-adjust ratio stem

\$444.04 D0SD1402



FLOJET G57 SERIES AIR-OPERATED PUMPS

MOTOR CITY PARTS

- MAX FLOW RATE: 5 GPM
- PRESSURE RATING: 20-100 PSI
- AIR INLET: 1/4" brass hose barb
- PRODUCT INLET: 1/2" hose barb
- PRODUCT OUTLET: 1/2" hose barb

| PRICE | PART # | DIAPHRAGM | PORT KIT |
|----------|--------|------------|----------|
| \$102.17 | FP7040 | SANTOPRENE | FPK06B |
| \$142.99 | FP7020 | VITON | FPK06V |



FLOJET VITON PUSH-IN POLYTUBE FITTING

MOTOR CITY PARTS

| | | |
|---------|---------|------|
| \$14.88 | FPK06PT | 3/8" |
| \$24.38 | FPK08PT | 1/2" |

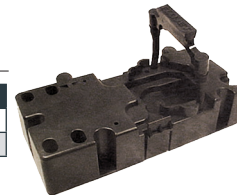

MOUNTING BRACKET

MOTOR CITY PARTS

\$15.82 FPK209821



PUMPS



D10-X HYDRA-CELL PUMP

MOTOR CITY PARTS

- MAX FLOW: 8.1 GPM
- MAX PSI: 1000
- MAX TEMP: 250°F
- MAX RPM: 1450
- INLET: 1" NPT
- OUTLET: 3/4" NPT
- WEIGHT: 48 lbs.
- SHAFT DIAMETER: 1/8"
- SHAFT ROTATION: Bi-directional

| | | |
|------------|--------------|-----------------|
| \$1,370.85 | D10XKBTHFECA | Pump |
| \$205.57 | WPA031751101 | D/G-10 Tool Kit |

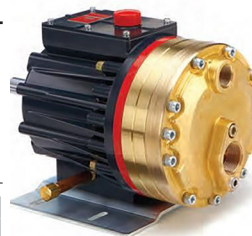

H-25-X HYDRA-CELL PUMP

MOTOR CITY PARTS

- MAX FLOW: 20 GPM
- MAX PSI: 1000
- MAX TEMP: 250°F
- MAX RPM: 1050
- INLET: 1 1/2"
- OUTLET: 1" NPT
- SHAFT DIAMETER: 1 1/8"

| | | |
|------------|--------------|------------------------|
| \$3,274.14 | WPH25XKBTH | Pump |
| \$17.66 | WPD030391030 | Oil Fill Cap W/ O-Ring |
| \$86.80 | WPD25D52TX | H25 Diaphragm |
| \$306.88 | D25K52THFEC | H25 Repair Kit |
| 346 | WPA031751102 | H/G-25 Fluid End |
| \$677.83 | WPA031751107 | Master Tool Kit |



D35-X HYDRA-CELL PUMP

MOTOR CITY PARTS

- MAX FLOW: 37 GPM
- MAX PSI: 250
- MAX TEMP: 250°F
- MAX RPM: 1050
- INLET: 2 1/2"
- OUTLET: 1 1/4" NPT
- SHAFT DIAMETER: 2"

| | | |
|------------|------------|------|
| \$5,866.19 | WPD35XKBTH | Pump |
|------------|------------|------|

| | | |
|----------|--------------|----------------------|
| 154 | WPA011163400 | 12 oz. Oil Reservoir |
| \$145.01 | D35D52TXXXX | Diaphragm Kit |
| \$243.07 | WPA032001100 | D/G-35 Tool Kit |
| \$677.83 | WPA031751107 | Master Tool Kit |



10W30 HYDRA-CELL OIL

MOTOR CITY PARTS

- Ideal for low temperature and high load
- Maintains consistent viscosity through a wide range of temperatures

| | | |
|---------|---------------|-----------|
| \$11.91 | WPOA011143430 | 1 Quart |
| \$81.98 | WPOA011143432 | 2 1/2 Gal |

CALIFORNIA PROPOSITION 65 NOTE: some items on this page may fall under the Proposition 65 act. Please consult the State of California Proposition 65 list (oehha.ca.gov/proposition-65/proposition-65-list) to learn more and to see a comprehensive list of Proposition 65 chemicals.

MOTOR CITY WASH WORKS® CONVEYOR REPLACEMENT PARTS

HYDRAULIC MOTORS/SELFIT HYDRAULIC HOSE KIT

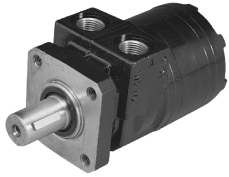

PARKER TB SERIES MOTORS
MOTOR CITY PARTS

- 1/2" NPTF Ports
- 4 bolt mount
- 1" Shaft

| PRICE | PART # | PARKER NUMBER | DISPLACEMENT | RPM |
|-----------------|---------------|-----------------|--------------|-----|
| \$403.06 | PM1115 | TB0195FP100AAAC | 11.9 cu"/rev | 287 |
| \$348.25 | PM1150 | TB0050FP100AAAC | 3.0 cu"/rev | 678 |
| \$349.45 | PM1155 | TB0065FP100AAAC | 4.0 cu"/rev | 511 |
| \$353.85 | PM1175 | TB0100FP100AAAC | 6.0 cu"/rev | 454 |
| \$277.21 | PM1185 | TB0165FP100AAAC | 9.9 cu"/rev | 343 |
| \$414.71 | PM1195 | TB0230FP100AAAC | 13.9 cu"/rev | 246 |



PARKER TE SERIES MOTORS
MOTOR CITY PARTS

- 7/8"-14 SAE Ports
- 4 bolt w/ 3/8-16 UNC
- 1" Shaft

| PRICE | PART # | PARKER NUMBER | DISPLACEMENT | RPM |
|-----------------|---------------|-----------------|--------------|-----|
| \$467.43 | PM1200 | TE0100FS100AAAC | 6.0 cu"/rev | 582 |
| \$545.53 | PM1250 | TE0065FS100AAAC | 4.0 cu"/rev | 877 |
| \$634.01 | PM1255 | TE0195FS100AAAC | 11.9 cu"/rev | 292 |



PARKER BUNA SEAL KIT
MOTOR CITY PARTS

- For TB/TC/TE series

| | |
|----------------|----------------|
| \$91.10 | SOPK320 |
|----------------|----------------|

ELECTRIC MOTORS & FITTINGS



1.5HP/1800RPM/56C - 230/460
STERLING MOTOR
MOTOR CITY PARTS

| | |
|-----------------|----------------|
| \$494.99 | MSE3010 |
|-----------------|----------------|



3 PHASE BALDOR MOTOR
10 HP/3490 RPM/ 215TC
MOTOR CITY PARTS

| | |
|-------------------|-------------------|
| \$2,020.93 | MBCEM3711T |
|-------------------|-------------------|

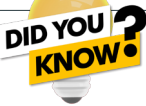

Motor City Wash Works, Inc. was founded in 2004 and has grown to become a respected leader in the car wash industry. This reliable car wash company focuses on tunnel wash systems and other automatic equipment. They offer quality systems in a variety of sizes to fit different customers' applications. They also offer fleet systems for auto dealerships, vehicle rental agencies, and truck fleets. Regardless of your type of wash, Motor City will customize your system for things like performance needs, location size, and branding. Motor City Wash Works is fixated on setting the industry standard for innovation, durability, and performance.

Kleen-Rite carries an ample selection of new parts that are designed for use with Motor City Wash Works equipment. We can be your supplier for smaller parts like valves, nozzles, and rollers, as well as larger components like pumps and motors that are compatible with Motor City car wash systems. As with all of Kleen-Rite's products, you'll be sure to find the Motor City Wash Works parts you need at the most competitive prices on the market.

If you're a new owner of a Motor City Wash Works car wash system, it's crucial to select a parts supplier that you can trust to help service and maintain your equipment. Why not start off on the right foot and go with Kleen-Rite right away? If you've had a Motor City Wash Works system for years and are starting to realize that you're paying too much for your replacement parts, make the switch to Kleen-Rite and get yourself on the right track.

Browse our full listing of Motor City Wash Works replacement parts at kleen-ritecorp.com. You can also contact our sales team to discuss your needs and get advice on the parts you're going to need to keep your Motor City Wash Works system running at peak performance!

UNITEC WASH SELECT II REPLACEMENT PARTS



KEYPAD ASSEMBLY
ASTROMATIC

- FOR USE WITH: UNITEC Wash Select II

| | |
|----------------|---------------|
| \$72.34 | SA1833 |
|----------------|---------------|



PUSH BUTTON
ASTROMATIC

- FOR USE WITH: UNITEC Wash Select II

| | |
|---------------|---------------|
| \$8.24 | SA2167 |
|---------------|---------------|

HANNA™ REPLACEMENT PRODUCTS

DRIVE SPROCKETS



12 TOOTH SPROCKET
HANNA PARTS

\$122.99 SPROCKET12



2 1/4" TAPERED LOCK BUSHINGS
HANNA PARTS

\$41.64 TLB2517-214

DRUM & TAKE-UP SPROCKETS



AMI BEARING 4-BOLT FLANGE
1 15/16"
HANNA PARTS

\$66.66 UCF21031

CONVEYOR CHAINS



D88K RIVETED CHAINS - 2.609" PITCH
HANNA PARTS

| | | |
|----------------|---------|------------------|
| \$40.99 | D88K-16 | 16 Pitch Section |
| \$86.90 | D88K-34 | 34 Pitch Section |



D88K PIN & COTTER - 2.609" PITCH
HANNA PARTS

| | | |
|-----------------|-----------|------------------|
| \$35.33 | D88KPC-16 | 16 Pitch Section |
| \$149.99 | D88KPC-34 | 34 Pitch Section |

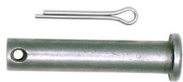

D88K 2 3/16" PIN & COTTER
HANNA PARTS

\$2.65 D88KDP



D88K 2 7/16" PIN & COTTER
HANNA PARTS

\$3.65 D88KDPL



STAINLESS STEEL COTTER ONLY
HANNA PARTS

\$0.30 D88KS-S



SC78 & SC78PC (PITCH 2.609")
HANNA PARTS

| | | |
|----------------|-----------|---------------------------------------|
| \$37.69 | SC78-16 | Riveted Chain (16 Pitch Section) |
| \$39.15 | SC78PC-16 | Pin & Cotter Chain (16 Pitch Section) |



SC78 PIN & COTTER
HANNA PARTS

\$2.75 SC78P



STAINLESS STEEL COTTER ONLY
HANNA PARTS

\$0.30 D88KS-S

HYDRAULIC MOTOR & GEAR BOX



2000 SERIES CHAR-LYNN® MOTORS
HANNA PARTS

| PRICE | PART# | DESCRIPTION |
|-----------------|----------------|--------------|
| \$617.13 | CL106-1012-006 | 11.9 cu"/Rev |
| \$638.14 | CL106-1013-006 | 14.9 cu"/Rev |
| \$656.86 | CL106-1014-006 | 18.7 cu"/Rev |

BUNA SEAL KIT FOR 2000 SERIES CHAR-LYNN® MOTORS
HANNA PARTS

\$46.52 CLP61259

SURFACE CONVEYOR REPLACEMENT PARTS



LOG CHAIN (3 1/2" PITCH)
HANNA PARTS

• Heat treated

\$8.75 LOGCH



LIMIT SWITCH, SQUARE-D 4-POSITION
HANNA PARTS

\$232.66 ST0310



LIMIT SWITCH, HEAD ROTARY FOR C54B2
HANNA PARTS

\$57.15 ST0311



LIMIT SWITCH, LEVER ARM ROD FOR C54B2
HANNA PARTS

\$38.86 ST0312

CONVEYOR PARTS



1" - 2 BOLT PILLOW BLOCK WITH SET SCREW LOCK
HANNA PARTS

\$29.03 UCP20516

CONVEYOR & CYLINDER DOORS



ARO CLEVIS MOUNT CYLINDER
1 1/2" BORE x 4 1/2" STROKE
HANNA PARTS

\$147.75 AC1060

HANNA™ REPLACEMENT PRODUCTS

ROLLERS

RCV STYLE

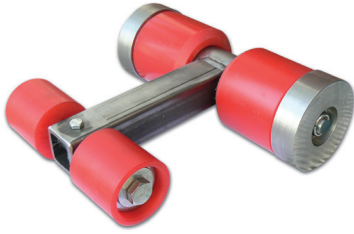

KLEEN-RITE REPLACEMENT ROLLER FOR HANNA STYLE RCV ROLLER

HANNA PARTS

- Bolted Shaft
- 1" W x 3½" D steel wheel
- CHAIN ATTACHMENT SOLD SEPARATELY

| PRICE | PART # | IDLER WHEEL |
|----------------|---------|-------------|
| \$98.90 | RCVR214 | 2¼" Wide |
| \$95.05 | RCVR234 | 2¾" Wide |



PUSHER WHEEL

HANNA PARTS

- 2 Required
- 3" x 3¼"

| | | |
|---------------|--------|--------|
| \$8.47 | RCVTP | Red |
| \$9.84 | RCVTPY | Yellow |



5/8" I.D. BUSHING

HANNA PARTS

| | |
|-----------------|------|
| \$4.00 | RCVB |
| 2 NEEDED | |

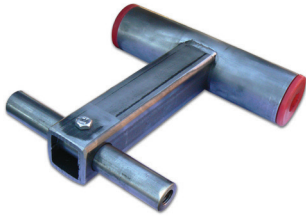

FRAME

HANNA PARTS

- Bushings NOT INCLUDED

| | |
|-------------|----------|
| CALL | RCVFRAME |
|-------------|----------|



REAR AXLE CROSS

HANNA PARTS

- 7/8"

| | |
|---------------|-------|
| \$9.88 | RCVRA |
|---------------|-------|



FRONT SHAFT

HANNA PARTS

- 5/8" D x 9¾" L

| | |
|-----------------|-------|
| \$11.00 | RCVFS |
| 1 NEEDED | |

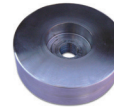

STEEL WHEEL REPLACEMENT PARTS

- 1" x 3½" Diameter

| | |
|-----------------|-------|
| \$21.30 | RCVSW |
| 2 NEEDED | |

6 WHEEL LOW PROFILE STYLE



6 WHEEL LOW PROFILE ROLLER

HANNA PARTS

- Chain attachment sold separately

| PRICE | PART # | IDLER WHEEL | COLOR |
|----------------|-----------|-------------|--------|
| \$56.48 | 6WLPR214 | 2¼" W | Red |
| \$44.50 | 6WLPR214Y | 2¼" W | Yellow |
| \$59.83 | 6WLPR234 | 2¾" W | Red |
| \$46.75 | 6WLPR234Y | 2¾" W | Yellow |

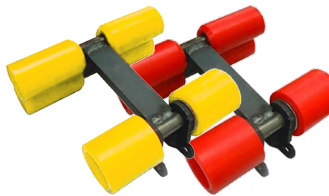

6 WHEEL LOW PROFILE ROLLER WITH M2 LINK

HANNA REPLACEMENT PARTS

- Chain attachment sold separately

| PRICE | PART # | IDLER WHEEL | COLOR |
|----------------|--------------|-------------|--------|
| \$56.55 | 6WLPR214-M2 | 2¼" W | Red |
| \$56.55 | 6WLPR214Y-M2 | 2¼" W | Yellow |
| \$71.53 | 6WLPR234-M2 | 2¾" W | Red |
| \$57.65 | 6WLPR234Y-M2 | 2¾" W | Yellow |

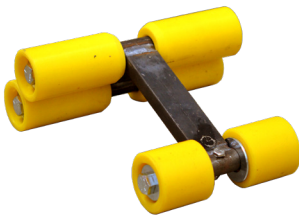

6 WHEEL LOW PROFILE ROLLER BOLTED SHAFT

HANNA PARTS

- Chain attachment sold separately

| PRICE | PART # | IDLER WHEEL | COLOR |
|----------------|-------------|-------------|--------|
| \$44.75 | 6WLPR214Y-B | 2¼" W | Yellow |
| \$46.99 | 6WLPR234Y-B | 2¾" W | Yellow |



LOW PROFILE FRAME

HANNA PARTS

| | |
|-----------------|--------|
| \$34.89 | 6WRLPF |
| 1 NEEDED | |

6 WHEEL HIGH PROFILE STYLE

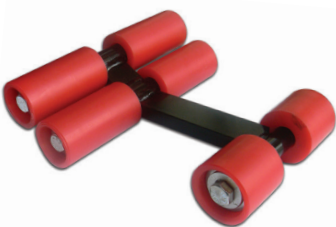

6 WHEEL HIGH PROFILE ROLLER

HANNA PARTS

- Chain attachment sold separately

| PRICE | PART # | IDLER WHEEL | COLOR |
|----------------|----------|-------------|-------|
| \$51.77 | 6WHPR214 | 2¼" W | Red |
| \$54.94 | 6WHPR234 | 2¾" W | Red |

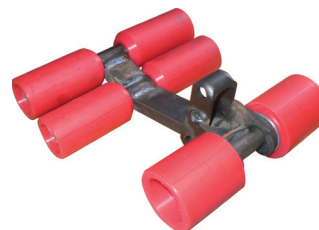

6 WHEEL HIGH PROFILE ROLLER WITH M2 LINK

HANNA PARTS

- Chain attachment sold separately

| PRICE | PART # | IDLER WHEEL | COLOR |
|----------------|-------------|-------------|-------|
| \$51.77 | 6WHPR214-M2 | 2¼" W | Red |
| \$54.94 | 6WHPR234-M2 | 2¾" W | Red |



HIGH PROFILE FRAME

HANNA PARTS

| | |
|-----------------|--------|
| \$46.25 | 6WRHPF |
| 1 NEEDED | |

PUSHER WHEELS FOR LOW & HIGH PROFILE



PUSHER WHEEL

HANNA REPLACEMENT PARTS

- 2" D x 4" L x 1" ID

| | | |
|---------------|------|--------|
| \$5.49 | 6WP | Red |
| \$4.93 | 6WPY | Yellow |

4 NEEDED

HANNA™ REPLACEMENT PRODUCTS

ROLLER REPLACEMENTS PARTS



D88K LINKS
HANNA PARTS

| | | |
|---------------|----------------|-------|
| \$9.93 | D88KALL | Left |
| \$9.93 | D88KARL | Right |



D88K 2 3/16" PIN & COTTER
HANNA PARTS

| | |
|---------------|---------------|
| \$2.65 | D88KDP |
|---------------|---------------|



D88K 2 7/16" PIN & COTTER
HANNA PARTS

| | |
|---------------|----------------|
| \$3.65 | D88KDPL |
|---------------|----------------|



STAINLESS STEEL COTTER ONLY
HANNA PARTS

| | |
|---------------|----------------|
| \$0.30 | D88KS-S |
|---------------|----------------|



D88K M2 LINK
HANNA PARTS

| | |
|----------------|---------------|
| \$11.01 | D88KM2 |
|----------------|---------------|



C188 - 7/8" RIGHT OR LEFT LINK
HANNA PARTS

| | |
|---------------|--------------|
| \$4.58 | TRIPL |
|---------------|--------------|



C188 PIN & COTTER
HANNA PARTS

| | |
|---------------|-------------|
| \$1.95 | 188P |
|---------------|-------------|



D667K TRIANGLE PLATE
HANNA PARTS

| | | |
|---------------|--------------|------|
| \$2.10 | D667L | Left |
|---------------|--------------|------|

CONVEYOR CORRELATOR/COUPLERS



HYTREL PLASTIC

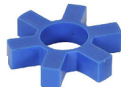

URETHANE PLASTIC



BUNA RUBBER

LOVEJOY SPIDERS
HANNA PARTS

| PRICE | PART # | DESCRIPTION | MATERIAL | COLOR |
|----------------|----------------|------------------------|------------------|-------|
| \$26.73 | FCS075H | L075/AL075 | Hytrel Plastic | Tan |
| \$35.66 | FCS090H | L090/AL090, L095/AL095 | Hytrel Plastic | Tan |
| \$84.89 | FCS099H | L099/AL099, L100/AL100 | Hytrel Plastic | Tan |
| \$9.10 | FCS075B | L075/AL075 | Buna Rubber | Black |
| \$11.79 | FCS090B | L090/AL090, L095/AL095 | Buna Rubber | Black |
| \$24.82 | FCS099B | L099/AL099, L100/AL100 | Buna Rubber | Black |
| \$49.22 | FCS099U | L099/AL099, L100/AL100 | Urethane Plastic | Blue |
| \$96.43 | FCS110U | L110/AL110 | Urethane Plastic | Blue |



SPLIT



NOT SPLIT

EPDM FLEX COUPLINGS
HANNA PARTS

| PRICE | PART # | STYLE |
|----------------|---------------|-----------|
| \$15.33 | FC4JES | Split |
| \$26.84 | FC5JES | Split |
| \$41.83 | FC6JES | Split |
| \$53.67 | FC7JES | Split |
| \$49.84 | FC7JE | Not Split |
| \$72.83 | FC8JES | Split |



3/8-16" REPLACEMENT NUT
HANNA PARTS

| | |
|---------------|----------------|
| \$0.15 | AC1-NUT |
|---------------|----------------|

TIRE WASHER & TIRE BRUSH PARTS



1" ALUMINUM COUPLERS
HANNA PARTS

| | |
|----------------|------------|
| \$25.54 | AC1 |
|----------------|------------|



4 1/2" LONG 4 BOLT SPINDLE
HANNA PARTS

- 1 1/4" shaft down to 1" with key

| | |
|----------------|-----------------|
| \$79.58 | UBA42016 |
|----------------|-----------------|

96" STANDARD TIRE BRUSHES (NYLON/POLY MIX)
HANNA PARTS

- Shaft: Bolt Adapter

| PRICE | PART # | COLOR |
|-----------------|----------------|-------|
| \$920.97 | UB504BK | Black |
| \$920.97 | UB504BL | Blue |
| \$920.97 | UB504R | Red |

96" BOLT ADAPTER POODLE PLUS BRUSH WITH SPINDLES
HANNA PARTS

| PRICE | PART # | COLOR |
|-----------------|----------------|-------|
| \$994.89 | UB500BK | Black |
| \$994.89 | UB500BL | Blue |
| \$994.89 | UB500R | Red |

TIRE BRUSH & ROCKER PARTS



1 1/4" AMI BEARING INSERTS
HANNA PARTS

| PRICE | KR PART # | MFG. PART # |
|----------------|----------------|-------------|
| \$24.57 | UC20720 | UC206-20 |

CHAR-LYNN® H SERIES MOTOR
HANNA PARTS

- **MAXIMUM CASE PRESSURE:** 1500 PSI
- **MAXIMUM TEMPERATURE:** 180°F
- **FLUID VISCOSITY:** Minimum viscosity at operating temperature should be the highest of the following: 10 SUS or (20 X PSI)/RPM=SUS

| PRICE | PART# | DESCRIPTION | DISPLACEMENT | RPM/3 GPM | RPM/6 GPM | PSI |
|-----------------|-----------------------|------------------|--------------|-----------|-----------|------------------------------------|
| \$277.81 | CL101-1001-009 | Motor, 1/4" Ring | 2.8 | 235 | 471 | 1800 continuous, 2400 intermittent |
| \$285.48 | CL101-1002-009 | Motor, 3/8" Ring | 4.5 | 150 | 296 | 1800 continuous, 2400 intermittent |
| \$341.77 | CL101-1004-009 | Motor, 7/8" Ring | 9.7 | 70 | 140 | |

WANT TO LEARN MORE ABOUT CHAR-LYNN® MOTORS?

Check out the featured product spotlight on page 554!

HANNA™ REPLACEMENT PRODUCTS

HYDRAULIC MOTORS



CLP22000-2

CHAR-LYNN® H SERIES MOTOR - 1/2" FPT

HANNA PARTS

- **MAXIMUM CASE PRESSURE:** 1500 PSI
- **MAXIMUM TEMPERATURE:** 180°F
- **FLUID VISCOSITY:** Minimum viscosity at operating temperature should be the highest of the following: 10 SUS or (20 X PSI)/RPM=SUS

| PRICE | PART# | DESCRIPTION | DISPLACEMENT | RPM/3 GPM | RPM/6 GPM | RING SIZE |
|----------|----------------|-----------------------------|--------------|-----------|-----------|-----------|
| \$277.81 | CL101-1001-009 | Motor, 1/4" Ring | 2.8 | 235 | 471 | 1/4" |
| \$285.48 | CL101-1002-009 | Motor, 3/8" Ring | 4.5 | 150 | 296 | 3/8" |
| \$293.92 | CL101-1003-009 | Motor, 1/2" Ring | 5.9 | 115 | 230 | 1/2" |
| \$341.77 | CL101-1004-009 | Motor, 7/8" Ring | 9.7 | 70 | 140 | 7/8" |
| \$354.55 | CL101-1005-009 | Motor, 1" Ring | 11.3 | 60 | 120 | 1" |
| \$349.18 | CL101-1006-009 | Motor, 1 1/4" Ring | 14.1 | 48 | 95 | 1 1/4" |
| \$369.15 | CL101-1007-009 | Motor, 1 1/2" Ring | 17.9 | 38 | 75 | 1 1/2" |
| \$403.67 | CL101-1008-009 | Motor, 2" Ring | 22.6 | 30 | 60 | 2" |
| \$95.75 | CLP22000-2 | 4 Bolt Mount Flange 009-010 | | | | |
| \$66.31 | CLP60540 | Seal Kit 009 | | | | |

CHAR-LYNN® S-PLUS MOTOR - 1/2" FPT

HANNA PARTS

- **MAXIMUM CASE PRESSURE:** 1500 PSI
- **MAXIMUM TEMPERATURE:** 180°F
- **FLUID VISCOSITY:** 70 SUS at operating temperature



| PRICE | PART# | DESCRIPTION | DISPLACEMENT | RPM/3 GPM | RPM/6 GPM | RING SIZE |
|----------|----------------|-----------------------------|--------------|-----------|-----------|-----------|
| \$418.29 | CL103-1002-012 | Motor, 3/8" Ring | 4.5 | 146 | 293 | 3/8" |
| \$423.64 | CL103-1003-012 | Motor, 1/2" Ring | 5.9 | 112 | 225 | 1/2" |
| \$448.21 | CL103-1004-012 | Motor, 7/8" Ring | 9.7 | 68 | 136 | 7/8" |
| \$459.71 | CL103-1005-012 | Motor, 1" Ring | 11.3 | 58 | 117 | 1" |
| \$480.44 | CL103-1006-012 | Motor, 1 1/4" Ring | 14.1 | 47 | 95 | 1 1/4" |
| \$539.52 | CL103-1008-012 | Motor, 2" Ring | 22.6 | 30 | 60 | 2" |
| \$95.75 | CLP22000-2 | 4 Bolt Mount Flange 009-010 | | | | |
| \$58.68 | CLP9900101 | Hydraulic Motor Seal Kit | | | | |

CHAR-LYNN® S-PLUS MOTOR - 7/8" -14 SAE O-RING

HANNA PARTS

- **MAXIMUM CASE PRESSURE:** 1500 PSI
- **MAXIMUM TEMPERATURE:** 180°F

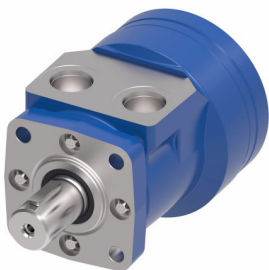

| PRICE | PART# | DISPLACEMENT | MAX RPM | SHAFT | PORT | RING SIZE |
|----------|----------------|--------------|---------|-------|----------|-----------|
| \$556.85 | CL103-3581-012 | 3.6 | 963 | 1" | 7/8" SAE | 1 9/64" |

MITTER MOTORS & REPLACEMENT PARTS



ROD ENDS - MALE THREADED RIGHT HAND WITH ZERK (GREASE FITTING) - 3 PIECE - COMMERCIAL - SINTERED BRONZE

HANNA PARTS

| PRICE | KR PART # | MFG. PART # | SIZE |
|---------|-----------|-------------|------|
| \$14.71 | VM8G | M8SBZ | 1/2" |
| \$25.14 | VM12G | M12SBZ | 3/4" |



CHAR-LYNN® S SERIES MOTOR - 1/2" -14 FPT

HANNA PARTS

- **MAX. CASE PRESSURE:** 1500 PSI
- **MAX. TEMPERATURE:** 180°F

| PRICE | PART# | DISPLACEMENT | SHAFT | RING SIZE |
|----------|----------------|--------------|-------|--------------|
| \$556.85 | CL103-2030-012 | 14.10 | 1" | 7/16"-20 UNF |

HANNA™ REPLACEMENT PRODUCTS

PUMPS - VALVES - HYDROMINDERS

FLOJET G57 SERIES AIR-OPERATED PUMPS

HANNA PARTS



- MAX FLOW RATE: 5 GPM
- PRESSURE RATING: 20-100 PSI
- AIR INLET: 1/4" brass hose barb
- PRODUCT INLET: 1/2" hose barb
- PRODUCT OUTLET: 1/2" hose barb

| PRICE | PART # | DIAPHRAGM | PORT KIT |
|-----------------|--------|------------|----------|
| \$102.17 | FP7040 | SANTOPRENE | FPK06B |
| \$142.99 | FP7020 | VITON | FPK06V |



FLOJET G57 SERIES AIR-OPERATED PUMPS

HANNA PARTS



- MAX FLOW RATE: 5 GPM
- PRESSURE RATING: 20-100 PSI
- AIR CONSUMPTION: 1 SCFM at 100 PSI
- AIR INLET: 1/4" brass hose barb
- PRODUCT INLET: 1/2" PushLock
- PRODUCT OUTLET: 1/2" PushLock

| PRICE | PART # | DIAPHRAGM |
|-----------------|----------|------------|
| \$168.30 | FP575145 | SANTOPRENE |
| \$181.52 | FP573145 | VITON |
| \$237.03 | FP57142 | KALREZ |



PUSH LOCK & STEP-DOWN BARB FITTINGS

HANNA PARTS



| PRICE | PART # | DIAPHRAGM |
|----------------|---------|--|
| \$5.91 | FPK06V | FLOJET HOSE BARB - Viton - 3/8" x 1/2" |
| \$14.88 | FPK06PT | FLOJET PUSH-IN POLYTUBE FITTING - VITON - 3/8" |
| \$24.38 | FPK08PT | FLOJET PUSH-IN POLYTUB FITTING - Viton - 1/2" |

| PRICE | PART # | DIAPHRAGM |
|----------------|-------------|-----------------------------------|
| \$20.79 | FPK20381061 | FLOJET PUSH-IN TUBE - EPDM - 1/2" |
| \$3.89 | FPK01510 | FLOJET BRASS AIR INLET - 1/4" |

511 HYDROMINDER - LOW VOLUME UNIT WITH SIPHON BEAKER (4½ GPM)

HANNA PARTS



\$161.84 IN511

515 HYDROMINDER - LOW VOLUME UNIT WITH SIPHON BEAKER & MOUNTING BRACKET (1½ GPM)

HANNA PARTS



\$203.62 IN515

530 HYDROMINDER - MEDIUM VOLUME UNIT WITH SIPHON BEAKER & MOUNTING BRACKET (1½ GPM)

HANNA PARTS



\$301.08 IN530

VALVES - INJECTORS

DEMA PILOT-PISTON NORMALLY CLOSED SOLENOID VALVES

HANNA PARTS



- BODY: Brass
- SEAL: Teflon
- PRESSURE RATING: 3-150 PSI
- JUNCTION BOX: 24V / 110V

| PRICE | PART # | SIZE | VOLTAGE | PRICE | PART # | SIZE | VOLTAGE |
|----------------|------------|------|---------|----------------|------------|------|---------|
| \$70.89 | SOD414P24 | 1/2" | 24V | \$97.56 | SOD416P24 | 3/4" | 24V |
| \$70.89 | SOD414P120 | 1/2" | 120V | \$97.55 | SOD416P120 | 3/4" | 120V |



DEMA 204B 1/2" ADJUSTABLE INJECTOR

HANNA PARTS



- Brass
- Screw adjustable
- 2.0 - 35 GPM
- Max. Induction: 36 oz/min

\$64.88 IN204B

DEMA 206B 3/4" ADJUSTABLE INJECTOR

HANNA PARTS



- Brass
- Screw adjustable
- 11 - 39 GPM
- Max. Induction: 42 oz/min

\$81.26 IN206B

CONDUIT COIL

HANNA PARTS



- 10 Watts (AC)
- 1/2" NPT conduit
- Class F

\$53.36 SOPC500 24V AC
\$53.37 SOPC505 110V

1/4" 3 WAY SOLENOID

HANNA PARTS



- 24V AC
- 1/2" NPT Conduit
- Rotates 360° for easy installation

\$159.04 SOP1135

CALIFORNIA PROPOSITION 65 NOTE: some items on this page may fall under the Proposition 65 act. Please consult the State of California Proposition 65 list (oehha.ca.gov/proposition-65/proposition-65-list) to learn more and to see a comprehensive list of Proposition 65 chemicals.

HANNA™ REPLACEMENT PRODUCTS

WATER WIZARD REPLACEMENT PARTS



DEMA STAINLESS STEEL DIRECT ACTING 1/4" SOLENOID VALVE

HANNA PARTS

- **BODY:** Stainless Steel • **SEAL:** Buna-N
- **MAX PRESSURE:** 150 PSI • **INLET/OUTLET:** 1/4" NPT
- 24V AC

CALL SOD42424



DEMA SOLENOID REPAIR KITS

HANNA PARTS

| | | |
|----------------|-----------------|-------------------------------|
| \$46.92 | SODK4131 | 3/8" Repair Kit - 453P Models |
| \$39.98 | SODK4132 | 1/2" Repair Kit - 454P Models |
| \$70.83 | SODK4133 | 1" Repair Kit - 458P Models |



DEMA 24V HIGH PRESSURE SOLENOID VALVES - BRASS BODY - TEFLON SEAL

HANNA PARTS

| | | |
|-----------------|------------------|------|
| \$85.31 | SOD453P24 | 3/8" |
| \$128.54 | SOD454P24 | 1/2" |
| \$219.15 | SOD458P24 | 1" |



90° 3/8" MOSMATIC SWIVEL

HANNA PARTS

\$92.68 SWM43262



WATLOW 240V 1" TANK HEATER

HANNA™ PARTS

- Heats to 110°F
- With thermostat
- Stainless steel construction

\$218.44 WH0500



DEMA 24VAC 2 COIL JUNCTION BOX

HANNA PARTS

CALL SODP419C2348



GENERAL PUMP® TRAPPED PRESSURE UNLOADER

HANNA PARTS

- **PRESSURE:** 2450 PSI • **INLET:** 1" NPTF
- **MAX FLOW:** 53 GPM • **OUTLET:** 1" NPTF
- **BYPASS:** 1" NPTF • **MAX. TEMP:** 200°F

\$353.35 GPU5221



0-3000 PSI LIQUID FILLED 1/4" PRESSURE GAUGE - REAR MOUNT

HANNA PARTS

\$15.00 GAL3000R

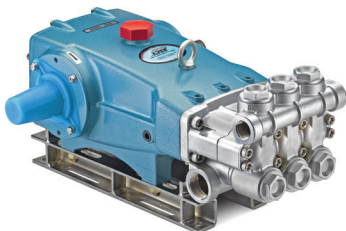

CAT PUMPS® 3535 SERIES CERAMIC PLUNGER PUMP

HANNA PARTS

- **FLOW:** 36 GPM
- **PRESSURE:** 100 - 1200 PSI
- **RPM:** 800 RPM

\$4,660.68 PU03535



CAT PUMPS® 3535 SERIES KITS & OIL

HANNA PARTS

| PART # | DESCRIPTION | KITS NEEDED |
|----------------------|-------------|---------------|
| PU34235 | Valve Kit | x 2 |
| PU31040 | Seal Kit | x 1 |
| PU92674 | Pump Rails | - |
| Factory Sized | Pump Pulley | - |
| PU06100 | | 21 oz. bottle |
| PU06105 | | 2.5 gallons |

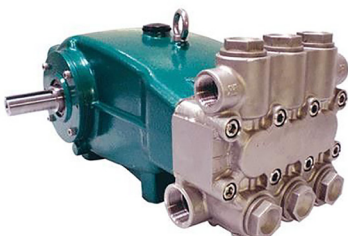

ARIMITSU® 3615 SERIES DUAL SHAFT PUMP

HANNA PARTS

- **FLOW:** 36 GPM
- **PRESSURE:** 1600 PSI
- **RPM:** 800 RPM

CALL ARM3615



ARIMITSU® 3615 SERIES KITS & OIL

HANNA PARTS

| PART # | DESCRIPTION |
|-----------------|-----------------------|
| ARM30136 | Seal Kit |
| ARM30137 | Valve Kit |
| ARM30103 | Arimitsu Oil - 32 oz. |

CALIFORNIA PROPOSITION 65 NOTE: some items on this page may fall under the Proposition 65 act. Please consult the State of California Proposition 65 list (oehha.ca.gov/proposition-65/proposition-65-list) to learn more and to see a comprehensive list of Proposition 65 chemicals.

HANNA™ REPLACEMENT PRODUCTS

AUTO PREP WASHER PARTS



D25-X HYDRA-CELL PUMP

HANNA PARTS

- MAX FLOW: 20 GPM
- MAX TEMP: 250°F
- INLET: 1½"
- SHAFT DIAMETER: 1⅞"
- MAX PSI: 1000
- MAX RPM: 1050
- OUTLET: 1" NPT

\$3,274.14 WPH25XKBTH

D25-X HYDRA-CELL PUMP PARTS

HANNA PARTS

| | | |
|-----------------|--------------|------------------------|
| \$17.66 | WPD030391030 | Oil Fill Cap W/ O-Ring |
| \$86.80 | WPD25D52TX | H25 Diaphragm |
| \$306.88 | D25K52THFEC | H25 Repair Kit |
| \$192.23 | WPA031751102 | H/G-25 Tool Kit |
| \$677.83 | WPA031751107 | Master Tool Kit |



WANNER 1" REGULATOR VALVE

HANNA PARTS

- FLOW: 20 GPM
- PSI: 500-1000

\$368.55 WPC23ABBNSJG



WANNER ¾" REGULATOR VALVE

HANNA PARTS

- MAX. FLOW: 14 GPM
- PSI: 500-2500

\$331.50 WPC62ABBSSEF



3 PHASE BALDOR MOTOR 10 HP/1750 RPM/TEFC

HANNA PARTS

\$1,738.77 MBEM3313T



GENERAL PUMP® ¼" SPRAY TIP

HANNA PARTS

| PRICE | PART # | TYPE |
|---------------|-----------|------|
| \$3.79 | GPN1504M4 | 1504 |

MACNEIL®

MACNEIL® REPLACEMENT PRODUCTS

RG44 CONVEYOR WASH PARTS



BELL SIGNAL HOSE

MACNEIL PARTS

- ¾" hose • .110 wall

\$1.00 / FT H00150



LLDPE POLY TUBING

MACNEIL PARTS

- ¾" hose • 120 PSI • 100 ft

\$30.15 PT300BK-100



#16 NORMALLY OPEN AIR SWITCH

MACNEIL PARTS

\$15.80 AS16



HYDRAULIC & ELECTRIC DRIVES



2000 SERIES CHAR-LYNN® MOTORS

MACNEIL PARTS

| PRICE | PART# | DESCRIPTION |
|-----------------|----------------|----------------------|
| \$656.86 | CL106-1014-006 | Motor, 18.7 cu"/ Rev |
| \$686.22 | CL106-1015-006 | Motor, 24.9 cu"/ Rev |



1760RPM/182TC 230/460 STERLING MOTOR

MACNEIL PARTS

| PRICE | PART# | DESCRIPTION |
|-----------------|---------|-------------|
| \$764.50 | MSE3000 | 3 HP |
| \$843.50 | MSE3005 | 5 HP |

ROLLERS & CHAIN



CHAIN SECTIONS

MACNEIL PARTS

- Sold in 10' sections
- Price is per 10'

\$102.10 X458



BAR

MACNEIL PARTS

\$4.75 X458BAR



CARRIER LINK

MACNEIL PARTS

\$25.61 CLX348



PIN

MACNEIL PARTS

\$2.40 X458PIN



CENTER LINK

MACNEIL PARTS

\$3.85 X458LINK

ROLLERS & CHAIN



ROD ENDS - ½" FEMALE THREADED RIGHT HAND WITH ZERK (GREASE FITTING) - 3 PIECE - COMMERCIAL - SINTERED BRONZE

AUTOMATICS HARDWARE

| PRICE | KR PART # | MFG. PART # |
|----------------|-----------|-------------|
| \$13.81 | VF8G | F8SBZ |

CHECK VALVES



CHECK VALVE WITH VITON SEALS

MACNEIL PARTS

| PRICE | PART# | DESCRIPTION |
|----------------|-------------|------------------------|
| \$10.88 | CV0090-4F4P | ¼" F X ¼" PUSH CONNECT |
| \$11.03 | CV0090-4F6P | ¼" F X ⅜" PUSH CONNECT |

CALIFORNIA PROPOSITION 65 NOTE: some items on this page may fall under the Proposition 65 act. Please consult the State of California Proposition 65 list (oehha.ca.gov/proposition-65/proposition-65-list) to learn more and to see a comprehensive list of Proposition 65 chemicals.

AUTOMATICS & TUNNELS

SOUTHERN PRIDE® REPLACEMENT PRODUCTS

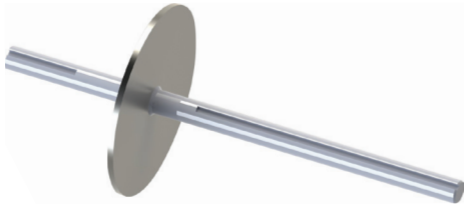

DRIVE SHAFT ASSEMBLY
SOUTHERN PRIDE REPLACEMENT PARTS

• Southern Pride # 372264A, 247033, 247038

\$321.33 SP2135

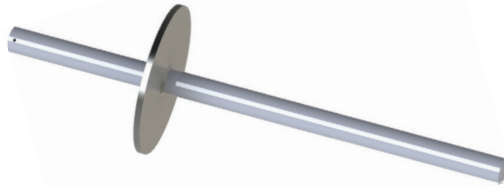

IDLER SHAFT ASSEMBLY
SOUTHERN PRIDE REPLACEMENT PARTS

• Southern Pride # 372663, 247037, 247039

\$303.98 SP2130

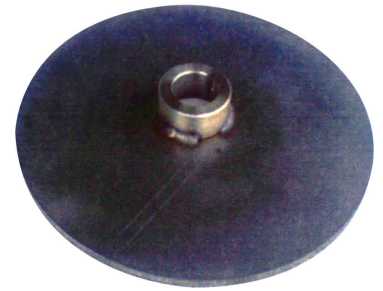

DRIVE ASSEMBLY PLATE
SOUTHERN PRIDE REPLACEMENT PARTS

• Southern Pride # 370269

\$122.85 SP2125



DISC ASSEMBLY
SOUTHERN PRIDE REPLACEMENT PARTS

• Southern Pride # 370269

\$122.85 SP2115



BEARING HOUSE ASSEMBLY
SOUTHERN PRIDE REPLACEMENT PARTS

• Southern Pride # 372908

CALL SP2110

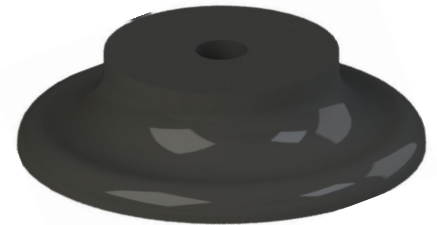

DRIVE ROLLER & (2) 8" DRIVE DISCS
SOUTHERN PRIDE REPLACEMENT PARTS

• Southern Pride # 247033, 247038

\$40.20 HSAP92016

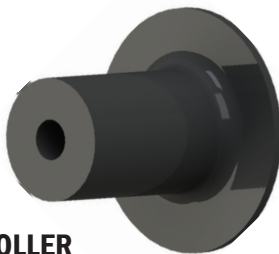

6" IDLER DISC & ROLLER
SOUTHERN PRIDE REPLACEMENT PARTS

• Southern Pride # 247037, 247039

\$40.20 HSAP92017



BRASS SPINDLES
SOUTHERN PRIDE REPLACEMENT PARTS

| | | | |
|-----------------|--------|--------|------------|
| \$142.71 | SP2100 | 2 Hole | SP# 370203 |
| \$139.35 | SP2105 | 3 Hole | SP# 370205 |



SKYTRACK IDLER & DRIVE WHEEL
SOUTHERN PRIDE REPLACEMENT PARTS

\$87.48 SP2150



8" DRIVE ROLLER DISC
SOUTHERN PRIDE REPLACEMENT PARTS

\$86.71 SP0019

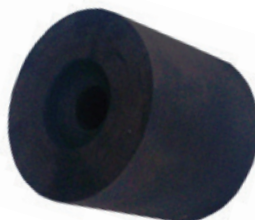

DRIVE ROLLER
SOUTHERN PRIDE REPLACEMENT PARTS

\$68.85 SP0021



ROLLER GUIDE ASSEMBLY
SOUTHERN PRIDE REPLACEMENT PARTS

• Southern Pride # 370337

\$75.55 SP2140



1" CASTLE NUT
SOUTHERN PRIDE REPLACEMENT PARTS

• Southern Pride # 372667

\$13.15 HSCS82153A

AUTOMATICS & TUNNELS

LASERWASH G5™ REPLACEMENT PARTS

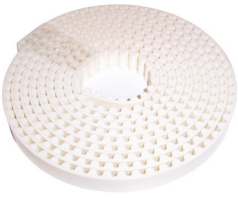

TROLLEY DRIVE BELT
LASERWASH REPLACEMENT PARTS

\$103.44 BB1000



BRIDGE DRIVE BELT
LASERWASH REPLACEMENT PARTS

\$299.79 BB1001



ARCH ENCODER
LASERWASH REPLACEMENT PARTS

\$255.25 BB1002



BRIDGE ENCODER
LASERWASH REPLACEMENT PARTS

\$255.25 BB1003

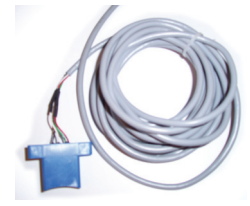

TROLLEY ENCODER
LASERWASH REPLACEMENT PARTS

\$255.29 BB1004

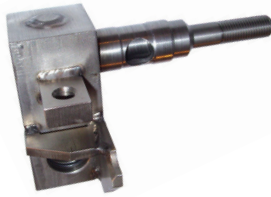

MANIFOLD BLOCK 1ST BREAKAWAY
LASERWASH REPLACEMENT PARTS

CALL BB1023



MANIFOLD BLOCK 1ST BREAKAWAY
LASERWASH REPLACEMENT PARTS

CALL BB1007



SWIVEL
LASERWASH REPLACEMENT PARTS

\$786.36 SWM40936



BREAKAWAY ASSEMBLY BOLT
LASERWASH REPLACEMENT PARTS

\$98.18 BB1009



BRIDGE BEARING MAIN DRIVE SHAFT
LASERWASH REPLACEMENT PARTS

\$63.55 BB1010



LOWER BEARING CENTRAL BRIDGE FRAME
LASERWASH REPLACEMENT PARTS

\$58.86 BB1011



UPPER BEARING CENTRAL BRIDGE FRAME
LASERWASH REPLACEMENT PARTS

\$58.88 BB1012



BRIDGE & DRYER SHAFT
LASERWASH REPLACEMENT PARTS

CALL BB1013



BRIDGE IDLER ROLLER
LASERWASH REPLACEMENT PARTS

\$76.83 BB1020



INNER ROLLER TROLLEY
LASERWASH REPLACEMENT PARTS

\$131.72 BB1021



DRIVER SIDE TROLLEY SHAFT
LASERWASH REPLACEMENT PARTS

CALL BB1022



OUTER ROLLER TROLLEY
LASERWASH REPLACEMENT PARTS

\$51.83 BB1024



BRIDGE ROLLER W/ BELT RELIEF
LASERWASH REPLACEMENT PARTS

\$72.14 BB1025



BRIDGE & DRYER GUIDE ROLLER SHAFT
REPLACEMENT PARTS

CALL BB1014



TROLLEY RETAINER ROLLER
REPLACEMENT PARTS

CALL BB1015



BRIDGE FRAME SHAFT
REPLACEMENT PARTS

\$93.91 BB1016



BRONZE BOLT SPRAY ARCH
REPLACEMENT PARTS

CALL BB1008



IDLER ROLLER SHAFT BRIDGE
REPLACEMENT PARTS

CALL BB1017



BRIDGE & DRYER ROLLER DELRIN
REPLACEMENT PARTS

\$58.26 BB1018



TROLLEY RETAINER ROLLER
REPLACEMENT PARTS

\$125.92 BB1019

AUTOMATICS & TUNNELS

POPULAR REPLACEMENT PARTS



CLEAR VINYL TUBE
1/4" I.D. x 3/8" O.D.
KLEEN-RITE HOSES

\$0.25 HCV04T



3/4" FLOAT VALVE
WALTER VALVES

\$43.20 FVW12

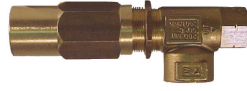

BALANCED PRESSURE REGULATORS
REPLACEMENT PARTS

\$163.35 REK5325 3/4" 2900 PSI
\$35.91 RE7075 3/8" 2000 PSI

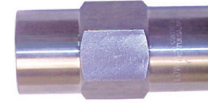

CHECK VALVE - STAINLESS STEEL TEFLON
FLUID CONTROLS

\$25.35 CV0041T 3/8 HP
\$32.64 CV0071T 1/2 F x F
\$44.43 CV0080T 3/4 F x F



REGULATOR AIR 1/4" MINI
PARKER REGULATORS

\$24.92 REP119

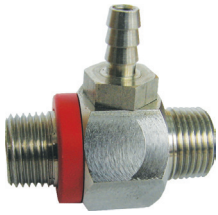

STAINLESS STEEL CHEMICAL INJECTORS
GENERAL PUMP

\$37.40 GPP100333 .087
\$37.40 GPP100334 .083
\$37.40 GPP100336 .057



1" F x F SWIVEL
SUPER SWIVELS

\$112.26 SWSD169FF 90°
\$140.32 SWSD1601 Straight



MAC SOLENOID 4 WAY
1/4" 24V 150 PSI
AUTOMATICS PARTS

\$106.12 MAC2180



3/8" SOLENOID VALVE (LESS COIL)
DANFOSS VALVES

\$64.90 DF06LC



DANFOSS 24V AC SOLENOID COIL
DANFOSS

\$29.57 DF042N7520



FESTOONS - 5" TROLLEY, 3" SADDLE
AUTOMATICS PARTS

| PRICE | PART # | DESCRIPTION |
|----------------|------------|-----------------------|
| \$17.60 | AMLFCTR1 | Heavy Duty Galvanized |
| \$59.73 | AMLFCTR1SS | Stainless Steel |
| \$24.38 | AM33293 | Plastic |



4 1/2" SHEAR PIN BOLT
AUTOMATICS PARTS

\$5.99 AMLSB



BELANGER® VECTOR CARRIAGE SHUTTLE REPLACEMENT ROLLER
AUTOMATICS PARTS

• (4) per machine
\$191.87 7X4BLKWHLB



BRIDGE ROLLERS
AUTOMATICS PARTS

\$49.17 AMLBRW White
\$49.17 AMLBRBK Black



TIRE INNERTUBE 410-4
AUTOMATICS PARTS

\$17.75 AMLTUBE



TIRE 410/3 1/2-4 2-PLY TUBE TYPE
AUTOMATICS PARTS

\$27.75 AMLTIRE



TIRE RIM 4 x 1 5/16" STAINLESS STEEL
AUTOMATICS PARTS

\$27.99 AMLRIM-S



LASERWASH 4000 SPRAY TIPS BUNDLE
KLEEN-RITE KITS

- FOR AUTOMATIC CAR WASH SYSTEMS
- (11) SA1/4MEG-1504 Spraying Systems 1504 WashJet Spray Tip 1/4"
- (5) SA1/4MEG-1503 Spraying Systems 1503 WashJet Spray Tip 1/4"
- (1) SA1/4MEG-2503 Spraying Systems 2503 WashJet Spray Tip 1/4"
- (1) SA1/4MEG-4003 Spraying Systems 4003 WashJet Spray Tip 1/4"

\$60.43 KRK5000

AUTOMATICS & TUNNELS

D & S® REPLACEMENT PARTS



IDLER WHEEL

D&S REPLACEMENT PARTS

- D&S # 5WHL200-2

\$81.25 DS8130

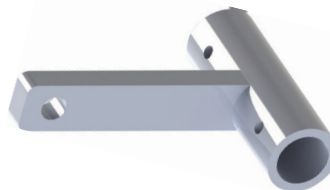

IDLER ARM SPRING HOLDER

D&S REPLACEMENT PARTS

- D&S # 5IDL615

\$116.13 DS8125

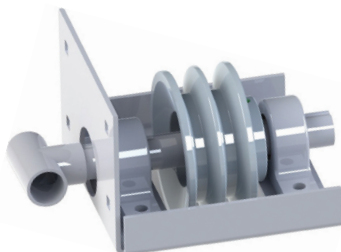

DOUBLE PULLEY SPINNER

D&S REPLACEMENT PARTS

- D&S # 5BER200

\$514.75 DS8115

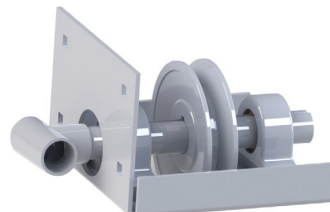

SINGLE PULLEY SPINNER

D&S REPLACEMENT PARTS

- D&S # 5BER100

\$278.11 DS8110



IDLER BAR ASSEMBLY

D&S REPLACEMENT PARTS

- D&S # 5IDL310

\$207.45 DS8120



T BAR

D&S REPLACEMENT PARTS

\$81.86 SWMTB87837

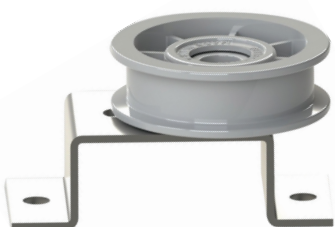

SINGLE PULLEY BELT TIGHTENER

D&S REPLACEMENT PARTS

- D&S # 5GAN618

\$142.71 DS8105



DOUBLE PULLEY BELT TIGHTENER

D&S REPLACEMENT PARTS

- D&S # 5PUL604

\$201.31 DS8100



90° 3/8" SWIVEL

D&S REPLACEMENT PARTS

\$92.68 SWM43262



3/8" M x F SWIVEL

D&S REPLACEMENT PARTS

\$144.81 SWM37163

AUTOMATICS & TUNNELS

PROXIMITY SWITCHES & SENSORS



STP2120



STP2080

PROXIMITY SWITCHES FROM TELEMECANIQUE FOR USE IN AUTOMATIC CAR WASHES

TELEMECANIQUE

| PRICE | PART # | MFG # | DESCRIPTION |
|----------|---------|--------------|--|
| \$185.46 | STP2000 | XS1M18PAS40D | Proximity Switch 24VDC 200MA |
| \$115.23 | STP2060 | XS4P30MA230 | Inductive Proximity Switch |
| \$88.74 | STP2090 | XS612B1NAM12 | M12 Connector/ 4mm Sensing Distance/ 12mm Dia |
| \$102.79 | STP2080 | XS530B1NAM12 | M12 Connector/ 10mm Sensing Distance/ 30mm Dia |
| \$117.16 | STP2100 | XS618B1NAM12 | 18mm, M12 Connector, 8mm Sensing Distance |
| \$117.57 | STP2110 | XS1M30MA230K | 3-Pin/ 10mm Sensing Distance/ 30mm Dia |
| \$107.11 | STP2120 | XS630B1NAM12 | 30mm Thread, 15mm Sensor with Connector |
| \$38.65 | STP2150 | XS118BLPAM12 | Square-D Inductive Sensor - 18mm Shielded |
| \$82.27 | STP2276 | XS518B1NAM12 | XS5 M18 OxiSense XS 50mm x 18mm Sensor 4-Pin M12 connector |



OSISENSE XM PRESSURE TRANSMITTER SENSOR

TELEMECANIQUE

- Used to measure and regulate fluid and steam pressure. Commonly used with booster pumps in car wash systems.
- PRESSURE SENSOR SIZE:** 300 PSI
- TEMPERATURE RANGE:** 32° to 176°F
- FLUID CONNECTION TYPE:** ¼" - 18 NPT (male)
- ELECTRICAL CONNECTION:** 1 male connector M12 4 pins

\$114.45 STP3000



STPCV1G2M



STPCV1G5M



STPCV1WYE2M



STPCV1WYE5M

SENSOR CABLE FOR PROXIMITY SWITCH

MURR ELEKTRONIK

| PRICE | PART | SIZE |
|---------|-------------|------------------|
| \$17.74 | STPCV1G2M | 6' Straight end |
| \$20.46 | STPCV1G5M | 12' Straight end |
| \$17.84 | STPCV1WYE2M | 6' Right angle |
| \$40.08 | STPCV1WYE5M | 12' Right angle |



TPS1001



TPS1015



TPS1055



TPS1020

PROXIMITY SWITCHES

TURCK SENSORS

TURCK

| PRICE | PART # | TURCK # | DESCRIPTION | CONNECTION |
|----------|---------|-------------------------------|------------------|--------------------------|
| \$128.57 | TPS1000 | NI15U-EM18WD-AN6X-H1141 | Inductive Sensor | Quick Disconnect |
| \$119.56 | TPS1001 | NI12U-EM18WD-AN6X-H1141/S1163 | Proximity Switch | Quick Disconnect |
| \$322.57 | TPS1010 | NI75U-CP80-AN6X2-H1141 | Proximity Switch | Quick Disconnect |
| \$288.78 | TPS1020 | NI75U-CP80-AN6X2 | Inductive Sensor | Wire Leads |
| \$98.61 | TPS1025 | BI10-P30-AN6X-B2141 | Inductive Sensor | Quick Disconnect |
| \$98.61 | TPS1030 | BI5-S18-AD4X-H1141 | Inductive Sensor | Quick Disconnect |
| \$109.97 | TPS1035 | NI12U-M18-AN6X-H1141 | Inductive Sensor | Quick Disconnect |
| \$105.93 | TPS1040 | BI10U-EM30-AN6X-H1141 | Inductive Sensor | Quick Disconnect |
| \$113.60 | TPS1045 | NI20U-EM30-AP6X-H1141 | Inductive Sensor | Quick Disconnect |
| \$322.57 | TPS1055 | NI75U-CP80-AP6X2-H1141 | Pancake Switch | Quick Disconnect |
| \$148.32 | TPS1060 | NI20U-EM30-AN6X-H1141 | Inductive Sensor | Quick Disconnect |
| \$126.41 | TPS1090 | BI10-S30AZ3X7M | Proximity Switch | Wire Leads |
| \$135.44 | TPS1140 | BI15-EM30-AN45XLD-0.2MRS4T | Proximity Switch | Pigtail Quick Disconnect |
| \$237.88 | TPS1170 | BI15U-EM30PWD-AN6X-0.2M-RSV4T | Proximity Switch | Pigtail Quick Disconnect |
| \$98.61 | TPS1190 | BI10-S30-AD4X-H1141 | Inductive Sensor | Quick Disconnect |
| \$98.61 | TPS1195 | BI10-S30-AN6X-H1141 | Inductive Sensor | Quick Disconnect |

CORD SETS

TURCK SENSORS

TURCK



TPSC5050



TPSC5010

| PRICE | PART # | TURCK # | DESCRIPTION | CONNECTION |
|---------|----------|-----------------|----------------------------|--------------|
| \$36.68 | TPSC5000 | WK4.5T-10 | Cordset - 90°, 5 Wire | M12 Eurofast |
| \$29.07 | TPSC5010 | WK4.4T-4 | Cordset - 90°, 4 Wire | M12 Eurofast |
| \$35.86 | TPSC5015 | RKC4.4T-4 | Cordset - Straight, 4 Wire | M12 Eurofast |
| \$22.28 | TPSC5020 | RK4T-8 | Cordset - Straight, 3 Wire | M12 Eurofast |
| \$19.18 | TPSC5025 | RK4T-6 | Cordset - Straight, 3 Wire | M12 Eurofast |
| \$62.16 | TPSC5030 | RKC6V16-S618/NO | Cordset - Straight, 6 Wire | Wire Leads |
| \$12.95 | TPSC5035 | RK4T-2 | Cordset - Straight, 3 Wire | M12 Eurofast |
| \$19.18 | TPSC5040 | WK4T-6 | Cordset - 90°, 3 Wire | M12 Eurofast |
| \$39.56 | TPSC5045 | RKC4T-6 | Cordset - Straight, 3 Wire | M12 Eurofast |
| \$54.52 | TPSC5050 | WKV4.4T-6/S618 | Cordset - Straight, 4 Wire | Wire Leads |
| \$65.24 | TPSC5055 | WKV4.4T-15 | Cordset - 90°, 4 Wire | Wire Leads |
| \$65.24 | TPSC5060 | RKK4.4T-12 | Cordset - Straight, 4 Wire | Wire Leads |
| \$32.53 | TPSC5065 | WK4.4T-10 | Cordset - Straight, 4 Wire | M12 Eurofast |
| \$43.49 | TPSC5070 | WK4.4T-12 | Cordset - 90°, 4 Wire | M12 Eurofast |
| \$16.05 | TPSC5075 | WK4T-4 | Cordset - 90°, 3 Wire | M12 Eurofast |
| \$12.95 | TPSC5080 | WK4T-2 | Cordset - 90°, 3 Wire | M12 Eurofast |

AUTOMATICS & TUNNELS

SENSORS



PANTRON 24VAC & 115VAC PHOTO EYE KIT

PANTRON SENSOR TECHNOLOGY



INCLUDES:

- Transmitter with 15M (49') Cable (KR# PPST1005 / Pantron# IT-M12-15M)
- Amplifier, 24VAC (KR# PPSA0124-24 / Pantron# ISG-A124-24)
- Socket, 11-Pole (KR# PPSP3000 / Pantron# MB11)
- Enclosure (KR# PPSP3010 / Pantron# PanBox 1 x 1)
- Receiver w/ 15M (49') Cable (KR# PPSR1005 / Pantron# IR-M12-15M)

| | | |
|-----------------|---------------------|------------|
| \$329.83 | PPSK0015-24 | 24VAC Kit |
| \$329.83 | PPSK0015-115 | 115VAC Kit |

TRANSMITTERS & RECEIVERS

PANTRON SENSOR TECHNOLOGY

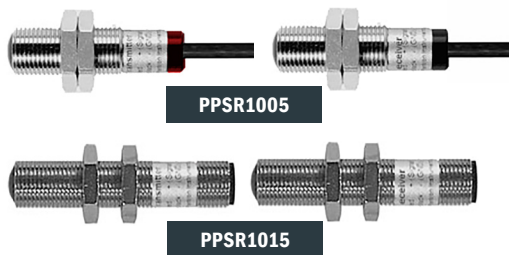

| | | | |
|-----------------|--------------------|---|--|
| \$107.07 | PPSR1005 | Pantron M12 Series Receiver | Nickel Plated Brass, 15M (49ft) Cable |
| \$71.28 | PPST1005 | Pantron M12 Series Transmitter | Nickel Plated Brass, 15M (49ft) Cable |
| \$80.80 | PPST1005-HP | Pantron M12 Series High Powered Transmitter | Nickel Plated Brass, 15M (49ft) Cable |
| \$150.51 | PPSR1010 | Pantron M12 Series Receiver | Nickel Plated Brass, 35M (114ft) Cable |
| \$101.02 | PPST1010 | Pantron M12 Series Transmitter | Nickel Plated Brass, 35M (114ft) Cable |
| \$95.87 | PPST1010-HP | Pantron M12 Series High Powered Transmitter | Nickel Plated Brass, 35M (114ft) Cable |
| \$58.02 | PPSR1015 | Pantron M12 Series Receiver | Nickel Plated Brass, M12 Connector |
| \$45.69 | PPST1015 | Pantron M12 Series Transmitter | Nickel Plated Brass, M12 Connector |
| \$53.09 | PPST1015-HP | Pantron M12 Series High Powered Transmitter | Nickel Plated Brass, M12 Connector |

CABLES (FOR QUICK CONNECT SENSORS)

PANTRON SENSOR TECHNOLOGY



ISG-A124 SERIES

ISG-A134 SERIES



| | | | |
|----------------|--------------------|--------------------------------------|---------------------|
| \$31.00 | PPSC2000-15 | Pantron Right Angle M12 Female Cable | 3-Wire, 15M (49ft) |
| \$53.37 | PPSC2000-35 | Pantron Right Angle M12 Female Cable | 3-Wire, 35M (114ft) |

ISG-N24 SERIES

ISG-N34 SERIES



AMPLIFIERS

PANTRON SENSOR TECHNOLOGY



| | | | |
|-----------------|----------------------|--|--------|
| \$172.07 | PPSA0124-24 | Pantron ISG-A124 Series Automatic Test Amplifier | 24VAC |
| \$172.07 | PPSA0124-115 | Pantron ISG-A124 Series Automatic Test Amplifier | 115VAC |
| \$172.05 | PPSA0124-230 | Pantron ISG-A124 Series Automatic Test Amplifier | 230VAC |
| \$185.18 | PPSA0124-24DC | Pantron ISG-A124 Series Automatic Test Amplifier | 24VDC |
| \$182.10 | PPSA0134-24 | Pantron ISG-A134 Series Automatic Test Amplifier w/ Time Delay | 24VAC |
| \$182.10 | PPSA0134-115 | Pantron ISG-A134 Series Automatic Test Amplifier w/ Time Delay | 115VAC |
| \$198.29 | PPSA0134-24DC | Pantron ISG-A134 Series Automatic Test Amplifier w/ Time Delay | 24VDC |
| \$125.77 | PPSA0024-24 | Pantron ISG-N24 Series Manual Test Amplifier | 24VAC |
| \$125.76 | PPSA0024-115 | Pantron ISG-N24 Series Manual Test Amplifier | 115VAC |
| \$125.76 | PPSA0024-230 | Pantron ISG-N24 Series Manual Test Amplifier | 230VAC |
| \$141.97 | PPSA0024-24DC | Pantron ISG-N24 Series Manual Test Amplifier | 24VDC |
| \$141.97 | PPSA0034-24 | Pantron ISG-N34 Series Manual Test Amplifier w/ Time Delay | 24VAC |
| \$141.97 | PPSA0034-115 | Pantron ISG-N34 Series Manual Test Amplifier w/ Time Delay | 115VAC |
| \$141.97 | PPSA0034-230 | Pantron ISG-N34 Series Manual Test Amplifier w/ Time Delay | 230VAC |
| \$152.00 | PPSA0034-24DC | Pantron ISG-N34 Series Manual Test Amplifier w/ Time Delay | 24VDC |

MULTIPLEXERS

PANTRON SENSOR TECHNOLOGY



| | | | |
|-----------------|----------------------|--|--------|
| \$389.28 | PPSM4000 | Pantron ISM Series Infrared Photoelectric Multiplexer, 4 Channel | 24VDC |
| \$600.31 | PPSM8000 | Pantron ISM Series Infrared Photoelectric Multiplexer, 8 Channel | 24VDC |
| \$277.77 | PPSM2034-24 | Pantron IMX Series Infrared Photoelectric Multiplexer, 2 Channel | 24VAC |
| \$277.77 | PPSM2034-115 | Pantron IMX Series Infrared Photoelectric Multiplexer, 2 Channel | 115VAC |
| \$282.41 | PPSM2034-24DC | Pantron IMX Series Infrared Photoelectric Multiplexer, 2 Channel | 24VDC |

PPSM4000

PPSM2034-115



PPSP3000

ACCESSORIES

PANTRON SENSOR TECHNOLOGY



| | | |
|----------------|-----------------|---|
| \$11.97 | PPSP3000 | Pantron 11-Pole Amplifier Socket (For Din-Rail Mounting and Retaining Clip) |
| \$12.82 | PPSP3005 | Pantron L-Bracket (for mounting 12mm Photo Eyes) |
| \$72.10 | PPSP3010 | PanBox Protective Enclosure for 1 x single channel, 5" x 5" x 5" |
| \$5.57 | PPSP3015 | Pantron Din Rail, Aluminum, 35mm wide x 10mm high x 4" length (for use w/ PPSP3010) |

ALL PRICES ARE F.O.B. AND ARE SUBJECT TO CHANGE WITHOUT NOTICE • NO C.O.D.'S

1-800-233-3873 • (717) 684-6721 • FAX (800) 446-0495 • KLEENRITE.COM

AUTOMATICS & TUNNELS

SENSORS



BPS1090



BPS1085



BPS1025



BPS5030



BPS1000



BPS1040

PHOTOELECTRIC SENSORS BY BANNER BANNER ENGINEERING



| PRICE | PART # | BANNER # | DESCRIPTION | CONNECTION TYPE |
|----------|---------|-----------------|-------------------------|------------------|
| \$49.95 | BPS1000 | S186E | Banner Emitter | Wire Connection |
| \$70.58 | BPS1005 | S18SP6D | Banner Proximity Switch | Wire Connection |
| \$64.07 | BPS1015 | S18SP6R | Banner Receiver | Wire Connection |
| \$262.79 | BPS1020 | SM30PRLQD | Banner Receiver | Quick Disconnect |
| \$331.18 | BPS1025 | SM2A30PRL | Banner Receiver | Wire Connection |
| \$244.32 | BPS1040 | SMA30PELQD | Banner Emitter | Quick Disconnect |
| \$304.00 | BPS1030 | SMA30PEL W/30 | Banner Emitter | Wire Connection |
| \$290.97 | BPS1035 | SM2A30PRL | Banner Receiver | Wire Connection |
| \$318.17 | BPS1045 | SM2A30PRLW 30' | Banner Receiver | Wire Connection |
| \$233.43 | BPS1085 | QS30ARXQP-74010 | Banner Receiver | Quick Disconnect |
| \$221.51 | BPS1090 | QS30EXQP-74009 | Banner Emitter | Quick Disconnect |
| \$262.74 | BPS1110 | SM30PRL | Banner Receiver | Wire Connection |
| \$244.29 | BPS1115 | SMA30PEL | Banner Emitter | Wire Connection |
| \$188.95 | BPS1120 | QS30RRX | Banner Receiver | Wire Connection |
| \$83.61 | BPS1135 | QS30EQ | Banner Emitter | Quick Disconnect |
| \$106.42 | BPS1140 | QS30RQ | Banner Receiver | Quick Disconnect |
| \$187.85 | BPS1160 | QS30EXQ | Banner Emitter | Quick Disconnect |
| \$188.95 | BPS1165 | QS30ARXQ | Banner Receiver | Quick Disconnect |

CORD SETS BY BANNER

BANNER® ENGINEERING



| PRICE | PART # | BANNER # | DESCRIPTION | CONNECTION TYPE |
|----------|---------------|----------------|---|-----------------------------|
| \$34.75 | BPSC5000 | MQDC1-506 | Banner Cable - 2 Meter, Straight, 5 Pin | Quick Disconnect |
| \$40.17 | BPSC5005 | MQDC1-515 | Banner Cable - 5 Meter, Straight, 5 Pin | Quick Disconnect |
| \$59.72 | BPSC5010 | MQDC1-530 | Banner Cable - 9 Meter, Straight, 5 Pin | Quick Disconnect |
| \$34.75 | BPSC5015 | MQDC1-506RA | Banner Cable - 2 Meter, 90°, 5 Pin | Euro-Style Quick Disconnect |
| \$153.11 | BPSC5020 | MBCC-430 | Banner Cable - 9 Meter, Straight, 4 Pin | Mini-style Quick Disconnect |
| \$153.11 | BPSC5025 | MBCC-330 | Banner Cable - 9 Meter, Straight, 3 Pin | Mini-style Quick Disconnect |
| \$73.84 | BPSC5030 | MBCC-412 | Banner Cable - 4 Meter, Straight, 4 Pin | Mini-style Quick Disconnect |
| \$65.15 | BPSC5040 | SM30CC-306 | Banner Cable - 2 Meter, Straight, 3 Pin | Mini-style Quick Disconnect |
| \$196.55 | BPS1310 | SMICC-350 | Banner Cable - 50' Long, Straight, 3 Pin | Mini-style Quick Disconnect |
| \$228.03 | BPSC5085 | MBCC-460 | Banner Cable - 60' Long, Straight, 4 Pin | Mini-style Quick Disconnect |
| \$40.17 | BPSC5050 | MQDC1-515RA | Banner Cable - 5 Meter, 90°, 5 Pin | Euro-Style Quick Disconnect |
| \$59.72 | BPSC5055 | MQDC1-530RA | Banner Cable - 9 Meter, 90°, 5 Pin | Euro-Style Quick Disconnect |
| \$133.55 | BPSC6000 | MQDC20SS-506 | Banner Cable - 6.5' Long, 5 Pin - Stainless Steel Coupling Nut | Euro-Style Quick Disconnect |
| \$168.32 | BPSC6010 | MQDC20SS-515 | Banner Cable - 15' Long, 5 Pin - Stainless Steel Coupling Nut | Euro-Style Quick Disconnect |
| \$206.32 | BPSC6020 | MQDC20SS-530 | Banner Cable - 30' Long, 5 Pin - Stainless Steel Coupling Nut | Euro-Style Quick Disconnect |
| \$192.21 | BPSC6025 | MQDC20SS-533RA | Banner Cable - 30' Long, 5 Pin, 90° - Stainless Steel Coupling Nut | Euro-Style Quick Disconnect |
| \$45.61 | BPSC6200 | MQDS-WDSS-0406 | Banner Cable - 6.5' Long, 4 Pin - SS Abrasion Resistant | Euro-Style Quick Disconnect |
| \$52.13 | BPSC6205 | MQDS-WDSS-0415 | Banner Cable - 15' Long, 4 Pin - SS Abrasion Resistant | Euro-Style Quick Disconnect |
| \$59.72 | BPSC6210 | MQDS-WDSS-0430 | Banner Cable - 30' Long, 4 Pin - SS Abrasion Resistant | Euro-Style Quick Disconnect |
| \$48.87 | BPSC6215 | MQDS-WDSS-0506 | Banner Cable - 6.5' Long, 5 Pin - SS Abrasion Resistant | Euro-Style Quick Disconnect |
| \$55.39 | BPSC6220 | MQDS-WDSS-0515 | Banner Cable - 15' Long, 5 Pin - SS Abrasion Resistant | Euro-Style Quick Disconnect |
| \$62.98 | BPSC6225 | MQDS-WDSS-0530 | Banner Cable - 30' Long, 5 Pin - SS Abrasion Resistant | Euro-Style Quick Disconnect |
| \$42.35 | BPSC6230-06 | MQDC-606 | Banner Cable - 6.5' Long, 6 Pin Straight - Chrome-plated brass coupling nut | Euro-Style Quick Disconnect |
| \$53.21 | BPSC6230-15 | MQDC-615 | Banner Cable - 15' Long, 6 Pin Straight - Chrome-plated brass coupling nut | Euro-Style Quick Disconnect |
| \$64.61 | BPSC6230 | MQDC-630 | Banner Cable - 30' Long, 6 Pin Straight - Chrome-plated brass coupling nut | Euro-Style Quick Disconnect |
| \$40.18 | BPSC6230-06RA | MQDC-606RA | Banner Cable - 6.5' Long - 6 Pin Right Angle - Chrome-plated brass coupling nut | Euro-Style Quick Disconnect |
| \$53.21 | BPSC6230-15RA | MQDC-615RA | Banner Cable - 15' Long - 6 Pin Right Angle - Chrome-plated brass coupling nut | Euro-Style Quick Disconnect |
| \$62.98 | BPSC6230-30RA | MQDC-630RA | Banner Cable - 30 Long - 6 Pin Right Angle - Chrome-plated brass coupling nut | Euro-Style Quick Disconnect |

AUTOMATICS & TUNNELS

SENSORS

TSMR54251



TLR05CW



RECEIVERS

TELCO SENSORS



| PRICE | PART # | TELCO PART # | DESCRIPTION |
|----------|--------------|----------------|--|
| \$191.07 | SMR5425/1NGK | SMR5425/1NGK | Car wash receiver, M18, NPN, NO/NC, 4P M12 quick disconnect. 3-80ft range. DOES NOT INCLUDE CABLE. |
| \$78.67 | TLR110 | LR110LTB58J-CC | Quick disconnect receiver (sensor only). High powered, thru-beam. M 12 housing. DOES NOT INCLUDE CABLE. |
| \$85.87 | TLR05CW | LR05CW | Car wash receiver, M12, 50ft cable |
| \$89.72 | TLR115 | LR05LCW | Car wash receiver with LED, M12, 50ft cable |

CABLES

TELCO SENSORS



TP80459A



TP80499A

| PRICE | PART # | TELCO PART # | DESCRIPTION |
|---------|--------------|--------------|--|
| \$27.81 | TP80459A | 80459A | 4 Pole, M12 Connector, Straight, 5 Meter, PVC Cable |
| \$41.13 | TP80459A-10M | 80459A-10M | 4 Pole, M12 Connector, Straight, 10 Meter, PVC Cable |
| \$50.51 | TP80459A-15M | 80459A-15M | 4 Pole, M12 Connector, Straight, 15 Meter, PVC Cable |
| \$27.81 | TP80499A | 80499A | 4 Pole, M12 Connector, 90°, 5 Meter, PVC Cable |
| \$50.51 | TP80499A-15M | 80499A-15M | 4 Pole, M12 Connector, 90°, 15 Meter, PVC Cable |

DID YOU KNOW?

Telco amplifiers feature manual sensitivity adjustment, allowing for numerous configurations to suit your needs.

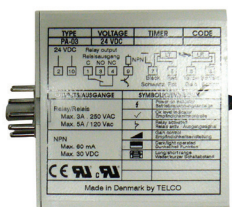

TPPA0324VDC

AMPLIFIERS

TELCO SENSORS



| PRICE | PART # | TELCO PART # | DESCRIPTION |
|----------|-------------|--------------|--|
| \$144.69 | TPA03115VAC | PA03-115VAC | Car Wash Amplifier, 115VAC, Relay/NPN Output |
| \$144.69 | TPA0324VAC | PA03-24VAC | Car Wash Amplifier, 24VAC, Relay/NPN Output |
| \$348.93 | TPA14A903 | TPA14A903 | Test Amplifier 24 VDC |
| \$348.93 | TPA14A902 | TPA14A902 | Test Amplifier 24 VAC |

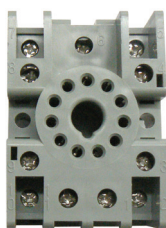

TLR1105



TMPA21B503-05

ACCESSORIES

TELCO SENSORS



| PRICE | PART # | TELCO PART # | DESCRIPTION |
|----------|---------------|--------------|---|
| \$159.52 | TMPA21B503-05 | MPA21B503-05 | Car Wash Multiplexer Amplifier, 24 VDC, 2 Individual Relays |
| \$8.15 | TLR1105 | TR11-05 | Car Wash 11 Pin Socket |

CAR WASH SETS

TELCO SENSORS



- Power ON indicator: Green LED
- Output indicator: Yellow LED
- Operation frequency: 10 Hz
- Response time ON/OFF: 40 ms/40 ms
- Sensing range: 230'

| PRICE | PART # | TELCO PART # | DESCRIPTION |
|----------|----------------|-----------------|---|
| \$292.51 | TPA0324VACSET | PA03-24VAC-SET | Car Wash Set 24VAC With LED, Relay/NPN Output Set Consists of: 1-PA03-24VAC, 1-LR05LCW, 1-LT05LCW, 1-TR11-05 |
| \$292.51 | TPA0324VDCSET | PA03-24VDC-SET | Car Wash Set 24VDC With LED, Relay/NPN Output Set Consists of: 1-PA03-24VDC, 1-LR05LCW, 1-LT05LCW, 1-TR11-05 |
| \$292.51 | TPA03115VACSET | PA03-115VAC-SET | Car Wash Set 115VAC With LED, Relay/NPN Output Set Consists of: 1-PA03-115VAC, 1-LR05LCW, 1-LT05LCW, 1-TR11-05 |



TL5000CNGK-D



TLT05CW

REPLACEMENT PARTS - TRANSMITTERS

TELCO SENSORS



| PRICE | PART # | TELCO PART # | DESCRIPTION |
|----------|--------------|-----------------|--|
| \$143.33 | TL5000CNGK-D | SMT5000CNGK | Car Wash Transmitter, M18, DC, With Control Wire, 4P M12 Quick Disconnect - 3-80ft Range. DOES NOT INCLUDE CABLE. |
| \$55.93 | TLT100 | LT100HLTB58J-CC | Car Wash Transmitter With LED, M12, Hi-Power, 4P M12 Quick Disconnect DOES NOT INCLUDE CABLE. |
| \$57.07 | TLT05CW | LT05CW | Car Wash Transmitter, M12, Hi-Power, 50 FT Cable |
| \$66.53 | TLT115 | LT05LCW | Car Wash Transmitter With LED, M12, Hi-Power, 50 FT Cable |

AUTOMATICS & TUNNELS

SENSORS

AMPLIFIERS

CARLO GAVAZZI

| PRICE | PART # | GAVAZZI PART # | DESCRIPTION |
|-----------------|----------------|----------------|---|
| \$310.00 | CGP1000 | S142ARNN024 | Basic Amplifier 24V AC. NPN & Alarm. |
| \$302.62 | CGP1005 | S142ARNN924 | Basic Amplifier 24V AC/DC. NPN & Alarm. |
| \$14.25 | CGP1020 | ZPD11 | 11 Pin Socket For Amplifiers |



CGP1000

RECEIVERS

CARLO GAVAZZI

| PRICE | PART # | GAVAZZI PART # | DESCRIPTION |
|-----------------|----------------|------------------|--|
| \$145.58 | CGP2000 | MOFR-M12-8 | Receiver - M12 Connection 8° Optical Angle |
| \$145.58 | CGP2005 | MOFR-M14-8 | Receiver - M14 Connection 8° Optical Angle |
| \$194.73 | CGP2010 | MOFR-M14-8-30.5M | Receiver - M12 Connection 8° Optical Angle w/ 100' Cable |



CGP2010

TRANSMITTERS

CARLO GAVAZZI

| PRICE | PART # | GAVAZZI PART # | DESCRIPTION |
|-----------------|----------------|----------------|---|
| \$192.90 | CGP3000 | MOFT20-M12-8 | Transmitter - M12 Connection 8° Optical Angle |
| \$168.80 | CGP3005 | MOFT20-M14-8 | Transmitter - M14 Connection 8° Optical Angle |



CGP2010

MISCELLANEOUS

CARLO GAVAZZI

| PRICE | PART # | GAVAZZI PART # | DESCRIPTION |
|-----------------|----------------|----------------|--|
| \$115.56 | CGP4015 | IA18DSN08NO | Inductive Proximity Sensor. M18 connection. 8mm range. |



CGP4000



IFM0270

IFM EFFECTOR SENSORS

• Quick disconnect cordsets and field wirable connectors offer plug-and-play functionality for electrical wiring.

PRODUCT LINES INCLUDE:

- Female cordsets
- Patch cables
- Y-splitters
- COMBICON connector
- Male cordsets
- Female field wirables
- Male field wirables
- Wiring blocks

| PRICE | PART # | THREAD | SIZE |
|-----------------|----------------|--------|-------|
| \$131.79 | IFM5541 | 12 mm | 2 mm |
| \$128.72 | IFM0270 | 30 mm | 10 mm |
| CALL | IFM7107 | 30 mm | 15 mm |

AUTOMATICS & TUNNELS

TREADLES/SWITCHES

RECORA®

LEADERS IN PRESENCE DETECTION



LOW
MAINTENANCE!
HUNDREDS OF
USES!

ALSO AVAILABLE: RAMP SET - Turn any flat switch into a ramped switch • AM300R • 24" x 5"

AUTO ALERT TREADLE SWITCHES

RECORA

- **AUTOMATIC VEHICLE DETECTORS FOR COMMERCIALS AND INDUSTRIAL USE**
- Ideal for turning equipment on without touching cars
- Rugged enough to work under multi-ton trucks
- Easily wires to lights, horn, bells, or any signaling device
 - Molded to 3/16" steel base plate, 7/8" thick, mounting holes on corners
- Standard sensitivity to 10-15 lbs.
- Standard lead wires are 20' of 18 AWG
- Lead lengths can be up to 150'

| | | | |
|-----------------|---------------|-----------|--------|
| \$117.05 | AM290 | 5" x 17" | Black |
| \$129.42 | AM300 | 5" x 24" | Black |
| \$129.42 | AM300Y | 5" x 24" | Yellow |
| \$142.69 | AM305 | 5" x 32" | Black |
| \$142.69 | AM305Y | 5" x 32" | Yellow |
| \$222.50 | AM295 | 10" x 24" | Black |
| \$222.50 | AM295Y | 10" x 24" | Yellow |

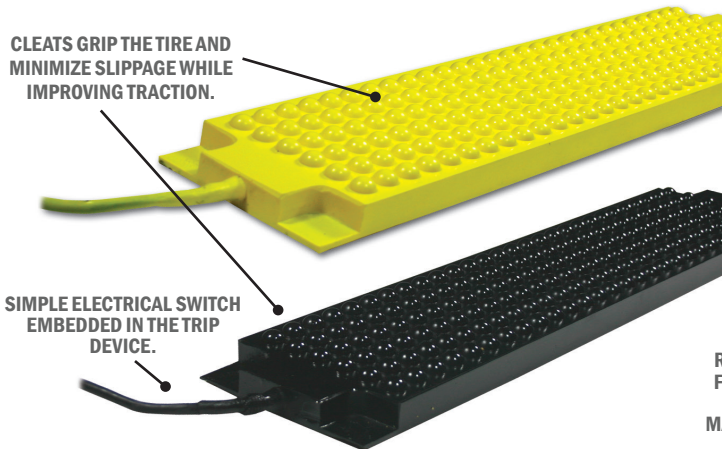

CLEATS GRIP THE TIRE AND MINIMIZE SLIPPAGE WHILE IMPROVING TRACTION.

SIMPLE ELECTRICAL SWITCH EMBEDDED IN THE TRIP DEVICE.

RECESSED, IT PERFORMS ITS FUNCTION WITHOUT GETTING IN THE WAY OF REGULAR MAINTENANCE AND CLEANING.

RECORA®

LEADERS IN PRESENCE DETECTION

TRACTION CONTROL SERIES

RECORA

- Ideal for turning equipment on without touching cars
- Rugged enough to work under multi-ton trucks
- Sensitive enough to respond to the smallest, lightest cars
- Safe, fast, and easy to move in the wash tunnel or on the apron for exact timing control

| | | | |
|-----------------|---------------|----------|--------|
| \$141.15 | AM310Y | 5" x 24" | Yellow |
| \$141.15 | AM310 | 5" x 24" | Black |
| \$154.23 | AM315Y | 5" x 32" | Yellow |
| \$154.23 | AM315 | 5" x 32" | Black |

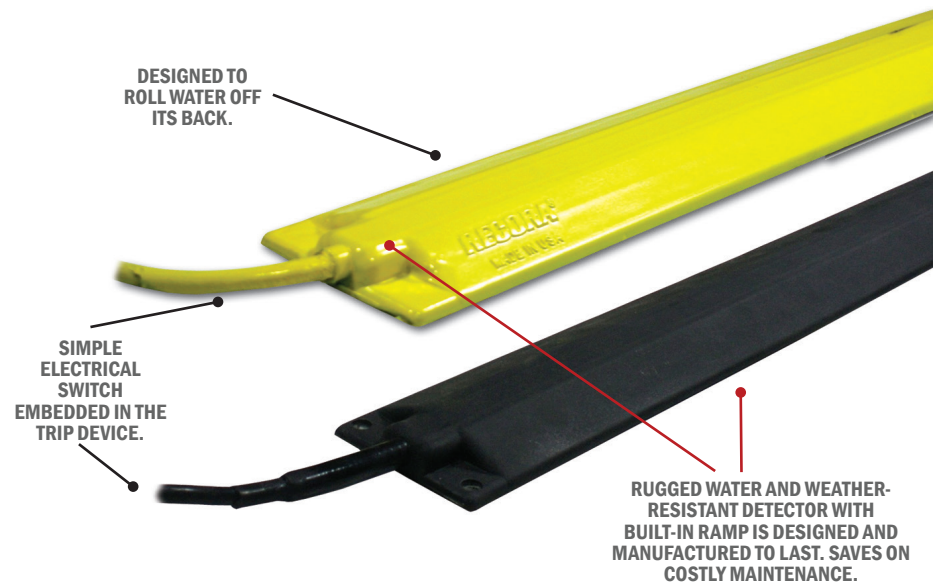

DESIGNED TO ROLL WATER OFF ITS BACK.

SIMPLE ELECTRICAL SWITCH EMBEDDED IN THE TRIP DEVICE.

RUGGED WATER AND WEATHER-RESISTANT DETECTOR WITH BUILT-IN RAMP IS DESIGNED AND MANUFACTURED TO LAST. SAVES ON COSTLY MAINTENANCE.

RECORA®

LEADERS IN PRESENCE DETECTION

N3 SERIES

RECORA

- Provides automatic vehicle detection without frequent maintenance concerns
- Manufactured for reliability
- Able to withstand severe weather conditions
- Extremely effective, yet uncomplicated - perfect for any drive-through wash system where additional systems need to be activated within the wash tunnel

| | | | |
|-----------------|---------------|----------|--------|
| \$134.29 | AM320Y | 3" x 24" | Yellow |
| \$134.29 | AM320 | 3" x 24" | Black |
| \$142.24 | AM325Y | 3" x 32" | Yellow |
| \$142.24 | AM325 | 3" x 32" | Black |

AUTOMATICS & TUNNELS

TREADLES/SWITCHES



24" x 30" CAR WASH MAT SYSTEM TAPESWITCH®



• WHY REPLACE THE COMPLETE MAT WHEN ONLY HALF NEEDS REPLACING?
LESS MONEY, LESS WASTE, LESS SHIPPING COSTS!

TECHNICAL DATA:

- VOLTAGE: 24 VAC or DC
- ACTUATION FORCE: 15 lbs. nominal
- MOUNTING: 6 thru holes on each mat
12 thru holes on a mat system
- CURRENT RATING: 1 AMP
- MATERIAL: Molded PVC
- COLOR: Gray or Yellow



| BLACK MAT SYSTEMS | | |
|-------------------|--------------------|---------------------|
| PRICE | PART # | DESCRIPTION |
| \$560.03 | TSCWRS2430 | Mat System - 2 Mats |
| \$280.01 | TSCWRS2430L | LEFT side mat ONLY |
| \$280.01 | TSCWRS2430R | RIGHT side mat ONLY |

| YELLOW MAT SYSTEMS | | |
|--------------------|----------------------|---------------------|
| PRICE | PART # | DESCRIPTION |
| \$560.03 | TSCWRS2430-Y | Mat System - 2 Mats |
| \$280.01 | TSCWRS2430L-Y | LEFT side mat ONLY |
| \$280.01 | TSCWRS2430R-Y | RIGHT side mat ONLY |

REPLACEMENT FOR 2 POSITION RAMPED FLOOR SWITCH
PART NUMBERS HSP92208, TSCWR2430B AND TSCWR2430A

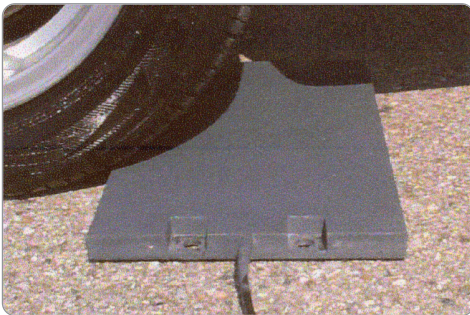

REGULAR SQUARE FLOOR SWITCHES TAPESWITCH



TECHNICAL DATA:

- VOLTAGE: 24 VAC or DC
- ACTUATION FORCE: 15 lbs nominal
- COLOR: Gray
- CURRENT RATING: 1 AMP
- MATERIAL: Molded PVC
- MOUNTING: 4 thru holes on 3/16" steel plate

| PRICE | PART # | SIZE |
|-----------------|----------------|--------------|
| \$107.05 | TSCW517 | 5" W x 17" L |
| \$127.05 | TSCW524 | 5" W x 24" L |
| \$131.76 | TSCW532 | 5" W x 32" L |

| PRICE | PART # | SIZE |
|-----------------|-----------------|---------------|
| \$179.99 | TSCW536 | 5" W x 36" L |
| \$265.96 | TSCW548 | 5" W x 48" L |
| \$203.74 | TSCW1024 | 10" W x 24" L |



RAMPED FLOOR SWITCH TAPESWITCH



TECHNICAL DATA:

- VOLTAGE: 24 VAC or DC
- ACTUATION FORCE: 15 lbs. nominal
- COLOR: Gray
- CURRENT RATING: 1 AMP
- MATERIAL: Molded PVC
- MOUNTING: 4 thru holes on 3/16" steel plate

| PRICE | PART # | SIZE |
|-----------------|-----------------|--------------|
| \$151.28 | TSCW916R | 9" W x 16" L |
| \$168.36 | TSCW924R | 9" W x 24" L |
| \$181.78 | TSCW932R | 9" W x 32" L |
| \$244.00 | TSCW936R | 9" W x 36" L |

| PRICE | PART # | SIZE |
|-----------------|------------------|---------------------|
| \$257.42 | TSCWR1424 | 14" W x 24" L - 24V |



RBMA FLOOR SWITCH TAPESWITCH



| | | | | | |
|-----------------|-----------------|-------|-----------------|-------------------|-----------------|
| \$170.68 | TSRBMA24 | 24" L | \$100.01 | TSRBMA24RS | 24" REPLACEMENT |
| \$194.68 | TSRBMA36 | 36" L | \$116.01 | TSRBMA36RS | 36" REPLACEMENT |

AUTOMATICS & TUNNELS

STERLING MOTORS



MSE3005



MSE3020



MSE3030

MOTORS

STERLING ELECTRIC, INC.

**STERLING
ELECTRIC, INC.**

• Sterling Electric produces a full range of electric motors to meet the most demanding applications found in today's industry. From standard duty applications to the harsh environments of the chemical industry or the washdown requirements of the food processing industry, Sterling Electric has the solution.

| PRICE | PART # | VOLTAGE | HP | PHASE | RPM | ENCLOSURE | MOUNT |
|-------------------|----------------|---------|----|-------|-----------------------|-----------|--|
| \$843.50 | MSE3005 | 230/460 | ½ | 3 | 1800/1760 (full load) | TEFC | C-Face, Footless |
| \$494.99 | MSE3010 | 230/460 | 1½ | 3 | 1800/1765 (full load) | TEFC | C-face supplied with internally locked drive end bearing |
| \$464.99 | MSE3015 | 230/460 | 1 | 3 | 1800/1750 (full load) | TEFC | C-face supplied with internally locked drive end bearing |
| \$499.02 | MSE3020 | 230/460 | ½ | 3 | 1800/1740 (full load) | TENV | C-Face, Footless |
| \$758.12 | MSE3025 | 230/460 | 1 | 3 | 1800/1750 (full load) | TEFC | C-face supplied with internally locked drive end bearing |
| \$1,303.19 | MSE3030 | 230/460 | 1 | 3 | 1800/1750 (full load) | TEFC | C-Face, Footless |

PARKER MOTORS



TC SERIES

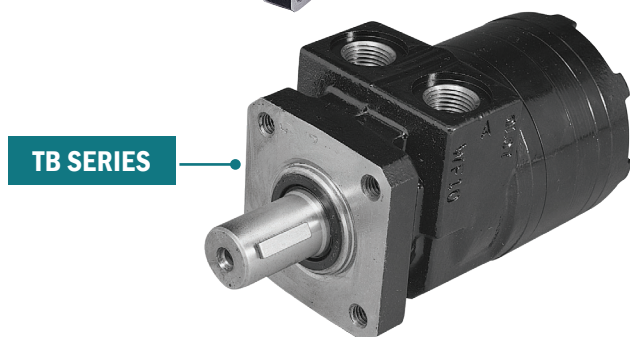

TB SERIES



TE SERIES

TB & TC SERIES MOTORS

PARKER ROSS MOTORS



- Provides low-cost hydraulic power for medium to light duty applications
- Fully interchangeable with industry standards for porting, standard shafts & mountings
- Zero-leak commutation valve provides greater, more consistent, volumetric efficiency
- Full-flow lubrication maximizes cooling & extends motor life up to 50%
- Patented 60-40 spline member arrangement transmits more torque with less weight
- Full interchangeability with other motors - designed according to industry standards
- Unique high-pressure shaft seal - eliminates need for case drains
- Up to 13 HP output

| PRICE | PART # | PARKER NUMBER | DISPLACEMENT | RPM | SHAFT | PORTS | MOUNT |
|-----------------|---------------|-----------------|--------------|-----|-------|---------|--------|
| \$403.06 | PM1115 | TB0195FP100AAAC | 11.9 cu"/rev | 287 | 1" | ½" NPTF | 4 Bolt |
| \$348.25 | PM1150 | TB0050FP100AAAC | 3.0 cu"/rev | 678 | 1" | ½" NPTF | 4 Bolt |
| \$349.45 | PM1155 | TB0065FP100AAAC | 4.0 cu"/rev | 511 | 1" | ½" NPTF | 4 Bolt |
| \$353.85 | PM1175 | TB0100FP100AAAC | 6.0 cu"/rev | 454 | 1" | ½" NPTF | 4 Bolt |
| CALL | PM1185 | TB0165FP100AAAC | 9.9 cu"/rev | 343 | 1" | ½" NPTF | 4 Bolt |
| \$414.71 | PM1195 | TB0230FP100AAAC | 13.9 cu"/rev | 246 | 1" | ½" NPTF | 4 Bolt |
| \$412.26 | PM1225 | TC0050FS100AAAC | 3.0 cu"/rev | 688 | 1" | ⅞" SAE | 4 Bolt |
| \$696.19 | PM1230 | TE0230AS010AAAC | 17.9 cu"/rev | 328 | 1" | ⅞" SAE | 2 Bolt |

TORQMOTOR TE SERIES

PARKER ROSS MOTORS



- Reliable performance for light duty applications at your wash facility. Durable construction with continuous oil flow for extended service life and great side load capacity and smooth, hassle-free operation. Unique design eliminates the need of a case drain.
- 1" Keyed • Mounting: 4 Bolt w/ ⅜"-16 UNC • Ports: ⅞"-14 SAE

| PRICE | PART # | PARKER NUMBER | DISPLACEMENT | RPM | LENGTH |
|-----------------|---------------|-----------------|--------------|------|-------------------|
| \$634.01 | PM1255 | TE0195FS100AAC | 4 cu"/rev | 292 | 140 mm (5.51") |
| \$348.25 | PM1150 | TB0050FP100AAAC | 11.9 cu"/rev | 1020 | 165.42 mm (6.51") |

FEATURED PRODUCT

CHAR-LYNN MOTORS



Char-Lynn designs each motor for optimum performance. Each LSHT motor provides high-torque strength without the stress of fast-moving parts that can cause damage. They are excellent for conveyors that need power to move objects yet do not need to operate at a quick pace.

LOW SPEED

Motor start-up speed causes a spike in energy usage. Char-Lynn's low-speed design provides smooth operation at all times, from start-up to shut-down, to extend the life of the motor.

HIGH TORQUE

Char-Lynn hydraulic motors transform fluid energy into mechanical power. Power is the result of speed and torque, and high torque is required to start a load moving.

COMPACT & COST-EFFECTIVE

The LSHT motor eliminates the gearbox to save space and lower costs! Only 3 primary components are needed to transmit torque through the motor: starter, drive, and output shaft.

REVERSIBLE DESIGN

These motors let you reverse the direction of hydraulic fluid flow, without losing torque! Plus, the motors mount directly to the driven device.

GENERAL PURPOSE MOTORS

When choosing your motor, consider the following motor specs: pressure range, speed, torque, and fluid compatibility. You can shop for many popular models from the Char-Lynn H Series and S Series at Kleen-Rite.

H SERIES MOTOR

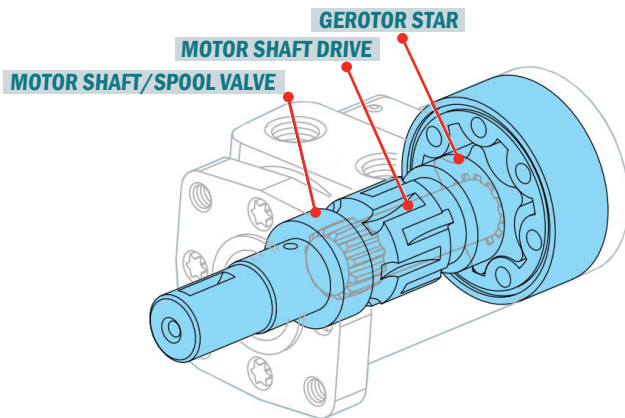

- Economical and compact
- Designed for medium duty applications.
- Features an industry-proven spool valve design with state-of-the-art gerotors
- Geroters offer fluid-tight sealing for leak-free performance. Great for conveyors and car wash brushes!
- Equipment can be driven direct to save costs

S SERIES MOTOR

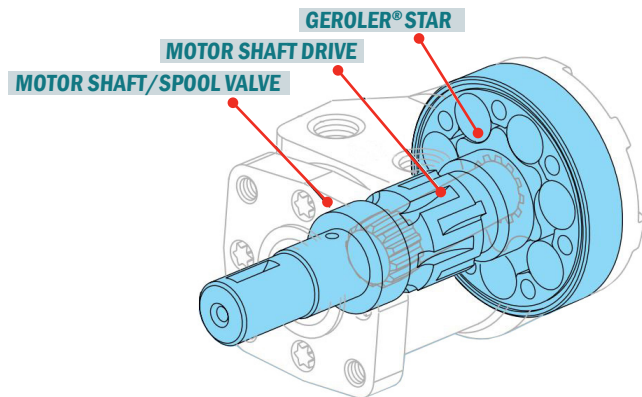

- An S Series motor with a Geroler has a compact size and an optimized drive running angle to improve mechanical efficiency
- Within the Geroler, rollers provide support as the starter rotates. This minimizes friction and promotes efficiency, especially at start-up and low speeds
- Leak-free performance and smooth operation

FEATURED PRODUCT

CHAR-LYNN® MOTORS

H SERIES MOTOR

CHAR-LYNN MOTORS

- **MAXIMUM CASE PRESSURE:** 1500 PSI
- **MAXIMUM RECOMMENDED OPERATING TEMPERATURE:** 180°F
- **FLUID VISCOSITY:** Minimum viscosity at operating temperature should be the highest of the following:
10 SUS or (20 x PSI)/RPM=SUS
- **RECOMMENDED FLUIDS:** Premium quality, anti-wear type hydraulic fluid
- **RECOMMENDED FILTRATION:** Per ISO Cleanliness Code Level 18/13
- **RECOMMENDED BREAK-IN:** To assure best motor life, run motor for approximately one hour at 30% of rated pressure before application to full load. Be sure motor is filled with fluid prior to any load applications



CLP22000-2



CLP14193

| PRICE | PART# | DESCRIPTION | DISPLACEMENT | RPM/3 GPM | RPM/6 GPM | RING SIZE | |
|----------|----------------|-----------------------------|--------------|-----------|-----------|-----------|--|
| \$277.81 | CL101-1001-009 | Motor, 1/4" Ring | 2.8 | 235 | 471 | 1/4" | |
| \$285.48 | CL101-1002-009 | Motor, 3/8" Ring | 4.5 | 150 | 296 | 3/8" | |
| \$293.92 | CL101-1003-009 | Motor, 1/2" Ring | 5.9 | 115 | 230 | 1/2" | |
| \$341.77 | CL101-1004-009 | Motor, 7/8" Ring | 9.7 | 70 | 140 | 7/8" | |
| \$354.55 | CL101-1005-009 | Motor, 1" Ring | 11.3 | 60 | 120 | 1" | |
| \$349.18 | CL101-1006-009 | Motor, 1 1/4" Ring | 14.1 | 48 | 95 | 1 1/4" | |
| \$369.15 | CL101-1007-009 | Motor, 1 1/2" Ring | 17.9 | 38 | 75 | 1 1/2" | |
| \$403.67 | CL101-1008-009 | Motor 2" Ring | 22.6 | 30 | 60 | 2" | |
| \$95.75 | CLP22000-2 | 4 Bolt Mount Flange 009-010 | | | | | |
| CALL | CLP7464 | 4 Bolt Mount Flange 007-008 | | | | | |
| \$117.49 | CLP22000-1 | 2 Bolt Mount Flange 009-010 | | | | | |
| \$66.31 | CLP60540 | Seal Kit 009 | | | | | |
| \$58.68 | CLP60023 | Seal Kit 007 | | | | | |
| \$4.08 | CLP14193 | Woodruff Key, 1" | | | | | |

S-PLUS MOTOR

CHAR-LYNN MOTORS

- **MAXIMUM RECOMMENDED OPERATING TEMP.:** 180°F
- **MAXIMUM CASE PRESSURE:** 1500 PSI
- **RECOMMENDED BREAK-IN:** To assure best motor life, run motor for approximately one hour at 30% of rated pressure before application to full load. Be sure motor is filled with fluid prior to any load applications
- **FLUID VISCOSITY:** 70 SUS at operating temperature
- **RECOMMENDED FLUIDS:** Premium quality, anti-wear type hydraulic fluid
- **RECOMMENDED FILTRATION:** Per ISO Cleanliness Code Level 18/13



CLP60539

| PRICE | PART# | DESCRIPTION | DISPLACEMENT | RPM/3 GPM | RPM/6 GPM | RING SIZE | |
|----------|----------------|-----------------------------|--------------|-----------|-----------|-----------|--|
| \$418.29 | CL103-1002-012 | Motor, 3/8" Ring | 4.5 | 146 | 293 | 3/8" | |
| \$423.64 | CL103-1003-012 | Motor, 1/2" Ring | 5.9 | 112 | 225 | 1/2" | |
| \$448.21 | CL103-1004-012 | Motor, 7/8" Ring | 9.7 | 68 | 136 | 7/8" | |
| \$459.71 | CL103-1005-012 | Motor, 1" Ring | 11.3 | 58 | 117 | 1" | |
| \$480.44 | CL103-1006-012 | Motor, 1 1/4" Ring | 14.1 | 47 | 95 | 1 1/4" | |
| CALL | CL103-1007-012 | Motor, 1 1/2" Ring | 17.9 | 37 | 75 | 1 1/2" | |
| \$539.52 | CL103-1008-012 | Motor, 2" Ring | 22.6 | 30 | 60 | 2" | |
| \$95.75 | CLP22000-2 | 4 Bolt Mount Flange 009-010 | | | | | |
| \$117.49 | CLP22000-1 | 2 Bolt Mount Flange 009-010 | | | | | |
| \$69.40 | CLP60539 | Seal Kit 010 | | | | | |
| \$56.45 | CLP60533 | Seal Kit 008 | | | | | |

WHEEL MOTORS CENTER FLANGE 10,000 SERIES

CHAR-LYNN MOTORS

| PRICE | PART# | DESCRIPTION |
|------------|----------------|----------------------|
| \$3,809.88 | CL120-1008-003 | Motor, 10,000 Series |
| \$68.48 | CLP6405 | Motor Seal Kit |
| \$71.94 | CLP6406 | Shaft Seal Kit |

2000 SERIES

CHAR-LYNN MOTORS

- 1 1/4" Keyed Shaft

| PRICE | PART# | DESCRIPTION |
|----------|----------------|----------------------|
| \$738.83 | CL104-1043-006 | Motor, 18.7 cu"/ Rev |
| \$691.23 | CL104-1025-006 | Motor, 9.6 cu"/ Rev |
| \$95.54 | CLP61258 | Seal Kit 104 & 106 |

FRONT FLANGE - 10,000 SERIES

CHAR-LYNN MOTORS

- 2 1/4" Shaft • 54.7 Cubic Inch Displacement

| | |
|------------|----------------|
| \$3,591.99 | CL119-1031-003 |
|------------|----------------|

2000 SERIES

CHAR-LYNN MOTORS

| PRICE | PART# | DESCRIPTION |
|----------|----------------|----------------------|
| \$617.13 | CL106-1012-006 | Motor, 11.9 cu"/ Rev |
| \$638.14 | CL106-1013-006 | Motor, 14.9 cu"/ Rev |
| \$656.86 | CL106-1014-006 | Motor, 18.7 cu"/ Rev |
| \$686.22 | CL106-1015-006 | Motor, 24 cu"/ Rev |
| \$95.54 | CLP61258 | Seal Kit 104 & 106 |
| \$46.52 | CLP61259 | Buna Seal Kit |

AUTOMATICS & TUNNELS

LUBRICANTS, SEALANTS & ANTI-SEIZE



CARTRIDGE



AEROSOL



CANISTER



OILER

SUPER LUBE® AUTOMATICS SUPPLIES

- "EVERYWHERE AND NO WEAR!"
- Super Lube lasts longer and outperforms conventional petroleum-based greases and oils. It comes in grease form, a 90-140 weight gear oil and 10W light-weight oil.

| PRICE | PART # | DESCRIPTION |
|---------|---------|------------------------------|
| \$11.06 | SL11016 | Dri-Film Aerosol |
| \$6.67 | SL21030 | 3 oz. Grease |
| \$7.52 | SL21036 | 3 oz. Cartridge of Grease |
| \$8.58 | SL31040 | 6 oz. Aerosol |
| \$9.89 | SL31110 | 11 oz. Aerosol |
| \$14.54 | SL41150 | 400 gram Cartridge of Grease |
| \$4.68 | SL51010 | 7 ml Precision Oiler |



JL47102



JL35050



JL33050

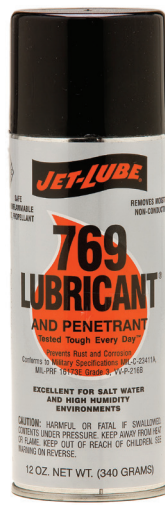

JL37341



JL34041



JL73560



JL32460

JET LUBE® ANTI-SEIZE, SEALANTS & LUBRICATIONS AUTOMATICS SUPPLIES

| | | |
|---------|---------|--|
| \$24.87 | JL47102 | 550 EXTREME ANTI-SEIZE LUBRICANT WITH BRUSH TOP 1 LB. - Enhanced rust and corrosion resistance. Lead free. Protects against seizure, heat-freeze, galling, rut and corrosion. Lowers friction, reduces wrench torque. Provides easy makeup and breakout. Reduces maintenance costs. Not affected by contraction, expansion, or vibration. |
| \$12.19 | JL35050 | ARCTIC LOW-TEMPERATURE GREASE CARTRIDGE 14 OZ. - Designed for extreme cold weather environments where fluid film strength is important and grease consistency remains the same. It is ideally suited for applications that experience working environments at subzero climates. |
| \$14.38 | JL33050 | 202 MOLY-LITH MULTI-PURPOSE GREASE CARTRIDGE 14 OZ. - Excellent for rack/pinion grease cups, drive shaft idler arm and ball joints. Specifically formulated to protect your equipment from premature damages that can occur from dirt, dust, and sediments. |
| \$15.63 | JL37341 | 769 LUBRICANT AEROSOL 12 OZ. - unique in that it lifts and displaces moisture, rather than trapping it. Pores and crevices of surfaces are freed from moisture and are coated with a thin non-greasy film that prevents additional moisture from clinging or entering. |
| \$16.52 | JL34041 | WRL WIRE ROPE & CHAIN LUBRICANT AEROSOL 12 OZ. - quickly penetrates wire rope and cable to the core and builds a shield against offshore weathering conditions. It's highly resistant to rain and salt water atmospheres and is a water displacing spray and lubricant. |
| \$27.78 | JL73560 | SILICONE COMPOUND DM 5 OZ. - Dielectric, translucent paste that provides excellent lubrication and sealing properties for plug and gate valves, stuffing boxes, o-rings, vacuum and pressure systems. |
| \$25.23 | JL32460 | 5.30Z MP SILICONE GREASE - Designed compatibility for O-ring materials including Buna-N, Viton, HSN, Teflon, nitrile, and nylon. Ideally suited as an insulator for electrical connectors against the elements. |

AUTOMATICS & TUNNELS

CAR WASH TANKS



SINGLE FUNCTION WALL MOUNT PANEL FOR AUTOMATICS

AIR LOGIC

- 14" x 32" Stainless Steel Wall Mount Panel
- (1) Stainless Steel Tank
- (1) Santo FloJet Pump
- (1) 506 Hydrominder
- (1) Air Regulator / Gauge

CALL

LPS1AUTO



TRIPLE FOAM WALL MOUNT PANEL FOR AUTOMATICS

AIR LOGIC

- (2) Stainless Steel Wall Mount Panels
- (3) Stainless Steel Tanks
- (3) Santo FloJet Pumps
- (3) 506 Hydrominders
- Pre-plumbed & wired with solenoids and regulators

\$2,139.13

LPS3AUTO



DOUBLE FUNCTION WALL MOUNT PANEL FOR AUTOMATICS

AIR LOGIC

- 14" x 32" Stainless Steel Wall Mount Panel
- (2) Stainless Steel Tanks
- (2) Santo FloJet Pumps
- (2) 506 Hydrominders
- (2) Air Regulator / Gauges

CALL

LPS2AUTO

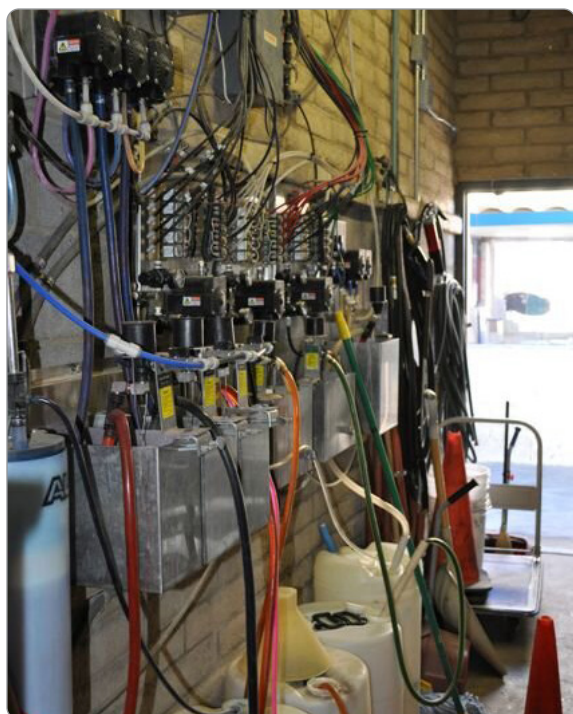

<https://airlogiccarwash.com/>



TA0130 24" x 24" x 12"



TA0224 12" x 6" x 10"

STAINLESS STEEL WALL TANK

MOUNTED TANKS

- Available in single, double, & triple • 3/4" outlet fitting
- Wall mounting brackets attached to tank
- SHOWN WITH BRACKET, ALL PARTS SOLD SEPARATELY

| | | |
|----------|---------|---------------------------|
| \$419.89 | TA0160 | Single Tank |
| \$527.91 | TA0110 | Double Tank |
| \$652.05 | TA0130 | Triple Tank |
| \$177.58 | TA0224 | Stainless Steel Wall Tank |
| \$46.69 | TA0224B | Stainless Steel Bracket |
| \$29.74 | TA0224L | Lid Only for Tank |

AUTOMATICS & TUNNELS

FOAM GENERATORS



EASY CLEAN CAR WASH FOAM GENERATOR

NEW WAVE INNOVATIONS, INC.



- The easy clean generator is a revolutionary foam generator that takes the trouble out of cleaning your chemical application foam generators - no tools needed since there are no fittings to take apart or any air and chemical lines to disconnect!
- The media is made up of two types: one that mixes and one that foams
- No need for the needle valve or check valves because the media is suspended to the twist off cap so that the media does not compress in the foam chambers, creating unpredictable back-pressure and flow resistance
- Installation is a snap - each unit comes with direct fit air and chemical fittings and outlet sizes to fit your applicators
- Cleans in seconds, not minutes
- Uses less chemical to create a dramatic show of foam, color and scent that your customers will love and come back for over and over again!
- Reduce expenses in labor, water and chemicals!

GENERATOR

INSERT

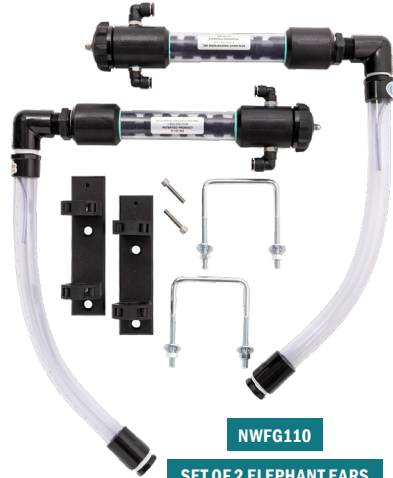

NWFG110

SET OF 2 ELEPHANT EARS

10" BAY FOAM GENERATOR FOR SELF SERVE BAYS

NEW WAVE INNOVATIONS, INC.



COMES STANDARD WITH:

- 3/4" female output fitting
- 3/8" air push lock fitting
- 1/2" chemical push lock fitting
- 4" square mount

| | | |
|-----------------|------------------|-------------------------------|
| \$101.49 | NWFG105 | 10" Foam Generator |
| \$42.49 | NWFG105-I | Insert for 10" Foam Generator |

16" EASY CLEAN GENERATOR FOR TUNNEL APPLICATIONS

NEW WAVE INNOVATIONS, INC.



COMES STANDARD WITH:

- 1" male output fitting
- 3/8" air push lock fitting
- 1/2" chemical push lock fitting

| | | |
|-----------------|------------------|-------------------------------|
| \$173.41 | NWFG100 | 16" Foam Generator |
| \$41.62 | NWFG100-I | Insert for 16" Foam Generator |

ELEPHANT EAR FOAMER PARTS & ACCESSORIES

NEW WAVE INNOVATIONS, INC.



| | | |
|-----------------|----------------|--------------------------------|
| \$49.47 | NWFG-M | Mount for Foam Generator |
| \$371.41 | NWFG110 | Elephant Ear Foamer (Set of 2) |
| \$310.60 | NWFG115 | Single Elephant Ear Foamer |

| | | |
|-----------------|-------------------|--------------------------------------|
| \$100.02 | NWFG110-FT | Foam tube for Elephant Ear Foamer |
| \$37.31 | NWFG110-MK | Mounting Kit for Elephant Ear Foamer |

TOP STICK TRIPLE SET WITH GENERATORS AND MOUNTING

NEW WAVE INNOVATIONS, INC.



- Triple top stick foamer kit for tunnel car washes. Molded design for improved dispensing, provides consistent performance out of a compact design that offers great clearance for vehicles. Delivers broad coverage for even the widest trucks and SUVs.
- Includes: 3 stick foamers, generators, and mounting kit for easy installation

| | |
|-----------------|------------------|
| \$977.32 | NWFG120-3 |
|-----------------|------------------|

CYCLONE 1-3 COLOR RAIN ROPE RIBBON APPLICATOR

NEW WAVE INNOVATIONS, INC.



- Creates rope-like droplets onto the vehicle for a great show! Mounting system allows for the mounting of additional applicators or lights in conjunction with the Cyclone for a comprehensive, easy-to-service unit that can be added and removed as needed
- Mount vertically or horizontally
- Mix & match - dispense up to six different colors of product! | Use with presoak, wax, and more!

| | |
|-------------------|----------------|
| \$1,239.33 | CYCLONE |
|-------------------|----------------|

FLAT MOUNT BOOMERANG FOAMING UNITS

TSS



- Effective and flexible foamer made out of chemical resistant HDPE and stainless steel bolts
- Flat mounting base facilitates easy installation anywhere you see fit within your wash area
- Features foam generators that optimize chemical performance and consistency by using two types of foaming media

SPECIFICATIONS:

- 3/8" Air Intake | 1/2" Solution Intake | Minimum Flow Rate of 6 GPM @ 40 PSI | Built-in Check Valve

| | | |
|-------------------|----------------|--|
| \$609.67 | TSSBFB2 | Single set of two boomerang foamers (two units total) |
| \$1,615.38 | TSSBFB3 | Triple set of boomerang foamer units (six units total) |

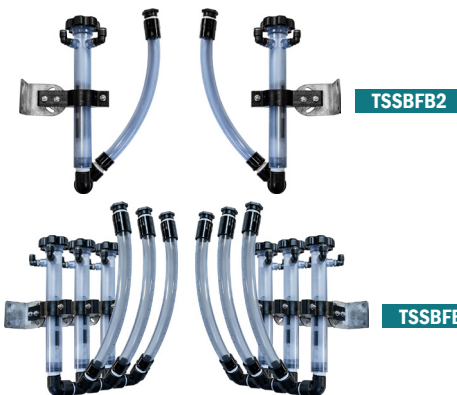

TSSBFB2

TSSBFB3

AUTOMATICS & TUNNELS

VALVES & AIR CYLINDERS



LEXAIR AIR OPERATED SHUT OFF VALVE & REPAIR KIT LEXAIR, INC.



- For use in high pressure lines and change over between spray arch and underbody on PDQ LaserWash 4000
- 1" FPT port connection | Pressure rating 1000 PSI | Direct pilot operated normally open valve
- Valves feature a large resilient poppet that provides bubble-tight closure, even under low pressure conditions
- Internal components made from bronze, brass and stainless steel
- Pilot cap is easily removed for quick access to the valve's one-piece poppet assembly
- O-ring on poppet and U-cup pilot piston seal prevent controlled and pilot media from mixing permitting use of different media for pilot/control
- Incorporate a single, direct operated poppet design

| | | |
|-----------------|------------------|------------|
| \$485.19 | LX4136202 | Valve |
| \$139.71 | LX4136002 | Repair Kit |



DANFOSS VALVES DANFOSS



- Direct servo-operated 2/2-way solenoid valve.
- **CALL OR VISIT OUR VALVES & SWIVELS SECTION FOR MORE OPTIONS!**

3/8 SOLENOID VALVE (LESS COIL) DANFOSS

| | | |
|----------------|----------------|----------------|
| \$64.90 | DF06LC | For Type EVS16 |
| \$23.93 | DF06LCK | Repair Kit |

1/2 SOLENOID VALVE (LESS COIL) DANFOSS

| | |
|----------------|---------------|
| \$53.40 | DF08LC |
|----------------|---------------|

NFPA AIR CYLINDERS

IR ARO



- **NO CORROSION - IDEAL FOR CAR WASH APPLICATIONS**
- Tie bolt construction eliminates rod binding and tie rod torque problems
- Rugged thick walled tubes resist denting.
- NFPA repairable and interchangeable.
- Factory lubricated grease that will not wash out.
- Operates on air pressure up to 250 psi
- Output forces up to 19,635 lbs. (10" bore at 250 psi).
- Std. operating temp: 0 degrees to 185°F, -18° to 82°C).
- Viton seals for high heat applications (up to 300°F, 149°C)

| PRICE | PART | ARO MODEL | DESCRIPTION | SPECS. |
|-----------------|---------------|-----------------|---------------------------|-----------------------------|
| \$199.81 | AC1040 | ANAQK-ABXAD-080 | ARO CLEVIS Mount Cylinder | 1 1/2" Bore X 8" Stroke |
| \$259.14 | AC1050 | ANAQK-ABXAD-120 | ARO CLEVIS Mount Cylinder | 1 1/2" Bore X 12" Stroke |
| \$147.75 | AC1060 | ANAQK-CBXAC-044 | ARO CLEVIS Mount Cylinder | 1 1/2" Bore X 4 1/2" Stroke |

SIMONIZ® PAD PERFECT™ REPLACEMENT PARTS



SIMONIZ® PAD PERFECT™ SIMONIZ AUTOMATICS



| | | |
|-------------------|----------------|---------------------------------------|
| \$192.98 | PA5220 | Pad Perfect 5 Gallons |
| \$1,116.20 | DR30264 | 30 Gallons |
| \$1,858.04 | DR55264 | 55 Gallons |
| \$279.03 | SMTS200 | C-Style Concave Pads/Rails Set of 4 |

AUTOMATICS & TUNNELS

LOOP DETECTORS & ACCESSORIES



SP-24 SURFACE MOUNTED LOOP PAD

EMX INDUSTRIES, INC.



- The SP-24 Surface Mounted Loop Pad is designed for use with EMX loop detectors
- Size: 23³/₄" x 23³/₄" x 1"
- Material: black polypropylene
- Lead-In: 50 feet shielded twisted pair
- SP-24 Lead-In Guard: 24" x 3" x 1/2" and also made out of black polypropylene

| | | |
|-----------------|-------------------|-----------------------|
| \$574.45 | EMSP24 | Loop Pad |
| \$607.83 | EMSP24-100 | Loop Pad W/ 100' Lead |

PREFORMED LOOP

EMX INDUSTRIES, INC.

- With 50' lead

| | | |
|-----------------|---------------|---------|
| \$153.94 | EMPR26 | 2' x 6' |
| \$149.64 | DMLOOP | 4' x 6' |
| \$161.57 | EMPR48 | 4' x 8' |



11 PIN HARNESS

EMX INDUSTRIES, INC.

- With 3' of wire

| | |
|----------------|----------------|
| \$12.71 | EMHAR11 |
|----------------|----------------|

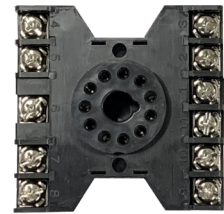

11 PIN SOCKET

EMX INDUSTRIES, INC.

- Base for DIN rail mount

| | |
|----------------|---------------|
| \$11.44 | EMBASE |
|----------------|---------------|



LOOP-LESS ULTRASONIC VEHICLE DETECTOR

EMX INDUSTRIES, INC.



- Installs easily above ground - just aim to detect
- 4 ultrasonic sensing elements
- Operating range: 1' to 5'
- 2 relay output
- Ideal for fast food, parking, banking, pharmacy, and carwash drive-thru operations

| | |
|-----------------|------------------|
| \$267.30 | EMUSVD-4X |
|-----------------|------------------|



ULTRALOOP MULTI-VOLTAGE VEHICLE DETECTOR

EMX INDUSTRIES, INC.



- Universal input range: 12 VDC to 240 VAC
- Small size: 73 x 38 x 78mm
- 10 sensitivity adjustments
- 4 frequency settings
- ULTRAMETER display indicates the appropriate sensitivity setting for vehicle on loop
- DETECT-ON-STOP technology distinguishes between moving and stopped vehicles

| | |
|-----------------|----------------------|
| \$151.88 | EMDTEK-ULTMVP |
|-----------------|----------------------|



MULTI-VOLTAGE VEHICLE DETECTOR

EMX INDUSTRIES, INC.

- Universal Input Range: 12V to 240V AC/DC
- Loop diagnostics, isolation transformer, conditioner
- Aluminum RF shield housing
- Loop frequency counter
- 10 gold plated sensitivity controls
- 8 gold plated function controls
- 6 gold plated controls for frequency, reset & counter
- 2 High intensity LED indicators
- 2 relays pulse or presence

| | |
|-----------------|-------------------|
| \$110.76 | EMDTEK-MVP |
|-----------------|-------------------|



LOW POWER VEHICLE DETECTOR

EMX INDUSTRIES, INC.

- 2 relays
- LED indicators
- Requires 12-24V AC/DC power supply
- Only draws up to 9 mA current
- 3, 6, and 9 second extend direct output controls
- Fail safe detection modes
- Surge protection and loop isolation transformer
- Loop diagnostics and built-in loop conditioner
- Extruded anodized aluminum RF shield housing
- Frequency counter
- Circular 11 pin connector
- 4 minute limit control

| | |
|-----------------|------------------|
| \$103.57 | EMDTEK-LP |
|-----------------|------------------|

AUTOMATICS & TUNNELS

LOOP DETECTORS & ACCESSORIES

New! **FLAT PACK VEHICLE SENSOR**
EMX INDUSTRIES, INC.



- Housing: Polyamide
- Outputs: NPN - open collector
- Connection: 5 conductor
- Operating environment: -40° F..180° F)
0...95% relative humidity
- Environmental rating: IP69K
- Power supply: 12-30 VDC
- Current draw: 10 mA max
- Dimensions: 4.3" x .9" x .3"
- 50' long lead
- Use with the LRS-C1 Controller
- Purchase as a kit that includes both the sensor and controller (part #LRS-FP-50-K)
- Direct Burial Sensor also available (part #LRS-DB-50)

\$153.75 LRS-FP-50

New! **DIRECT BURIAL VEHICLE SENSOR FOR LRS**
EMX INDUSTRIES, INC.



- Housing: PVC
- Outputs: NPN - open collector
- Connection: 5 conductor
- Environmental rating: IP69K
- Power supply: 12-30 VDC
- Current draw: 10 mA max
- Dimensions: 4" x 1"
- 50' long lead
- Use with the LRS-C1 Controller
- Purchase as a kit that includes both the sensor and controller (part #LRS-DB-50-K)
- Flat Pack Sensor also available (part #LRS-FP-50)

\$162.55 LRS-DB-50

New! **LOGIC CONTROLLER FOR LRS**
EMX INDUSTRIES, INC.



- Power indicator: Green LED
- Detect indicator: 2 Red LEDs
- Configuration selector: 10 position rotary switch
- Dimensions: 2.9" x 1.2" x 3.1"
- Connector: 11 pin male connector (JEDEC B11-88)
- Two relay operation
- A/B directional logic
- Pulse on entry and on exit
- Relay 1 only

\$113.36 LRS-LC

New! **CONTROLLER FOR LOOP REPLACEMENT SYSTEM (LRS)**
EMX INDUSTRIES, INC.



- Housing: ABS plastic
- Dimensions: 3" x .9" x 2.75"
- Outputs: SPDT relay
- Power: 12-30 VDC and 24 VAC
- Output current rating relay: 1 A @ 24-120 VDC
- Current draw: 40 mA (max)
- Supply protection: Reverse polarity and fuse protected
- Use with the Flat Pack Sensor (part #LRS-FP-50) or Direct Burial Sensor (part #LRS-DB-50)
- Available as kits that include a controller and sensor (LRS-FP-50-K or LRS-DB-50-K)

\$107.66 LRS-C1

New! **OVERHEAD MICROWAVE MOTION SENSOR HUMAN/VEHICLE DISCRIMINATION**
EMX INDUSTRIES, INC.



- Operating frequency: 24.150 GHz
- Detection range: Maximum detection range of 23' x 23' at an installation height of 16', and a housing angle of 45° (dependent on sensor height and housing angle)
- Mounting height: 8-23 ft (2.5-7 m)
- Power: 12-36 VDC or 12-28 VAC
- Dimensions: With bracket - 5.16" x 2.87" x 5.35"
- Connection: 26' (8m) cable

\$378.57 RAVEN

New! **(LRS) VEHICLE DETECTION KIT-CONTROLLER AND FLAT PACK SENSOR**
EMX INDUSTRIES, INC.



- Sensing technology: 3-axis magnetoresistive
- ULTRAMETER display: 10 levels of sensitivity: 0-9
- Axis sensitivity: 512 counts/gauss (typical)
- Detect-on-step: Requires vehicle to stop for a minimum of 1 second (1-2s typical)
- Power supply: 12-30 VDC and 24 VAC (controller), 12-30 VDC (sensor)
- DETECT-ON-STOP™ (DOS®) feature will allow detection only when a vehicle has come to a complete stop near the sensor. This EMX exclusive technology ignores cross traffic in tight spaces
- Flat Pack Sensor (part #LRS-FP-50) and LRS Controller (part #LRS-C1) available separately
- Dimensions: 3" x .9" x 2.75" (controller), 4.3" x .9" x .3" (sensor)

\$263.74 LRS-FP-50-K

New! **(LRS) VEHICLE DETECTION KIT-CONTROLLER AND DIRECT BURIAL SENSOR**
EMX INDUSTRIES, INC.



- Sensing technology: 3-axis magnetoresistive
- ULTRAMETER display: 10 levels of sensitivity: 0-9
- Axis sensitivity: 512 counts/gauss (typical)
- Power supply: 12-30 VDC and 24 VAC (controller), 12-30 VDC (sensor)
- Control module for programming and relay contact output
- Stand-alone sensor stores background and settings in a non-volatile memory
- DETECT-ON-STOP™ (DOS®) feature will allow detection only when a vehicle has come to a complete stop near the sensor. This EMX exclusive technology ignores cross traffic in tight spaces
- Direct Burial Sensor (part #LRS-DB-50) and LRS Controller (part #LRS-C1) available separately
- Dimensions: 3" x .9" x 2.75" (controller), 4" x 1" (sensor)

\$271.49 LRS-DB-50-K

AUTOMATICS & TUNNELS

UNDERCARRIAGE & TIRE CLEANERS

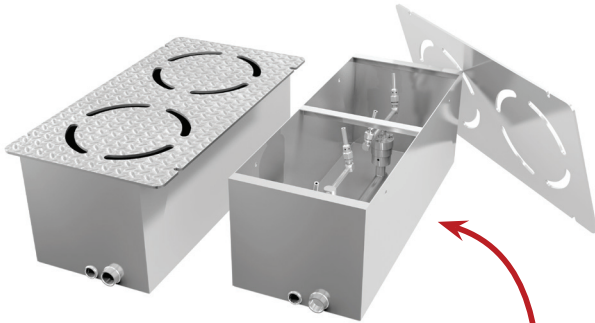

STATIONARY UNDERCARRIAGE CLEANER

MOSMATIC



- The TUW stationary is perfect for fixed ramp over or sub-floor undercarriage wash systems. Industrial grade stainless steel plates and boxes come complete with quad bearing swivels and welded balanced rotor arms. The high lift design removes heavy debris and cleans without damage to the vehicles undercarriage
- Compact solid construction • Equipped with nozzle stabilizers
- Modular Design • Requires 4x EG-nozzles, according to your pump specifications
- **PRESSURE:** 4000 PSI • **MAX. TEMP:** 250°F
- **MAX. RPM:** 2000 • **WATER CONNECTION:** 3/4" NPTF
- **WATER DRAIN:** 1" NPTF • **THROUGHPUT MEDIUM:** pH 3-12
- **SWIVEL:** 2x DYT • **ROTOR ARM:** 8"/10"
- **STAB. NOZZLE/ADAPTER:** 4x 14.901 • **DIMENSIONS:** 29½" x 11.8" x 10.8"
- **WEIGHT:** 70.5 lbs

CALL UCM80640

ADDING UNDERCARRIAGE CLEANING TO YOUR WASH INCREASES REVENUE!

Customers want to protect their vehicles from drainage problems due to debris and oil buildup, salt corrosion and more. Adding an undercarriage cleaning option to your bays or a stationary undercarriage cleaner to your automatics will keep your customers happy and your wallet full!

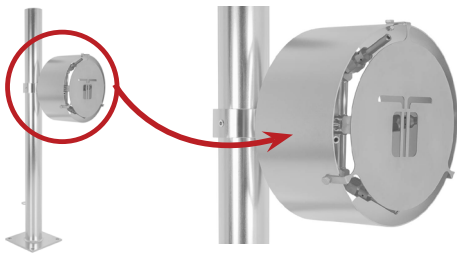

WHEELBLASTER PRO

MOSMATIC



- Polished stainless steel • Equipped with stabilizer nozzle
- Seamless height and angle adjustable • Multiple cleaning heads can be installed
- High impact at a distance
- **PRESSURE:** 4000 PSI • **MAX. TEMP:** 250°F
- **MAX. RPM:** 2000 • **WATER CONNECTION:** 3/8" NPTF
- **THROUGHPUT MEDIUM:** pH 3-12

CALL SWMTA84546



VERSATILE & HIGHLY EFFECTIVE!

TIRE CLEANER WITH 21" STAINLESS STEEL HOUSING

MOSMATIC



- The water pressure makes the rotor arm begin to turn on its own. The design is constructed so simply that any maintenance work can be carried out independently and very quickly. These products are found mainly in automatic car wash facilities in the area of rim/tire cleaning and lateral finish cleaning. It is an efficient and reliable method of achieving optimal cleaning results.

CALL SWMTC84519 High performance (DYT) Swivel, 18½" / 14" Spinner

SWMTC84504 Standard (DYF) Swivel, 16" / 10" Spinner

ROTATION SYSTEM

MOSMATIC



- As the water pressure builds, the rotor arms begin to rotate independently. The arm rotates only by the force of the water jet and requires no other power. A simple but efficient and solid product for optimal cleaning effect.
- Max. Pressure - 5000 PSI • Max. Temp. - 250°F • Stab. Nozzle / Adapter (4) 14.901

| PRICE | PART # | G1 (F) | NW | ROTARY UNION | ROTOR ARM | INSERT NOZZLE |
|-------------|-----------|---------|----|--------------|--------------|---------------|
| CALL | SWMT81920 | ¼" NPTF | ¼" | DYT (59.063) | 4w4 (82.954) | (4)0004EG |
| | SWMT81922 | ¾" NPTF | ¼" | DYT (59.163) | 4w4 (82.954) | (4)0004EG |

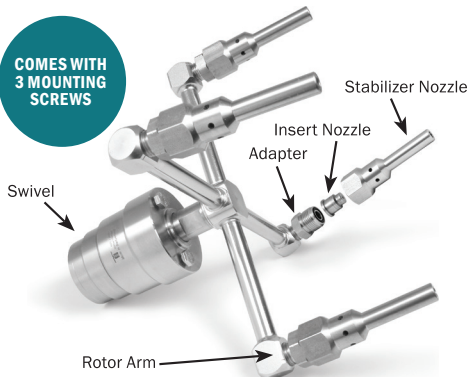

COMES WITH 3 MOUNTING SCREWS

Rotor Arm

AUTOMATICS & TUNNELS

PROTO-VEST DRYERS

CALL FOR PRICING



WINDSHEAR



S130



SIDESHOT



T130



T260



DIABLO

Update your existing dryer arch with directed air flow for Macneil, Peco and others (*dryer not included)

DRYERS

PROTO-VEST DRYERS

Proto-Vest Dryers

• PROTO-VEST DRYERS will improve the efficiency and profitability of any type of car wash including In bay, roll over and tunnel operations. PROTOVEST DRYERS provide the lowest energy usage and noise levels in the industry that save money for the wash operators.

FEATURES & BENEFITS:

- Constructed using Aircraft Grade Aluminum
- Unmatched Energy Efficiency
- LOW Maintenance
- Touchless Drying Directed Air Flow
- Patented Proto-Duck™ Air Deployment Bags
- Steel Blower Assemblies
- Easy to Install

COLOR CHOICES



ACTUAL COLOR MAY VARY FROM PICTURES SHOWN.
CUSTOM COLORS ALSO AVAILABLE UPON REQUEST.

DRYING PERFORMANCE IS AFFECTED BY THE FOLLOWING:

- 1 If the car is not clean;
- 2 Use of RO water without drying agent;
- 3 If cleaning agents are not properly balanced;
- 4 Insufficient rinsing (soap on vehicle);
- 5 Inadequate balance between rinse water & drying agent;
- 6 Excessive drive through speed.



PLEASE NOTE WHEN PURCHASING:

- Wiring and Controls to be provided by the purchaser
- Additional motor specifications available on request
- Additional Motor voltages available on special order
- Install not included

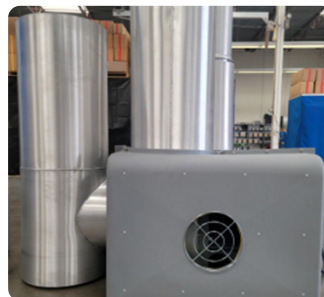

SILENCER PACKAGE PROTO-VEST DRYERS

Proto-Vest Dryers

- Above decibel readings are interpolated from T260 Dryer with 2 of the 30 Hp Motors

WITHOUT SILENCER

10 ft = 94 dBa
20 ft = 88 dBa

WITH SILENCER

10 ft = 88 dBa
20 ft = 82 dBa



AIRGATE PROTO-VEST DRYERS

- Reduce start up power consumption and prolong dryer motor life

AUTOMATICS & TUNNELS

TIRE BRUSHES

POODLE 96" x 12"/6" DIAMETER

4 BOLT ADAPTER

WELDED SHAFT



POODLE TIRE BRUSHES 96" LONG X ALTERNATING 12"/6" DIAMETER

UNIVERSAL BRUSH

Universal Brush
MANUFACTURING COMPANY
Premium quality brushes made in the USA for over 60 years

| MOUNTING: 4-BOLT ADAPTER | | |
|--------------------------|---------|-------|
| PRICE | PART # | COLOR |
| \$994.89 | UB500BK | Black |
| \$994.89 | UB500BL | Blue |
| \$994.89 | UB500R | Red |

| MOUNTING: WELDED SHAFT | | |
|------------------------|---------|-------|
| PRICE | PART # | COLOR |
| \$1,051.74 | UB502BK | Black |
| \$1,051.74 | UB502BL | Blue |
| \$1,051.74 | UB502R | Red |



TIRE DRESSING BRUSHES

UNIVERSAL BRUSH

Universal Brush
MANUFACTURING COMPANY
Premium quality brushes made in the USA for over 60 years

| MOUNTING: 4-BOLT ADAPTER | | |
|--------------------------|---------|-------|
| PRICE | PART # | COLOR |
| \$966.45 | UB520BK | Black |

| MOUNTING: WELDED SHAFT | | |
|------------------------|---------|-------|
| PRICE | PART # | COLOR |
| \$1,023.31 | UB522BK | Black |

STANDARD TIRE BRUSHES - 96" LONG x 8" DIAMETER

UNIVERSAL BRUSH

| NYLON/POLY MIX | | |
|--------------------------|---------|-------|
| MOUNTING: 4-BOLT ADAPTER | | |
| PRICE | PART # | COLOR |
| \$920.97 | UB504BK | Black |
| \$920.97 | UB504BL | Blue |
| \$920.97 | UB504R | Red |

| POLY | | |
|--------------------------|---------|-------|
| MOUNTING: 4-BOLT ADAPTER | | |
| PRICE | PART # | COLOR |
| \$767.49 | UB508BK | Black |
| \$767.49 | UB508BL | Blue |
| \$767.49 | UB508R | Red |

| MOUNTING: WELDED SHAFT | | |
|------------------------|---------|-------|
| PRICE | PART # | COLOR |
| \$977.82 | UB506BK | Black |
| \$977.82 | UB506BL | Blue |
| \$977.82 | UB506R | Red |

| MOUNTING: WELDED SHAFT | | |
|------------------------|---------|-------|
| PRICE | PART # | COLOR |
| \$824.34 | UB510BK | Black |
| \$824.34 | UB510BL | Blue |
| \$824.34 | UB510R | Red |

| NYLON | | |
|--------------------------|---------|-------|
| MOUNTING: 4-BOLT ADAPTER | | |
| PRICE | PART # | COLOR |
| \$1,364.41 | UB512BK | Black |

| MOUNTING: WELDED SHAFT | | |
|------------------------|---------|-------|
| PRICE | PART # | COLOR |
| \$1,421.25 | UB514BK | Black |



CLOTH TIRE BRUSHES

UNIVERSAL BRUSH

| MOUNTING: 4-BOLT ADAPTER | | |
|--------------------------|---------|-------|
| PRICE | PART # | COLOR |
| \$1,108.59 | UB516BK | Black |
| \$1,108.59 | UB516BL | Blue |
| \$1,108.59 | UB516R | Red |

| MOUNTING: WELDED SHAFT | | |
|------------------------|---------|-------|
| PRICE | PART # | COLOR |
| \$994.88 | UB518BK | Black |
| \$1,165.44 | UB518BL | Blue |
| \$1,165.44 | UB518R | Red |



4 BOLT SPINDLE

UNIVERSAL BRUSH

- For tire brush/poodle/wheel applicator - HANNA, Sonny's, Peco
- 4½" long
- 1¼" shaft down to 1" with key

\$79.58 UBA42016

WHEEL WONDER



PLEASE SPECIFY COLOR AND 4-BOLT MOUNT OR SHAFT WHEN ORDERING

ERIE WHEEL WONDER®

ERIE BRUSH



- Boasts constant full contact with the wheel. The washing material can be filament, Erie's Supreme Cloth or Erie's Gentle Foam.
- 96" in length or longer recommended - 18" major diameter recommended
- Dynamically balanced with solid, precise construction.
- Available with 4 bolt mount or keyed shaft or custom.
- MADE TO YOUR SPECIFICATION

| | | |
|------------|-----------|-----------------|
| \$1,462.89 | EB127100 | With Bolt Mount |
| \$1,510.81 | EB127100S | With Shaft Ends |

BEFORE ORDERING, PLEASE NOTE THE FOLLOWING:

- What are the measurements of your brush equipment?
- Who manufactures your equipment?
- What is the overall length and diameter?
- Is the shaft bolted or welded? If welded, what is the shaft length and diameter?

AUTOMATICS & TUNNELS

REPLACEMENT CLOTH & FOAM

KLEEN-RITE CORP. INTRODUCES FIVE STAR CARWASH CLOTH AND FIVE STAR FOAM.

This top of the line cloth is extremely durable and comes in four vibrant colors that are guaranteed not to fade prematurely.

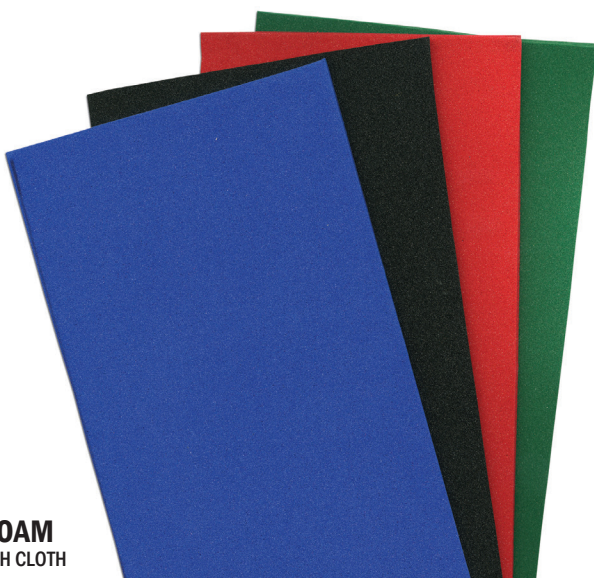

CAR WASH FOAM
FIVE STAR CAR WASH CLOTH

- Five Star Carwash Foam has the softest, most gentle touch. Five Star Foam Washing Material is lightweight, yet has tremendous tensile strength. The foam comes in 4 vibrant colors and is a great value.



CAR WASH CLOTH
FIVE STAR CAR WASH CLOTH

- Five Star Carwash Cloth has a soft and gentle touch while also being extremely durable. Five Star Cloth color's last and last, the color remains bright and vibrant throughout it's life. The cloth is also designed to hold more soap and water, resulting in cleaner vehicles.

HOW TO ORDER KLEEN-RITE'S 5 STAR CLOTH & FOAM

FOAM AND CLOTH AVAILABLE IN THE FOLLOWING COLORS:

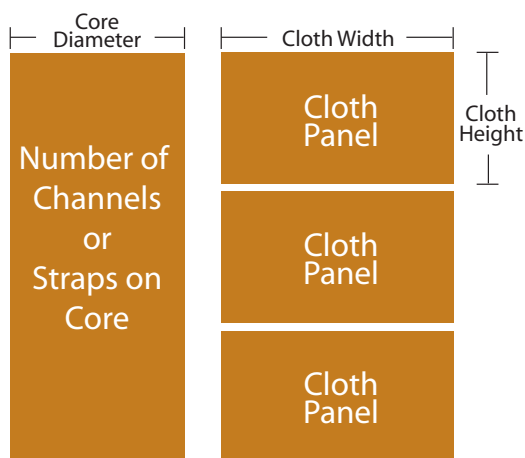

FOR CLOTH & FOAM REPLACEMENT
FIVE STAR CAR WASH CLOTH

- Measure cloth width & height.
- Measure slit size (1/2", 1", 2").
- Indicate if cloth is 1-ply or 2-ply.
- Indicate the number of pieces.

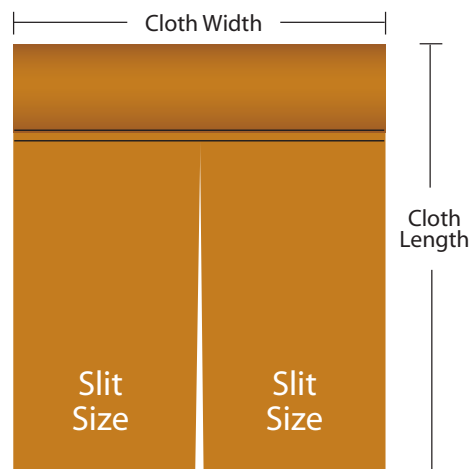

FOR MITTER CLOTH
FIVE STAR CAR WASH CLOTH

- Indicate if cloth has attached plastic rod, looped & sewn, or clip on/nylon tie style
- Measure cloth width & length.
- Measure slit size (2", 3", 4", 6").
- Indicate the number of pieces

REPLACEMENT CLOTH & FOAM- BELANGER® MODELS

FOAM AND CLOTH AVAILABLE IN THE FOLLOWING COLORS: ● ● ● ●

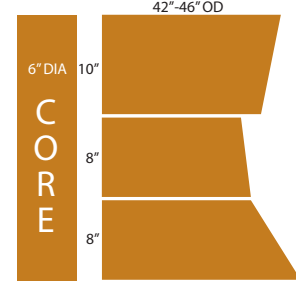
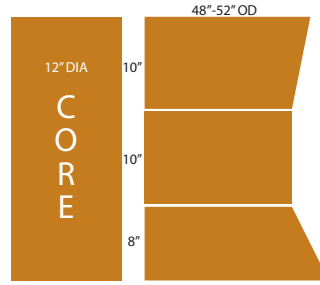
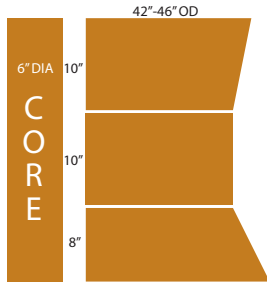

MODEL 2001 & 2x2 DRIVER SIDE 28" HIGH CORE FIVE STAR CAR WASH FOR BELANGER



- 6" Diameter core
- **CLOTH REPLACEMENT**
- 28 pcs: 10" x 18"/16"
- 28 pcs: 8" x 16"/20"
- 28 Channels x 28" high
- 28 pcs: 10" x 16"

| PRICE | PART# | MATERIAL | COLOR |
|----------|----------|----------|-------|
| \$534.39 | UBC100BL | Cloth | Blue |
| \$534.39 | UBC100BK | Cloth | Black |
| \$534.39 | UBC100R | Cloth | Red |
| \$534.39 | UBC100G | Cloth | Green |
| \$736.78 | UBF100BL | Foam | Blue |
| \$736.78 | UBF100BK | Foam | Black |
| \$736.78 | UBF100R | Foam | Red |
| \$736.78 | UBF100G | Foam | Green |

MODEL 2001 & 2x2 PASSENGER SIDE 28" HIGH CORE FIVE STAR CAR WASH FOR BELANGER



- 12" Diameter core
- **CLOTH REPLACEMENT**
- 44 pcs: 10" x 18"/16"
- 44 pcs: 8" x 16"/20"
- 44 Channels x 28" high
- 44 pcs: 10" x 16"

| PRICE | PART# | MATERIAL | COLOR |
|------------|----------|----------|-------|
| \$841.38 | UBC105BL | Cloth | Blue |
| \$841.38 | UBC105BK | Cloth | Black |
| \$841.38 | UBC105R | Cloth | Red |
| \$841.38 | UBC105G | Cloth | Green |
| \$1,150.65 | UBF105BL | Foam | Blue |
| \$1,150.65 | UBF105BK | Foam | Black |
| \$1,150.65 | UBF105R | Foam | Red |
| \$1,150.65 | UBF105G | Foam | Green |

MODEL 2x2 DRIVER SIDE 26" HIGH CORE FIVE STAR CAR WASH FOR BELANGER



- 6" Diameter core
- **CLOTH REPLACEMENT**
- 28 pcs: 10" x 18"/14"
- 28 pcs: 8" x 15"/20"
- 28 Channels x 26" high
- 28 pcs: 8" x 14"/15"

| PRICE | PART# | MATERIAL | COLOR |
|----------|----------|----------|-------|
| \$507.10 | UBC110BL | Cloth | Blue |
| \$507.10 | UBC110BK | Cloth | Black |
| \$507.10 | UBC110R | Cloth | Red |
| \$507.10 | UBC110G | Cloth | Green |
| \$704.94 | UBF110BL | Foam | Blue |
| \$704.94 | UBF110BK | Foam | Black |
| \$704.94 | UBF110R | Foam | Red |
| \$704.94 | UBF110G | Foam | Green |

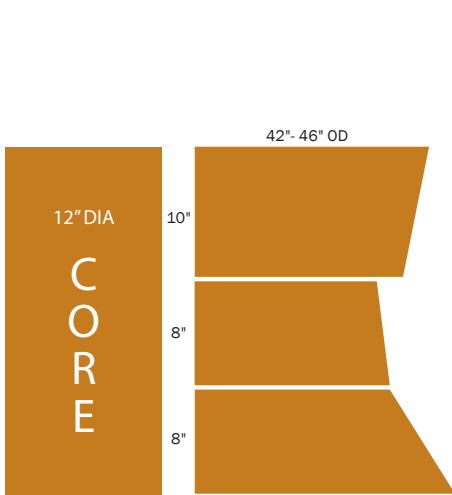

MODEL 2X2 DRIVER PASSENGER 26" HIGH CORE

FIVE STAR CAR WASH FOR BELANGER



- 12" Diameter core
- **CLOTH REPLACEMENT**
- 44 pcs: 10" x 18"/14"
- 44 pcs: 8" x 15"/20"
- 44 Channels x 28" high
- 44 pcs: 8" x 14"/15"

| PRICE | PART# | MATERIAL | COLOR |
|------------|----------|----------|-------|
| \$811.82 | UBC115BL | Cloth | Blue |
| \$811.82 | UBC115BK | Cloth | Black |
| \$811.82 | UBC115R | Cloth | Red |
| \$811.82 | UBC115G | Cloth | Green |
| \$1,091.52 | UBF115BL | Foam | Blue |
| \$1,091.52 | UBF115BK | Foam | Black |
| \$1,091.52 | UBF115R | Foam | Red |
| \$1,091.52 | UBF115G | Foam | Green |

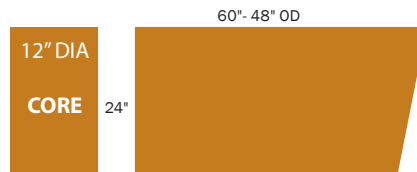

24" HIGH HITCH-HIKER FIVE STAR CAR WASH FOR BELANGER



- 12" Diameter core
- **CLOTH REPLACEMENT**
- 12 Channels x 24" high
- 12 pcs: 24" x 24"/18"

| PRICE | PART# | MATERIAL | COLOR |
|----------|----------|----------|-------|
| \$181.92 | UBC120BL | Cloth | Blue |
| \$181.92 | UBC120BK | Cloth | Black |
| \$181.92 | UBC120R | Cloth | Red |
| \$181.92 | UBC120G | Cloth | Green |
| \$288.80 | UBF120BL | Foam | Blue |
| \$288.80 | UBF120BK | Foam | Black |
| \$288.80 | UBF120R | Foam | Red |
| \$288.80 | UBF120G | Foam | Green |

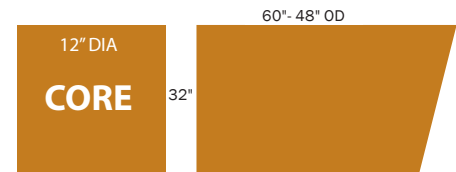

32" HIGH HITCH-HIKER FIVE STAR CAR WASH FOR BELANGER



- 12" Diameter core
- **CLOTH REPLACEMENT**
- 12 Channels x 32" high
- 12 pcs: 32" x 24"/18"

| PRICE | PART# | MATERIAL | COLOR |
|----------|----------|----------|-------|
| \$234.22 | UBC125BL | Cloth | Blue |
| \$234.22 | UBC125BK | Cloth | Black |
| \$234.22 | UBC125R | Cloth | Red |
| \$234.22 | UBC125G | Cloth | Green |
| \$372.93 | UBF125BL | Foam | Blue |
| \$372.93 | UBF125BK | Foam | Black |
| \$372.93 | UBF125R | Foam | Red |
| \$372.93 | UBF125G | Foam | Green |

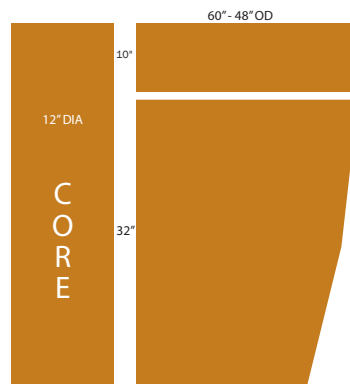

42" COMBO WASH™ MODULE WRAP TOP

FIVE STAR CAR WASH FOR BELANGER



- 12" Diameter core
- **CLOTH REPLACEMENT**
- 12 pcs: 10" x 24"
- 12 Channels x 42" high
- 12 pcs: 32" x 24"/18"

| PRICE | PART# | MATERIAL | COLOR |
|----------|----------|----------|-------|
| \$327.45 | UBC160BL | Cloth | Blue |
| \$327.45 | UBC160BK | Cloth | Black |
| \$327.45 | UBC160R | Cloth | Red |
| \$327.45 | UBC160G | Cloth | Green |
| \$502.55 | UBF160BL | Foam | Blue |
| \$502.55 | UBF160BK | Foam | Black |
| \$502.55 | UBF160R | Foam | Red |
| \$502.55 | UBF160G | Foam | Green |

REPLACEMENT CLOTH & FOAM- BELANGER® MODELS

FOAM AND CLOTH AVAILABLE IN THE FOLLOWING COLORS: ● ● ● ●

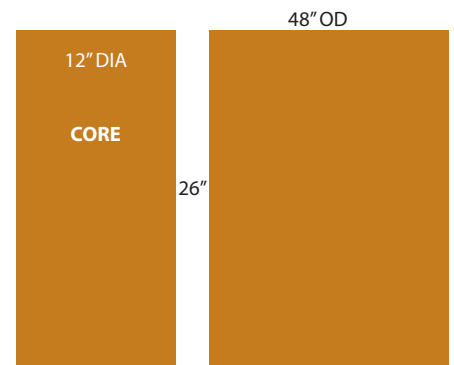
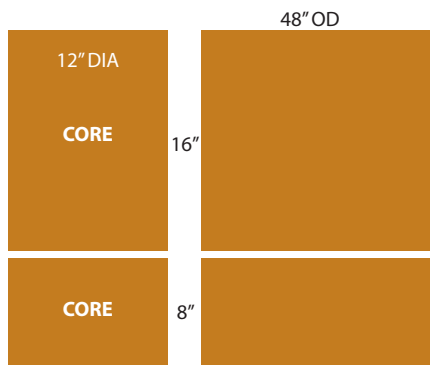
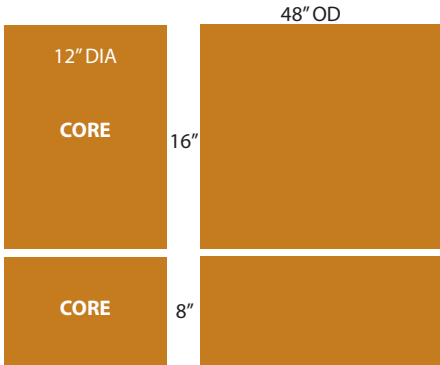

24" COMBO WASH™ MODULE WRAP BOTTOM

FIVE STAR CAR WASH FOR BELANGER



- 12" Diameter core
- CLOTH REPLACEMENT
- 44 pcs: 16" x 18"
- 44 Channels x 24" high
- 44 pcs: 8" x 18"

24" WRAP AROUND WITH CLUTCH

FIVE STAR CAR WASH F BELANGER



- 12" Diameter core
- CLOTH REPLACEMENT
- 44 pcs: 16" x 18"
- 44 Channels x 24" high
- 44 pcs: 8" x 18"

26" WRAP AROUND WHEEL WITH CLUTCH

FIVE STAR CAR WASH FOR BELANGER



- 12" Diameter core
- CLOTH REPLACEMENT
- 44 pcs: 26" x 18"
- 44 Channels x 26" high

| PRICE | PART# | MATERIAL | COLOR |
|----------|----------|----------|-------|
| \$670.83 | UBC155BL | Cloth | Blue |
| \$670.83 | UBC155BK | Cloth | Black |
| \$670.83 | UBC155R | Cloth | Red |
| \$670.83 | UBC155G | Cloth | Green |
| \$902.78 | UBF155BL | Foam | Blue |
| \$902.78 | UBF155BK | Foam | Black |
| \$902.78 | UBF155R | Foam | Red |
| \$902.78 | UBF155G | Foam | Green |

| PRICE | PART# | MATERIAL | COLOR |
|----------|----------|----------|-------|
| \$670.83 | UBC130BL | Cloth | Blue |
| \$670.83 | UBC130BK | Cloth | Black |
| \$670.83 | UBC130R | Cloth | Red |
| \$670.83 | UBC130G | Cloth | Green |
| \$902.79 | UBF130BL | Foam | Blue |
| \$902.79 | UBF130BK | Foam | Black |
| \$902.79 | UBF130R | Foam | Red |
| \$902.79 | UBF130G | Foam | Green |

| PRICE | PART# | MATERIAL | COLOR |
|----------|----------|----------|-------|
| \$566.23 | UBC135BL | Cloth | Blue |
| \$566.23 | UBC135BK | Cloth | Black |
| \$566.23 | UBC135R | Cloth | Red |
| \$566.23 | UBC135G | Cloth | Green |
| \$889.14 | UBF135BL | Foam | Blue |
| \$889.14 | UBF135BK | Foam | Black |
| \$889.14 | UBF135R | Foam | Red |
| \$889.14 | UBF135G | Foam | Green |

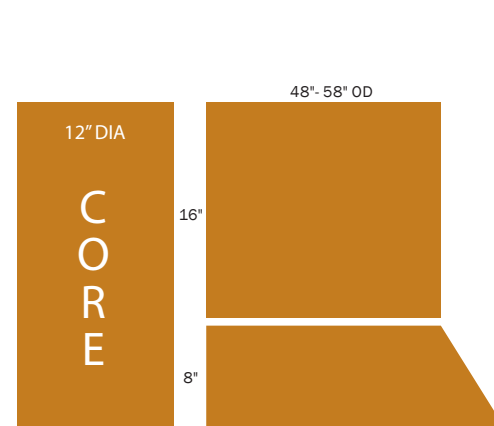
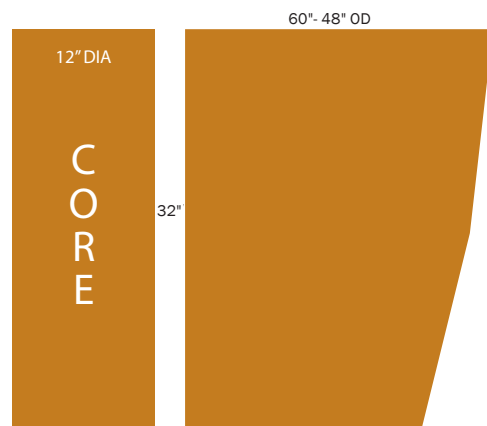
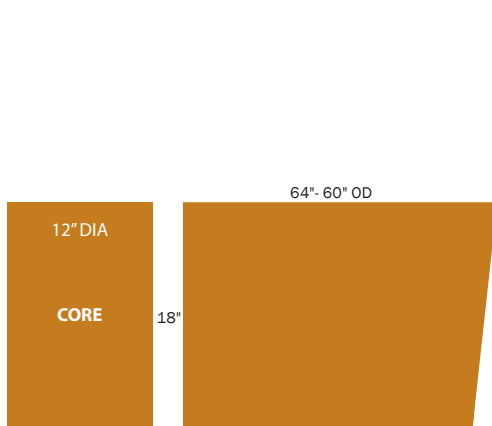

18" PROGRAMMABLE SIDE WASHER TOP SECTION

FIVE STAR CAR WASH FOR BELANGER



- 12" Diameter core
- CLOTH REPLACEMENT
- 12 pcs: 18" x 26"/24"
- 12 Channels x 18" high

32" PROGRAMMABLE SIDE WASHER CENTER SECTION

FIVE STAR CAR WASH FOR BELANGER



- 12" Diameter core
- CLOTH REPLACEMENT
- 12 pcs: 32" x 24"/18"
- 12 Channels x 32" high

24" PROGRAMMABLE SIDE WASHER BOTTOM SECTION

FIVE STAR CAR WASH FOR BELANGER



- 12" Diameter core
- CLOTH REPLACEMENT
- 44 pcs: 16" x 18"
- 44 Channels x 24" high
- 44 pcs: 8" x 18"/23"

| PRICE | PART# | MATERIAL | COLOR |
|----------|----------|----------|-------|
| \$161.46 | UBC140BL | Cloth | Blue |
| \$161.46 | UBC140BK | Cloth | Black |
| \$161.46 | UBC140R | Cloth | Red |
| \$161.46 | UBC140G | Cloth | Green |
| \$263.79 | UBF140BL | Foam | Blue |
| \$263.79 | UBF140BK | Foam | Black |
| \$263.79 | UBF140R | Foam | Red |
| \$263.79 | UBF140G | Foam | Green |

| PRICE | PART# | MATERIAL | COLOR |
|----------|----------|----------|-------|
| \$234.23 | UBC145BL | Cloth | Blue |
| \$234.23 | UBC145BK | Cloth | Black |
| \$234.23 | UBC145R | Cloth | Red |
| \$234.23 | UBC145G | Cloth | Green |
| \$372.93 | UBF145BL | Foam | Blue |
| \$372.93 | UBF145BK | Foam | Black |
| \$372.93 | UBF145R | Foam | Red |
| \$372.93 | UBF145G | Foam | Green |

| PRICE | PART# | MATERIAL | COLOR |
|----------|----------|----------|-------|
| \$686.75 | UBC150BL | Cloth | Blue |
| \$686.75 | UBC150BK | Cloth | Black |
| \$686.75 | UBC150R | Cloth | Red |
| \$686.75 | UBC150G | Cloth | Green |
| \$936.89 | UBF150BL | Foam | Blue |
| \$936.89 | UBF150BK | Foam | Black |
| \$936.89 | UBF150R | Foam | Red |
| \$936.89 | UBF150G | Foam | Green |

REPLACEMENT CLOTH & FOAM- ECONOCRAFT® MODELS

FOAM AND CLOTH AVAILABLE IN THE FOLLOWING COLORS: ● ● ● ●

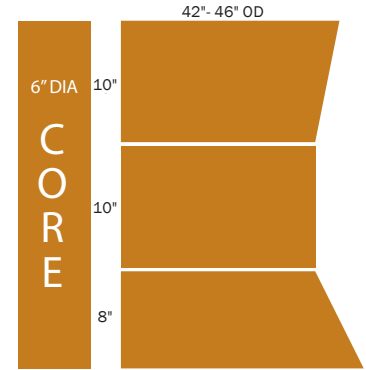
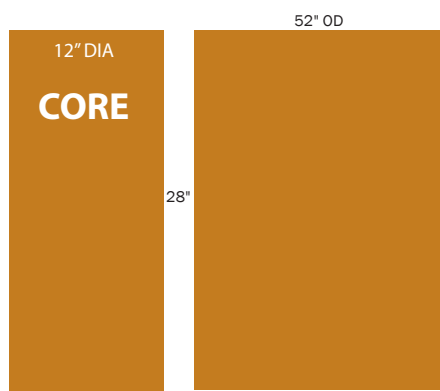
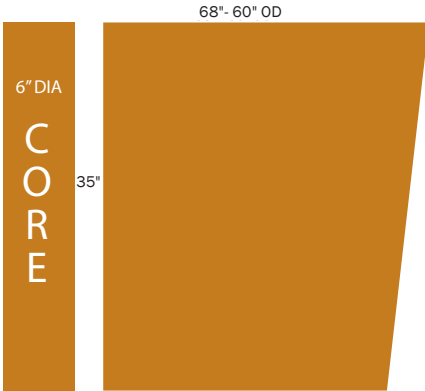

35" VAN HIGH BRUSH TOP SECTION
FIVE STAR CAR WASH FOR ECONOCRAFT



- 6" Diameter core
- 16 Channels x 35" high
- **CLOTH REPLACEMENT**
- 16 pcs: 35" x 31"/27"

28" VAN HIGH BRUSH BOTTOM SECTION
FIVE STAR CAR WASH FOR ECONOCRAFT



- 12" Diameter core
- 48 Channels x 28" high
- **CLOTH REPLACEMENT**
- 48 pcs: 28" x 20"

28" HIGH DRIVER SIDE BRUSH
FIVE STAR CAR WASH FOR ECONOCRAFT



- 6" Diameter core
- 32 Channels x 28" high
- **CLOTH REPLACEMENT**
- 32 pcs: 10" x 18"/16"
- 32 pcs: 10" x 16"
- 32 pcs: 8" x 16"/20"

| PRICE | PART# | MATERIAL | COLOR |
|-----------------|-----------------|----------|-------|
| \$409.32 | UBC200BL | Cloth | Blue |
| \$409.32 | UBC200BK | Cloth | Black |
| \$409.32 | UBC200R | Cloth | Red |
| \$409.32 | UBC200G | Cloth | Green |
| \$600.33 | UBF200BL | Foam | Blue |
| \$600.33 | UBF200BK | Foam | Black |
| \$600.33 | UBF200R | Foam | Red |
| \$600.33 | UBF200G | Foam | Green |

| PRICE | PART# | MATERIAL | COLOR |
|-------------------|-----------------|----------|-------|
| \$736.78 | UBC205BL | Cloth | Blue |
| \$736.78 | UBC205BK | Cloth | Black |
| \$736.78 | UBC205R | Cloth | Red |
| \$736.78 | UBC205G | Cloth | Green |
| \$1,036.94 | UBF205BL | Foam | Blue |
| \$1,036.94 | UBF205BK | Foam | Black |
| \$1,036.94 | UBF205R | Foam | Red |
| \$1,036.94 | UBF205G | Foam | Green |

| PRICE | PART# | MATERIAL | COLOR |
|-----------------|-----------------|----------|-------|
| \$609.43 | UBC210BL | Cloth | Blue |
| \$609.43 | UBC210BK | Cloth | Black |
| \$609.43 | UBC210R | Cloth | Red |
| \$609.43 | UBC210G | Cloth | Green |
| \$836.83 | UBF210BL | Foam | Blue |
| \$836.83 | UBF210BK | Foam | Black |
| \$836.83 | UBF210R | Foam | Red |
| \$836.83 | UBF210G | Foam | Green |

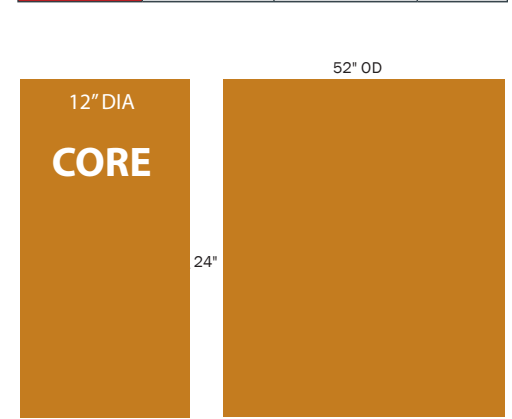
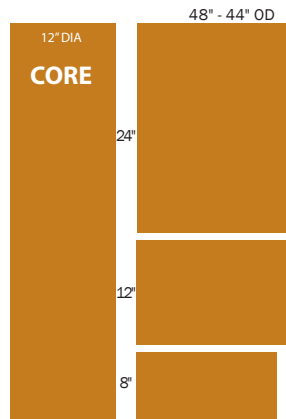
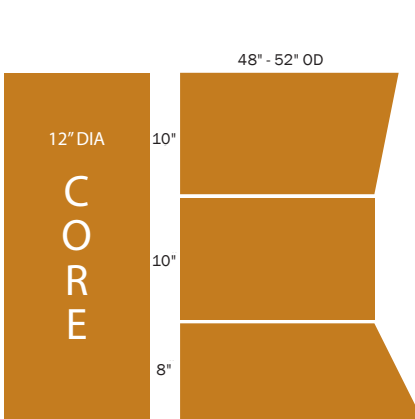

28" HIGH PASSENGER SIDE BRUSH
FIVE STAR CAR WASH FOR ECONOCRAFT



- 12" Diameter core
- 48 Channels x 28" high
- **CLOTH REPLACEMENT**
- 48 pcs: 10" x 18"/16"
- 48 pcs: 10" x 16"
- 48 pcs: 8" x 16"/20"

44" WRAP AROUND TOP SECTION
FIVE STAR CAR WASH FOR ECONOCRAFT



- 12" Diameter core
- 16 Channels x 44" high
- **CLOTH REPLACEMENT**
- 16 pcs: 24" x 18" W/ 2" Slit
- 16 pcs: 12" x 18" W/ 1" Slit
- 16 pcs: 8" x 16" W/ 1" Slit

24" WRAP AROUND BOTTOM SECTION
FIVE STAR CAR WASH FOR ECONOCRAFT



- 12" Diameter core
- 48 Channels x 24" high
- **CLOTH REPLACEMENT**
- 48 pcs: 24" x 18"

| PRICE | PART# | MATERIAL | COLOR |
|-------------------|-----------------|----------|-------|
| \$898.23 | UBC215BL | Cloth | Blue |
| \$898.23 | UBC215BK | Cloth | Black |
| \$898.23 | UBC215R | Cloth | Red |
| \$898.23 | UBC215G | Cloth | Green |
| \$1,255.25 | UBF215BL | Foam | Blue |
| \$1,255.25 | UBF215BK | Foam | Black |
| \$1,255.25 | UBF215R | Foam | Red |
| \$1,255.25 | UBF215G | Foam | Green |

| PRICE | PART# | MATERIAL | COLOR |
|-----------------|-----------------|----------|-------|
| \$395.67 | UBC220BL | Cloth | Blue |
| \$395.67 | UBC220BK | Cloth | Black |
| \$395.67 | UBC220R | Cloth | Red |
| \$395.67 | UBC220G | Cloth | Green |
| \$654.92 | UBF220BL | Foam | Blue |
| \$654.92 | UBF220BK | Foam | Black |
| \$543.49 | UBF220R | Foam | Red |
| \$654.92 | UBF220G | Foam | Green |

| PRICE | PART# | MATERIAL | COLOR |
|-----------------|-----------------|----------|-------|
| \$588.96 | UBC225BL | Cloth | Blue |
| \$588.96 | UBC225BK | Cloth | Black |
| \$588.96 | UBC225R | Cloth | Red |
| \$588.96 | UBC225G | Cloth | Green |
| \$895.96 | UBF225BL | Foam | Blue |
| \$895.96 | UBF225BK | Foam | Black |
| \$895.96 | UBF225R | Foam | Red |
| \$895.96 | UBF225G | Foam | Green |

REPLACEMENT CLOTH & FOAM- HANNA™ MODELS

FOAM AND CLOTH AVAILABLE IN THE FOLLOWING COLORS: ● ● ● ●

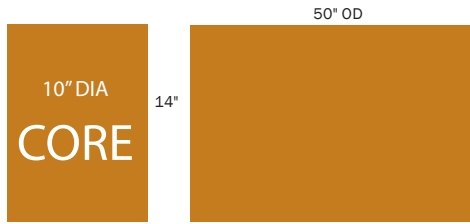

**HUBCAP ROCKER PANEL
10 x 14 x 50 STRAIGHT CUT**
FIVE STAR CAR WASH FOR HANNA



- 10" Diameter core
- 30 Channels x 14" high
- CLOTH REPLACEMENT
- 30 pcs: 14" x 20"

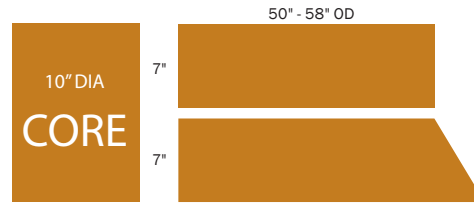

**HUBCAP ROCKER PANEL
10 x 14 x 50/58 ANGLE CUT**
FIVE STAR CAR WASH FOR HANNA



- 10" Diameter core
- 30 Channels x 14" high
- CLOTH REPLACEMENT
- 30 pcs: 7" x 20"

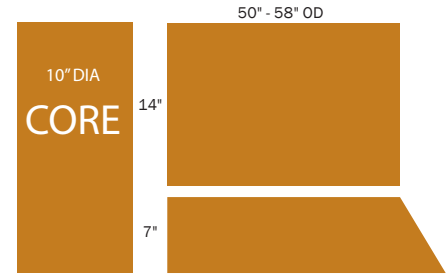

**HUBCAP ROCKER PANEL
10 x 21 x 50/58 ANGLE CUT**
FIVE STAR CAR WASH FOR HANNA



- 10" Diameter core
- 30 Channels x 14" high
- CLOTH REPLACEMENT
- 30 pcs: 14" x 20"

| PRICE | PART# | MATERIAL | COLOR |
|----------|----------|----------|-------|
| \$272.88 | UBC400BL | Cloth | Blue |
| \$272.88 | UBC400BK | Cloth | Black |
| \$272.88 | UBC400R | Cloth | Red |
| \$272.88 | UBC400G | Cloth | Green |
| \$393.40 | UBF400BL | Foam | Blue |
| \$393.40 | UBF400BK | Foam | Black |
| \$393.40 | UBF400R | Foam | Red |
| \$393.40 | UBF400G | Foam | Green |

| PRICE | PART# | MATERIAL | COLOR |
|----------|----------|----------|-------|
| \$345.64 | UBC405BL | Cloth | Blue |
| \$345.64 | UBC405BK | Cloth | Black |
| \$345.64 | UBC405R | Cloth | Red |
| \$345.64 | UBC405G | Cloth | Green |
| \$529.84 | UBF405BL | Foam | Blue |
| \$529.84 | UBF405BK | Foam | Black |
| \$529.84 | UBF405R | Foam | Red |
| \$529.84 | UBF405G | Foam | Green |

| PRICE | PART# | MATERIAL | COLOR |
|----------|----------|----------|-------|
| \$443.43 | UBC415BL | Cloth | Blue |
| \$443.43 | UBC415BK | Cloth | Black |
| \$443.43 | UBC415R | Cloth | Red |
| \$443.43 | UBC415G | Cloth | Green |
| \$648.09 | UBF415BL | Foam | Blue |
| \$648.09 | UBF415BK | Foam | Black |
| \$648.09 | UBF415R | Foam | Red |
| \$648.09 | UBF415G | Foam | Green |

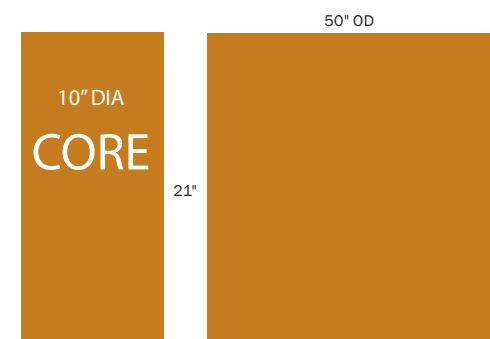

**HUBCAP ROCKER PANEL
10 x 21 x 50 STRAIGHT CUT**
FIVE STAR CAR WASH FOR HANNA

- 10" Diameter core
- 30 Channels x 21" high
- CLOTH REPLACEMENT
- 30 pcs: 21" x 20"

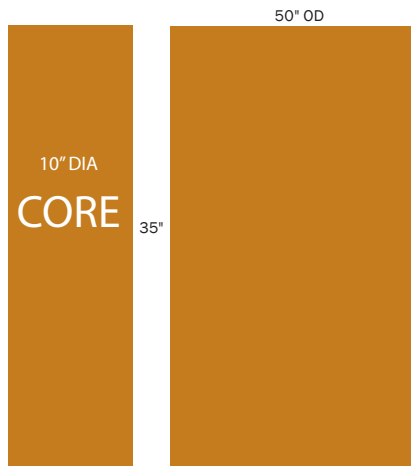

**HUBCAP ROCKER PANEL
10 x 35 x 50 STRAIGHT CUT**
FIVE STAR CAR WASH FOR HANNA



- 10" Diameter core
- 30 Channels x 35" high
- CLOTH REPLACEMENT
- 30 pcs: 35" x 20"

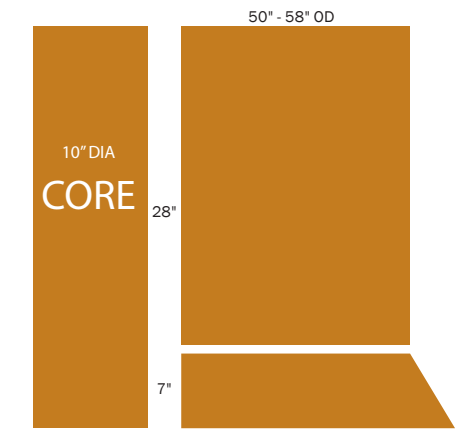

**HUBCAP ROCKER PANEL
10 x 35 x 50/58 ANGLE CUT**
FIVE STAR CAR WASH FOR HANNA



- 10" Diameter core
- 30 Channels x 35" high
- CLOTH REPLACEMENT
- 30 pcs: 28" x 20"

| PRICE | PART# | MATERIAL | COLOR |
|----------|----------|----------|-------|
| \$354.74 | UBC410BL | Cloth | Blue |
| \$354.74 | UBC410BK | Cloth | Black |
| \$354.74 | UBC410R | Cloth | Red |
| \$354.74 | UBC410G | Cloth | Green |
| \$545.77 | UBF410BL | Foam | Blue |
| \$545.77 | UBF410BK | Foam | Black |
| \$545.77 | UBF410R | Foam | Red |
| \$545.77 | UBF410G | Foam | Green |

| PRICE | PART# | MATERIAL | COLOR |
|----------|----------|----------|-------|
| \$562.82 | UBC420BL | Cloth | Blue |
| \$562.82 | UBC420BK | Cloth | Black |
| \$562.82 | UBC420R | Cloth | Red |
| \$562.82 | UBC420G | Cloth | Green |
| \$869.80 | UBF420BL | Foam | Blue |
| \$869.80 | UBF420BK | Foam | Black |
| \$869.80 | UBF420R | Foam | Red |
| \$869.80 | UBF420G | Foam | Green |

| PRICE | PART# | MATERIAL | COLOR |
|----------|----------|----------|-------|
| \$613.97 | UBC425BL | Cloth | Blue |
| \$613.97 | UBC425BK | Cloth | Black |
| \$613.97 | UBC425R | Cloth | Red |
| \$613.97 | UBC425G | Cloth | Green |
| \$959.64 | UBF425BL | Foam | Blue |
| \$959.64 | UBF425BK | Foam | Black |
| \$959.64 | UBF425R | Foam | Red |
| \$959.64 | UBF425G | Foam | Green |

REPLACEMENT CLOTH & FOAM- HANNA™ MODELS

FOAM AND CLOTH AVAILABLE IN THE FOLLOWING COLORS: ● ● ● ●

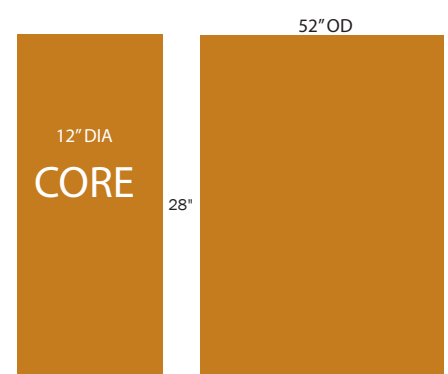
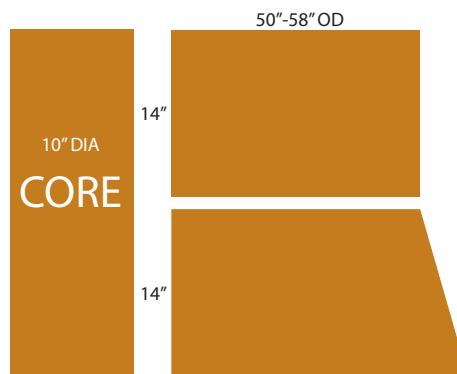
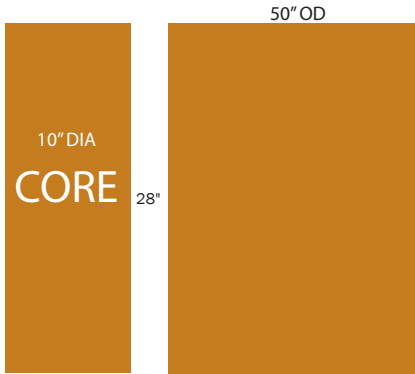

ROCKER PANEL SIDE WASHER
10 x 28 x 50 STRAIGHT CUT
FIVE STAR CAR WASH FOR HANNA



- 10" Diameter core
- 30 Channels x 28" high
- **CLOTH REPLACEMENT**
- 30 pcs: 28" x 20"

| PRICE | PART# | MATERIAL | COLOR |
|----------|----------|----------|-------|
| \$443.43 | UBC430BL | Cloth | Blue |
| \$443.43 | UBC430BK | Cloth | Black |
| \$443.43 | UBC430R | Cloth | Red |
| \$443.43 | UBC430G | Cloth | Green |
| \$657.19 | UBF430BL | Foam | Blue |
| \$657.19 | UBF430BK | Foam | Black |
| \$657.19 | UBF430R | Foam | Red |
| \$657.19 | UBF430G | Foam | Green |

ROCKER PANEL SIDE WASHER
10 x 28 x 50/58 ANGLE CUT
FIVE STAR CAR WASH FOR HANNA



- 10" Diameter core
- 30 Channels x 28" high
- **CLOTH REPLACEMENT**
- 30 pcs: 14" x 20"
- 30 pcs: 14" x 20"/24"

| PRICE | PART# | MATERIAL | COLOR |
|----------|----------|----------|-------|
| \$657.19 | UBC435BL | Cloth | Blue |
| \$561.68 | UBC435BK | Cloth | Black |
| \$561.68 | UBC435R | Cloth | Red |
| \$561.68 | UBC435G | Cloth | Green |
| \$818.64 | UBF435BL | Foam | Blue |
| \$818.64 | UBF435BK | Foam | Black |
| \$818.64 | UBF435R | Foam | Red |
| \$818.64 | UBF435G | Foam | Green |

ROCKER PANEL SIDE WASHER
12 x 28 x 52 STRAIGHT CUT
FIVE STAR CAR WASH FOR HANNA



- 12" Diameter core
- 36 Channels x 28" high
- **CLOTH REPLACEMENT**
- 36 pcs: 28" x 20"

| PRICE | PART# | MATERIAL | COLOR |
|----------|----------|----------|-------|
| \$532.12 | UBC440BL | Cloth | Blue |
| \$532.12 | UBC440BK | Cloth | Black |
| \$532.12 | UBC440R | Cloth | Red |
| \$532.12 | UBC440G | Cloth | Green |
| \$798.17 | UBF440BL | Foam | Blue |
| \$798.17 | UBF440BK | Foam | Black |
| \$798.17 | UBF440R | Foam | Red |
| \$798.17 | UBF440G | Foam | Green |

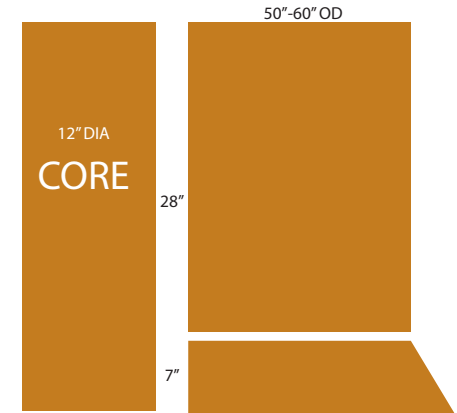
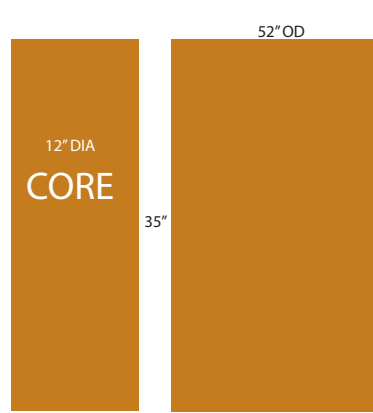
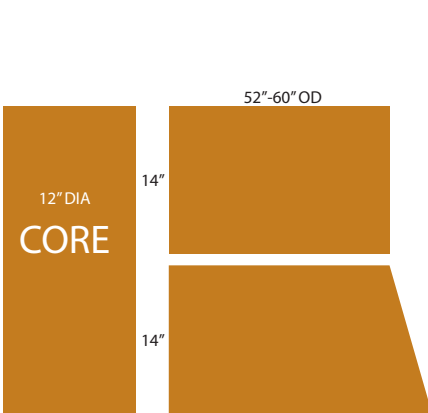

ROCKER PANEL SIDE WASHER
12 x 28 x 52/60 ANGLE CUT
FIVE STAR CAR WASH FOR HANNA



- 12" Diameter core
- 36 Channels x 28" high
- **CLOTH REPLACEMENT**
- 36 pcs: 14" x 20"
- 36 pcs: 14" x 20"/24"

| PRICE | PART# | MATERIAL | COLOR |
|----------|----------|----------|-------|
| \$670.83 | UBC445BL | Cloth | Blue |
| \$670.83 | UBC445BK | Cloth | Black |
| \$670.83 | UBC445R | Cloth | Red |
| \$670.83 | UBC445G | Cloth | Green |
| \$982.36 | UBF445BL | Foam | Blue |
| \$982.36 | UBF445BK | Foam | Black |
| \$982.36 | UBF445R | Foam | Red |
| \$982.36 | UBF445G | Foam | Green |

SIDE WASHER BRUSH
12 x 35 x 52 STRAIGHT CUT
FIVE STAR CAR WASH FOR HANNA



- 12" Diameter core
- 36 Channels x 25" high
- **CLOTH REPLACEMENT**
- 36 pcs: 35" x 20"

| PRICE | PART# | MATERIAL | COLOR |
|------------|----------|----------|-------|
| \$675.38 | UBC450BL | Cloth | Blue |
| \$675.38 | UBC450BK | Cloth | Black |
| \$675.38 | UBC450R | Cloth | Red |
| \$675.38 | UBC450G | Cloth | Green |
| \$1,043.77 | UBF450BL | Foam | Blue |
| \$1,043.77 | UBF450BK | Foam | Black |
| \$1,043.77 | UBF450R | Foam | Red |
| \$1,043.77 | UBF450G | Foam | Green |

SIDE WASHER BRUSH
12 x 35 x 60 ANGLE CUT
FIVE STAR CAR WASH FOR HANNA



- 12" Diameter core
- 36 Channels x 35" high
- **CLOTH REPLACEMENT**
- 36 pcs: 28" x 20"
- 36 pcs: 7" x 20"/24"

| PRICE | PART# | MATERIAL | COLOR |
|------------|----------|----------|-------|
| \$736.78 | UBC455BL | Cloth | Blue |
| \$736.78 | UBC455BK | Cloth | Black |
| \$736.78 | UBC455R | Cloth | Red |
| \$736.78 | UBC455G | Cloth | Green |
| \$1,150.64 | UBF455BL | Foam | Blue |
| \$1,150.64 | UBF455BK | Foam | Black |
| \$1,150.64 | UBF455R | Foam | Red |
| \$1,150.64 | UBF455G | Foam | Green |

REPLACEMENT CLOTH & FOAM- HANNA™ MODELS

FOAM AND CLOTH AVAILABLE IN THE FOLLOWING COLORS: ● ● ● ●

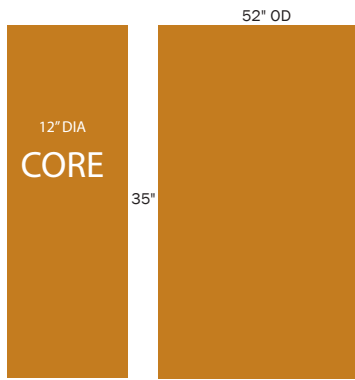

SIDE WASHER AROUND BRUSH 12 X 35 X 52 STRAIGHT CUT

FIVE STAR CAR WASH FOR HANNA



- 12" Diameter core
- 18 Channels x 35" high
- CLOTH REPLACEMENT
- 18 pcs: 35" x 20"

| PRICE | PART# | MATERIAL | COLOR |
|----------|----------|----------|-------|
| \$338.83 | UBC460BL | Cloth | Blue |
| \$338.83 | UBC460BK | Cloth | Black |
| \$338.83 | UBC460R | Cloth | Red |
| \$338.83 | UBC460G | Cloth | Green |
| \$523.02 | UBF460BL | Foam | Blue |
| \$523.02 | UBF460BK | Foam | Black |
| \$523.02 | UBF460R | Foam | Red |
| \$523.02 | UBF460G | Foam | Green |

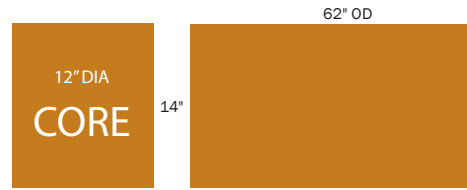

HORIZONTAL WINDOW WASHER 12 X 14 X 62 STRAIGHT CUT

FIVE STAR CAR WASH FOR HANNA



- 12" Diameter core
- 9 Channels x 14" high
- CLOTH REPLACEMENT
- 9 pcs: 14" x 25"

| PRICE | PART# | MATERIAL | COLOR |
|----------|----------|----------|-------|
| \$97.79 | UBC465BL | Cloth | Blue |
| \$97.79 | UBC465BK | Cloth | Black |
| \$97.79 | UBC465R | Cloth | Red |
| \$97.79 | UBC465G | Cloth | Green |
| \$168.28 | UBF465BL | Foam | Blue |
| \$168.28 | UBF465BK | Foam | Black |
| \$168.28 | UBF465R | Foam | Red |
| \$168.28 | UBF465G | Foam | Green |



HORIZONTAL WINDOW WASHER 12 X 21 X 62 STRAIGHT CUT

FIVE STAR CAR WASH FOR HANNA



- 12" Diameter core
- 9 Channels x 21" high
- CLOTH REPLACEMENT
- 9 pcs: 21" x 25"

| PRICE | PART# | MATERIAL | COLOR |
|----------|----------|----------|-------|
| \$131.89 | UBC470BL | Cloth | Blue |
| \$131.89 | UBC470BK | Cloth | Black |
| \$131.89 | UBC470R | Cloth | Red |
| \$131.89 | UBC470G | Cloth | Green |
| \$245.60 | UBF470BL | Foam | Blue |
| \$245.60 | UBF470BK | Foam | Black |
| \$245.60 | UBF470R | Foam | Red |
| \$245.60 | UBF470G | Foam | Green |

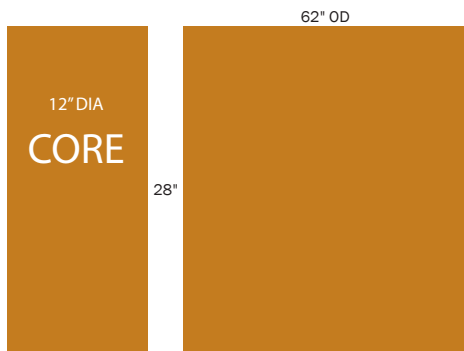

HORIZONTAL WINDOW WASHER 12 X 28 X 62 STRAIGHT CUT

FIVE STAR CAR WASH FOR HANNA



- 12" Diameter core
- 9 Channels x 28" high
- CLOTH REPLACEMENT
- 9 pcs: 28" x 25"

| PRICE | PART# | MATERIAL | COLOR |
|----------|----------|----------|-------|
| \$163.73 | UBC475BL | Cloth | Blue |
| \$163.73 | UBC475BK | Cloth | Black |
| \$163.73 | UBC475R | Cloth | Red |
| \$163.73 | UBC475G | Cloth | Green |
| \$327.45 | UBF475BL | Foam | Blue |
| \$327.45 | UBF475BK | Foam | Black |
| \$327.45 | UBF475R | Foam | Red |
| \$327.45 | UBF475G | Foam | Green |

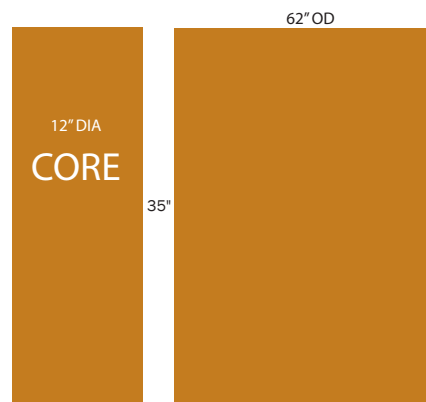

HORIZONTAL WINDOW WASHER 12 X 35 X 62 STRAIGHT CUT

FIVE STAR CAR WASH FOR HANNA



- 12" Diameter core
- 9 Channels x 35" high
- CLOTH REPLACEMENT
- 9 pcs: 35" x 25"

| PRICE | PART# | MATERIAL | COLOR |
|----------|----------|----------|-------|
| \$229.67 | UBC480BL | Cloth | Blue |
| \$229.67 | UBC480BK | Cloth | Black |
| \$229.67 | UBC480R | Cloth | Red |
| \$229.67 | UBC480G | Cloth | Green |
| \$409.33 | UBF480BL | Foam | Blue |
| \$409.33 | UBF480BK | Foam | Black |
| \$409.33 | UBF480R | Foam | Red |
| \$409.33 | UBF480G | Foam | Green |

KNOW WHEN TO REPLACE YOUR CLOTHS

Even the most experienced and conscientious operators eventually have to replace their cloth. Don't wait until the last minute to replace your cloth (when you have a series of damage claims or you start to lose customers because you are not doing a good enough job of cleaning their cars).

Excessive amounts of fraying and tearing at the tips of the cloth is a good indication it needs to be replaced.

REPLACEMENT CLOTH & FOAM- SONNY'S® MODELS

FOAM AND CLOTH AVAILABLE IN THE FOLLOWING COLORS: ● ● ● ●

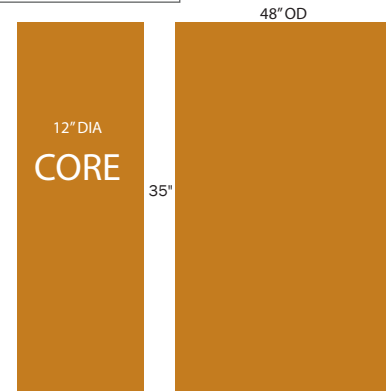
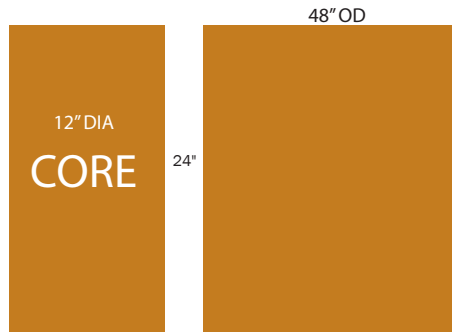
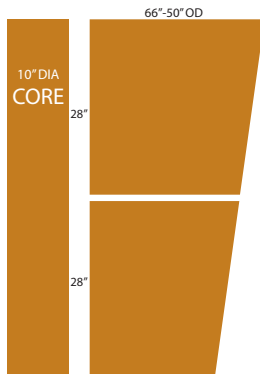

SF77 WRAP AROUND TOP SECTION

FIVE STAR CAR WASH FOR SONNY'S



- 10" Diameter core
- 10 Channels x 48" high
- **CLOTH REPLACEMENT**
- 10 pcs: 28" x 28"/24"
- 10 pcs: 4" x 20" x 24"/20"

| PRICE | PART# | MATERIAL | COLOR |
|----------|----------|----------|-------|
| \$345.64 | UBC500BL | Cloth | Blue |
| \$345.64 | UBC500BK | Cloth | Black |
| \$345.64 | UBC500R | Cloth | Red |
| \$345.64 | UBC500G | Cloth | Green |
| \$584.42 | UBF500BL | Foam | Blue |
| \$584.42 | UBF500BK | Foam | Black |
| \$584.42 | UBF500R | Foam | Red |
| \$584.42 | UBF500G | Foam | Green |

SF77 WRAP AROUND BOTTOM SECTION

FIVE STAR CAR WASH FOR SONNY'S



- 12" Diameter core
- 44 Channels x 24" high
- **CLOTH REPLACEMENT**
- 22 pcs: 24" x 18" 1-ply
- 22 pcs: 24" x 18" 2-ply

* ALTERNATE 1-PLY/2-PLY EVERY OTHER CHANNEL

| PRICE | PART# | MATERIAL | COLOR |
|------------|----------|----------|-------|
| \$759.51 | UBC505BL | Cloth | Blue |
| \$759.51 | UBC505BK | Cloth | Black |
| \$759.51 | UBC505R | Cloth | Red |
| \$759.51 | UBC505G | Cloth | Green |
| \$1,150.65 | UBF505BL | Foam | Blue |
| \$1,150.65 | UBF505BK | Foam | Black |
| \$1,150.65 | UBF505R | Foam | Red |
| \$1,150.65 | UBF505G | Foam | Green |

SFB35 WHEEL

FIVE STAR CAR WASH FOR SONNY'S



- 12" Diameter core
- 44 Channels x 35" high
- **CLOTH REPLACEMENT**
- 44 pcs: 35" x 18"

| PRICE | PART# | MATERIAL | COLOR |
|------------|----------|----------|-------|
| \$700.40 | UBC510BL | Cloth | Blue |
| \$700.40 | UBC510BK | Cloth | Black |
| \$700.40 | UBC510R | Cloth | Red |
| \$700.40 | UBC510G | Cloth | Green |
| \$1,155.19 | UBF510BL | Foam | Blue |
| \$1,155.19 | UBF510BK | Foam | Black |
| \$1,155.19 | UBF510R | Foam | Red |
| \$1,155.19 | UBF510G | Foam | Green |

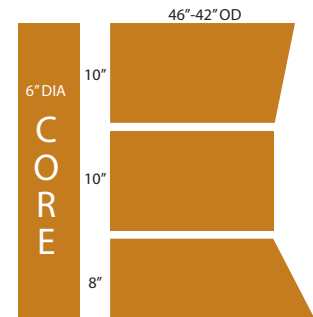
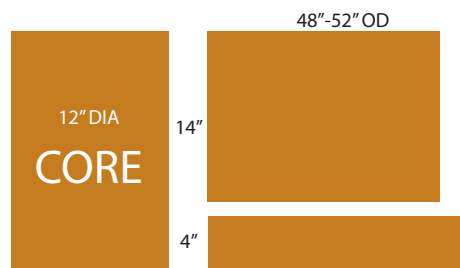
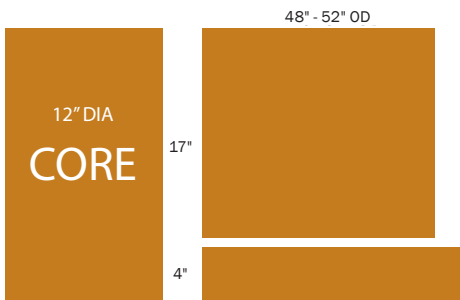

SFB21 WHEEL

FIVE STAR CAR WASH FOR SONNY'S



- 12" Diameter core
- 44 Channels x 21" high
- **CLOTH REPLACEMENT**
- 22 pcs: 17" x 18"
- 44 pcs: 4" x 20"

| PRICE | PART# | MATERIAL | COLOR |
|----------|----------|----------|-------|
| \$404.77 | UBC515BL | Cloth | Blue |
| \$404.77 | UBC515BK | Cloth | Black |
| \$404.77 | UBC515R | Cloth | Red |
| \$404.77 | UBC515G | Cloth | Green |
| \$579.87 | UBF515BL | Foam | Blue |
| \$579.87 | UBF515BK | Foam | Black |
| \$579.87 | UBF515R | Foam | Red |
| \$579.87 | UBF515G | Foam | Green |

SFB18 WHEEL

FIVE STAR CAR WASH FOR SONNY'S



- 12" Diameter core
- 44 Channels x 18" high
- **CLOTH REPLACEMENT**
- 22 pcs: 14" x 18"
- 44 pcs: 4" x 20"

| PRICE | PART# | MATERIAL | COLOR |
|----------|----------|----------|-------|
| \$375.21 | UBC520BL | Cloth | Blue |
| \$375.21 | UBC520BK | Cloth | Black |
| \$375.21 | UBC520R | Cloth | Red |
| \$375.21 | UBC520G | Cloth | Green |
| \$575.32 | UBF520BL | Foam | Blue |
| \$575.32 | UBF520BK | Foam | Black |
| \$575.32 | UBF520R | Foam | Red |
| \$575.32 | UBF520G | Foam | Green |

SF1 • SF2 • SF3 DRIVE SIDE WHEEL

FIVE STAR CAR WASH FOR SONNY'S



- 6" Diameter core
- 28 Channels x 28" high
- **CLOTH REPLACEMENT**
- 28 pcs: 10" x 18"/16"
- 28 pcs: 10" x 16"
- 28 pcs: 8" x 16"/20"

| PRICE | PART# | MATERIAL | COLOR |
|----------|----------|----------|-------|
| \$534.39 | UBC525BL | Cloth | Blue |
| \$534.39 | UBC525BK | Cloth | Black |
| \$534.39 | UBC525R | Cloth | Red |
| \$534.39 | UBC525G | Cloth | Green |
| \$732.23 | UBF525BL | Foam | Blue |
| \$732.23 | UBF525BK | Foam | Black |
| \$732.23 | UBF525R | Foam | Red |
| \$732.23 | UBF525G | Foam | Green |

REPLACEMENT CLOTH & FOAM- SONNY'S® MODELS

FOAM AND CLOTH AVAILABLE IN THE FOLLOWING COLORS: ● ● ● ●

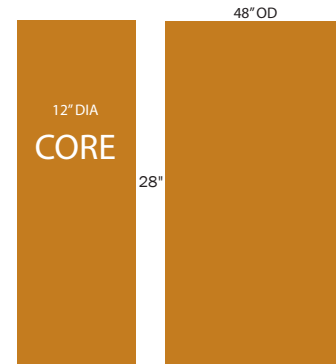
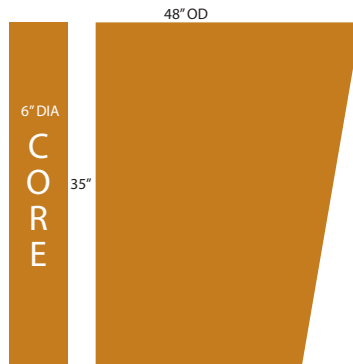
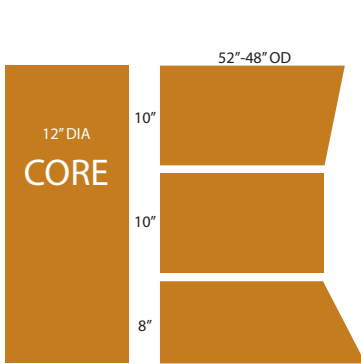

SF1 • SF2 • SF3 PASSENGER SIDE WHEEL/SFB28 WHEEL

FIVE STAR CAR WASH FOR SONNY'S



- 12" Diameter core
- CLOTH REPLACEMENT
- 44 pcs: 10" x 18"/16"
- 44 pcs: 8" x 16"/20"
- 44 Channels x 28" high
- 44 pcs: 10" x 16"

| PRICE | PART# | MATERIAL | COLOR |
|------------|----------|----------|-------|
| \$841.38 | UBC530BL | Cloth | Blue |
| \$841.38 | UBC530BK | Cloth | Black |
| \$841.38 | UBC530R | Cloth | Red |
| \$841.38 | UBC530G | Cloth | Green |
| \$1,150.64 | UBF530BL | Foam | Blue |
| \$1,150.64 | UBF530BK | Foam | Black |
| \$1,150.64 | UBF530R | Foam | Red |
| \$1,150.64 | UBF530G | Foam | Green |

SF63 TOP SECTION

FIVE STAR CAR WASH FOR SONNY'S



- 6" Diameter core
- CLOTH REPLACEMENT
- 12 pcs: 35" x 27"/21"
- 12 Channels x 35" high

| PRICE | PART# | MATERIAL | COLOR |
|----------|----------|----------|-------|
| \$281.98 | UBC535BL | Cloth | Blue |
| \$281.98 | UBC535BK | Cloth | Black |
| \$281.98 | UBC535R | Cloth | Red |
| \$281.98 | UBC535G | Cloth | Green |
| \$479.81 | UBF535BL | Foam | Blue |
| \$479.81 | UBF535BK | Foam | Black |
| \$479.81 | UBF535R | Foam | Red |
| \$479.81 | UBF535G | Foam | Green |

SF63 BOTTOM SECTION

FIVE STAR CAR WASH FOR SONNY'S



- 12" Diameter core
- CLOTH REPLACEMENT
- 44 pcs: 28" x 18"
- 44 Channels x 28" high

| PRICE | PART# | MATERIAL | COLOR |
|----------|----------|----------|-------|
| \$613.98 | UBC540BL | Cloth | Blue |
| \$613.98 | UBC540BK | Cloth | Black |
| \$613.98 | UBC540R | Cloth | Red |
| \$613.98 | UBC540G | Cloth | Green |
| \$950.53 | UBF540BL | Foam | Blue |
| \$950.53 | UBF540BK | Foam | Black |
| \$950.53 | UBF540R | Foam | Red |
| \$950.53 | UBF540G | Foam | Green |

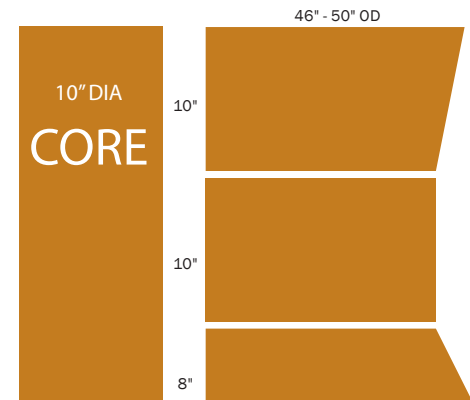
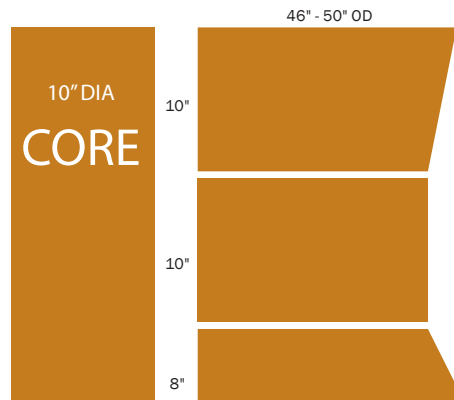
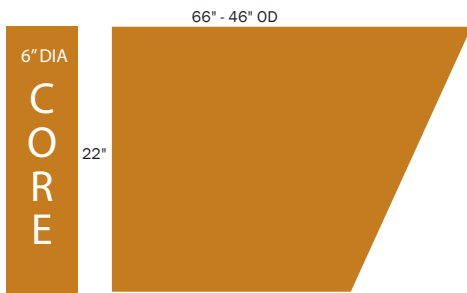

SF50 & SFB50 TOP SECTION

FIVE STAR CAR WASH FOR SONNY'S



- 6" Diameter core
- CLOTH REPLACEMENT
- 8 pcs: 22" x 30"/20"
- 8 Channels x 22" high

| PRICE | PART# | MATERIAL | COLOR |
|----------|----------|----------|-------|
| \$138.71 | UBC545BL | Cloth | Blue |
| \$138.71 | UBC545BK | Cloth | Black |
| \$138.71 | UBC545R | Cloth | Red |
| \$138.71 | UBC545G | Cloth | Green |
| \$209.21 | UBF545BL | Foam | Blue |
| \$209.21 | UBF545BK | Foam | Black |
| \$209.21 | UBF545R | Foam | Red |
| \$209.21 | UBF545G | Foam | Green |

SF50 BOTTOM SECTION

FIVE STAR CAR WASH FOR SONNY'S



- 10" Diameter core
- CLOTH REPLACEMENT
- 36 pcs: 10" x 18"/16"
- 36 pcs: 8" x 16"/20"
- 36 Channels x 28" high

| PRICE | PART# | MATERIAL | COLOR |
|----------|----------|----------|-------|
| \$686.74 | UBC550BL | Cloth | Blue |
| \$686.74 | UBC550BK | Cloth | Black |
| \$686.74 | UBC550R | Cloth | Red |
| \$686.74 | UBC550G | Cloth | Green |
| \$941.44 | UBF550BL | Foam | Blue |
| \$941.44 | UBF550BK | Foam | Black |
| \$941.44 | UBF550R | Foam | Red |
| \$941.44 | UBF550G | Foam | Green |

SFB50 BOTTOM SECTION

FIVE STAR CAR WASH FOR SONNY'S



- 10" Diameter core
- CLOTH REPLACEMENT
- 44 pcs: 10" x 18"/16"
- 44 pcs: 8" x 16"/20"
- 26 Channels x 28" high

| PRICE | PART# | MATERIAL | COLOR |
|------------|----------|----------|-------|
| \$841.38 | UBC552BL | Cloth | Blue |
| \$841.38 | UBC552BK | Cloth | Black |
| \$841.38 | UBC552R | Cloth | Red |
| \$841.38 | UBC552G | Cloth | Green |
| \$1,150.64 | UBF552BL | Foam | Blue |
| \$1,150.64 | UBF552BK | Foam | Black |
| \$1,150.64 | UBF552R | Foam | Red |
| \$1,150.64 | UBF552G | Foam | Green |

REPLACEMENT CLOTH & FOAM- SONNY'S® MODELS

FOAM AND CLOTH AVAILABLE IN THE FOLLOWING COLORS: ● ● ● ●

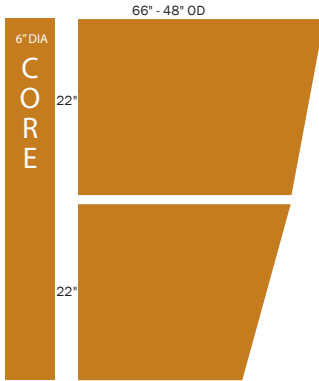

SF68 TOP SECTION
FIVE STAR CAR WASH FOR SONNY'S



- 6" Diameter core
- 8 Channels x 44" high
- **CLOTH REPLACEMENT**
- 8 pcs: 22" x 30"/26"
- 8 pcs: 22" x 26"/21"

| PRICE | PART# | MATERIAL | COLOR |
|-----------------|-----------------|----------|-------|
| \$281.98 | UBC555BL | Cloth | Blue |
| \$281.98 | UBC555BK | Cloth | Black |
| \$281.98 | UBC555R | Cloth | Red |
| \$281.98 | UBC555G | Cloth | Green |
| \$427.51 | UBF555BL | Foam | Blue |
| \$427.51 | UBF555BK | Foam | Black |
| \$427.51 | UBF555R | Foam | Red |
| \$427.51 | UBF555G | Foam | Green |

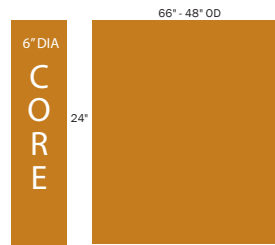

SF68 BOTTOM SECTION
FIVE STAR CAR WASH FOR SONNY'S



- 6" Diameter core
- 28 Channels x 24" high
- **CLOTH REPLACEMENT**
- 28 pcs: 24" x 21" 2-ply

| PRICE | PART# | MATERIAL | COLOR |
|-----------------|-----------------|----------|-------|
| \$677.64 | UBC560BL | Cloth | Blue |
| \$677.64 | UBC560BK | Cloth | Black |
| \$677.64 | UBC560R | Cloth | Red |
| \$677.64 | UBC560G | Cloth | Green |
| \$934.62 | UBF560BL | Foam | Blue |
| \$934.62 | UBF560BK | Foam | Black |
| \$934.62 | UBF560R | Foam | Red |
| \$934.62 | UBF560G | Foam | Green |

REPLACEMENT CLOTH & FOAM- PECO® MODELS

FOAM AND CLOTH AVAILABLE IN THE FOLLOWING COLORS: ● ● ● ●

**18" HUB CAP
ROCKER WASHER PE118**
FIVE STAR CAR WASH PECO



- 10" Diameter core
- 24 Channels x 18" high
- **CLOTH REPLACEMENT**
- 24 pcs: 13½" x 19"
- 24 pcs: 4" x 20"

| PRICE | PART# | MATERIAL | COLOR |
|-----------------|-----------------|----------|-------|
| \$375.22 | UBC300BL | Cloth | Blue |
| \$375.22 | UBC300BK | Cloth | Black |
| \$375.22 | UBC300R | Cloth | Red |
| \$375.22 | UBC300G | Cloth | Green |
| \$545.76 | UBF300BL | Foam | Blue |
| \$545.76 | UBF300BK | Foam | Black |
| \$545.76 | UBF300R | Foam | Red |
| \$545.76 | UBF300G | Foam | Green |

**28" DETAIL SIDE
WASHER PE128**
FIVE STAR CAR WASH PECO



- 10" Diameter core
- 36 Channels x 28" high
- **CLOTH REPLACEMENT**
- 72 pcs: 13½" x 20"

| PRICE | PART# | MATERIAL | COLOR |
|-----------------|-----------------|----------|-------|
| \$613.98 | UBC315BL | Cloth | Blue |
| \$613.98 | UBC315BK | Cloth | Black |
| \$613.98 | UBC315R | Cloth | Red |
| \$613.98 | UBC315G | Cloth | Green |
| \$982.37 | UBF315BL | Foam | Blue |
| \$982.37 | UBF315BK | Foam | Black |
| \$982.37 | UBF315R | Foam | Red |
| \$982.37 | UBF315G | Foam | Green |

**28" DELUXE VAN/SIDE
WASHER PE163**
FIVE STAR CAR WASH PECO



- 12" Diameter core
- 18 Channels x 28" high
- **CLOTH REPLACEMENT**
- 9 pcs: 13¾" x 23"/24" 1-ply w/1" slit
- 18 pcs: 13" x 6" one-play filter
- 9 pcs: 13¾" x 22"/23" 1-ply 1" slit

| PRICE | PART# | MATERIAL | COLOR |
|-----------------|-----------------|----------|-------|
| \$281.97 | UBC305BL | Cloth | Blue |
| \$281.97 | UBC305BK | Cloth | Black |
| \$281.97 | UBC305R | Cloth | Red |
| \$281.97 | UBC305G | Cloth | Green |
| \$386.58 | UBF305BL | Foam | Blue |
| \$386.58 | UBF305BK | Foam | Black |
| \$386.58 | UBF305R | Foam | Red |
| \$386.58 | UBF305G | Foam | Green |

**35" DELUXE VAN/SIDE WASHER
BOTTOM SECTION & DELUXE
DETAIL SIDE WASHER PE135**
FIVE STAR CAR WASH PECO®



- 12" Diameter core
- 36 Channels x 35" high
- **CLOTH REPLACEMENT**
- 36 pcs: 8" x 19" 1-ply
- 18 pcs: 18" x 19" 2-ply
- 18 pcs: 8" x 19" 2-ply
- 24 pcs: 17" x 6" 1-ply filter
- 18 pcs: 12" x 6" 1-ply filter

| PRICE | PART# | MATERIAL | COLOR |
|-------------------|-----------------|----------|-------|
| \$841.39 | UBC320BL | Cloth | Blue |
| \$841.39 | UBC320BK | Cloth | Black |
| \$841.39 | UBC320R | Cloth | Red |
| \$841.39 | UBC320G | Cloth | Green |
| \$1,168.84 | UBF320BL | Foam | Blue |
| \$1,168.84 | UBF320BK | Foam | Black |
| \$1,168.84 | UBF320R | Foam | Red |
| \$1,168.84 | UBF320G | Foam | Green |

**48" SOFT FLEX WRAP AROUND
PE372 TOP SECTION**
FIVE STAR CAR WASH PECO



- 12" Diameter core
- 10 Channels x 48" high
- **CLOTH REPLACEMENT**
- 10 pcs: 11⅞" x 20"/21½" 1-ply
- 10 pcs: 11⅞" x 21½"/23" 1-ply
- 10 pcs: 11⅞" x 23"/24½" 1-ply
- 10 pcs: 12½" x 24½"/26" 1-ply
- 10 pcs: 11⅞" x 5" 2-ply

| PRICE | PART# | MATERIAL | COLOR |
|-----------------|-----------------|----------|-------|
| \$397.95 | UBC310BL | Cloth | Blue |
| \$397.95 | UBC310BK | Cloth | Black |
| \$397.95 | UBC310R | Cloth | Red |
| \$397.95 | UBC310G | Cloth | Green |
| \$641.27 | UBF310BL | Foam | Blue |
| \$641.27 | UBF310BK | Foam | Black |
| \$641.27 | UBF310R | Foam | Red |
| \$641.27 | UBF310G | Foam | Green |

**24" SOFT FLEX WRAP AROUND
PE372 BOTTOM SECTION**
FIVE STAR CAR WASH PECO



- 12" Diameter core
- 36 Channels x 24" high
- **CLOTH REPLACEMENT**
- 24 pcs: 8" x 18" 1-ply
- 36 pcs: 16" x 18" 1-ply (Top 8" of pad is 2-ply)
- 12 pcs: Plastic Spacers

| PRICE | PART# | MATERIAL | COLOR |
|-----------------|-----------------|----------|-------|
| \$652.64 | UBC325BL | Cloth | Blue |
| \$652.64 | UBC325BK | Cloth | Black |
| \$652.64 | UBC325R | Cloth | Red |
| \$652.64 | UBC325G | Cloth | Green |
| \$986.92 | UBF325BL | Foam | Blue |
| \$986.92 | UBF325BK | Foam | Black |
| \$986.92 | UBF325R | Foam | Red |
| \$986.92 | UBF325G | Foam | Green |

REPLACEMENT CLOTH - BELANGER® MITTERS

FOAM AND CLOTH AVAILABLE IN THE FOLLOWING COLORS: ● ● ● ●

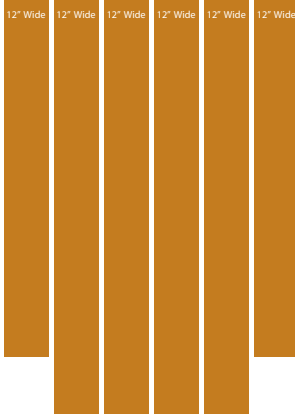

ROD STYLE

WHIPPER SNAPPER 6 BASKET VAN LENGTH CLOTH REPLACEMENT FOR BELANGER

- CLOTH REPLACEMENT
- 24 pcs: 12" x 76" with 6" slit
- 24 pcs: 12" x 94" with 4" slit
- 24 pcs: 12" x 94" with 3" slit

| PRICE | PART# | COLOR |
|-------------------|------------------|-------|
| \$1,637.28 | UBCM103BL | Blue |
| \$1,637.28 | UBCM103BK | Black |
| \$1,637.28 | UBCM103R | Red |
| \$1,637.28 | UBCM103G | Green |

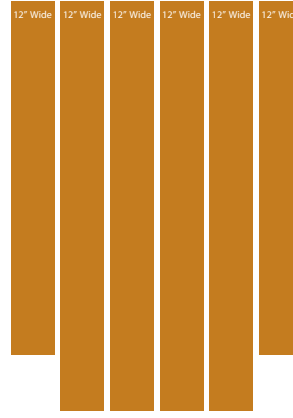

ROD STYLE

WHIPPER SNAPPER 6 BASKET CAR LENGTH CLOTH REPLACEMENT FOR BELANGER

- CLOTH REPLACEMENT
- 24 pcs: 12" x 58" with 6" slit
- 24 pcs: 12" x 76" with 4" slit
- 24 pcs: 12" x 76" with 3" slit

| PRICE | PART# | COLOR |
|-------------------|------------------|-------|
| \$1,414.42 | UBCM143BL | Blue |
| \$1,414.42 | UBCM143BK | Black |
| \$1,246.15 | UBCM143R | Red |
| \$1,414.42 | UBCM143G | Green |

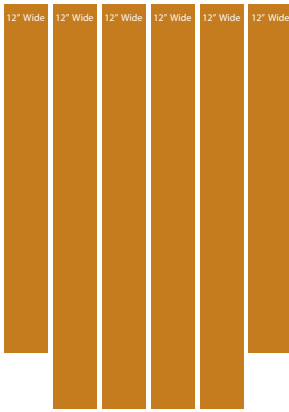

ROD STYLE

WHIPPER SNAPPER 4 BASKET VAN LENGTH CLOTH REPLACEMENT FOR BELANGER

- CLOTH REPLACEMENT
- 16 pcs: 12" x 76" with 6" slit
- 16 pcs: 12" x 94" with 4" slit
- 16 pcs: 12" x 94" with 3" slit

| PRICE | PART# | COLOR |
|-------------------|------------------|-------|
| \$1,091.52 | UBCM113BL | Blue |
| \$1,091.52 | UBCM113BK | Black |
| \$1,091.52 | UBCM113R | Red |
| \$1,091.52 | UBCM113G | Green |

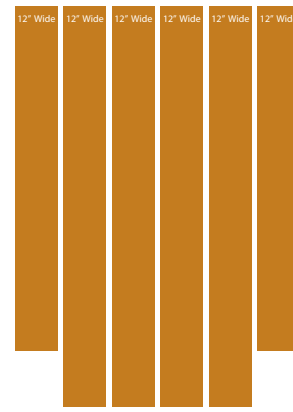

ROD STYLE

WHIPPER SNAPPER 4 BASKET CAR LENGTH CLOTH REPLACEMENT FOR BELANGER

- CLOTH REPLACEMENT
- 16 pcs: 12" x 58" with 6" slit
- 16 pcs: 12" x 76" with 4" slit
- 16 pcs: 12" x 76" with 3" slit

| PRICE | PART# | COLOR |
|-----------------|------------------|-------|
| \$955.08 | UBCM153BL | Blue |
| \$955.08 | UBCM153BK | Black |
| \$955.08 | UBCM153R | Red |
| \$955.08 | UBCM153G | Green |

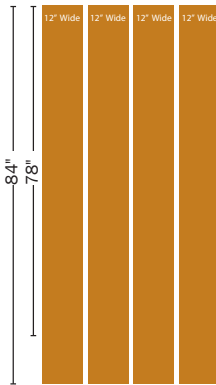

ROD STYLE

WHIPPER ACROSS 600 2' WIDE BASKET CLOTH REPLACEMENT FOR BELANGER

- CLOTH REPLACEMENT
- 32 pcs: 12" x 78" with 3" slit
- 32 pcs: 12" x 84" with 3" slit

| PRICE | PART# | COLOR |
|-------------------|------------------|-------|
| \$1,400.78 | UBCM123BL | Blue |
| \$1,400.78 | UBCM123BK | Black |
| \$1,400.78 | UBCM123R | Red |
| \$1,400.78 | UBCM123G | Green |

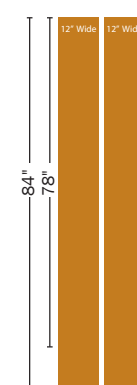

ROD STYLE

WHIPPER ACROSS 310 1' WIDE BASKET CLOTH REPLACEMENT FOR BELANGER

- CLOTH REPLACEMENT
- 16 pcs: 12" x 78" with 3" slit
- 16 pcs: 12" x 84" with 3" slit

| PRICE | PART# | COLOR |
|-----------------|------------------|-------|
| \$709.49 | UBCM163BL | Blue |
| \$709.49 | UBCM163BK | Black |
| \$709.49 | UBCM163R | Red |
| \$709.49 | UBCM163G | Green |

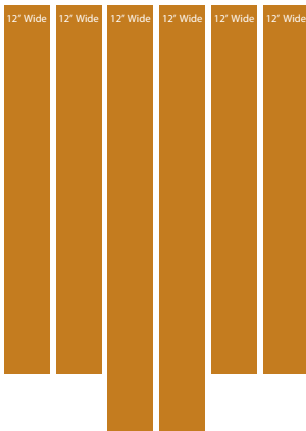

ROD STYLE

WHIP ACROSS 802 COMBO MODULE CLOTH REPLACEMENT FOR BELANGER

- CLOTH REPLACEMENT
- 16 pcs: 12" x 76" with 6" slit
- 16 pcs: 12" x 76" with 4" slit
- 16 pcs: 12" x 94" with 3" slit

| PRICE | PART# | COLOR |
|-------------------|------------------|-------|
| \$1,064.22 | UBCM133BL | Blue |
| \$1,064.22 | UBCM133BK | Black |
| \$1,064.22 | UBCM133R | Red |
| \$1,064.22 | UBCM133G | Green |

DOUBLE CROSS VAN LENGTH CLOTH REPLACEMENT FOR BELANGER

- CLOTH REPLACEMENT
- 48 pcs: 12" x 78" with 3" slit

| PRICE | PART# | COLOR |
|-------------------|------------------|-------|
| \$1,009.66 | UBCM173BL | Blue |
| \$1,009.66 | UBCM173BK | Black |
| \$1,009.66 | UBCM173R | Red |
| \$1,009.66 | UBCM173G | Green |

DOUBLE CROSS CAR LENGTH CLOTH REPLACEMENT FOR BELANGER

- CLOTH REPLACEMENT
- 48 pcs: 12" x 60" with 3" slit

| PRICE | PART# | COLOR |
|-----------------|------------------|-------|
| \$850.48 | UBCM183BL | Blue |
| \$850.48 | UBCM183BK | Black |
| \$850.48 | UBCM183R | Red |
| \$850.48 | UBCM183G | Green |

REPLACEMENT CLOTH - ECONOCRAFT® MITTERS

FOAM AND CLOTH AVAILABLE IN THE FOLLOWING COLORS: ● ● ● ●

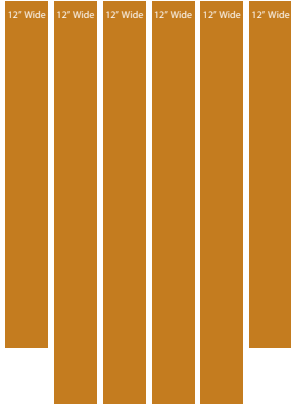

**WHIPPER SNAPPER
6 BASKET VAN LENGTH**
CLOTH REPLACEMENT FOR ECONOCRAFT

**ROD
STYLE**

- CLOTH REPLACEMENT
- 24 pcs: 12" x 76" with 6" slit
- 24 pcs: 12" x 94" with 4" slit
- 24 pcs: 12" x 94" with 3" slit

| PRICE | PART# | COLOR |
|-------------------|-----------|-------|
| \$1,637.28 | UBCM203BL | Blue |
| \$1,637.28 | UBCM203BK | Black |
| \$1,637.28 | UBCM203R | Red |
| \$1,637.28 | UBCM203G | Green |

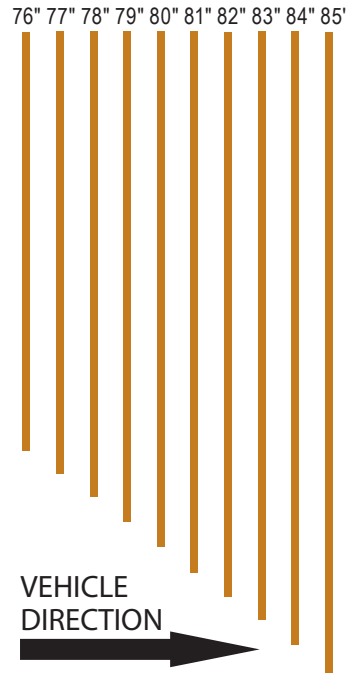

**10 ROW MITTER
VAN LENGTH**
CLOTH REPLACEMENT FOR ECONOCRAFT

**LOOPED
& SEWN**

- CLOTH REPLACEMENT
- 8 pcs: 12" x 85" with 3" slit
- 8 pcs: 12" x 84" with 3" slit
- 8 pcs: 12" x 83" with 3" slit
- 8 pcs: 12" x 82" with 3" slit
- 8 pcs: 12" x 81" with 3" slit
- 8 pcs: 12" x 80" with 3" slit
- 8 pcs: 12" x 79" with 3" slit
- 8 pcs: 12" x 78" with 3" slit
- 8 pcs: 12" x 77" with 3" slit
- 8 pcs: 12" x 76" with 3" slit

| PRICE | PART# | COLOR |
|-------------------|-----------|-------|
| \$1,750.98 | UBCM223BL | Blue |
| \$1,750.98 | UBCM223BK | Black |
| \$1,750.98 | UBCM223R | Red |
| \$1,750.98 | UBCM223G | Green |

**SIDE TO SIDE MITTER
VAN LENGTH**
CLOTH REPLACEMENT FOR ECONOCRAFT

**LOOPED
& SEWN**

- CLOTH REPLACEMENT
- 64 pcs: 12" x 94" with 3" slit

| PRICE | PART# | COLOR |
|-------------------|-----------|-------|
| \$1,596.35 | UBCM213BL | Blue |
| \$1,596.35 | UBCM213BK | Black |
| \$1,596.35 | UBCM213R | Red |
| \$1,596.35 | UBCM213G | Green |

REPLACEMENT CLOTH - PECO® MITTERS

FOAM AND CLOTH AVAILABLE IN THE FOLLOWING COLORS: ● ● ● ●

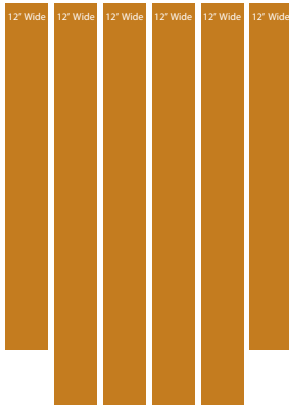

**MC04 MINI-WASH
ACROSS MITTER**
CLOTH REPLACEMENT FOR PECO

**LOOPED
& SEWN**

- CLOTH REPLACEMENT
- 16 pcs: 12" x 72" with 3" slit & 1" Loop
- 32 pcs: 12" x 80" with 3" slit & 1" Loop

| PRICE | PART# | COLOR |
|-------------------|-----------|-------|
| \$1,011.92 | UBCM303BL | Blue |
| \$1,011.92 | UBCM303BK | Black |
| \$1,011.92 | UBCM303R | Red |
| \$1,011.92 | UBCM303G | Green |

**MC02 MINI-WASH
ACROSS MITTER**
CLOTH REPLACEMENT FOR PECO

**LOOPED
& SEWN**

- CLOTH REPLACEMENT
- 32 pcs: 9" x 78" with 3" slit & 1" Loop

| PRICE | PART# | COLOR |
|-----------------|-----------|-------|
| \$541.21 | UBCM323BL | Blue |
| \$541.21 | UBCM323BK | Black |
| \$541.21 | UBCM323R | Red |
| \$541.21 | UBCM323G | Green |

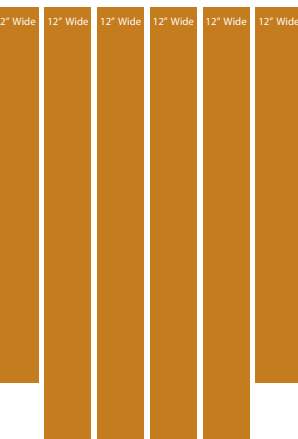

**MC06 WASH-ALONG
MITTER**
CLOTH REPLACEMENT FOR PECO

**LOOPED
& SEWN**

- CLOTH REPLACEMENT
- 24 pcs: 12" x 72" with 3" slit & 1" Loop
- 48 pcs: 12" x 80" with 3" slit & 1" Loop

| PRICE | PART# | COLOR |
|-------------------|-----------|-------|
| \$1,514.49 | UBCM313BL | Blue |
| \$1,514.49 | UBCM313BK | Black |
| \$1,514.49 | UBCM313R | Red |
| \$1,514.49 | UBCM313G | Green |

**MC08 WASH-ALONG
MITTER**
CLOTH REPLACEMENT FOR PECO

**LOOPED
& SEWN**

- CLOTH REPLACEMENT
- 64 pcs: 9" x 78" with 3" slit & 1" Loop

| PRICE | PART# | COLOR |
|-------------------|-----------|-------|
| \$1,091.53 | UBCM333BL | Blue |
| \$1,091.53 | UBCM333BK | Black |
| \$1,091.53 | UBCM333R | Red |
| \$1,091.53 | UBCM333G | Green |

**MC35
WASH-A-DIAGONAL
MITTER**
CLOTH REPLACEMENT FOR PECO

**LOOPED
& SEWN**

- CLOTH REPLACEMENT
- 16 pcs: 9" x 78" with 3" slit & 1" Loop
- 24 pcs: 12" x 80" with 3" slit & 1" Loop

| PRICE | PART# | COLOR |
|-----------------|-----------|-------|
| \$791.36 | UBCM343BL | Blue |
| \$791.36 | UBCM343BK | Black |
| \$791.36 | UBCM343R | Red |
| \$791.36 | UBCM343G | Green |

REPLACEMENT CLOTH - SONNY'S® MITTERS

FOAM AND CLOTH AVAILABLE IN THE FOLLOWING COLORS: ● ● ● ●

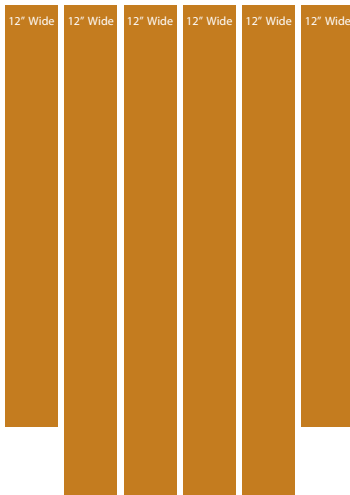

SFM100 & 104 FRONT TO BACK MITTER 6 BASKET LENGTH

CLOTH REPLACEMENT FOR SONNY'S

• CLOTH REPLACEMENT

- 24 pcs: 12" x 76" with 3" slit
- 48 pcs: 12" x 94" with 3" slit

**LOOPED
& SEWN**

| PRICE | PART# | COLOR |
|-------------------|------------------|-------|
| \$1,637.28 | UBCM503BL | Blue |
| \$1,637.28 | UBCM503BK | Black |
| \$1,637.28 | UBCM503R | Red |
| \$1,637.28 | UBCM503G | Green |

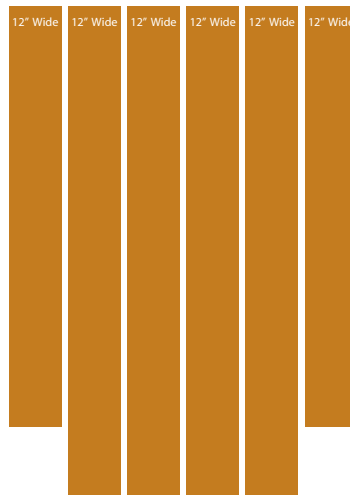

SFM100 & 104 FRONT TO BACK MITTER 4 BASKET VAN LENGTH

CLOTH REPLACEMENT FOR SONNY'S

• CLOTH REPLACEMENT

- 16 pcs: 12" x 76" with 3" slit
- 32 pcs: 12" x 94" with 3" slit

**LOOPED
& SEWN**

| PRICE | PART# | COLOR |
|-------------------|------------------|-------|
| \$1,141.55 | UBCM533BL | Blue |
| \$1,141.55 | UBCM533BK | Black |
| \$1,141.55 | UBCM533R | Red |
| \$1,141.55 | UBCM533G | Green |

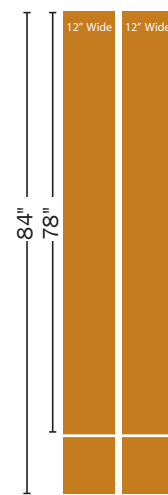

SFM801 SIDE TO SIDE MITTER 1" WIDE BASKET VAN LENGTH

CLOTH REPLACEMENT FOR SONNY'S

• CLOTH REPLACEMENT

- 16 pcs: 12" x 78" with 3" slit
- 16 pcs: 12" x 84" with 3" slit

**LOOPED
& SEWN**

| PRICE | PART# | COLOR |
|-----------------|------------------|-------|
| \$710.63 | UBCM513BL | Blue |
| \$710.63 | UBCM513BK | Black |
| \$710.63 | UBCM513R | Red |
| \$710.63 | UBCM513G | Green |

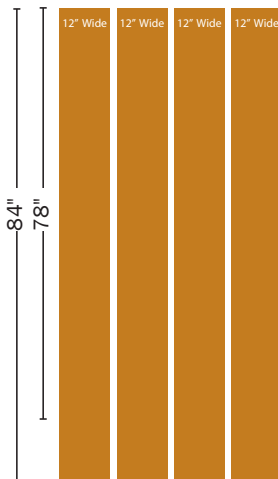

SFM802 SIDE TO SIDE MITTER 2' WIDE BASKET VAN LENGTH

CLOTH REPLACEMENT FOR SONNY'S

• CLOTH REPLACEMENT

- 32 pcs: 12" x 78" with 3" slit
- 32 pcs: 12" x 84" with 3" slit

**LOOPED
& SEWN**

| PRICE | PART# | COLOR |
|-------------------|------------------|-------|
| \$1,400.78 | UBCM543BL | Blue |
| \$1,400.78 | UBCM543BK | Black |
| \$1,400.78 | UBCM543R | Red |
| \$1,400.78 | UBCM543G | Green |

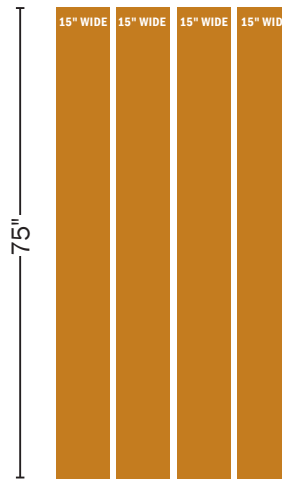

SFM202 MITTER FRONT TO BACK CURVED BASKET VAN LENGTH

CLOTH REPLACEMENT FOR SONNY'S

• CLOTH REPLACEMENT

- 42 pcs: 15" x 75" with 3" slit

**LOOPED
& SEWN**

| PRICE | PART# | COLOR |
|-------------------|------------------|-------|
| \$1,080.14 | UBCM523BL | Blue |
| \$1,080.14 | UBCM523BK | Black |
| \$1,080.14 | UBCM523R | Red |
| \$1,080.14 | UBCM523G | Green |

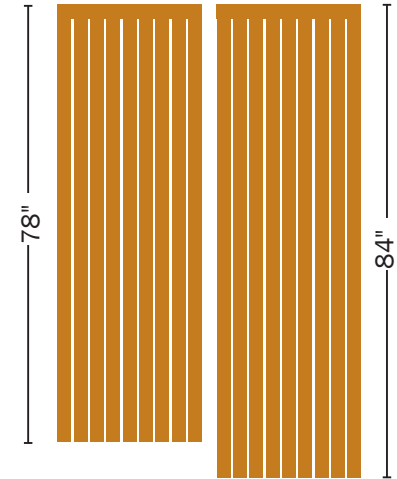

SFM804 MITTER SIDE TO SIDE CURVED BASKET VAN LENGTH

CLOTH REPLACEMENT FOR SONNY'S

• CLOTH REPLACEMENT

- 14 pcs: 18" x 78" with 3" slit
- 14 pcs: 18" x 84" with 3" slit

**LOOPED
& SEWN**

| PRICE | PART# | COLOR |
|-----------------|------------------|-------|
| \$966.45 | UBCM553BL | Blue |
| \$966.45 | UBCM553BK | Black |
| \$966.45 | UBCM553R | Red |
| \$966.45 | UBCM553G | Green |

AUTOMATICS & TUNNELS

FOAM & CLOTHS

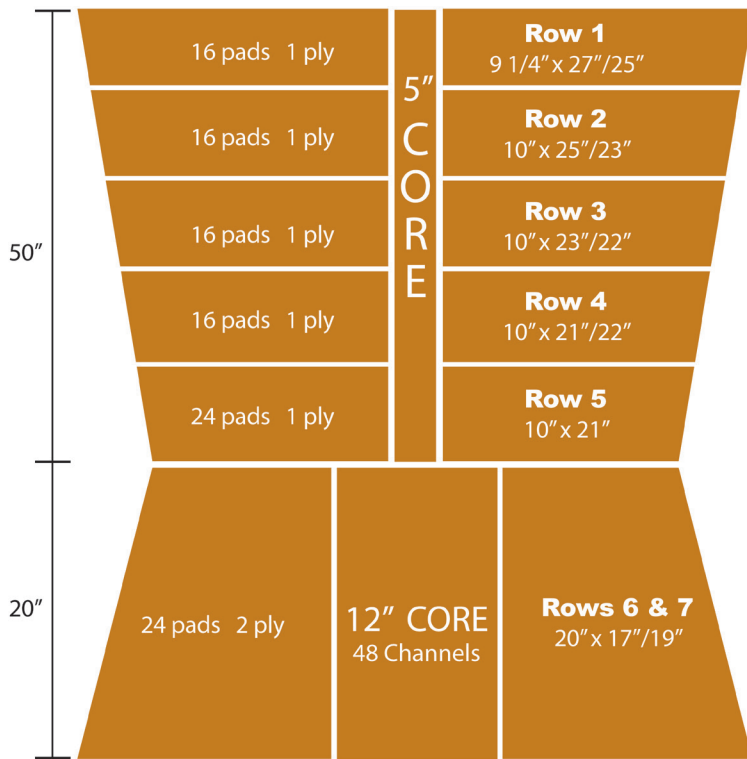

Double Stitched and Reinforced Top

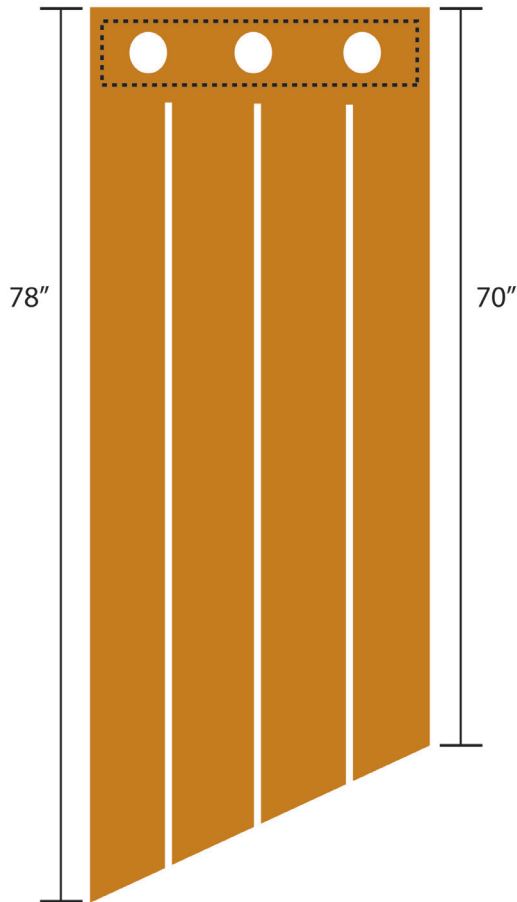

FOAM REPLACEMENTS FOR ATEC® BRUSHES & CURTAINS

FOAM AND CLOTH AVAILABLE IN THE FOLLOWING COLORS: ● ● ● ●

COMPLETE REPLACEMENT SET FOR 4 BRUSHES & CURTAINS

FOAM REPLACEMENT FOR ATEC

• A COMPLETE REPLACEMENT SET FOR 4 BRUSHES & CURTAINS REQUIRES THE FOLLOWING:

- 56 pcs: Row 1
- 56 pcs: Row 2
- 56 pcs: Row 3
- 56 pcs: Row 4
- 96 pcs: Row 5
- 96 pcs: Row 6 & 7
- 44 pcs: Curtains

• OR CHOOSE SINGLE REPLACEMENTS FROM CHART BELOW

| ROW | SIZE | COLOR | PART # | PRICE |
|-------|-----------------------------------|-------|----------|---------------------|
| 1 | 9 1/4" x 27"/25" Taper Trim Foam | Blue | UBF600BL | \$13.36 EACH |
| | | Red | UBF600R | |
| | | Black | UBF600BK | |
| | | Green | UBF600G | |
| 2 | 10" x 25"/23 1/2" Taper Trim Foam | Blue | UBF605BL | \$12.79 EACH |
| | | Red | UBF605R | |
| | | Black | UBF605BK | |
| 3 | 10" x 23.5"/22" Taper Trim Foam | Blue | UBF610BL | \$12.51 EACH |
| | | Red | UBF610R | |
| | | Black | UBF610BK | |
| | | Green | UBF610G | |
| 4 | 10" x 22"/21" Taper Trim Foam | Blue | UBF615BL | \$11.93 EACH |
| | | Red | UBF615R | |
| | | Black | UBF615BK | |
| 5 | 10" x 21" Trim Foam | Blue | UBF620BL | \$11.65 EACH |
| | | Red | UBF620R | |
| | | Black | UBF620BK | |
| | | Green | UBF620G | |
| 6 & 7 | 20" x 17"/20" Taper (2 ply) Foam | Blue | UBF625BL | \$35.25 EACH |
| | | Red | UBF625R | |
| | | Black | UBF625BK | |
| | | Green | UBF625G | |

| | | | | |
|---------|--|-------|----------|---------------------|
| Curtain | 12" x 78"/70" Tapered 3" Slit Drop Cloth | Blue | UBC630BL | \$26.72 EACH |
| | | Red | UBC630R | |
| | | Black | UBC630BK | |
| | | Green | UBC630G | |



AUTOMATICS & TUNNELS

FOAM & CLOTHS

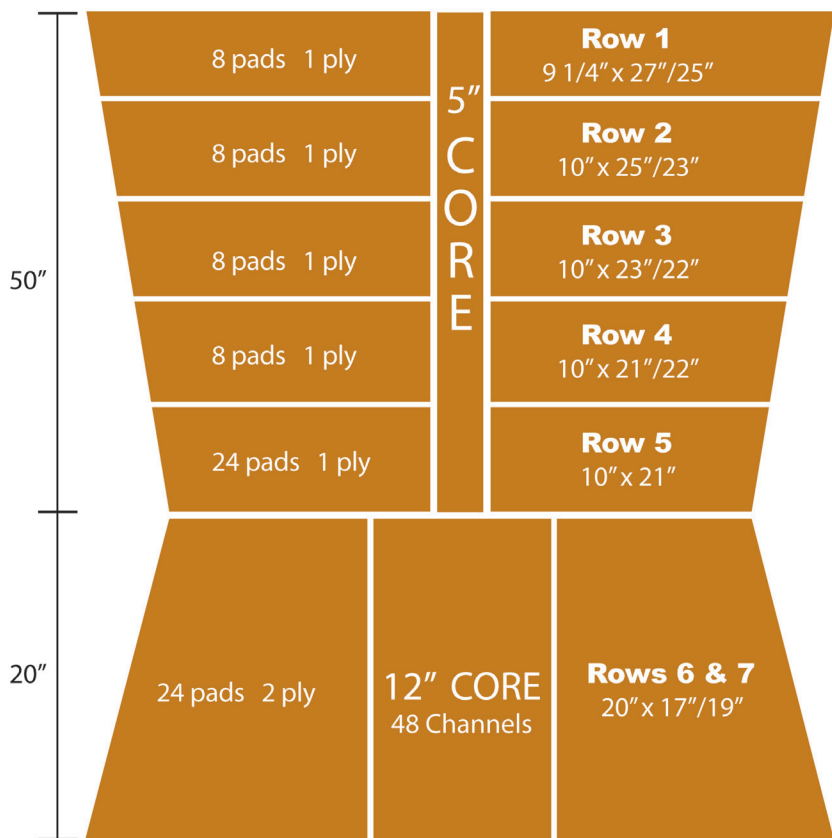

Double Stitched and Reinforced Top

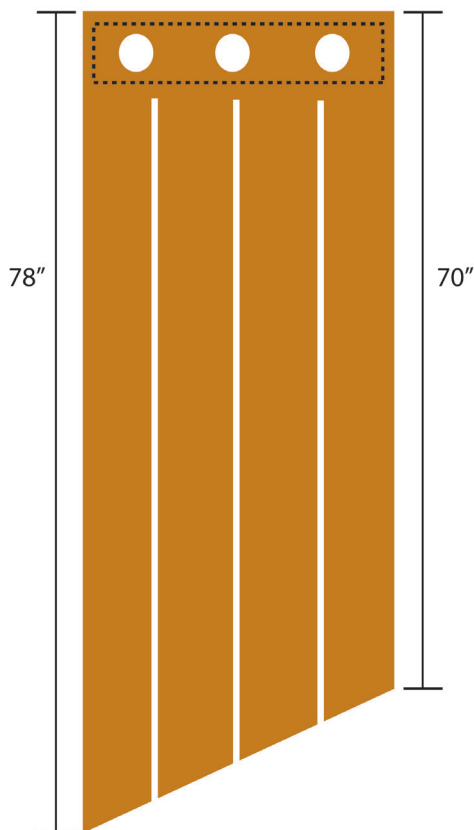

CLOTH REPLACEMENTS FOR AUTEC® BRUSHES & CURTAINS

FOAM AND CLOTH AVAILABLE IN THE FOLLOWING COLORS: ● ● ● ●

COMPLETE REPLACEMENT SET FOR 4 BRUSHES & CURTAINS

CLOTH REPLACEMENT FOR AUTEC

- A COMPLETE REPLACEMENT SET FOR 4 BRUSHES & CURTAINS REQUIRES THE FOLLOWING:
 - 32 pcs: Row 1
 - 32 pcs: Row 2
 - 32 pcs: Row 3
 - 32 pcs: Row 4
 - 96 pcs: Row 5
 - 96 pcs: Row 6 & 7
 - 44 pcs: Curtains
 - 96 pcs: Buffers
- OR CHOOSE SINGLE REPLACEMENTS FROM CHART BELOW

| ROW | SIZE | COLOR | PART # | PRICE |
|-------|---------------------------------------|-------|----------|------------------------|
| 1 | 9 1/4" x 27"/25" Taper Trim Cloth | Blue | UBC600BL | \$9.66 EACH |
| | | Red | UBC600R | |
| | | Black | UBC600BK | |
| | | Green | UBC600G | |
| 2 | 10" x 25"/23 1/2" Taper Trim Cloth | Blue | UBC605BL | \$9.26 EACH |
| | | Red | UBC605R | |
| | | Black | UBC605BK | |
| | | Green | UBC605G | |
| 3 | 10" x 23 1/2"/22" Taper Trim Cloth | Blue | UBC610BL | \$8.93 EACH |
| | | Red | UBC610R | |
| | | Black | UBC610BK | |
| | | Green | UBC610G | |
| 4 | 10" x 22"/21" Taper Trim Cloth | Blue | UBC615BL | \$8.63 EACH |
| | | Red | UBC615R | |
| | | Black | UBC615BK | |
| | | Green | UBC615G | |
| 5 | 10" x 21" Trim Cloth | Blue | UBC620BL | \$8.40 EACH |
| | | Red | UBC620R | |
| | | Black | UBC620BK | |
| | | Green | UBC620G | |
| 6 & 7 | 20" x 17"/20" Taper (2 ply) Cloth | Blue | UBC625BL | \$25.58 EACH |
| | | Red | UBC625R | |
| | | Black | UBC625BK | |
| | | Green | UBC625G | |

| | | | | |
|---------|---|-------|----------|------------------------|
| Curtain | 12" x 78"/70" Tapered 3" Slit Drop Cloth | Blue | UBC630BL | \$26.72 EACH |
| | | Red | UBC630R | |
| | | Black | UBC630BK | |
| | | Green | UBC630G | |

| | | | | |
|--------|------------------|-------|----------|-----------------------|
| Buffer | 20" x 5" (2 ply) | Blue | UBC635BL | \$8.52 EACH |
| | | Red | UBC635R | |
| | | Black | UBC635BK | |
| | | Green | UBC635G | |

