

SWIVELS



STRAIGHT SWIVEL

SWIVELS BY J.E. ADAMS



- Stainless steel insert
- Repairable
- Swivels under pressure
- 200°F Temp. rating

PRICE	PART#	SIZE	PSI	PRICE	PART#	SIZE	PSI
\$13.30	SW7045	3/8F x F Brass	3000	\$20.39	SW7470	1/4M x F SS HP	5000
\$12.75	SW7070	3/8M x 1/4 F Brass	3000	\$17.25	SW7044	3/8M x F SS	5000
\$12.79	SW7080	3/8M x F Brass	3000				
\$13.08	SW7480	1/4M x F Brass	3000				

STRAIGHT SWIVEL REPAIR KITS

SWIVELS

PRICE	PART#	DESCRIPTION	PRICE	PART#	DESCRIPTION
\$5.61	SW7080K	Repair kit - SW7044/7080	\$4.15	SW7480K	Repair kit - 7480/7470/7070

BALL BEARING SWIVEL

FLUID CONTROLS

FLUID CONTROLS

- High-pressure swivel with brass body & stainless steel thrust bearings. Internally lubricated O-rings & SS center spool piece
- Max. Temperature: 160°F
- An economical choice for high-pressure wash applications. Built to last for reliable service
- Helps facilitate trouble-free operation at your wash

PRICE	PART#	SIZE	PSI	PRICE	PART#	SIZE	PSI
\$18.91	SW0140	1/4" F x M Brass	2000	\$21.75	SW0265	3/8" F x M Brass	3500
\$21.29	SW0145	1/4" M x F Brass	3500	\$36.42	SW0270	3/8" F x F Ball Bearing	3500
\$17.44	SW0260	3/8" F x M Brass	2000				

BALL BEARING SWIVEL REPAIR KITS

FLUID CONTROLS

PRICE	PART#	DESCRIPTION
\$7.46	SW0260K	Repair Kit 1/4" & 3/8"

These swivels from Fluid Controls are field repairable in minutes with the repair kit listed here. Avoid downtime by keeping repair kits on hand!

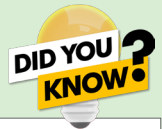

Buy our 5 pack of the best-selling **SW0260** in bulk and save!



2000 PSI BRASS SWIVEL KLEEN-RITE KITS

- Kit contains: (5) 3/8" M x F brass swivels

\$86.49 SW0260-5

ECONOMY LOW PRESSURE SWIVEL

BRASS SWIVEL

- 1000 PSI
- Non-Repairable

PRICE	PART#	SIZE
\$4.29	SW0250	3/8" M x 3/8" F
\$9.36	SW0255	3/8" M x 1/4" F
\$13.60	SW0258	1/2" M x 1/2" F



1000 PSI BRASS SWIVEL KLEEN-RITE KITS

- Kit contains: (5) 3/8" M x F brass swivels

\$18.30 SW0250-5

ECONOMY LOW PRESSURE SWIVEL

KLEEN-RITE CORP.

- 1000 PSI | 3/8" M x F

\$5.91 SWE100



BRASS HOSE REEL SWIVEL

J.E. ADAMS



- 3000 PSI | 10 GPM | 1/2" FPT | 300°F

\$38.88	SW7475	Swivel
\$11.75	SW7475K	Repair Kit

SWIVELS

SELF-SERVE SWIVELS

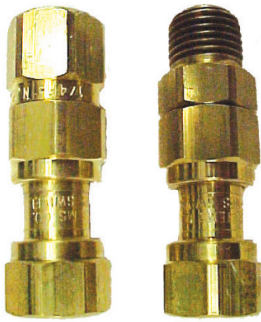

BREAK-AWAY SWIVEL

SPRAYING SYSTEMS CO.

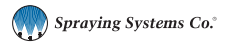

- They will prolong hose life by preventing kinking of hose as well as reducing operator fatigue
- Recommended for intermittent, non-continuous swivel requirements
- Flow is bi-directional • Max. temperature is 180° F • Brass construction • Provides leakproof connections

\$14.47	SW0205	3/8" F x F Brass	\$10.88	SW0100	1/4" F x M Brass
\$5.49	SW0205K	Repair Kit 3/8"	\$10.88	SW0105	1/4" F x F Brass
\$23.16	SW0300	1/2" F x M Brass	\$5.60	SW0105K	Repair Kit 1/4"
\$23.16	SW0305	1/2" F x F Brass	\$14.47	SW0200	3/8" F x M Brass



90° BOOM SWIVEL

SPRAYING SYSTEMS CO.

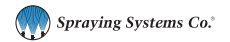

- Pressure loading of swivel is balanced so that it will swivel easily at all pressures up to 2000 PSI.
- Rated to temperatures up to 200° F. Nickel-plated brass construction with Buna O-rings and Delrin bearings.

\$35.49	SWKR690	3/8" M x F
\$3.28	SWKR690K	Repair Kit



STRAIGHT SWIVEL

SPRAYING SYSTEMS CO.

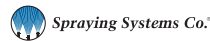

- Brass Max PSI: 1000 | Stainless Max PSI: 3000
- Stainless steel or brass construction
- Bearings are self-lubricated Teflon filled acetal for long life and low torque requirements
- **MAX TEMP:** 200°F

\$69.91	SW0215	3/8" M x F Stainless Steel
\$16.75	SW0215K	Repair Kit 3/8" SS
\$43.03	SW0230	3/8" M x F Brass



HIGH PRESSURE SWIVEL

SUTTNER



- High-pressure swivel
- Chrome-plated, brass with stainless steel internals
- 3/8" F x F, or 3/8" M x F • **MAX. TEMP.:** 300°F
- **MAX PRESSURE:** 3000 PSI • **FLOW:** 5 GPM

\$17.26	SUT300FF	3/8" F x F
\$15.42	SUT300MF	3/8" M x F

AUTOMATIC SWIVELS



BIG BOY

ROLLER BEARING SWIVELS

- For tough applications like touchless automatics or high-pressure hose reels. BBS580 Series Swivels are designed for high speed, high torque automatics such as Hydro Spray.

PRICE	PART#	SIZE	PRICE	PART#	SIZE
\$210.78	BBS580	1/2" M x 1/2" F Brass	\$213.48	BBS580C	3/4" M x 3/4" F Brass
\$210.78	BBS580A	1/2" M x 3/4" F Brass	\$210.99	BBS580CSS	3/4" M x 3/4" F SS
\$201.71	BBS580ASS	1/2" M x 3/4" F SS	\$202.53	BBS580SS	1/2" M x 1/2" F SS

USE THESE KITS
TO REBUILD
YOUR SWIVELS

BEARING REPLACEMENT KIT

FITS ALL BIG BOY SWIVELS

- **CONTAINS:** • (2) Roller Bearings • (2) Races

CALL **BBRBRK**

BASIC RE-SEAL KIT

FITS ALL BIG BOY SWIVELS

- **CONTAINS:** • (2) O-Rings Internal Lubrication • (2) Back O-Rings • (1) Instruction Sheet

CALL **BBORRK**

DO NOT OVERGREASE SWIVELS. DO NOT USE ANY GREASE THAT CONTAINS GRAPHITE OR MOLYBDENUM



INLINE SWIVEL

PARKER



\$76.70	SWP06	3/8" F x F
----------------	--------------	------------

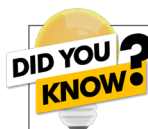

PARKER® PS Series swivels are designed to eliminate hose twist and torque that may cause premature hose failure. These swivels have a full flow, sealed bearing design with hardened bearing races that are resistant to side load and are suitable for high pressure. PS Series swivels are available in 90° and in-line configurations with a wide variety of port ends, making them ideal for an array of dynamic applications.

GUN SWIVELS



4000 PSI LIVE GUN SWIVEL MOSMATIC



- It is well known that Mosmatic swivels turn freely even under high pressure.
- Made of corrosion resistant material and stainless steel self-lubricating bearings, the new gun swivel offers the highest quality Swiss made craftsmanship.

PRICE	PART #	SIZE
CALL	SWM32552	1/4" M x 1/4" F
	SWM32561	3/8" M x 1/4" M
	SWM32562	3/8" M x 1/4" F

PRICE	PART #	SIZE
CALL	SWM32563	3/8" M x 3/8" M
	SWM32564	3/8" M x 3/8" F
	SWM32569	3/8" F x 3/8" F
	SWM32864	1/2" M x 1/2" F

STRAIGHT SWIVEL MOSMATIC



- Dual Bearing System • Live Under Pressure • Multiple Seals System • Maintenance Free • 4000 PSI

PRICE	PART#	SIZE
CALL	SWM30051	1/4" F x M
	SWM30052	1/4" F x F
	SWM30153	3/8" M x F
	SWM30154	3/8" F x F

PRICE	PART#	SIZE
CALL	SWM30053	3/8" M x 1/4" F
	SWM30054	1/4" F x 3/8" F
	SWM30014	G1/4" x 3/8" FNPT Old Style
	SWM30654	3/8" F x F New Style



BALL BEARING SWIVEL THE SPECIALTY MFG. CO.

THE SPECIALTY MFG. CO.
Custom to Our Specialty

- Ball bearing swivels are of electroless nickel-plated brass construction. Cap ends are precision machined for heavy-duty leak proof service. High-pressure seal is Teflon backed Buna-N. Bearing seal is vented between the high-pressure seal.
- Max Pressure: 1500 PSI, Liquid 250 PSI Air

PRICE	PART #	SIZE
\$21.90	SW0120	1/4" M x F
\$21.90	SW0125	1/4" F x F
\$22.71	SW0240	3/8" M x F

PRICE	PART #	SIZE
\$22.71	SW0245	3/8" F x F
\$14.12	SW0245K	Kit for 1/4" & 3/8"
\$22.71	SW0241	3/8" M x 1/4" F



SONIC SWIVEL

- Nickel plated brass with stainless steel ball bearings

PRICE	PART#	SIZE
\$29.25	SON38MF	3/8" M x F
\$39.50	SON38MFN	90° 3/8" M x F
\$29.25	SON14MF	1/4" M x F

PRICE	PART#	DESCRIPTION
\$4.99	SONKIT	Repair Kit for 3/8" & 1/4" 90°

SWIVELS



90° BOOM SWIVEL KLEEN-RITE SWIVEL

KLEEN-RITE CORP.

- Use wherever hose moves or twists • Low torque • Sealed against dust
- Long-life seal • 360° swivel action • 300° F temp. rating • Viton O-rings

PRICE	PART#	SIZE	PRESSURE / FLOW
\$26.82	SW4000	3/8" M x F	3000 PSI/7 GPM
\$11.97	SW4000KN	NEW STYLE Repair Kit 3/8" M x F For Swivel w/ Groove	
\$35.54	SW4000SS	3/8" STAINLESS	5000 PSI/7 GPM

SWIVELS

SWIVELS



SHORT NIPPLE



LONG NIPPLE

90° BOOM REPLACEMENT SWIVELS

MOSMATIC



CALL	SWM40009 (Old Style Boom)	G 1/4" F x G 1/4" M	4000 PSI
	SWM40019* (New Style Boom)	G 1/4" F x 3/8" FNPT	4000 PSI

***SWMK90N IS THE SEAL KIT FOR SWM40019**

90° BOOM SWIVEL

MOSMATIC



- Multiple seal system for both low and high pressure prevents leakage
- Totally corrosion-resistant version ensures longevity
- Compact and lightweight
- Easy installation

PRICE	PART#	SIZE	NIPPLE SIZE	PRESSURE
CALL	SWM40022	3/8" F x 1/4" M	Short	2200 PSI
	SWM40029	3/8" F x 1/4" M	Long	2200 PSI
	SWM40021**	1/4" F x M	Short	2200 PSI
	SWM40032	3/8" F x M	Short	2200 PSI
	SWM40031**	1/4" F x 3/8" M	Short	2200 PSI
	SWM40028	1/4" F x M	Long	2200 PSI
	SWM40039	3/8" F x M	Long	2200 PSI
	SWMK90	Kit for 90° Style Without Washer		
	SWMK90N	Kit for 90° Style With Washers		

****NOT FOR USE WITH MOSMATIC BOOMS**



BRASS BALL BEARING SWIVEL

VALUE LINE



- 3/8" M x F

\$14.55 SWV500



STRAIGHT SWIVEL

VALUE LINE



- 3/8" M x F

\$9.99 SWV38SS Stainless Steel
\$7.48 SWV38 Brass

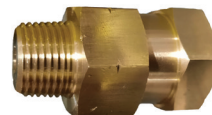

INLINE SWIVEL

PRICE	PART#	HOSE X MPT
\$7.58	HF0120	1/4" x 1/4"
\$8.99	HF0121	3/8" x 3/8"
\$9.94	HF0122	3/8" x 1/2"
\$10.95	HF0123	1/2" x 1/2"
\$9.54	HF0127	1/2" x 3/8"

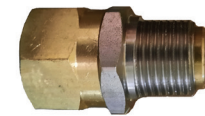

3/8" M x F SWIVEL

U.S. PARA PLATE



\$15.64 SW0290 Brass
\$25.50 SW0290SS Stainless Steel

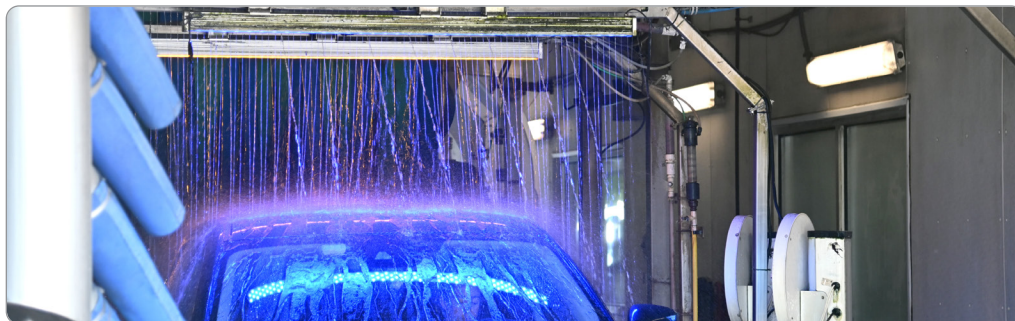

SWIVELS



3/8" M x F SWIVEL DEUBLIN



- 90° (radial) hose connection
- 3000 PSI / 250°F
- Nickel-plated rotor and housing

PRICE	KR #	MFG. #
\$165.25	SW1500	17-058-056



3/4" M x F SWIVEL DEUBLIN



- 90° (radial) hose connection
- 3000 PSI / 250°F
- Nickel-plated rotor and housing

PRICE	KR #	MFG. #
\$269.55	SW1600	21-040-101



3/4" NPT SWIVEL DEUBLIN



- 90° (radial) hose connection
- **MAXIMUM HOT OIL PRESSURE:** 100 PSI
- **MAXIMUM STEAM PRESSURE:** 15 PSI
- **MAXIMUM WATER GLYCOL PRESSURE:** 750 PSI
- **MAXIMUM WATER PRESSURE:** 750 PSI
- 1500 RPM / 250°F
- **TORQUE RATING:** 0.5 foot pounds
- **STAINLESS STEEL ROTOR:** 3/4" NPT RH thread

PRICE	KR #	MFG. #
\$270.19	SW1700	255-324-976



3/4" F x F SWIVEL DEUBLIN



- 90° (radial) hose connection
- 3000 PSI / 250°F
- Nickel-plated rotor and housing

PRICE	KR #	MFG. #
\$233.13	SW1630	21-060-000

90° BOOM SWIVEL THE SPECIALTY MFG. CO.

THE SPECIALTY MFG. CO.
Custom Is Our Specialty



- 11½ GPM
- 3/8" M x 3/8" F connection
- Stainless Stem
- 1500 PSI Max pressure
- Brass Body

PRICE	SW	DESCRIPTION
\$28.19	SW3800	90° Boom Swivel
\$7.59	SW3800K	Repair Kit



90° BOOM SWIVEL FLUID CONTROLS

FLUID CONTROLS

- Brass construction with stainless steel precision thrust bearings
- Excellent for hose reels & overhead booms
- Repairable
- Swivels effortlessly

PRICE	PART#	DESCRIPTION
\$33.85	SW0273	1/4" M x F Brass BB - 3500 PSI
\$34.18	SW0275	3/8" M x F Brass BB - 2000 PSI
\$7.46	SW0260K	Repair Kit for 1/4" & 3/8"

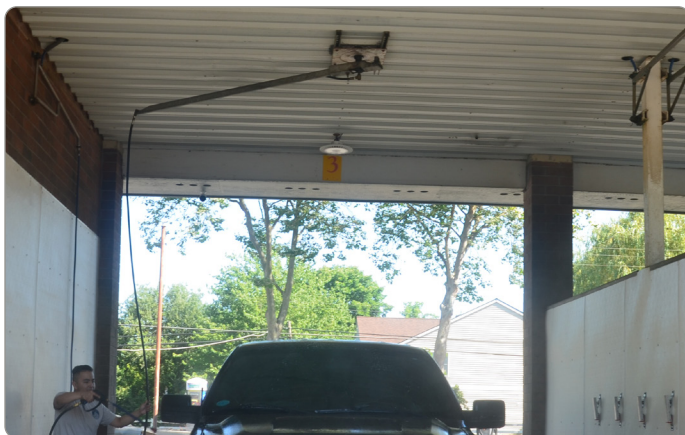

90° BOOM SWIVEL VALUE LINE



- Use wherever hose moves or twists
- Sealed against dust
- 360° swivel action
- Viton O-rings
- 3/8" M x 3/8" F
- 7 GPM
- Long-life seal
- 300° F temp. rating
- Low torque
- 3000 PSI Max Pressure

PRICE	SW
\$19.04	SWV520

SWIVELS

SWIVELS



90° HIGH PRESSURE SWIVELS

SUPER SWIVELS

- Ideal selection for use as replacement swivels on automatic car washes, hose reels and ceiling booms
- Live swivel ball bearing design
- Maximum temperature is 400°F
- Rebuildable
- Ideal for use with hot water, hydraulic fluid, insecticides, etc.
- Nickel plated alloy steel
- 5000 PSI



1" F x F
SUPER SWIVELS

\$92.79	SWS1690FF	1" F x F
\$13.81	SWS16K	Repair Kit



1" M x F
SUPER SWIVELS

\$92.79	SWS1690	1" M x F
\$13.81	SWS16K	Repair Kit



1" NPTF x 1" NPTF
90° EXTENDED SWIVEL
SUPER SWIVELS

- 2.18" diameter body
- 1.625" wrench hex
- 4000 PSI maximum
- 0.827" through hole
- Nickel plated construction

\$143.12	SWS1602
-----------------	----------------



3/4" M x F
SUPER SWIVELS

\$74.71	SWS1290	3/4" M x F
\$9.59	SWS1290K	Repair Kit



3/4" F x F
SUPER SWIVELS

\$74.71	SWS1290FF	3/4" F x F
\$9.59	SWS1290K	Repair Kit



1/4" M x F
SUPER SWIVELS

\$52.30	SWS0490	1/4" M x F
\$8.09	SWS0490K	Repair Kit



1/2" M x F
SUPER SWIVELS

\$53.03	SWS0890	1/2" M x F
\$9.33	SWS0690K	Repair Kit



1/2" F x F
SUPER SWIVELS

\$53.03	SWS0890FF	1/2" F x F
\$9.33	SWS0690K	Repair Kit



3/8" M x F
SUPER SWIVELS

\$53.03	SWS0690	3/8" M x F
\$9.33	SWS0690K	Repair Kit

DOUBLE BEARING SWIVELS

SUPER SWIVELS



- Live swivel ball bearing design
- Rebuildable
- Maximum temperature is 400°F
- Nickel plated alloy steel
- Ideal for use with hot water, hydraulic fluid, insecticides, etc.
- 5000 PSI

90° DOUBLE BEARING SWIVELS

INLINE DOUBLE BEARING SWIVELS

WITH
GREASE
RELIEF
VALVE



1" F x F
SUPER SWIVELS

\$112.26	SWSD169FF	1" F x F
\$16.28	SWSD16K	Repair Kit

WITH
GREASE
RELIEF
VALVE



1" F x F
SUPER SWIVELS

\$103.14	SWSD16FF	1" F x F
\$16.28	SWSD16K	Repair Kit

WITH
GREASE
RELIEF
VALVE



1/2" M x F
SUPER SWIVELS

\$66.58	SWSD89MFG	1/2" M x F
\$13.20	SWSD80K	Repair Kit



1/2" M x F
SUPER SWIVELS

\$66.57	SWSD8MF	1/2" M x F
\$13.20	SWSD80K	Repair Kit



1" F x F PIPE "EXTENDED"
STRAIGHT SWIVEL
SUPER SWIVELS

- Double bearing
- Nickel plated carbon steel

\$140.32	SWSD1601	1" F x F
-----------------	-----------------	----------

SWIVELS



90° HIGH PRESSURE SWIVEL

SUPER SWIVELS



- Used in popular brand automatics
- 3500 PSI

\$192.94	SWS08MF	1/2" M x F
\$45.06	SWS0890SK	Repair Kit



90° HIGH BALANCE SWIVEL

SUPER SWIVELS



- 2000 PSI

\$218.01	SWS082	1/2" M x F
\$218.01	SWS12	3/4" M x F
\$48.37	SWS20198	Repair Kit (w/o bearings)
\$64.37	SWS20197	Repair Kit (w/ bearings)



90° HIGH PRESSURE SWIVEL

SUPER SWIVELS



- Used in popular brand automatics like Hydro-Spray
- 3000 PSI

\$89.09	SWS1290HS	3/4" M x F
\$9.59	SWS1290K	Repair Kit



90° SHAFTED SWIVEL

3/4" M x F

SUPER SWIVELS



- Used in popular brand automatics
- Slotted drive shaft
- 3000 PSI

\$252.39	SWS1290SS	3/4" M x F
-----------------	------------------	------------



INLINE SWIVEL

SUPER SWIVELS



- This high-pressure swivel has chrome ball bearing design for added life
- Easily rebuildable, superior quality alloy steel
- Burnished (micro smooth) barrel bores
- 5000 PSI

\$47.24	SWS04MF	1/4" M x F
\$48.88	SWS06	3/8" F x F
\$48.88	SWS06MF	3/8" M x F
\$51.73	SWS08	1/2" F x F
\$64.81	SWS12MF	3/4" M x F
\$88.21	SWS16MF	1" M x F



90° SHAFTED SWIVEL

1/2" M x F

SUPER SWIVELS



- Slotted drive shaft
- Used in popular brand automatics
- 1500 PSI

\$217.78	SWS0890S	1/2" M x F
\$45.06	SWS0890SK	Repair Kit

SUPER SWIVELS® WAS ESTABLISHED IN 1986 AND IS A LEADER IN THE DESIGN AND MANUFACTURING OF HYDRAULIC LIVE SWIVELS.

Super Swivels uses a heat treating process that allows for a higher working pressure rating. These superior quality, heavy-duty, leak free live swivels are sure to get the job done. Available in several materials, plating options and a wide variety of seal options.

SWIVELS

MOSMATIC AUTOMATIC CAR WASH SWIVEL CONVERSIONS



KLEEN-RITE RECOMMENDED

90° SWIVEL FOR D&S 5000, AUTEK, JIM COLEMAN

MOSMATIC



- WDBL-10
- 3/8" NPTF - 3/8" NPTM

CALL SWM43262

New!



STAINLESS STEEL CLEANING HEAD SPIDER

MOSMATIC



- Features reinforced self-lubricating ball bearings and a long-lasting carbon seal system
 - 2500 PSI maximum pressure
 - 1" FNPT inlet
 - 250° Fahrenheit maximum pressure
- Includes: (1) High RPM Swivel (39.905)
(1) 4s4 Rotor Arm (88.796)
(4) Stabilizer Nozzles (14.933)

CALL SWMTA81944



90° SWIVEL FOR HYDRO-SPRAY, RAINMAKER, AVW, SOUTHERN PRIDE

MOSMATIC



- Hi Flo
- WDRL-13
- 1/2" NPTF - 1/2" NPTM

CALL SWM41261



90° HIGH FLOW DGE ROTARY UNION FOR PDQ

MOSMATIC



- Hi Flo
- Nickel-plated brass with stainless steel inner parts
- 1" NPTF

CALL SWM34885



90° SWIVEL FOR COBRA, ECONOCRAFT MARK VII AQUA JET, OASIS

MOSMATIC



- Hi Flo WDR
- 1/2" NPTM - 5/8" Motor Shaft M Inox

CALL SWM41920

New!



90° DEGREE WDS SWIVEL

MOSMATIC



- For the PDQ Laserwash G5 vehicle wash system
- Great for in-bay automatics and tunnel washes

CALL SWM40936



AUTEK MOSMATIC



- WDRS 3/4" NPTFx F
- 3/4" Motor
- Gear Driven

CALL SWM41922



T-BAR FOR N/S QUADRA, RAINMAKER CLASSIC

MOSMATIC



- T-Bar Diameter 24: -24" TUA-4h4, G3/8" F, 4 Arms, 4 Nozzle Outlets 1/8" NPTF

CALL SWMT86911



WASHWORLD BROADWAY PDQ

MOSMATIC



- Swivel Hi Flo DGR4-20
- 1" NPTF - 1" NPTF Inox

CALL SWM34927



90° SWIVEL WDR SERIES

MOSMATIC



- Sealed stainless steel ball bearings and stainless steel corrosion protector plates ensure longevity. The toughest swivel made for the car wash industry.

CALL

SWM41261

1/2" NPT F x M

SWM41361

3/4" NPT F x M

SWM41922

Autek Replacement

MOSMATIC HIGH SPEED SWIVELS



SWIVEL WITH BULKHEAD FITTING
MOSMATIC



CALL	SWM57063	1/4" F x G 3/8" M
	SWM57163	3/8" F x G 3/8" M



SWIVEL WITH MOUNTING FLANGE
MOSMATIC



CALL	SWM58063	1/4" F x G 3/8" M
	SWM58163	3/8" F x G 3/8" M

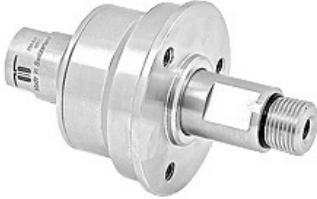

INLINE SWIVEL
MOSMATIC



CALL	SWM55063	1/4" F x G 3/8" M
	SWM55163	3/8" F x G 3/8" M



SWIVEL WITH HD BEARINGS
MOSMATIC



CALL	SWM59163	3/8" F x G 3/8" M
------	----------	-------------------

UNDERCARRIAGE CLEANING SYSTEM
MOSMATIC



New!



- Used in sub-floor and fixed ramp automatic car washes
- Boasts industrial-grade stainless steel plates and boxes with quad bearing swivels and welded rotor arms
- Thoroughly clean a vehicle's underside without causing any damage
- Max Pressure: 4000 PSI
- Max Temp: 250°F
- Max RPM: 2000
- 3/4" NPTF water connection
- 1" NPTF water drain

CALL	UCM80640
------	----------

TURBO-ROTOR ARM
MOSMATIC

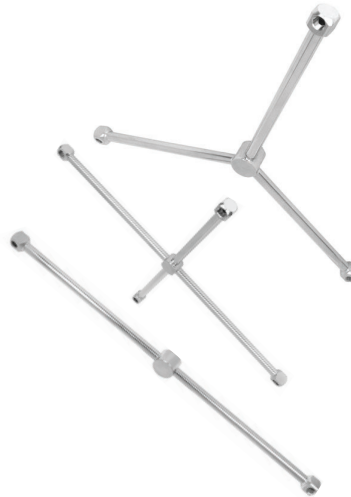

- The turbo rotor arm, in conjunction with a swivel, begins to turn on its own from the water pressure. This product is found mainly in automatic car wash facilities in the area of rim and finish cleaning.

CALL	SWMTA82811	16" Two-Arm
	SWMTA82812	18" Two-Arm
	SWMTA82872	18" Three-Arm
	SWMTA82837	16" Four-Arm

Check out our website for more available sizes

New!



STAINLESS STEEL WHEELBLASTER STAND
MOSMATIC



- Used with Wheelblaster Pro wash heads
- Wash head can be adjusted to any height along the entire stand
- 39" polished stainless steel
- Use with 4"/4" wash heads (part #84.586) and 6"/6" wash heads (part #84.596)

\$195.75	SWMTC903986	Stand
\$907.59	SWMTC84586	Wheel Blaster Pro Head

ROTATION SYSTEM
MOSMATIC



- As the water pressure builds, the rotor arms begin to rotate independently. The arm rotates only by the force of the water jet and requires no other power. A simple but efficient and solid product for a optimal cleaning effect.
- Max Pressure: 5000 PSI • Max. Temp: 250°F • Stab. Nozzle / Adapter (4) 14.901

PRICE	PART #	G1 (F)	NW	ROTARY UNION	ROTOR ARM	INSERT NOZZLE
CALL	SWMT81920	1/4" NPTF	1/4"	DYT (59.063)	4w4 (82.954)	(4 Required) 0004EG*
	SWMT81922	3/8" NPTF	1/4"	DYT (59.163)	4w4 (82.954)	(4 Required) 0004EG*

* NOT INCLUDED

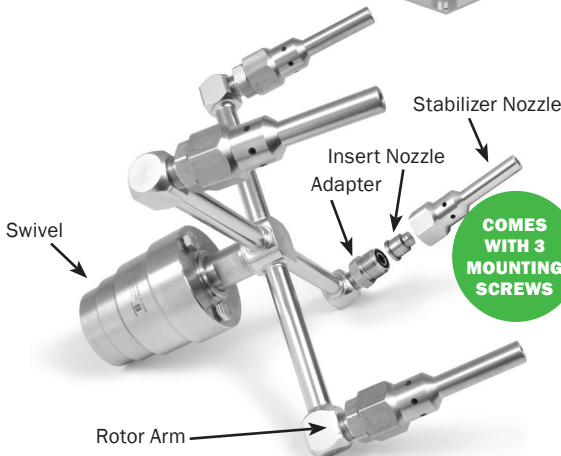

COMES WITH 3 MOUNTING SCREWS