

KLEEN-RITE CORP.

YOUR RELIABLE SUPPLIER FOR THE CAR WASH INDUSTRY



LOCATIONS

MOUNT JOY, PA

LAS VEGAS, NV

KANSAS CITY, MO

GRAND PRAIRIE, TX

860 ANDERSON FERRY RD, PA

(P) 717.684.6721

(F) 800.446.0495

SALES@KLEEN-RITECORP.COM

KLEENRITE.COM

ISSUE 65

[2]

KLEEN-RITE CORP.
YOUR RELIABLE SUPPLIER FOR THE CAR WASH INDUSTRY

Easy Ways To Earn Free Shipping!



Getting free shipping on your orders has never been easier. See below for our 2 programs that let you receive free shipping.

OPTION

[1]

Join Our Rewards Club



Get rewarded for your purchases when you join the FREE Kleen-Rite Rewards Club! Earn points for every dollar that you spend, and redeem for great perks like complimentary shipping and special savings.

How do I sign up for the Kleen-Rite Rewards program?

Your sign up for the Kleen-Rite Rewards program must be completed on www.kleenrite.com. Unfortunately, our sales or customer service reps are unable to sign you up.

What if I already have a web account?

If you already have a Kleen-Rite Web account, you can sign up for the program from the "My Account" page by clicking on the "Join Rewards Program" button.

Can I use my points if I phone in my orders?

Yes, you can. Just tell your sales rep you'd like to use points. They will be able to check and see what points you have and redeem your rewards with your points.

**My Kleen-Rite
Customer # is:**

SIGN UP FOR YOUR REWARDS
ACCOUNT TODAY AT:

www.kleenrite.com

Write it here so you'll have it handy!

OPTION

[2]

Order a Full Pallet of Soap

Free Shipping on a full pallet of soap anywhere in the lower 48 US states.

Must be a full pallet.
Pallet Quantities Are:

Liquid Soap

36	5 Gallon Pails
4	55 Gallon Drums
5	30 Gallon Drums

Powder Soap

36	50lb Boxes
18	100lb Drums

*Kleen-Rite specified carrier only.
Lift Gate Service Included.



Have You Tried the **KR STOCK** App Yet?

We've been busy – check out the updates we've made to this industry-leading app!

Have you checked out KR Stock yet? If you haven't – or you haven't used it recently – you need to check out the great updates we've made to this industry-leading tool!

- **Quick Order:** Quickly look up your products and add them to the cart without having to leave the main catalog screen.
- **Rewards Program Integration:** We make it even easier to get the most out of your relationship with us. Earn when you buy, and use your Rewards right in the app! Why pay for shipping when you can earn it for free as part of the program?
- **Promo Code Integration:** Just like with Rewards program, there are no extra steps for using promo codes – just enter them right there in the app! From Free Shipping codes to other exclusive offers, redeem them right away!
- **Real Time Stock Status:** You can see an up-to-date status on stock availability at Kleen-Rite! See what's in stock – and know if you need to look for alternatives for expedient delivery!

Save time. Save money.

Download the KR Stock app today!

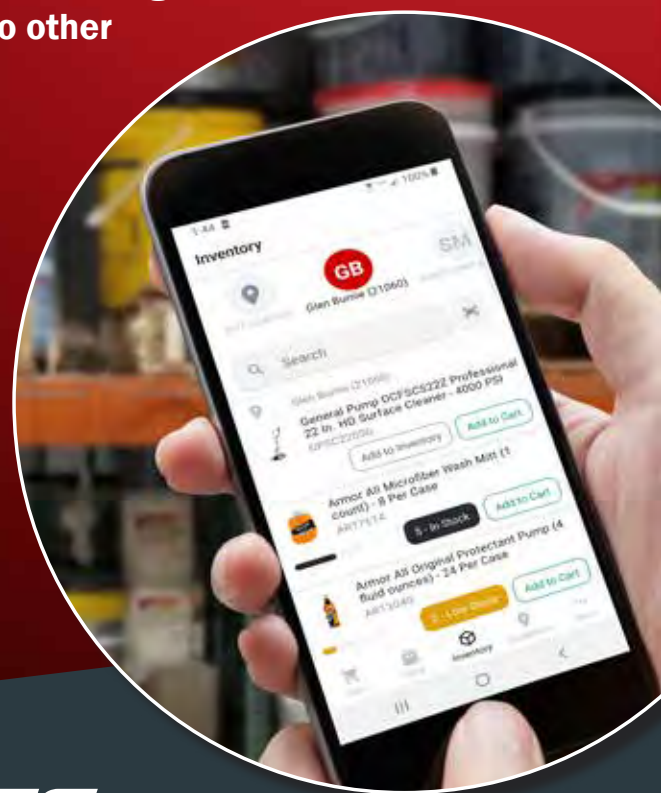

***KLEEN-RITE* CORP.**
YOUR RELIABLE SUPPLIER FOR THE CAR WASH INDUSTRY
KLEENRITE.COM | 800.233.3873

KLEEN-RITE CORP.

YOUR RELIABLE SUPPLIER FOR THE CAR WASH INDUSTRY



CORPORATE OFFICE

257 South 9th Street
Columbia, PA 17512

800-233-3873

SERVING THE CAR WASH INDUSTRY FOR OVER 50 YEARS . . .

Here at Kleen-Rite, we have always operated our own company car wash alongside the supply side of our business, which gives us an operator's insight into the needs, problems and solutions for running a successful car wash. It enables us to have our finger on the pulse of what our customers need. Our car wash has always been Kleen-Rite's test site, as well as our roots. When a new product comes to market, we can put it to the test at the car wash. This helps us understand very quickly why a product works or not, or the struggles and problems inherent in a piece of equipment - because we deal with and understand them firsthand. This inside knowledge enables Kleen-Rite to gain an understanding of an operator's - and their customers' - perspective.

4 LOCATIONS ENABLE US TO GET YOU YOUR NEEDED SUPPLIES & PARTS FAST . . .

We know that running a successful operation includes having a reliable supplier that can deliver you the replacement parts and supplies that you may need as fast as possible. When a piece of equipment fails, you need to get it back in working order as quickly as possible. That's why we have 4 strategically located warehouse locations across the U.S., so we can get your orders out to you fast. Operators across the country have come to rely on our extensive inventory, knowledgeable staff and quick turnaround time. Our goal is to always give you the "Best for Less" and to be "Your Reliable Supplier for the Car Wash Industry!"



TEXAS

1375 114th Street
Grand Prairie, TX 75050



NEVADA

4604 Industry Center Drive
Las Vegas, NV 89115



MISSOURI

5121 E Front Street
Kansas City, MO 64120



PENNSYLVANIA

860 Anderson Ferry Road
Mount Joy, PA 17552

**PICK UP CUSTOMERS:
PLEASE CALL YOUR ORDER IN AHEAD OF TIME SO
IT IS READY FOR PICK-UP WHEN YOU ARRIVE!**

WARNING: This publication is Kleen-Rite Corp. proprietary intellectual property and is protected under United States Copyright Laws. No part of this catalog including all text and graphical information and cover design, may be reproduced or transmitted in any form, by any means (electronic, photocopying, recording, or otherwise) without the prior written permission of a corporate officer of Kleen-Rite Corp. © 2024 Kleen-Rite Corp.



Proposition 65, known as the Safe Drinking Water and Toxic Enforcement Act of 1986, aims to protect drinking water sources and California citizens from exposure to chemicals known to cause cancer, birth defects, or other reproductive harm. The law requires people be informed about exposure to such chemicals. The State of California maintains and updates a list of chemicals known to cause cancer or reproductive toxicity. Consult the State of California to learn more. Businesses are required to give a clear and reasonable warnings before knowingly exposing anyone to a chemical above the listed levels. Warnings are commonly posted in businesses or public areas affected by chemicals. Often, business owners, hotel owners, apartment owners, and managers will post warning signs to notify tenants, guests, and employees of the presence of chemicals on the Proposition 65 list, such as pesticides, lead paint, or asbestos. **PLEASE NOTE:** As manufacturers update their products, new components may be added and these components may fall under the Prop 65 act. As we obtain updated information it will be listed on our website. Please check kleenrite.com for the latest information on products.

NOTE: This information is a summary interpretation and was prepared as general reference material only. This summary is not authoritative as laws can be amended over time. For specific compliance requirements and updates, please refer to the actual code language and the statute or legal counsel at oehha.ca.gov/proposition-65.



VISION:

We will be THE reliable supplier to the car wash industry.

MISSION:

We service our customers with the best people, products and pricing to help them achieve success.

VALUES:

Reliable – *you can count on us.*

Integrity – *always doing the right thing.*

Dedication – *committed to doing our best.*

Family – *we take care of each other.*

Community – *investing in where we live.*

Faith – *God honoring company.*

Profitability – *success breeds success.*



TABLE OF CONTENTS

NEW ITEMS	21	Scent Stone®	103	Hand Tools/Scrapers	177
		Decals & Overlays	104	Brushes & Handles	178
TOWELS BY DOCTOR JOE	22	Vender Deals	114	Detailing Tools	183
Custom Towels Article.....	22	Pet Wash Vending.....	116	Foamers.....	184
Define Your Unique Brand.....	24	Laundry Vending	117	Tank Sprayers.....	186
Bulk Towels.....	26			Polishers & Pads.....	187
Towel Replacement Program	27	RETAIL	119	Extractors.....	196
Giving Towels Longer Life	29	Armor All®.....	119	Steamers	202
Body Drying Towels	30	Blue Magic® Car Care	125	Ozone Machines	203
Glass Towels	33	STP® Car Care.....	126	Pumps & Hydrominders.....	206
Detail Towels	36	Meguiar's® Car Care.....	127		
		Lexol® Car Care	132	PUMPS	207
VENDING.....	40	Mothers® Car Care	133	CAT Pumps®	207
Laurel Venders	41	Stoner	137	General Pumps®.....	216
Vending Kits	44	Simoniz®	139	Pentair Hypro.....	221
Laurel Vender Parts	47	Floor Mats.....	140	Giant.....	222
Kleen-View/Vend Venders	50			Featured: Hydra-Cell.....	225
Rain Tunnel Venders.....	52	DETAIL	142	Arimitsu.....	227
Raddatz Venders.....	57	Ceramic Coating.....	142	Pulsafeeder & Comet.....	229
Vending Products	59	Wheel Care	142	Blue-White®	230
Simoniz® Top Sellers.....	59	Kleen-Shine™	143	Etatron™	231
Armor All® Top Sellers.....	60	Sanitizers/Disinfectants.....	146	Little Giant®	232
Blue Magic Vending.....	62	Simoniz®	147	Procon®	233
Towels	67	Mothers®.....	149	Fluid-O-Tech	234
Character Air Fresheners.....	78	Meguiar's®	151	Flojet®	235
Little Trees®	79	Leather Care.....	156	Sta-Rite	239
Armor All® Air Fresheners	88	Deodorizers	156	Booster Pumps.....	240
Axe Air Fresheners	89	Grit Guard®	157	Goulds.....	241
Handstands® Air Fresheners.....	90	Accessories.....	158	Berkeley	242
California Scents®	92	Gloves	161	Aro Diaphragm	242
Hanging Fresheners.....	94	Safety	162	AR North America	243
Scents™	97	Vehicle Protection	164	Sandpiper®	244
Air Sanitizers	97	Paint Correction	165	Versamatic®	245
Febreze®	98	Steel Wool/Pads	165	Pentair Shurflo	246
Arm & Hammer™	99	Carts & Caddies	166	Yamada®	248
Citrus Magic.....	101	Featured: Towels by Dr. Joe	170	Stenner®	249
Yankee Candle®.....	102	Sponges/Mitts.....	176		

Graco®.....	250	Swivel Cuffs/Nozzles	316	Turbo/High Impact Nozzles	382
Aquatec.....	251	Hoses	320	Trigger Guns/Lances.....	384
PUMP ACCESSORIES	252	Clean Out Bags/Canisters.....	321	Nozzle Protectors	385
Regulators	252	Gaskets/Latches Fuses.....	322	Wands/Lances	386
Relief Valves	252	Fragramatics®.....	323	Foamy Brush Handles.....	389
Unloaders	252	Fragrances.....	326	Brush/Wand Holders	391
Pressure Tanks/Switches.....	264	Shampoos.....	326	Mat clamps.....	393
Strainers, Drains, Dryers	265	Motors & Accessories	327	Brushes.....	394
Flow Switches.....	267	Waste Receptacles	332	Air Switches	403
Motors.....	268	Safety Cones	334	Locks.....	404
Hydraulic Fluid.....	269	Post Guard®	334	Safes	407
Belts, Bushings, Pulleys.....	269	Bollard Covers	335	Rotary Switches.....	408
		Parking Blocks/Bars	337	Meterbox Accessories.....	409
				Featured: KR Coin Boxes.....	410
CHANGERS & COUNTERS	270	LIGHTS.....	338	Coin Boxes.....	412
American Changer	270	Retrofit Kits.....	338	Lubricants & Terminal Kit.....	414
Changers.....	270	Canopy Fixtures.....	339	Booms.....	415
Currency Validators.....	273	Wall Fixtures	339		
Triad	275	Pole Fixtures.....	342	SIGNS, BANNERS, DECALS	419
Standard Change Makers.....	276	Featured: G&G LED	345	Feather Flags.....	419
Hamilton Changers	278	Light Strips	352	Pennants.....	421
Rowe Changers	282	Replacement Bulbs.....	353	Inflatables.....	422
Currency/Coin Counters	284	Pulse Start/Probe Start.....	354	Message Boards/Signs	423
Currency/Coin Sorters.....	284			Sign Holders	424
Coin Baggers/Wrappers	285	ACCEPTORS & TIMERS.....	355	Windmasters	425
Counters/Cleaners.....	286	Validators.....	355	TSS Signs.....	429
Tokens.....	287	Coin Acceptors	357	Outdoor Banners.....	431
Cleaning Cards/Accessories	288	Timers	361	Instructional Signs	432
				Changer Signs	433
VACS & ACCESSORIES	289	BAY ACCESSORIES.....	369	Red & White Signage.....	434
Central Vac Systems	289	Wringers & Sinks.....	369	CryptoPay Signs.....	437
J.E. Adams	289	Gun & Brush Kits	370	Pictorial Signs.....	438
IVS	311	Spray Guns	371	Menu Boards & Strips	440
Decals	313	Foam Guns	374	Rotary Decals	441
Vac Islands	314	Nozzles/Spray Tips	375	Price/Time Decals.....	442
Featured: Express Vacuums.....	315	Spray Arch Assemblies	380	Dog Wash Signs/Decals	445

TABLE OF CONTENTS

SELF-SERVE EQUIPMENT..... 446

Booms/Cleaners	446
Underbody Cleaners	447
Tire Shine Machines	448
Air Shammee.....	459
Dryers.....	451
Hot Wax & Shine Package.....	452
All Paws Pet Wash.....	453
Kleen-Pet™	454
Freeze Prevention	459
Low Pressure Systems.....	461
Prep Units	462

EQUIPMENT..... 463

Security Systems.....	463
Nayax Credit Card System.....	470
Featured: CryptoPay.....	466
IDX Credit Card System	471
Wall Panels/Cleaners	472
Doors.....	473
Wax & Shine System.....	474
Air Compressors	475
Water Softeners	476
RO Systems	478
Membranes/RO Supplies.....	479
Water Heaters	481
Heaters	481
Boilers.....	482
Portable Heaters	483
Pit Cleaners	485
Pit Care	486
Mat Cleaners	488

AUTOMATICS & TUNNELS 491

Roller & Chain Chart.....	491
Roller Replacements.....	496

Chains & Parts	498
Bearings/Flanges/Couplers.....	500
Hydro-Spray	502
Ryko®.....	509
Sonny's®	518
Belanger®.....	527
Motor City Wash Works®.....	532
Hanna™.....	537
MacNeil®.....	543
Southern Pride®	545
Laserwash G5™	546
Popular Parts.....	547
D&S®	548
Proximity Switches	549
Sensors.....	550
Treadles	554

Featured: Char-Lynn® Motors.... 556

Sterling/Parker.....	558
Lubricant/Sealant/Anti-Size.....	559
Tanks.....	560
Foam Generator	561
Valves/Air Cylinders	562
Loop Detectors	563
Undercarriage/Tire Cleaner.....	565
Dryers.....	566
Tire Brushes	567
Cloth & Foam.....	568

PRESSURE WASH 583

Pressure Washers.....	583
Spray Guns	588
Surface Cleaners	590
Water Brooms.....	591
Lances/Wands	592
Brushes/Brooms.....	595
Spray Nozzles/Tips	596

Hose Reels.....	602
Hose	603
Pumps.....	607
Regulators/Unloaders.....	610
Chemical Injectors	613
Chemicals	614

VALVES 616

Manifolds.....	616
Diaphragm Valves	617
Solenoid Valves	618
Safety/Pop Off.....	627
Ball/Metering Valves.....	628
Float Valves	629
Check Valves	634

SWIVELS 637

Swivels	637
Self-Serve Swivels.....	638
Automatic Swivels	638
Gun Swivels	639
Deublin®.....	640
Super Swivels®	641
Mosmatic.....	643

HOSES & FITTINGS..... 646

John Guest®.....	646
SMC® Connectors/Elbows	648
Parker Fittings	650
Banjo Fittings	651
Alpha/Nickel Plated	652
Stainless Steel Fittings	653
Kleen-Rite Brass Fittings	654
Non-Working Swivels	655
Push Lock Fittings.....	656
Barstock Fittings	657

Fast & Tite Fittings.....	659	Pet Wash.....	686	Odor Eliminators	742
Nut/Sleeve Fittings.....	659	Triple Foam.....	687	Powdered Detergents	742
Hydraulic Adapters.....	660	Anti-Freeze.....	688	Bulk Detergents	742
Crimp Fittings.....	661	Kleen-Pak	689	Laundry Retail	743
Tube & Hose Fittings.....	662	Trans-Mate™	704	Laundry Vending	744
Hydraulic Swage Fitting.....	663	National Automotive	707	Money Chutes.....	746
Hose Guards.....	663	JBS®.....	709	Coin/Currency Counters.....	746
Featured: KR Assemblies.....	664	Shore Corporation.....	712	Changers/Bill Breakers	747
Hose/Tubing.....	666	Maintenance	714	Instructional Signs	749
Hydraulic Hose	668	Spill Kits.....	716	Decals/Tags.....	751
Bulk Hose/Tubing	669	Test Kits/Accessories	717		
Hose Assemblies.....	670	Hydrominders.....	719		
High Pressure Hose	671	Aqua Master	723		
Gates Hose.....	672	Injectors.....	724		
Clamp Assemblies.....	673	Proportioners.....	730		

CHEMICALS 675

Featured: KR Concentrates..... 676

Automatic Detergents..... 678

Featured: Kleen-Track..... 680

Simoniz® 683

JANITORIAL & LAUNDRY 735

Carts..... 735

Waste Receptacles

First Aid..... 741

Detergent Dispenser..... 741



PRICES MAY CHANGE WITHOUT NOTICE.

Please check our website for current, up-to-the-minute pricing.

“The reason we’re successful is we keep after things.
We get calls all day long. If it’s something we don’t have, we go search for it.
We tend to business all day and night.”

Harold McKonly
Kleen-Rite Corp. Founder



TERMS & CONDITIONS

TELEPHONE & FAX ORDERS

PLEASE PREPARE YOUR ORDERS IN ADVANCE. WHEN YOU CALL PLEASE PROVIDE THE FOLLOWING INFORMATION:

1. YOUR CUSTOMER NUMBER AND NAME
2. Shipping address if other than billing address
3. Shipping requirements (regular UPS, FED EX Ground, Next Day Air, 2nd Day, 3rd Day, or Freight)
4. Credit card number (Master Card, Visa, Discover, and American Express)
5. PRODUCT NUMBER, description, quantity, etc.

PAYMENT POLICY

We accept payment by Credit Card or ACH Debit.

SHIPPING POLICY

1. All orders are shipped UPS/FedEx Ground or common carrier.
2. Inspect your packages for damage upon delivery & notify delivery agent before they leave your site.
3. Shipping charges are the responsibility of the customer and will be added to all orders.
4. Free Shipping - To qualify your order for free shipping, all orders must be a full pallet of Self-Serve, In-Bay Automatic or Tunnel Soap chemicals.
5. All orders are F.O.B. from Kleen-Rite or from manufacturer. Claims are the responsibility of the carrier.
6. Reshipments due to errors will be shipped UPS/FedEx Ground only.
7. Any quote of freight charges by a salesperson is an estimate only and may vary at delivery time.

SPECIAL ORDERS

** Special orders may be returned only with permission of the manufacturer and may be subject to restocking charges.

PRICES

1. All prices are subject to change without notice.
2. Orders will be invoiced at the prices prevailing at the date of shipment.

BACK ORDERS

1. All backorders are shipped F.O.B. or from manufacturer ASAP
2. Backorders of small dollar value may be held for next order
3. Freight charges will be added to all backorders

HOSE & BOOM ASSEMBLIES

All hose and boom assemblies are made to order .
This may delay your order.

RETURN TERMS & CONDITIONS:

MERCHANDISE POLICY

1. Shortages, lost or damaged goods must be reported within 7 days
2. Call for a return authorization number prior to returning ANY item
3. NO RETURNS WILL BE CREDITED WITHOUT PRIOR AUTHORIZATION FROM KLEEN-RITE.
4. All returns must be accompanied by original invoice
5. No returns will be accepted freight collect

NON-ELECTRONIC ITEMS

1. Non-electronic items must be returned within 45 days*
2. After 45 days your return will be subject to a 15% restocking fee*
NO RETURNS WILL BE ACCEPTED AFTER 90 DAYS

ELECTRONIC ITEMS

1. Electronic items must be returned within 30 days*
2. After 30 days your return will be subject to a 15% restocking fee*
NO ELECTRONIC RETURNS WILL BE ACCEPTED AFTER 60 DAYS

*** ITEMS MUST BE IN ORIGINAL PACKAGING AND IN NEW CONDITION TO BE ELIGIBLE FOR RETURN**

WARRANTY RETURNS

1. All factory warranties are administered by our vendors
2. A vendor evaluation will be required before any warranties can be processed
3. Kleen-Rite will follow the findings of the vendor evaluations and process accordingly
4. Customer service will contact you if additional information is needed

* For additional forms and information, please visit kleen-ritecorp.com. Scroll to the bottom of the website, under "INFORMATION" there you will see "CUSTOMER SERVICE", there you can view detailed information on a variety of topics.

KLEEN-RITE CORP.

YOUR RELIABLE SUPPLIER FOR THE CAR WASH INDUSTRY

KLEEN-RITE CORP. IS A PROUD MEMBER AND/OR SUPPORTER OF THESE FINE CAR WASH ASSOCIATIONS:



NEW ENGLAND CARWASH ASSOCIATION



MID-ATLANTIC CARWASH ASSOCIATION



SOUTHWESTERN CARWASH ASSOCIATION



CAR WASH OPERATORS OF NEW JERSEY



HEARTLAND CARWASH ASSOCIATION



SOUTHEASTERN CARWASH ASSOCIATION



INTERNATIONAL CARWASH ASSOCIATION™
Serving The Professional Car Care Industry

INTERNATIONAL CARWASH ASSOCIATION



NEW YORK STATE CAR WASH ASSOCIATION



WESTERN CARWASH ASSOCIATION



MIDWESTERN CARWASH ASSOCIATION



CONNECTICUT CARWASH ASSOCIATION



CARWASH ASSOCIATION OF PENNSYLVANIA

Save On Shipping Costs AS EASY As.... 1-2-3

1. Buy 150 lbs or more to take advantage on UPS hundred weight and UPS Ground Freight shipping. UPS offers discounts of 15-45% from regular ground rates for multiple packages shipping the same day to the same address, and they deliver on the small package truck. Ground freight shipments must meet the following conditions:

- No hazmat
- Destination in the 48 contiguous states
- Order total must be between 150 lbs and 999 lbs

2. Many cases of vending supplies can be bundled together to help you save on shipping costs. Your salesperson can help guide you to understand what quantities of supplies can help reduce your overall shipping costs. Buy more and save more.

3. Shipping to a business address instead of a residential address saves you money. Both freight carriers and small package service providers charge additional shipment and or per package fees for residential delivery. Ship to a business address and avoid those fees altogether.

FREE But of course, the best way to get way to save on shipping is to pay no shipping costs at all! To qualify your order for free shipping, all orders must be a full pallet of Self-Serve, In-Bay Automatic or Tunnel Soap chemicals. We will ship your pallet anywhere in the continental United States and most provinces in Canada absolutely free. Top off your pallet with vending supplies and parts to experience even more savings.

For your convenience Liftgate service is free to most direct destinations from our select freight carriers. All orders containing 30 gallon and 55 gallon drums will be shipped with a liftgate for your convenience unless you request otherwise. Liftgate delivery may slow arrival of your shipments depending on equipment constraints at the carrier's terminal so please plan your stock accordingly.

HELPFUL CHARTS & TABLES

DILUTION RATIOS

FOR WINTER FOAMING BRUSH DETERGENT AND POLISH

WATER TO PRODUCT	TEMPERATURE	METERING TIP
13-1	30°F to 20°F	Red
8-1	20°F to 10°F	Beige
5-1	10°F to 0°F	Black
3-1	0°F to -10°F	Grey
2-1	-10°F	No Tip

CAR WASH FORMULAS

$$\text{DETERMINING PUMP RPM} = \frac{\text{Rated GPM}}{\text{Rated RPwM}} = \frac{\text{Desired GPM}}{\text{Desired RPM}}$$

$$\text{DETERMINING REQUIRED HP} = \frac{\text{GPM} \times \text{PSI}}{1460} = \frac{\text{Electric Brake}}{\text{HP Required}}$$

$$\text{DETERMINING MOTOR PULLEY SIZE} = \frac{\text{Motor Pulley O.D.}}{\text{Pump RPM}} = \frac{\text{Pump Pulley O.D.}}{\text{Motor RPM}}$$

LAY TUBING ON FITTING CHART FOR SIZING

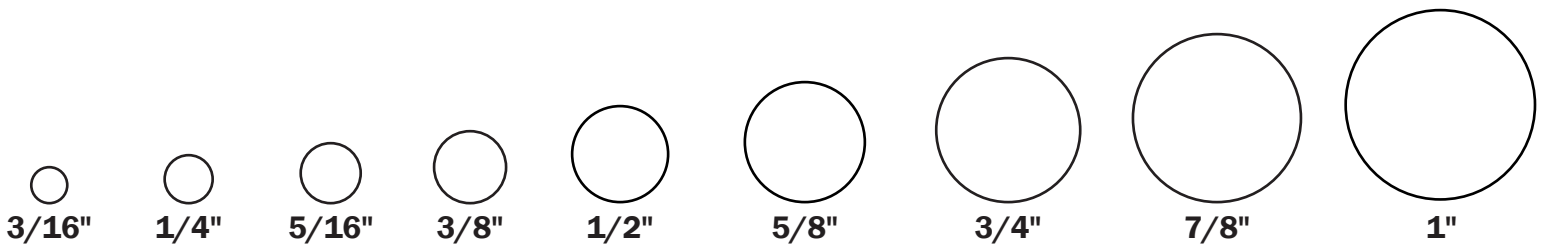

LAY PIPE FITTING ON CHART FOR SIZING

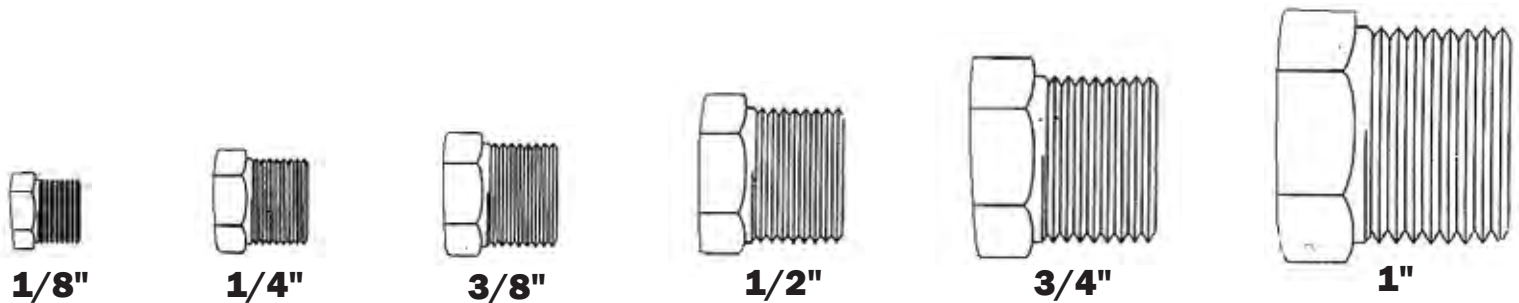

PUMP SLEEVING



GIVE YOUR PUMP NEW LIFE...
 KLEEN-RITE OFFERS STAINLESS STEEL SLEEVING ON
 CAT PUMPS, GENERAL PUMPS & HYPRO PUMPS.
 CALL TODAY FOR MORE INFORMATION!

INVOICES

WE ARE NOW SENDING
 INVOICES BY E-MAIL!
 PLEASE BE SURE TO GIVE YOUR ORDER
 TAKER YOUR E-MAIL ADDRESS.



FAX ORDER FORM

FAX- 800-446-0495 Date _____

Customer Number _____
Business Name _____
Bill To Address _____
City _____ State _____ Zip _____

Ship To # _____
Shipping Address _____
City _____ State _____ Zip _____
Country _____
Phone # _____
Fax # _____
Email _____

Credit Card # on file

Exp. Date _____
CVV2 # _____

Purchase Order Number _____

Name on Card _____

Method of Shipping _____

QUANTITY	PART NUMBER	DESCRIPTION

Authorized Signature _____ Print Name _____

AUTHORIZATION AGREEMENT FOR DIRECT PAYMENTS (ACH DEBITS) For U.S. Bank Accounts ONLY

Company Name: _____ Customer # _____

I (we) hereby authorize KLEEN-RITE CORP. to initiate debit entries to my (our) Checking Account indicated below at the depository financial institution named below, hereinafter called DEPOSITORY, and to debit the same to such account. I (we) acknowledge that the origination of ACH transactions to my (our) account must comply with the provisions of U.S. law.

Depository Name: _____ Branch: _____

City: _____ State: _____ Zip: _____

Routing Number: _____ Account Number: _____

This authorization is to remain in full force and effect until KLEEN-RITE CORP. has received written notification from me (or either of us) of its termination in such manner as to afford KLEEN-RITE and DEPOSITORY a reasonable opportunity to act on it.

Name(s): _____ ID Number: _____

Date: _____ Signature: _____
Please Print

Date: _____ Signature: _____

Note: Debit authorizations must provide that the receiver may revoke the authorization only by notifying the originator in the manner specified in the authorization.

****Please attach voided check****

Effective July 1, 2013 Kleen-Rite Corporation will be implementing a new Payment Policy Change: Any Non-Sufficient Checks or ACH Payments received will incur an additional charge of \$25.00 to off-set the fees we are charged by the bank. We regret that this change must occur, but the fees and tedious work involved in tracking down and clearing these charge backs has made this policy change necessary.

KLEEN-RITE CORP.
YOUR RELIABLE SUPPLIER FOR THE CAR WASH INDUSTRY

Token Approval Form

1. Select Your Token Size

.900
Slightly Smaller than a Quarter

 .984"
Slightly Larger than a Quarter

 1.073"
Slightly Larger than a Dollar Coin

 1.125"
Larger than a Dollar Coin but smaller than a half Dollar

2. Select Your Alloy

Alloy 230
(Available in All Sizes)

Alloy HM1
(.984" Size ONLY)

Alloy HM2
(.984" Size ONLY)

Alloy HM4
(1.073" Size ONLY)

Alloy HM5
(1.073" Size ONLY)

3. Select Your Quantity

• Please note that there is a minimum order of 1000 tokens

• Tokens can be ordered in multiples of 1000 ONLY

_____ Write Quantity Here

4. Select Your Design

Please select a front and back design for your token from the choices below.

_____ Token FRONT Design Number

_____ Token BACK Design Number

Contact Information

Name _____

Customer Number _____

Shipping Address _____

Phone _____

Use credit card on file and process immediately

Please call for confirmation and/or payment info

Signed _____

Date _____

By signing this form you are agreeing to the above order.
Tokens are non-returnable. Please review carefully.



T4



T31



T32



T40



T40B



T41B



T42



T42B



T42C



T43



T43A



T43B



T43C



T43D



T44



T45



T45D



T45V



T95B



EverWash
CAR CLUB

ADD MORE REVENUE THROUGH MONTHLY MEMBERSHIP SALES WITH EVERWASH

EverWash is a marketing company with a unique membership solution for all car washes

Are you interested in membership, but unwilling to spend thousands on an RFID system for your wash? Do you already have a membership program, but struggle to keep up with all of the member accounts, sales and billing? Have you bought in to the idea of membership, but haven't wanted to deal with the headaches you've heard come along with it?



If any of this sounds familiar, there is a solution out there for you: EverWash.

EverWash allows car wash operators to focus on doing what they do best: cleaning cars. This leaves EverWash to focus on attracting new customers, selling memberships, and strengthening customer relationships.

How Does EverWash Work?

Studies show that monthly members are more profitable than the average pay-as-you-go car wash customer, so when it comes to increasing revenues, nothing in the industry comes close to moving the needle like a successful monthly membership program. Rather than having to start each day at zero and chase each dollar, EverWash helps car wash operators create a new revenue stream through monthly recurring revenue, regardless of customer usage year-round, rain or shine.

EverWash is a free-to-use, app-based service that offers users a unique, easy and personalized way to find your car wash, learn about its membership options and easily purchase an unlimited wash plan from the convenience of their smartphone.

While other monthly membership solutions are only able to reach the consumer and sell memberships in the few short minutes that a customer is physically at the car wash, the EverWash app allows customers to quickly and easily become a monthly paying member at any time and from anywhere. These members help generate a predictable and sizeable revenue stream that operators can grow their business around.

However, membership is only part of the EverWash solution.

“ Their app makes it so easy to sell monthly memberships.... Which really improves our bottom line. ”
- KC Fordham, KC's Car Wash

More Than Membership

It takes more than just software to run a successful membership program. Ultimately, EverWash is a marketing company that brings various membership solutions to the table for all types of car washes.

Our sales and marketing team are a resource to our wash partners, providing valuable assistance in outreach marketing, brand consulting, signage, email marketing, social media, web design, and more. The app even features a built-in “Invite a Friend” feature that encourages users to refer contacts to membership at a wash, helping them discover a better, more convenient way to wash their car.

“ We love EverWash and their app. They handle everything; the marketing, member sign-ups, billing, collections... and they pay us! It's that simple. ”
- Dino Nicoletta, Asbury Circle Car Wash

EverWash also issues regular updates to their app and dashboard to ensure that car wash owners and attendants have new tools at their disposal when building membership and engaging with new customers.

Completely Free to Join

EverWash only earns commission based on the additional revenue stream we generate from membership sales. There is no need for pricey RFID equipment, POS systems or intrusive set-ups — EverWash handles all of your membership accounts in-house so you don't have to. This structure keeps EverWash highly motivated and focused on swiftly and seamlessly turning occasional-use customers into more lucrative, loyal members. Ultimately, EverWash shares a common, deeply aligned goal with its partner washes: to grow car wash revenue through increased membership sales and to keep members around for a long time.



Who is Behind EverWash?

EverWash was founded by John Cassady and Scott Caplan — two Philadelphia-based entrepreneurs who revolutionized the health and fitness industry by introducing membership sales and subscription management services to gyms and health clubs nationally. After exiting their respective companies, the duo started EverWash upon realizing that car washes offering monthly memberships could benefit from a more effective and practical way of onboarding and managing new members.



Today, Everwash is made up of a dedicated team of subscription management & membership enrollment pioneers, third generation car wash operators and membership sales & marketing specialists working together with you and your attendants to help grow your revenues.

Why Choose EverWash?

Here are just a few reasons why you should choose EverWash to power your monthly membership program:

- Works with or without a POS system and with most any automated pay station
- No expensive RFID system, monthly maintenance or POS upgrade fees
- 100% free to use, EverWash earns commission based on the additional revenue from membership sales
- World-class member support, signage, email marketing, social media, web design, and more from our sales and marketing team
- True mobile platform allows consumers to sign-up, refer friends and manage their membership 24/7 from their smartphone
- Guaranteed to increase customer base, wash volume and profits

“ Thanks to EverWash, our monthly revenues continue to grow each and every month, even doubled in some months. They’ve really revolutionized how we sell and manage monthlies; a seamless, effortless and substantial increase in business. ”

- Terrence Byrne, Rockaway Car Wash

Why Have Customers When You Can Have Members?

EverWash is committed to bringing innovations and efficiencies to the table, and positioning itself to lead the membership revolution in the car wash industry rather than react to it. Learn more about how EverWash can help double your car washes profits by visiting morewashprofits.com or calling (855) 492-7477.



YOUR ANSWER IS CUSTOM AIR FRESHENERS



Kleen-Rite is now able to offer our customers the ability to purchase customized air fresheners with their own logos and artwork via their Kleen-Rite account!

The custom air fresheners are currently available in seven shapes and 18 different fragrances. Each air freshener comes with full color printing on both sides, strung with white elastic and is packaged in clear wrappers (not carded).

WHY CUSTOM AIR FRESHENERS?

Selling or giving away custom air fresheners is an excellent way to advertise and promote your business at a minimal cost.

“ I like tiny advertisements hanging from vehicles' rear-view mirrors all over town. Considering that I'm a brand new car wash, this is important to me.
- TRENT RICHARDS, Peachy Kleen Car Wash

“ We love the air fresheners that we purchased. Our colored logo looks great on the air freshener and they smell great! Customers like free items and it's a great way to market all of our locations!
- KATY SHAFFER, All Shined Up Car Wash

HOW DO I ORDER? IT'S SIMPLE!

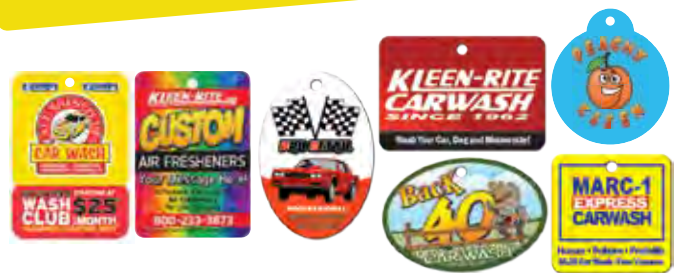

Select a shape
We have 7 options to choose from!

Determine your quantity -
the more you buy, the less each unit will cost.

EXCELLENT FOR
VENDING

LOW COST
GIVEAWAY
FOR PROMOTING
YOUR BUSINESS

Pick your fragrance!

* NOTE: YOU CAN PICK 1 FRAGRANCE PER 1,000 AIR FRESHENERS ORDERED.

Select your artwork!

* NOTE: NOMINAL SET UP AND ARTWORK FEES MAY APPLY BASED ON QUANTITY ORDERED. ALL ARTWORK MUST BE SIGNED OFF ON PRIOR TO PO BEING SUBMITTED FOR PRODUCTION.

AIR FRESHNER SHAPES			
OVAL PORTRAIT		OVAL LANDSCAPE	
RECTANGLE PORTRAIT		RECTANGLE LANDSCAPE	
ROUND		SQUARE	
COUPON			

QTY	\$ EACH	TOTAL	QTY	\$ EACH	TOTAL
50	\$2.36	\$118.00	3,000	\$0.47	\$1,410.00
100	\$1.48	\$148.00	5,000	\$0.42	\$2,100.00
200	\$1.17	\$234.00	10,000	\$0.33	\$3,300.00
500	\$0.84	\$420.00	25,000	\$0.28	\$7,000.00
1,000	\$0.74	\$740.00	50,000	\$0.25	\$12,500.00
1,500	\$0.61	\$915.00	100,000	\$0.23	\$23,000.00

CHERRY	FRESH AIR	CITRUS
DARK ICE	GUAVA	LEMON
STRAWBERRY	CINNAMON	JASMINE
NEW CAR	PEACH	SWEET PEA
VANILLA	BLACK RASPBERRY	CUCUMBER MELON
PINA COLADA	BABY POWDER	PINE

HAVE YOUR OWN LOGO OR ART? GREAT!
Please submit your art as a print ready file - 300 DPI.
(.PSD, .AI, .EPS, .PDF, .JPG are all acceptable formats!)

NEED SOME ART HELP? THAT'S OKAY, TOO!
Someone in the Kleen-Rite graphics department will be able to assist you!

CUSTOM AIR FRESHENERS HAVE A 4-6 WEEK LEAD TIME

New!



New!



New!



SINGLE COLUMN TAP VENDOR WITH CLEAR WINDOW AND LOCKS

LAUREL MECHANICAL VENDORS

- Single column with 19 shelves
- CryptoTap Plus reader for tap and pay with credit cards and digital payment methods
- Maximum product size: 1 3/4" x 4 1/4" x 8"
- Programmable price range: 25¢ to \$99.75
- 24VAC power required, 1/2 amp (500mA) per vendor
- **NOTE:** Vendor **DOES NOT** come with a decal - **DECALS SOLD SEPARATELY**

\$1,645.00	VEL399WDCT-X19	Window Front; Cryptopay Swiper
\$1,645.00	VEL399WCT-X19	Window Front; Cryptopay Tap Plus
\$1,465.00	VEL399WDC-X19	Door Lock, Window Front; Cryptopay Swiper
\$1,645.00	VEL399WDCT-X19	Door Lock, Window Front; Cryptopay Tap Plus



SINGLE COLUMN TAP VENDOR WITH DROP-SHELF

LAUREL MECHANICAL VENDORS

- Single column
- Accepts credit card and digital payment by using a CryptoTap Plus reader. No coin or bills.
- Maximum product size: 1 3/4" x 4 1/4" x 8"
- 24VAC power required, 1/2 amp (500mA) per vendor
- Dimensions: 5 1/4" D x 12 1/4" W x 42" H
- **NOTE:** Vendor **DOES NOT** come with a decal

\$1,400.00	VEL399CT-X	24 Shelves CryptoTap Plus - CC and Digital Payment
\$1,610.00	VEL399CT-X19	19 Shelves CryptoTap Plus - CC and Digital Payment



SINGLE COLUMN TAP VENDOR WITH DROP-SHELF FOR ARMOR ALL TIRE FOAM CANS

LAUREL MECHANICAL VENDORS

- Single Column with 18 shelves designed to easily vend Armor All Tire Foam 4oz cans
- CryptoTap Plus tap and pay reader from CryptoPay for credit card and digital payment
- Programmable price range: 25¢ to \$99.75
- 24VAC power required, 1/2 amp (500mA) per vendor
- Dimensions: 5 1/4" D x 12 1/4" W x 42" H
- Automatic vending - no handles to push or pull
- **NOTE:** VEL699CT-X only has credit card and digital payment capability - no coin or bill acceptance. Also note that it **DOES NOT** have a swiper, so only chip cards will work - no magnetic stripe
- **NOTE:** Vendor **DOES NOT** come with a decal

\$1,470.00	VTF699CT-X	with CryptoTap Plus
\$1,605.00	VTF699CT-MA	with CryptoTap Plus and MA850



CRYPTOTAP PLUS

- Small Footprint
- Stand Alone Unit
- Doesn't need to pair with a swiper
- Outputs pulse the wash timer directly
- Fully EMV
- QR/BCR Reader
- External Red and Green Button
- CryptoTap Plus Works with mobile payments including Samsung Pay, Apple Pay, Google Pay, and others
- No Wireless Fees / No Minimum Quantities

\$500.00	CPS3009	Count Up or Down - Replaces Standard Swiper, Most commonly used on Meter/Coinboxes & Vacuums, External Red and Green Button
\$500.00	CPS3009-MDB	Used on Laurel Dropshelf Vending Machines, No Button Needed
\$510.00	CPS3009-2MDB	Used on Mega-Vender & Raddatz Vendors, Includes MDB Split Cable

NEW ITEMS



3 COLUMN DROP-SHELF VENDING MACHINE WITH CRYPTOTAP PLUS AND SLUGBUSTER

LAUREL MECHANICAL VENDORS

- Uses a CryptoTap Plus reader for credit cards/digital payment and a Slugbuster for coin acceptance
- Requires 24VAC power, has a DigiMax LED display, and its price can be easily programmed from 25¢ to \$99.75
- 72 total shelves (24 x 3 columns)
- **NOTE:** Please take note that this machine **DOES NOT** have a swiper, so only chip cards will work - no magnetic stripe

\$2,201.09	VEL899CT	with CryptoTap Plus
\$2,282.61	VEL899CT-MA	with CryptoTap Plus and MA850
\$2,150.00	VEL899CT-X	with CryptoTap Plus - CC and Digital Payment



5-COLUMN DROP-SHELF LITTLE TREES VENDOR WITH CRYPTOTAP PLUS

LAUREL MECHANICAL VENDORS

- Designed to vend Little Trees air fresheners, with 5 columns that have 36 shelves to hold 180 products total when fully stocked
- Requires 24VAC power, has a DigiMax LED display, and is price adjustable from 25¢ to \$99.75
- **NOTE:** VEL599CT-X only has credit card and digital payment capability - no coin or bill acceptance. Also note that it **DOES NOT** have a swiper, so only chip cards will work - no magnetic stripe

\$3,135.00	VEL599CT-X	CryptoTap Plus
\$3,280.00	VEL599CT-MA	CryptoTap Plus and MA850



4-PIECE CAR CLEANING KITS VENDING

- 100 KITS PER CASE
- For information on each kit and what products are included, check out our vending section on page 45

\$220.00	QBCLEANKIT1	Kit
FREE	QBCLEANKIT1-DECAL	Decal

\$186.67	QBCLEANKIT2	Kit
FREE	QBCLEANKIT2-DECAL	Decal

\$220.00	QBCLEANKIT3	Kit
FREE	QBCLEANKIT3-DECAL	Decal

\$186.67	QBCLEANKIT4	Kit
FREE	QBCLEANKIT4-DECAL	Decal



ZERO SMOKE ODOR ELIMINATOR SPRAY

JENRAY



- 2 oz bottles - 12 bottles to a display box
- Slight citrus scent that lingers briefly, neutralizes the rancid odor, and then fades away
- Sold as single display box with 12, 2oz bottles

\$17.91	DPZS212CD
----------------	------------------

Z-007 I-MINI TORNADOR DETAILING TOOLS



• Introducing the all-new Tornador® Mini. The Z-007 is a compact, yet powerful tool that works with your air compressor to blow debris and moisture out of hard-to-reach areas. The strong, tornado-like funnel of air blasts out dirt and dust quickly and easily. Proven Tornador® technology in the palm of your hand.

- **MAX. PRESSURE:** 90 PSI
- **INLET PORTS:** 1/4"
- **AIR CONSUMPTION:** 226.56 L/m
- **SPEED:** 5000 RPM
- **SOUND DBA:** 94.7-117.4 DBA
- **LIQUID CONSUMPTION:** N/A

\$39.95 DT0135

BOARTEX ULTRA PLASTIC FOAM BRUSH UNIVERSAL BRUSH



- Filled with BOARTEX - soft, synthetic bristles that offer the look, feel, like hogs hair
- 10" wide with 3" exposed bristle length
- Used with standard foam brush handles

\$39.63	F08800-BL	Blue
\$39.63	F08800-BK	Black
\$39.63	F08800-R	Red

BOARTEX ULTRA ALUMINUM FOAM BRUSH WITH BUMPER UNIVERSAL BRUSH



- A flow-through foam brush made of aluminum with a bumper and BOARTEX synthetic bristle fill
- 10" wide with 3" exposed bristle length
- Used with standard foam brush handles

\$40.85	F09800-BL	Blue
\$40.85	F09800-BK	Black
\$40.85	F09800-R	Red



HI-LO SOFT SIDER HOGS HAIR BRUSH ERIE BRUSH



- 10" Block

\$105.65 EB226125



HI-LO SOFT SIDER HOGS HAIR BRUSH ERIE BRUSH



- 4" Bristle
- 5" Block

\$74.70 EB226508



New!

5'1" STAINLESS STEEL Z-BOOM KLEEN-RITE CORP.



• These 360° car wash booms feature a tough design with stainless steel construction. These Z-Booms are ready to use with self-lubricating ball bearings, high quality swivels and a insulated high pressure hose.

- 4000 PSI
- 250 °F maximum temperature
- 3/8" NPTF inlets
- 3/8" NPTF Outlet

\$679.84 B00245



EPHT SERIES GENERAL PUMP

- New forged brass manifold, increases working pressure to 4,000 PSI

\$635.12	GPEPHT1810S GPEPHT1810SL*	GPM: 3.3 PSI: 4000/2465 RPM: 1450
\$560.91	GPEPHT1812S	GPM: 3.9 PSI: 4000/2465 RPM: 1750
\$635.12	GPEPHT1813S GPEPHT1813SL*	GPM: 3.4 PSI: 4000/2465 RPM: 1450

***Left Side Shafts**

EPHT SERIES PUMP OIL GENERAL PUMP

\$6.67	GPO100216	Series 100 Oil - 16oz bottle
\$81.88	GPO100552	Series 100 Oil - 2½ gal.



PHTCK4050S PLUNGER PUMP GENERAL PUMP

- SHAFT OD: 40MM • MAX. TEMP.: 140° F

\$3,704.32	GPPHTCK4050S	GPM: 45
	GPPHTCK4050SL*	PSI: 1500 RPM: 900

***Left Side Shafts**

PHTCK4050S PLUNGER PUMP OILS GENERAL PUMP

\$49.15	GPO100016	Series 220 Oil - 16oz bottle
\$75.19	GPO100450	Series 220 Oil - 2½ gal.



OPERATOR PRO VFD DIRECT DRIVE PUMP STAND KLEEN-RITE CORP.

KLEEN-RITE corp.

- The Operator Pro is a fully-built compact pump stand for six bays. The Operator Pro package reduces the amount of equipment needed to operate the standard car wash functions commonly offered in a car wash bay. Includes trusted CAT Pumps and Baldor motors. Hoses, fittings, regulators, electrical parts, and other components are included and it's basically a plug-and-play unit. Designed to service six bays, and you can choose what functions you need.

PUMP SPECIFICATIONS:

- **MAX FLOW:** 4 GPM
- **MIN. PRESSURE:** 100 PSI
- **MAX PRESSURE:** 2500 PSI
- **INLET SIZE:** 1/2" NPT
- **DISCHARGE SIZE:** 3/8" NPT
- **MAX. SPEED:** 1725 RPM
- **MATERIAL:** Brass

MOTOR SPECIFICATIONS:

- Catalog Number: CEM3615T
- Enclosure: TEFC
- Frame Material: Steel
- Output @ Frequency: 5 HP @ 60 HZ
- Agency Approvals: UR, CSA EEV, CSA
- Ambient Temperature: 104° F
- Base Indicator: Rigid
- Drip Cover: No Drip Cover
- Duty Rating: Continuous
- Efficiency @ 100% Load: 89.5%
- Synchronous Speed @ Frequency: 1800 RPM @ 60 HZ
- Voltage @ Frequency: 460 V @ 60 HZ, 230 V @ 60 HZ
- Current @ Voltage: 13.4A @ 230V, 13.9A @ 208V, 6.7A @ 460V
- Phase: 3
- Frame: 184TC
- Frequency: 60 HZ

CALL FOR PRICING	2 Bay	PS200/PS6A138-2-A
	3 Bay	PS300/PS6A138-3-A
	4 Bay (shown)	PS400/PS6A138-4-A
	5 Bay	PS500/PS6A138-5-A
	6 Bay	PS600/PS6A138-6-A



CLEAN MASTER™ PRESSURE WASH 6000

GATES PRESSURE WASH AND WASHDOWN HOSE



- Formerly PowerClean™ 1 or 2 wire braid

REEL	PART #	WIRE	COLOR	LENGTH	NOM. I.D.	NOM. O.D.	MAX. PSI
\$2.01/ft.	GHCM9385	1	Black	300'	3/8"	.74	6000

REDUCER BUSHINGS

BUSHINGS

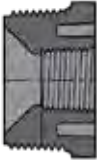

PRICE	PART #	DIMENSIONS
\$2.70	838072	1/2" SLP socket x 1/4" FPT
\$5.94	839131	1" MPT x 3/4" FPT
\$7.44	839128	1" MPT x 1/4" FPT
\$3.80	839101	3/4" MPT x 1/2" FPT

TEE SOCKETS

PIPE FITTINGS



PRICE	PART #	DIMENSIONS
\$4.78	801005	1/2" SLP
\$5.55	805005	1/2" FPT
\$3.67	801101	3/4" SLP

90° ELBOW

FITTINGS



PRICE	PART #	DIMENSIONS
\$6.69	807005	1/2" SLP socket x 1/2" FPT
\$4.89	808007	3/4" FPT x 3/4" FPT
\$4.47	808002	1/4" FPT x 1/4" FPT
\$7.86	807007	3/4" SLP socket x 3/4" FPT
\$8.48	807010	1" SLP socket x 1" FPT
\$1.70	806005	1/2" SLP socket x 1/2" SLP socket
\$2.17	806007	3/4" SLP socket x 3/4" SLP socket

CLOSE PIPE NIPPLE

FITTINGS



PRICE	PART #	DIMENSIONS
\$2.27	883005	3/4" x close MPT
\$4.73	886005	1 1/2" x close MPT
\$2.16	882005	1/2" x close MPT
\$3.00	884005	1" x close MPT

NIPPLE PIPE FITTINGS

FITTINGS



PRICE	PART #	DIMENSIONS
\$4.27	880035	1/4" MPT x 3 1/2" L
\$4.81	880045	1/4" MPT x 4 1/2" L
\$2.38	880015	1/4" MPT x 1 1/2" L

HEX HEAD PLUG

FITTINGS



PRICE	PART #	DIMENSIONS
\$6.59	850015	1 1/2" MPT
\$2.91	850005	1/2" MPT

ADAPTER

FITTINGS



PRICE	PART #	DIMENSIONS
\$3.95	836007	3/4" MPT x 3/4" SLP socket

FEMALE PIPE COUPLER

FITTINGS



PRICE	PART #	DIMENSIONS
\$4.30	835007	3/4" SLP socket x 3/4" FPT
\$6.30	835010	1" SLP socket x 1" FPT
\$2.89	835005	1/2" SLP socket x 1/2" FPT



GRAPE TAFFY LAVA FOAM DETERGENT

JBS



- Premium detergent designed to lift contaminants and rinsing freely
- Designed for tunnel lava arches and self-serve
- High foaming concentrate
- 120/1 average dilution
- Grape Taffy Scent

\$158.44 JB5255



KLEEN-TRACK CERAMIC SEALANT

KLEEN-RITE CORP.



- The perfect complement to the presoaks, as it's ideal for washes where pH is neutralized
- Hydrophobic ceramic polymer formula
- Part of the Kleen-Track 2-Step Process line
- Neutral pH - 7-8 pH
- In a conveyor tunnel wash, apply through the drying agent arch at a rate of 1 to 125-175 parts water
- In a rollover, apply through drying agent or spray wax cycle at a rate of 1 to 125-200 parts water

\$99.00	KRKTC5	5 Gallon
\$559.00	KRKTC30	30 Gallon
\$960.00	KRKTC55	55 Gallon

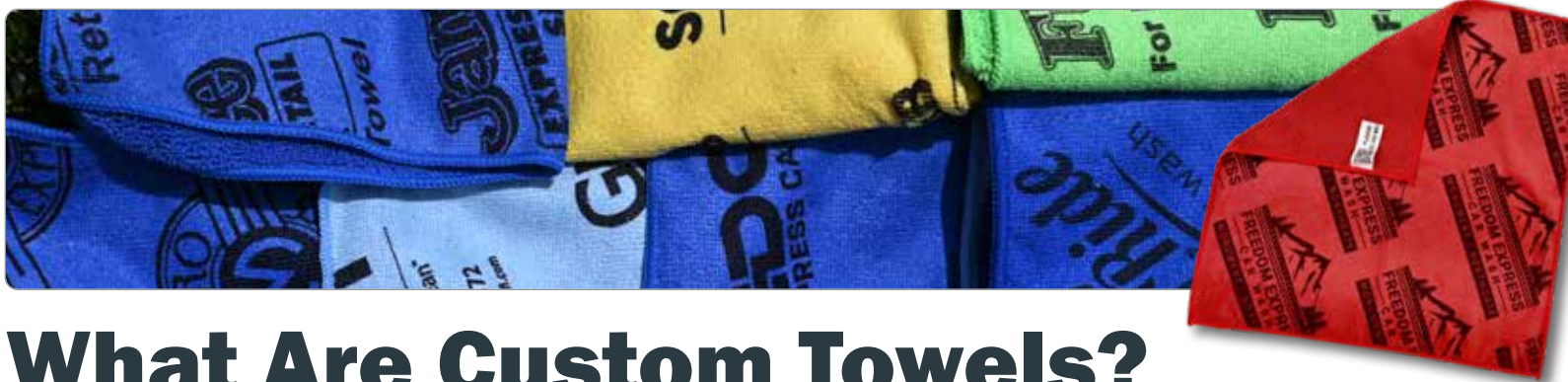

What Are Custom Towels?

“Insanity is doing the same thing over and over and expecting different results.”

The year 2024 is a great time to consider doing something new and energizing for your business. Small positive changes in what we do at our businesses can yield substantial results.

Let's look at an example of modest change that could revolutionize your business. How would you like an additional 1,000+ “Unlimited Monthly Users per location?” It is possible.

Sometimes you must think creatively to transform an occasional customer into a long-time, faithful customer. Most of you buy, sell, and/or use towels. What would happen if you printed a QR code on your towel's label that brought your customer immediately to your website? To make things more exciting, what if they landed on your webpage that made an attractive invitation to join your “Unlimited Club?”

How does it work? Simply scan the towel label on the next page with your phone's camera to see where you go! You can have a printed QR code on all your towels' labels and point your customers in the right direction – to a page that promotes your monthly program.

Towels are something you are probably buying anyway. It is an easy process to take the next step and customize your towels and the towels' labels. You can have your logo, name, and/or your unique message attractively printed on your microfiber towels. The messaging can also make the pitch for your “Unlimited Monthly Plan” as well. Moreover, the towel's label can list an invitation to scan the QR code to find out about “your money saving monthly wash offers.”



If it seems like printed towels could be a good fit for your Car Wash, what do you do next?

I would start by determining what you would like to do with the towel. If towels are provided for a customer's use on premise, you have an immense opportunity to strengthen your car wash's brand by imprinting. For example – close your eyes. Think of a traditional bottle of Coca-Cola®. Do you see it in your head? This is a perfect instance of branding.

Good branding helps your customers identify, relate to, and remember your car wash, in the same way, when they need your services.

What is the first thing your client sees when he arrives at your car wash? It is your big, beautiful sign out front. The last thing your customer should see is your logo, name, and message on a soft printed towel as they perfectly dry their car. The first impression is the same as the last impression. That's called branding. It is a beautiful thing!

More about your printed towels—the best printing process to use on car wash towels is called inkjet sublimation. Your logo, name and message are dyed on a special dual-surface microfiber towel. The printed side of the towel is as soft as the towel itself. Your illustrations and text on the towel do not scratch clearcoat or paint. When you close your eyes and feel the towel...you cannot tell where your images are printed.

There are many choices on how to do this. You can print on (12" x 12"), (14" x 14"), (16" x 16"), (16" x 24"), and (16" x 27") microfiber towels in 300 GSM and 400 GSM. Automated production printing on rolls of microfiber offers the best value and lowest cost. Towels are cut and sewn to the needed size. You can get creative with the towel's label as well. Tyvek® towel labels can be printed in multiple colors, complete with a QR code. The most popular towel color for printing is Royal Blue. It is the darkest color that is printable, which is least likely to show stains. However, towels in all colors are available.

Express Washes use different business models to integrate towel use into their operations. However, one thing is for sure, most customers expect to have towels available for their use in some form. What are some of the interesting ways car washes promote their unique brand with towels in their businesses?

One way is to give printed towels to your customers for FREE in some type of promotion. You can also make a towel offer part of each "Top Wash Package." Special printed towels are also frequently used as giveaways when a new store is opened or during the holidays.

How about selling towels to your customers? Sell them to customers for \$2.00/EA or three for \$5.00. What is wrong with getting your customer to pay you for advertising? Ralph Lauren® and Yves Saint Laurent® have been successfully selling their high-quality products with their names on the merchandise for years.

Another option would be to start a Towel Replacement Program. Sell your beautiful, branded towels for \$2.00 to \$5.00 EA. Each time your customer brings back their soiled towel, you give them a clean one. Don't you think your customer would be curious about the QR code? Nearly everyone has a mobile phone with a camera these days.

What about towel theft? Some operators have an obvious reaction to pilfering. They go cheap. And the customer's experience becomes less important. They start an endless race to the bottom, looking for the smallest, cheapest possible towel in the marketplace. Proof of this is the existence of a friendly towel competitor who refers to his unhemmed towels as "rags."

Just think of what you are doing here. Your customers go through an automated kiosk, into a spotless tunnel, complete with state-of-the-art equipment. Customers are then treated to a light show with endless pampering, colorful foams and wax treatments. It is like going to a spa, but only for their car. At the end of the tunnel your customer drives through a litter-free parking lot with modern vacuums.

The vacuums suck - as they should - but the towels shouldn't. Some folks just dump piles of rags for their customers to use. However, good customer impressions are made until the end. Why would you want to offer dirty, worn, unimpressive towels as the last thing your customer puts their hands on before they leave the lot?

The answer is obvious. Travel in a different direction. Instead of making endless purchases of "rags", consider using towels with your brand recognition. Placing your name and messaging on towels sharply reduces theft. Hotels, hospitals nursing homes, school athletic programs, and gyms have been doing this successfully for about 100 years. Charley Cannon of Cannon Mills® started weaving hotel names into towels in the 1920's. The purpose was for branding and theft reduction. The practice continues to this day and is the most effective way to deter towel larceny.

Here is your bottom line - the QR code promotes your unlimited programs. Your printed logo, company name, and messaging provide brand recognition. The property marks significantly reduce towel theft, especially if used in conjunction with signage. And most importantly, your customer's experience is improved. What's not to like here?

Is there another towel branding option?

Yes. If you would like to stay with black towels, you have the possibility of getting sewn-in custom towel labels for a modest cost, if any. This can only be done offshore, so there is likely to be a minimum order. Nevertheless, you can get far with this, including featuring a QR code and your logo in color.

Are you ready to make a change in 2022? Why invest in everything else, and not your towels? With a powerful program of towel branding with printing and the use of QR codes, you are going to be lifted out of the tunnel into history.

And, if all goes well, you will be able to start taking Sundays off!



Express Towels - Option One

Using Towels to Define Your Unique Brand



What will my custom towel label look like?

The towel's label is important. It is the first element of the towel your customer will notice. This makes it the perfect place to start your pitch! If you place a QR code on the front of the label with a call to action "PLEASE SCAN ME," it is likely that they will. This will bring new and old customers to your website page promoting your Unlimited Car Wash Club, your social media presence, or perhaps an invitation to download your car wash's smartphone app.

It is likely that 80% of all customers will look on the back of the label next. When someone hands you a business card, don't you always turn it over and look on the back? Here is where you make your second pitch.

Are you just getting your foothold? Here is your chance to clarify your message - Join our Unlimited Car Wash Club, Your First Month is FREE. You will never get a second chance to make a second impression!

Are you looking to remind your customers not to take the towels home? How about "THOU SHALL NOT STEAL," or "PLEASE RETURN TOWELS TO USED BIN."

All towel labels are printed on Tyvek®. It is as soft as the towel and will not scratch clearcoat or paint. The label can be made slightly larger to accommodate your message. There is no upcharge for this. The towel's label can be any color. We recommend white or yellow for best contrast. Lastly, your logo can also be reproduced on the label in full color. Our graphic designers will help you make a great impression.

How do I get started with custom-printed towels?

If it seems like printed towels could be a good fit for your car wash, what do you do next?

The first step is easy—give Doctor Joe a call at 1-800-233-3873.

The good doctor will walk you through the towel design steps. When you have a clear vision of what you want to do, the rest is easy. Starting out, we recommend a QR code on the front of the towel's label with and an invitation to "PLEASE SCAN ME." When scanned, your customer will go directly to your website or app, making a pitch for your Unlimited Monthly Wash Club.

If towels are provided for a customer's use on premise, you have an immense opportunity to strengthen your car wash's brand by imprinting your logo, name, and message on the towel. Perhaps a reminder to reduce towel theft: "PROPERTY OF" or "PLEASE RETURN" or even "THOU SHALL NOT STEAL."

If you are giving out towels when opening new stores, the messaging might read "Save money by joining our Unlimited Monthly Wash Club." The QR code on the towel's label will transform your towel into a powerful marketing tool!

Kleen-Rite has a staff of professional graphic designers that will place your ideas on the towels. You will get to see a Photoshop prototype of exactly what your towel will look like. Additionally, we will send you some Doctor Joe printed towel samples. You will be able to feel the texture and quality. The images on the towel are dyed and are as soft as the towel.

The only hard part about the ordering process is containing your enthusiasm waiting for your order to come in!



Options to Feature Your Name, Logo, and QR Code on Towels

Custom Printed Microfiber Towels						Gorgeous Printed Towels and Printed Towel Label including QR Code	
Dual-Surface towels complete with custom towel labels*							
Kleen-Rite Part Number	Color	Towel Size	Towel Weight	MOQ EA 90-120 DAYS	Towels Per Bale	Total Bales	Your Price Each Towel
DJ1212-300-BLB	Royal Blue <small>Towels available in Royal Blue & 9 additional colors</small>	12" x 12"	300 GSM	24,000	1000	24	\$0.38
DJ1414-300-BLB		14" x 14"	300 GSM	19,200	800	24	\$0.49
DJ1616-300-BLB		16" x 16"	300 GSM	14,400	600	24	\$0.58
DJ1624-300-BLB		16" x 24"	300 GSM	9,504	396	24	\$1.00
DJ1627-300-BLB		16" x 27"	300 GSM	8,640	360	24	\$1.20
DJ1616-400-BLB		16" x 16"	400 GSM	12,000	500	24	\$0.85
DJ1624-400-BLB		16" x 24"	400 GSM	7,200	300	24	\$1.35
DJ1627-400-BLB		16" x 27"	400 GSM	12,480	260	48	\$1.45

*FREE SHIPPING in the lower 48

Regular Solid Colored Microfiber Towels						FREE Towel Labels Including QR Code	
Warp Knit towels complete with FREE custom towel labels*							
Kleen-Rite Part Number	Color	Towel Size	Towel Weight	MOQ EA 90-120 DAYS	Towels Per Bale	Total Bales	Your Price Each Towel
DJMF4100-BKB	Black	12" x 12"	300 GSM	24,000	1000	24	\$0.32
DJMF4400-BKB	Black	14" x 14"	300 GSM	19,200	800	24	\$0.40
DJMF4500-BLB	Royal Blue	16" x 16"	300 GSM	14,400	600	24	\$0.52
DJMF4500-YB	Yellow	16" x 16"	300 GSM	14,400	600	24	\$0.52

*FREE SHIPPING in the lower 48

"Best Bang for the Buck" Black Microfiber Towels							
Regular Microfiber towels complete with FREE custom towel labels*							
Kleen-Rite Part Number	Color	Towel Size	Towel Weight	MOQ EA 90-120 DAYS	Towels Per Bale	Total Bales	Your Price Each Towel
DJ1212-215-BKB-X	Black	12" x 12"	215 GSM	33,600	1,400	24	\$0.25
DJ1616-215-BKB-X	Black	16" x 16"	215 GSM	19,200	800	24	\$0.38
DJ1616-280-BKB-X	Black	16" x 16"	280 GSM	14,400	600	24	\$0.45

*FREE SHIPPING in the lower 48

Custom Printed Packages of Microfiber for Vending						3-color printing available		
Complete with custom towel labels- TOWELS ARE NOT PRINTED*								
Kleen-Rite Part Number	Color	Towel Size	Towel Weight	MOQ EA 90-120 DAYS	Towel Style	Towels Per Case	Total Case	Your Price Each Towel
DJ1616BL-XXXXXX	Sky Blue	16" x 16"	280 GSM	15,000	Circular Knit	100	150	\$0.68
DJ1616-260-BLP-XX	Sky Blue	16" x 16"	260 GSM	15,000	Warp Knit	100	150	\$0.54
DJ1216-300-BLP-XX	Sky Blue	12" x 16"	300 GSM	10,000	Warp Knit	100	150	\$0.62

**Towels available in 9 additional colors

Same size as Big Boss

*FREE SHIPPING in the lower 48

Custom Printed Packages of Microfiber for Vending						3-color printing available		
Complete with custom towel labels- TOWELS ARE PRINTED*								
Kleen-Rite Part Number	Color	Towel Size	Towel Weight	MOQ EA 90-120 DAYS	Towel Style	Towels Per Case	Total Cases	Your Price Each Towel
DJ1216-300-BLPPA-XX	Sky Blue	12" x 16"	300 GSM	10,000	Dual Surface	100	100	\$0.72
DJ1515-300-BLPPA-XX	Sky Blue	15" x 15"	300 GSM	15,000	Dual Surface	100	150	\$0.78

**Towels available in 9 additional colors

Same size as Big Boss

*FREE SHIPPING in the lower 48



TOWELS BY DOCTOR JOE®

Express Towels - Option Two

Bulk Towels From 25¢ Each

Doctor Joe has significant inventory of microfiber towels in our Mount Joy, PA; Grand Prairie, TX; Las Vegas, NV; and Kansas City, MO warehouses.
FREE SHIPPING on full pallets in the lower 48.



Pop-Up Microfiber Towels

Dispenser Boxes - portable and affordable!

Kleen-Rite Part Number	Towel Color	Towel Size	Towel Weight	Towels Per Box	Cost Per Box	Free Shipping Full Pallet*	
DJMF1150-BK	Blue	12" x 12"	180 GSM	50	\$14.25	256 Boxes	\$3,648.00
DJMF1150-G	Green	12" x 12"	180 GSM	50	\$14.25	256 Boxes	\$3,648.00
DJMF1150-R	Red	12" x 12"	180 GSM	50	\$11.99	256 Boxes	\$3,069.44
DJMF1150-W	White	12" x 12"	180 GSM	50	\$14.25	256 Boxes	\$3,648.00
DJMF1150-Y	Yellow	12" x 12"	180 GSM	50	\$14.25	256 Boxes	\$3,648.00
DJMF1150-BK	Black	12" x 12"	180 GSM	50	\$14.25	256 Boxes	\$3,648.00

Minimum order is one box

* In the lower 48



DJMF4200-BK

Express Wash Microfiber Towels

Available in nine vibrant colors

Kleen-Rite Express	Towel Color**	Towel Size	Towel Weight	Towels Per Pkg	Cost Per Box	Free Shipping For Full Pallet*	
DJMF4100-BK-50	Black	12" x 12"	300 GSM	50	\$15.50	480 Pkg	\$7,440.00
DJMF4200-BK-50	Black	16" x 16"	280 GSM	50	\$19.00	288 Pkg	\$5,472.00
DJMF4500-BK-50	Black	16" x 16"	300 GSM	50	\$19.50	288 Pkg	\$5,616.00
DJMF4500-BL-50	Sky Blue	16" x 16"	300 GSM	50	\$19.50	288 Pkg	\$5,616.00
DJMF4500-DG-50	Dark Green	16" x 16"	300 GSM	50	\$19.50	288 Pkg	\$5,616.00
DJMF4500-DO-50	Dark Orange	16" x 16"	300 GSM	50	\$19.50	288 Pkg	\$5,616.00
DJMF4500-G-50	Medium Green	16" x 16"	300 GSM	50	\$19.50	288 Pkg	\$5,616.00
DJMF4500-P-50	Dark Purple	16" x 16"	300 GSM	50	\$19.50	288 Pkg	\$5,616.00
DJMF4500-R-50	Red	16" x 16"	300 GSM	50	\$19.50	288 Pkg	\$5,616.00
DJMF4500-RBL-50	Royal Blue	16" x 16"	300 GSM	50	\$19.50	288 Pkg	\$5,616.00
DJMF4500-Y-50	Yellow	16" x 16"	300 GSM	50	\$19.50	288 Pkg	\$5,616.00

Ask about getting Custom Towel Labels on pallet orders for **FREE!

*In the lower 48



DJMF4500-DO-50

"Best Bang for the Buck" Black Express Wash Towels

Sold in full bales only

Kleen-Rite Part Number	Towel Color**	Towel Size	Towel Weight	Towels Per Bale	Your Price Per Bale	Free Shipping Full Pallet*		Total Towels Per Pallet
DJMF8300-BKB	Black	16" x 16"	215 GSM	800	\$272.00	24 Bales	\$6,528.00	19,200
DJMF8400-BKB	Black	12" x 12"	215 GSM	1400	\$312.00	24 Bales	\$7,488.00	33,600

Ask about getting Custom Towel Labels on pallet orders for **FREE!

* In the lower 48



DJMF8300-BKB

Express Towels - Option Three

The Towel Replacement Program

EXCHANGE DIRTY FOR CLEAN

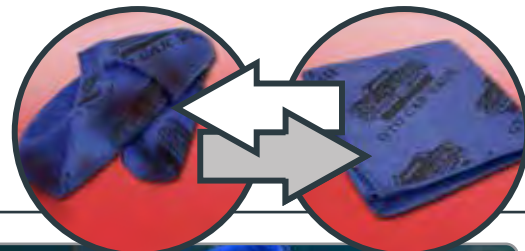

Make a difference in the way your customers remember you by putting your name on towels.

This is where a unique towel is sold “one time” to a customer. Each time the customer returns the same towel, a fresh clean towel is given to replace the soiled towel. The program promotes customer loyalty. The patron can only return the unique towel to where he purchased it – your wash. That is the key. The towel must have characteristics that make it worthy of keeping. It should suggest value, quality, and sustainability. And it must work well.



Custom Printed Microfiber Towels

Dual-surface towels complete with custom towel labels*

Gorgeous Printed Towels and Printed Towel Label including QR Code

Kleen-Rite Part Number	Color	Towel Size	Towel Weight	MOQ EA 90-120 DAYS	Towels Per Bale	Total Bales	Your Price Each Towel
DJ1212-300-BLB	Royal Blue Towels available in Royal Blue & 9 additional colors	12" x 12"	300 GSM	24,000	1000	24	\$0.38
DJ1414-300-BLB		14" x 14"	300 GSM	19,200	800	24	\$0.49
DJ1616-300-BLB		16" x 16"	300 GSM	14,400	600	24	\$0.58
DJ1624-300-BLB		16" x 24"	300 GSM	9,504	396	24	\$1.00
DJ1627-300-BLB		16" x 27"	300 GSM	8,640	360	24	\$1.20
DJ1616-400-BLB		16" x 16"	400 GSM	12,000	500	24	\$0.85
DJ1624-400-BLB		16" x 24"	400 GSM	7,200	300	24	\$1.35
DJ1627-400-BLB		16" x 27"	400 GSM	12,480	260	48	\$1.45

*FREE SHIPPING in the lower 48

Express Towels - Option Four

The Small Order Print Job



If you are looking for a more limited quantity of custom towels we can help you, with smaller runs. Since your order will be prepared offshore, delivery will take 90 to 120 days.

Towel Color	Image & Text Colors	Your Cost Per Towel				
		600 EA	1,200 EA	1,800 EA	2,400 EA*	6,000 EA*
Royal Blue	Black Only	\$1.10	\$1.00	\$1.00	\$1.00	\$0.95
Sky Blue	Multi- Color	\$1.10	\$1.00	\$1.00	\$1.00	\$0.95
Yellow	Multi- Color	\$1.10	\$1.00	\$1.00	\$1.00	\$0.95
Orange	Multi- Color	\$1.10	\$1.00	\$1.00	\$1.00	\$0.95
Custom Pastel Colors	Multi- Color	N/A	N/A	N/A	N/A	\$0.95
Custom Dark Colors	Black Only	N/A	N/A	N/A	N/A	\$0.95

*FREE Towel Labels available on orders of 2,400 or more towels

TOWELS BY DOCTOR JOE®

Non-Printed Towel Replacement Options



DJMF8500-BK



DJMF8500-CHAR

The Platinum Standard - Towel Exchange Microfiber Towels

Best Selection: Heavier Weight, 400 GSM, Distinctive Red Binding

Kleen-Rite Express	Towel Color	Towel Size	Towel Weight	Towels Per Pkg	Quality	Your Price Per Dozen	Free Shipping For Full Pallet*
DJMF8600-BK	Black	16" x 16"	400 GSM	12	Best	\$13.95	480 DZ \$6,696.00
DJMF8600-CHAR	Charcoal	16" x 16"	400 GSM	12	Best	\$13.95	480 DZ \$6,696.00
DJMF8500-BK	Black	16" x 27"	400 GSM	12	Best	\$22.50	300 DZ \$6,750.00
DJMF8500-CHAR	Charcoal	16" x 27"	400 GSM	12	Best	\$22.50	300 DZ \$6,750.00

* In the lower 48



DJMF8000-DG



The Gold Standard - Towel Exchange Microfiber Towels

Better Selection: Larger Size 16x27, 300 GSM

Kleen-Rite Express	Towel Color	Towel Size	Towel Weight	Towels Per Pkg	Quality	Your Price Per Dozen	Free Shipping For Full Pallet*
DJMF8000-BL	Royal Blue	16" x 27"	300 GSM	12	Better	\$18.45	390 DZ \$7,195.50
DJMF8000-BK	Black	16" x 27"	300 GSM	12	Better	\$18.45	390 DZ \$7,195.50
DJMF8000-DG	Dark Green	16" x 27"	300 GSM	12	Better	\$18.45	390 DZ \$7,195.50
DJMF8000-R	Red	16" x 27"	300 GSM	12	Better	\$18.45	390 DZ \$7,195.50

* In the lower 48



DJMF1106-CHAR



The Silver Standard

Sold in packages of 50

Kleen-Rite Part Number	Towel Color**	Towel Size	Towel Weight	Towels Per Pkg	Your Price Per Pkg	Free Shipping Full Pallet*	Total Towels Per Pallet
DJMF1106-CHAR	Charcoal	16" x 24"	300 GSM	50	\$50.00	168 Pkg \$8,400.00	8,400
DJMF1106-RBL	Royal Blue	16" x 24"	300 GSM	50	\$50.00	168 Pkg \$8,400.00	8,400
DJMF1106-DG	Dark Green	16" x 24"	300 GSM	50	\$50.00	168 Pkg \$8,400.00	8,400
DJMF1106-R	Red	16" x 24"	300 GSM	50	\$50.00	168 Pkg \$8,400.00	8,400
DJMF1106-BK	Black	16" x 24"	300 GSM	50	\$50.00	168 Pkg \$8,400.00	8,400

**Ask about getting Custom Towel Labels on pallet orders for FREE!

* In the lower 48



DJMF4500-RBL-50



The Chrome Standard - Towel Exchange Microfiber Towels

Good Selection: Available in nine vibrant colors

Kleen-Rite Express	Towel Color**	Towel Size	Towel Weight	Towels Per Pkg	Cost Per Box	Free Shipping For Full Pallet*
DJMF4500-BK-50	Black	16" x 16"	300 GSM	50	\$19.50	288 Pkg \$5,616.00
DJMF4500-BL-50	Sky Blue	16" x 16"	300 GSM	50	\$19.50	288 Pkg \$5,616.00
DJMF4500-DG-50	Dark Green	16" x 16"	300 GSM	50	\$19.50	288 Pkg \$5,616.00
DJMF4500-DO-50	Dark Orange	16" x 16"	300 GSM	50	\$19.50	288 Pkg \$5,616.00
DJMF4500-G-50	Medium Green	16" x 16"	300 GSM	50	\$19.50	288 Pkg \$5,616.00
DJMF4500-P-50	Dark Purple	16" x 16"	300 GSM	50	\$19.50	288 Pkg \$5,616.00
DJMF4500-R-50	Red	16" x 16"	300 GSM	50	\$19.50	288 Pkg \$5,616.00
DJMF4500-RBL-50	Royal Blue	16" x 16"	300 GSM	50	\$19.50	288 Pkg \$5,616.00
DJMF4500-Y-50	Yellow	16" x 16"	300 GSM	50	\$19.50	288 Pkg \$5,616.00

**Ask about getting Printed Towels & Custom Towel Labels on pallet orders. See page 6 and 7

* In the lower 48

Giving Your Towels a Longer Life Care and Cleaning of Your Investment

Towels are an investment. And like with all things worthwhile, if you take care of your towels, they will take care of you. The purpose here is to provide suggestions to help you get better use out of your towels and give them a longer life.

What about washing microfiber towels?

The most important thing to remember when washing them is to never put a microfiber towel in a dryer on high heat. The fibers will fuse together and render the towel useless. If a dryer is used at all, set it on "air dry" or "low heat".

Contamination found in car wash and detailing towels is far different than the soil, food, and dirt found in other towels around your home. Regular laundry soaps and chemicals are not formulated to professionally clean and revitalize microfiber fabric.

For cleaning and restoring your microfiber towels, we highly recommend Prime Emulsifier, available from Kleen-Rite. It is uniquely formulated to remove the mix of dirt, oil, waxes, and grease from split microfibers. When used regularly, it will clean the fibers, open up the pores, and improve absorbency.

What is important to know about washing cotton towels?

Cotton towels require washing and machine drying before their first use. Nothing will remove more lint from a cotton towel than a few good spin cycles in the dryer. Just remember to clean the lint trap before and after each drying cycle. Washing also makes your cotton towels softer and more absorbent. A good best practice is to use one cup of white vinegar with the first wash load, without detergent. This will help release lint, break the towels in, and keep them fresh. It is also useful to soak new towels in a cup of ammonia and several gallons of warm water. This will dissolve any yarn oils or treatments in the fabric that inhibit absorbency.

If you are using microfiber and cotton towels at the same location, we recommend you use Prime Emulsifier for both items. Although formulated for microfiber, it also works effectively on cotton towels.

There are a few principles that apply to both microfiber and cotton towels:

- Clean towels work better. There is no point in trying to dry a clean car with a dirty towel.
- If a damp towel is dropped on the pavement it needs to be taken out of service and separated from even the dirty towels. The ground-soiled towels could contain sand and stone particles that can scratch paint or worse. These towels need special attention before entering service again.
- All towels need to be washed at least once prior to their first use.
- All towels need to be washed separately. Do not wash cotton with microfiber. Do not mix body towels, window towels, special towels, and detail towels. Each type of towel needs to be washed separately.
- Bleach can damage microfiber and cotton towels. Do not use bleach at all unless you have purchased our special Safe-2-Bleach Towels®.
- Avoid the use of fabric softener on all towels. Sure, it makes the towels softer – but it is water repellent, making them less effective at doing the work you need them to do.
- Damp microfiber and cotton towels are most effective for water removal from vehicles. Water is attracted to water, beading up and merging. Did you ever move two beads of water together on a Formica table? They become one.



PRIME EMULSIFIER MICROFIBER TOWEL CLEANER TOWELS BY DOCTOR JOE

Prime Emulsifier is a gentle cleanser that not only removes oils and dirt from your microfiber towels, but improves their absorbency, too! When used regularly, Dr. Joe's formula opens the pores in towel fibers, allowing more water retention during use, and allowing the release of dirt, oil, and grease during wash cycles. Prime Emulsifier is safe for use on all fibers, including cotton towels, and will not affect the pH of wastewater. Enjoy clean, soft, and absorbent towels! Regular laundry soaps and chemicals are not formulated to professionally clean and revitalize microfiber fabric

- Sold in 5 gallon pails or 55 gallon drums
- Will not affect pH of wastewater
- Safe for all fabrics including microfiber and cotton
- Formulated to remove dirt, oil, wax, and grease from split microfibers

PRIME EMULSIFIER - REGULAR		
DILUTION RATIO: 2 OUNCES/WASH LOAD		
\$99.62	DJMFC02-5	5 Gallon
\$792.41	DJMFC02-55	55 Gallon*

PRIME EMULSIFIER - PREMIUM		
DILUTION RATIO: 1.5 OUNCES/WASH LOAD		
\$1,208.08	DJMFC03-55	55 Gallon*

* 55 GALLON DRUMS ARE DROP SHIP ONLY



TOWELS BY DOCTOR JOE®



BODY DRYING TOWELS - MICROFIBER



SUPER PLUSH MICROFIBER TOWEL

TOWELS BY DOCTOR JOE

Size and weight matter when drying vehicles. With measurements in the hand towel range of 16" x 27", it is the perfect towel for wicking water off cars. Anything larger or denser would be cumbersome and difficult to manage when saturated with water. The ULTRA-85 has been engineered for long use, able to withstand hundreds of washings. Available in solid black or black and charcoal with a distinctive red textured soft nylon edge banding. When properly cared for, this towel is good for 500+ washings!

- Sold 12 per case
- Heavyweight and plush, bleach-resistant
- Each towel measures 16" x 27"
- Attractive red stitched edge

\$22.50	DJMF8500-BK	Black (shown); 400 GSM	Ultra 85
\$22.50	DJMF8500-CHAR	Charcoal (shown); 400 GSM	Ultra 85
\$29.15	DJMF1500-BK	Solid Black	Ultra 15



ULTRA-80 HEAVY WEIGHT BODY DRYING MICROFIBER TOWELS

TOWELS BY DOCTOR JOE

The ULTRA-80 microfiber body towel is the best-selling towel in the car wash industry! Why? The answer is performance and value. ULTRA-80 was designed and manufactured to be a car wash body towel. Doctor Joe created a wish list from car wash operators of what characteristics they were looking for in a body drying towel. The traits included super absorbency, lint-free, dark colors, sustainability, and reasonable price. The recipe was complete. And the result was ULTRA-80, our problem solver towel. It does it all with just one call!

- Sold 12 per case
- Has the soft feel of cotton
- Properly cared for, good for 500+ washings
- Each towel measures 16" x 27"
- Boasts high-quality performance and durability
- For car washes, auto detailing shops, janitorial, & salon

\$18.45	DJMF8000-BL	Royal Blue	\$18.45	DJMF8000-R	Red
\$18.45	DJMF8000-DG	Dark Green	\$18.45	DJMF8000-BK	Black



ULTRA-70 THICK TERRY MICROFIBER TOWELS

TOWELS BY DOCTOR JOE

Ultra-70 is the perfect towel when a heftier towel is needed. Ideal for drying and polishing big stuff like airplanes, RV's, and boats. Its large surface area quickly dries the entire vehicle. Nicknamed "The Big Buff": it will leave your large vehicle with a glossy finish. Anything larger than 20" x 40" would likely be unmanageable when soaked with water. This towel is 325 GSM.

- Sold 10 per case
- Individually wrapped
- Each towel measures 20" x 40"
- Great for car washes, detailers, spas, hotels, & more

\$14.86	DJMF7000-BL	Blue	\$16.99	DJMF7000-DG	Green
\$46.75	DJMF7000-BK	Black	\$15.31	DJMF7000-R	Red



ULTRA-07 VIPER MICROFIBER BODY TOWEL

TOWELS BY DOCTOR JOE

This 300 GSM towel is nicknamed "The Viper" because of its aggressive ability to remove water from a vehicle's surface - absorbs up to eight times its weight in liquid. Soft enough to be used for wax removal and polishing. Dark gray fibers hide stains and won't fade. Ideal as a courtesy towel!

- Sold 50 per case or by pallet
- Each towel measures 16" x 24"
- 300 GSM

KR Part #	Color	Towels Per Pkg	Your Price Per Pkg	Pkg Per Pallet	Pallet Cost*	Total Towels Per Pallet
DJMF1106-CHAR	Charcoal	50	\$50.00	168 Pkg	\$8,400.00	8,400
DJMF1106-RBL	Royal Blue	50	\$50.00	168 Pkg	\$8,400.00	8,400
DJMF1106-DG	Dark Green	50	\$50.00	168 Pkg	\$8,400.00	8,400
DJMF1106-R	Red	50	\$50.00	168 Pkg	\$8,400.00	8,400
DJMF1106-BK	Black	50	\$50.00	168 Pkg	\$8,400.00	8,400

*Free shipping on full pallets in the lower 48



Ask about getting Custom Towel Labels on pallet orders for FREE!

BODY DRYING TOWELS - COTTON



HI-WHITE HAND TOWELS

TOWELS BY DOCTOR JOE

Grab this deal before it's gone! This hand towel is a high quality closeout item. That means it's the same great quality hand towel found in the world's leading hotels. But, we snagged it at a discount just for you. This plush white towel is great for use at car washes, detail shops, hotels and anywhere else you need to quickly dry your hands or other surfaces. Exceptionally durable and absorbent, these towels are made from 100% 12S long-staple cotton. Wash and machine dry prior to use. For use in a wide variety of applications including salons, gyms, spas, car washing, detailing and more.

Styles will vary slightly from order to order.

- Sold 12 per case
- Each towel measures 16" x 27"
- 3.5 lb/dozen

\$11.50 DJT1606-W



ECONOMY WHITE TERRY TOWEL - 15" x 25"

TOWELS BY DOCTOR JOE

The Towels by Doctor Joe white international economy hand towel is a great choice for gyms, salons, hotels, or anyone who just needs a reliable towel to dry off or clean up! It is made of 100% cotton for a classic look and feel. Please note that this pack of 12 towels has been compressed for easier shipping. Simply wash and dry this towel once before use and watch it fluff up to normal size! Ideal for vehicle drying, janitorial use, window cleaning, fitness centers, tanning, gyms and doctors offices.

- Sold 12 per case
- Each towel measures 15" x 25"
- 2.25 lb/dozen
- Economy, 100% cotton towels

\$9.83 DJT1525-W



ECONOMY WHITE TERRY TOWEL - 16" x 27"

TOWELS BY DOCTOR JOE

The Towels by Doctor Joe white international economy hand towel is a great choice for gyms, salons, hotels, or anyone who just needs a reliable towel to dry off or clean up! It is made of 100% cotton for a classic look and feel. Please note that this pack of 12 towels has been compressed for easier shipping. Simply wash and dry this towel once before use and watch it fluff up to normal size! Ideal for vehicle drying, janitorial use, window cleaning, fitness centers, tanning, gyms and doctors offices.

- Sold 12 per case
- Each towel measures 16" x 27"
- 2.75 lb/dozen
- Economy, 100% cotton towels

\$12.44 DJT1625-W

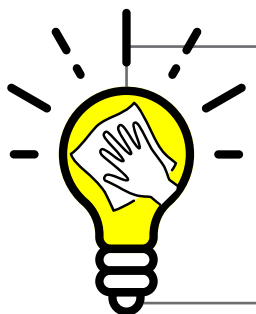

TOWEL TIP

The spotlight is on the Hi-White Hand Towels (DJT1606-W). You cannot buy these towels on your own. These are close-outs from major hotel chains. Nothing will work as well or last as long as a towel made for a hotel!

TOWELS BY DOCTOR JOE®



BODY DRYING TOWELS - COTTON



AMBASSADOR HAND TOWELS

TOWELS BY DOCTOR JOE

It is now possible to bring you hotel quality towels at 20% of the cost. You cannot get this towel anywhere else! Ambassador towels are made from 100% long-staple cotton for greater strength. They are super soft and fully broken-in after just one wash and machine dry. Lint suppression technology makes these 99.6% lint-free. Wide selection of dark colors make these exceptionally stain-resistant.

- Sold 12 per case
- 100% cotton - heavy-weight and absorbent
- Do not use with bleach
- Each towel measures 16" x 28"
- Weighs 4 lb/dozen
- Wash and machine dry prior to first use

\$36.20	DJT1610-BK	Black	\$36.20	DJT1610-EP	Eggplant
\$36.20	DJT1610-DG	Green	\$36.20	DJT1610-NB	Navy Blue
\$36.20	DJT1610-BUR	Burgundy	\$36.20	DJT1610-SG	Sea Green
\$36.20	DJT1610-BO	Bone	\$33.02	DJT1610-W	White
\$26.15	DJT1610-BRN	Brown			



THINK THICK HAND TOWELS

TOWELS BY DOCTOR JOE

Based on the popular, absorbent "hotel towel" concept, this towel design comes from the fact that many car washes like thick, heavy towels for absorbency. This towel is manufactured and designed specifically for car washes. These towels are machine washable. Think Thick hand towels will be perfectly broken-in and super absorbent after only one wash and dry. Not for salon use.

- Sold 12 per case
- 4.5 lb/dozen
- Wash and dry prior to first use
- Each towel measures 16" x 27"
- Excellent for drying cars and wax removal
- Thick, durable made from 100% medical cotton

\$29.43	DJT1604-DG	Dark Green	\$29.43	DJT1604-W	White
\$29.43	DJT1604-NB	Navy Blue	\$29.43	DJT1604-R	Red



THE WATER MOP

TOWELS BY DOCTOR JOE

Based on the popular, absorbent "hotel towel" concept, this is a heavy-weight, 100% cotton, full-terry towel. Plush and absorbent, it's the perfect towel for car wash applications. Finished with real mill end hemming this towel is water absorbent and broken in after just one wash and machine dry. Great for body drying or as a carpet cleaning spotting towel - nothing attracts and holds water like this towel!

- Sold 12 per case
- 6 lb/dozen
- Each towel measures 24" x 24"
- 100% cotton, full-terry towel

\$32.45	DJT2400-W	White
\$35.75	DJT2400-BL	Sky Blue



TRUE COLOR COTTON HAND TOWELS

TOWELS BY DOCTOR JOE

These medium-heavy weight hand towels are made with naturally absorbent cotton and have an incredible soft, plush feel. These True Color cotton towels provide outstanding quality at a fraction of the cost of normal department store retail cost! Dark, rich, vibrant colors make this towel exceptionally stain resistant. Applications include car wash body towel, detailing towel, salon use, spa use. Wash and machine dry these towels prior to their first use, no fabric softener.

- Sold 12 per case
- 3.5 lb/dozen
- Made with 100% long-staple cotton
- Each towel measures 16" x 27"
- Best-selling hand towel - department store quality
- 99.98% lint free - do not use with bleach

\$18.78	DJT1605-NB	Navy Blue	\$18.78	DJT1605-BUR	Burgundy
\$18.78	DJT1605-BK	Black	\$14.25	DJT1605-DG	Dark Green



GLASS TOWELS - MICROFIBER

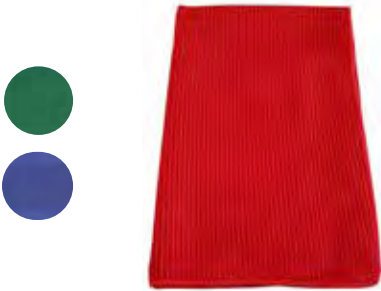

ULTRA-32 WAFFLE WEAVE MICROFIBER TOWELS

TOWELS BY DOCTOR JOE

These 400 GSM towels are classified as waffle-weave glass cleaning towels, because of their superior ability to remove heavy smoke, sticky handprints, and so much more off windshields. The towels also work well as body towels. The small pouches scoop up water and hold it firmly within the towel. If the waffle weave becomes your towel of choice always remember to color code. Use different colors for the windshield and for drying the car's body.

- Sold 12 per case
- Microfiber material
- Great for color-coding use at your business
- Each towel measures 16" x 24"
- Great for glass cleaning, body drying and wax removal
- Absorbs up to 7x its weight in water

\$26.99	DJMF3200-R	Red
\$26.99	DJMF3200-DG	Green
\$26.99	DJMF3200-BL	Blue

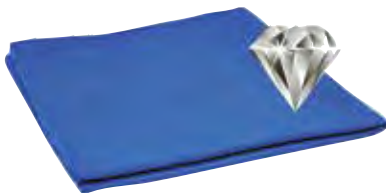

ULTRA-55 DIAMOND MICROFIBER GLASS TOWELS

TOWELS BY DOCTOR JOE

These 300 GSM towels feature a small bird's eye shaped weaving pattern that shaves dirt, grime, streaks, and smoke off glass like a sharp razor. The Black or Blue Diamond can be used as the glass towel of choice in your wash or as the final streak and smear removal cloth. The larger size of Ultra-55 towels means you can cover more surface area in one pass!

- Sold 12 per case
- Microfiber, waffle weave material
- Each towel measures 16" x 24"
- Nano lint-suppression technology

\$16.99	DJMF5500-BL	Blue
----------------	--------------------	------

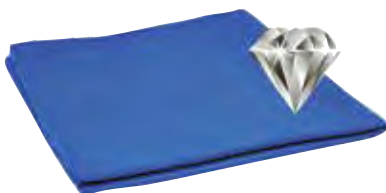

ULTRA-56 DIAMOND MICROFIBER GLASS TOWELS

TOWELS BY DOCTOR JOE

These 300 GSM towels feature a small bird's eye shaped weaving pattern that shaves dirt, grime, streaks, and smoke off glass like a sharp razor. The Black or Blue Diamond can be used as the glass towel of choice in your wash or as the final streak and smear removal cloth.

- Sold 12 per case
- Microfiber, waffle weave material
- Each towel measures 16" x 16"
- Nano lint-suppression technology

\$12.00	DJMF5600-BL	Blue
----------------	--------------------	------

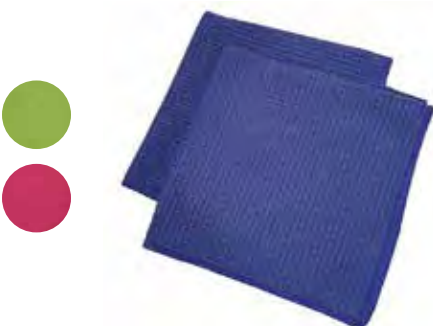

ULTRA-36 WAFFLE WEAVE TOWELS

TOWELS BY DOCTOR JOE

These 400 GSM towels are classified as waffle-weave glass cleaning towels, because of their superior ability to remove grime and more from windshields. The small pouches scoop up water and hold it firmly within the towel. Use different colors for the windshield and for drying the car's body. Great for color coding. Holds up to 7 times its weight in water!

- Sold 12 per case
- Heavyweight microfiber, waffle weave material
- Each towel measures 16" x 16"
- Great for glass cleaning, body drying and wax removal

\$14.50	DJMF3600-G	Grass Green
\$14.50	DJMF3600-BL	Royal Blue
\$14.50	DJMF3600-R	Red Hot Pink

TOWELS BY DOCTOR JOE®



GLASS TOWELS - MICROFIBER



ULTRA-53 DUAL SURFACE GLASS TOWEL

TOWELS BY DOCTOR JOE

One side of each towel is slightly coarser to provide abrasion and lift away dried soap scum, finger prints, smoke, and grime. Safe for use on a variety of glass surfaces, including glass cook tops! The other side is super soft and smooth for completely removing those pesky streaks. Ultra-53 is the perfect glass towel!

- Sold 12 per case
- Streak-free cleaning
- Each towel measures 16" x 16"
- Wicks away moisture and leaves no lint behind

\$14.75	DJMF5300-BL	Blue
----------------	--------------------	------



ULTRA-51 MICROFIBER GLASS CLEANING TOWELS

TOWELS BY DOCTOR JOE

There's nothing quite like looking through a freshly cleaned pair of eyeglasses. Now, your customers can have the same kind of streak-free clarity on their windows, windshields, and mirrors when you use the Towels by Doctor Joe Ultra-51. It is a commercial version of the same cloth provided by your eye doctor, only thicker and heavier.

- Sold 12 per case
- Fine fiber construction with stitched edge
- Great for lint-free cleaning of glass
- Each towel measures 16" x 16"
- 270 GSM
- Great for final wipe in removing streaks and smears

\$12.00	DJMF5100-BL	Blue	\$12.00	DJMF5100-G	Green
\$6.99	DJMF5100-R	Magenta	\$8.99	DJMF5100-Y	Yellow



ULTRA-37 EUROPEAN MICROFIBER WAFFLE TOWELS

TOWELS BY DOCTOR JOE

Pull water, wax, or other liquids off the surface of a car quickly using the Towels by Doctor Joe ULTRA-37 European Microfiber green or blue 335 GSM waffle towels! Water gets whisked away and stored in the dense waffle weave pattern, leaving a clean and streak-free surface behind. Perfect for heavier soils that still require a streak-free finish. Ideal for use on shiny vehicle surfaces, glass, and more!

- Sold 12 per case
- Heavyweight microfiber, waffle weave material
- Each towel measures 16" x 16"
- Textured finish is more abrasive than traditional cloth

\$16.50	DJMF3700-G	Green
\$16.50	DJMF3700-SB	Blue



Dr. Joe products are an economical, high-quality choice for the discerning business owner who wants to provide his customers with fantastic, consistent, results at every visit.



GLASS TOWELS - COTTON

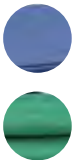

OVERSIZED MEDICAL GRADE SURGICAL TOWELS

TOWELS BY DOCTOR JOE

This surgical towel is made from 100% long-staple cotton. It meets FDA requirements for medical, dental, and veterinary uses. Can also be used as wiping rags, food service rags, bar towels, window cleaners, and wiping products for housekeeping applications. Made with non-toxic colorfast dye and an absorbent-style weave.

- Each towel measures 18" x 30"
- 2.4 lb/dozen
- Extreme lint-free properties

\$14.25	DJS5000-CB-6	Ceil Blue	6 Pack
\$14.25	DJS5000-JG-6	Jade Green	6 Pack



PRE-WASHED SURGICAL TOWELS

TOWELS BY DOCTOR JOE

This smooth non-terry towel is made from 100% cotton. It is lint-free, colorfast, and very absorbent. The long-staple fine-fiber yarn provides the durable characteristics that makes this towel a best seller! Perfect for car washes, housekeeping, lint-free wiping, glass-tinting and glass cleaning. The very same lint-free wiping cloths used during surgery now available for commercial use.

- Sold 12 per case
- 1.6 lb
- Available in 7 colors for color coding
- Each towel measures 16" x 24"
- Autoclavable cotton material
- Laundered to ensure instant absorbency on first use

\$8.99	DJS1600-BL	Blue	\$8.99	DJS1600-P	Pink
\$8.99	DJS1600-G	Green	\$8.99	DJS1600-W	White
\$11.06	DJS1600-O	Orange	\$8.99	DJS1600-Y	Yellow



LAUNDERED SURGICAL HUCK TOWEL

TOWELS BY DOCTOR JOE

These cloths are excellent for cleaning glass, drying, and general cleaning. Though previously used, these cloths have been perfectly washed, sterilized, and recycled. They are laid flat in handy bundles of 10 each, 10 bundles per case (100 total). These surgical huck towels are made of 100% pure cotton and are lint-free.

- Sold 100 per case
- 1.6 lb/dozen
- Each towel measures 16" x 25"
- Washed and sterilized

\$61.97	DJS1150-BL
----------------	-------------------



BLUE FOLDED SURGICAL TOWEL

TOWELS BY DOCTOR JOE

These 100% cotton surgical towels are packed fan-folded and dog-eared. They are lint-free and absorbent. Excellent choice for lint-free wiping, cleaning glass, drying, detailing, and vending at self-serve car washes! Imported from China.

- Sold 100 per carton - 50 pieces per poly bag
- 1.7 lb/dozen
- Each towel measures 16" x 24"
- Fan-folded and dog-eared - ready for lint-free wiping

\$55.00	DJS1700-BL
----------------	-------------------

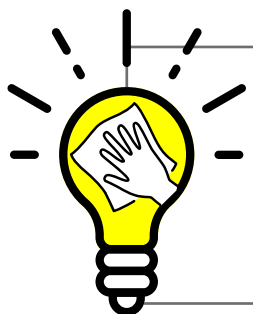

TOWEL TIP

Q: Why do surgical towels make good glass towels?

A: Surgical Huck towels are the same types of cloth used in the medical field for cleaning and wiping. They are required to be lint-free, durable, and absorbent. These are the same necessary characteristics of good glass towels.

TOWELS BY DOCTOR JOE®



DETAIL TOWELS - WIPING AND CLEANING



UTILITY TOWELS WITH COLORED CENTER STRIPE

TOWELS BY DOCTOR JOE



White terry towels with colored center stripe for color coding by use. They are an excellent, economical choice for a courtesy towel at health clubs, tanning salons, gyms, bars, janitorial and more. Wash and dry these towels without fabric softener prior to first use.

- Sold 12 per case
- 32 oz/dozen
- Each towel measures 16" x 19"
- Made from 100% cotton

\$5.99	DJT1680-WGD	Gold Stripe
\$5.99	DJT1680-WGN	Green Stripe



BLUE CLEANING TOWELS

TOWELS BY DOCTOR JOE



Each courtesy towel features a lightweight cotton construction. Use these towels whenever you need a hardworking, 100% cotton product to regularly wipe off hands, pick up quick messes, and more. These towels are a great choice for around-the-shop use at car washes, detail businesses, garages, gyms, tanning salons, food service, bar mop, and janitorial use. Simply wash and dry this towel before use to fluff it up!

- Sold 24 per case
- Approximately 34 oz/dozen
- Each towel measures 16" x 19"
- Lightweight - 100% cottons

\$18.70	DJT1683-BL
----------------	-------------------



ECONOMY CLEANING TOWEL

TOWELS BY DOCTOR JOE



Slightly irregular white terry cleaning towels. Fully hemmed edges prevent unravelling when washing. The most popular choice for general car cleaning – door jams, wheels, trunk well, all areas that collect oily grime and dirt. Towels are compressed to reduce shipping cost. Wash and machine dry to fluff.

- Sold in cases of 25 lb
- Approximately 170 towels per case
- Each towel measures 16" x 19"
- Medium weight- 100% cotton

\$88.00	DJT1685-W
----------------	------------------



ASSORTED COLOR TOWEL REMNANTS

TOWELS BY DOCTOR JOE



When you need a lot of polishing hand towels, but do not need specific colors, this assortment of various towels is a great, economical choice! Applications: heavy wiping and cleaning, detailing, housekeeping, and polishing. Wash and machine dry these towels prior to their first use, no fabric softener.

Because this product is sold by weight, actual number of towels per case will vary.

- Sold by weight - see options below
- Hand towel size, approximately 16" x 26"
- Medium weight, 100% cotton
- Absorbent – good choice for all cleaning purposes

\$63.46	DJT3200-25	25 lb. Pack	Approx. 105 towels per case
\$25.38	DJT3200-10	10 lb. Pack	Approx. 42 towels per case



DETAIL TOWELS - INTERIOR DETAILING



SUPER PLUSH MICROFIBER TOWEL

TOWELS BY DOCTOR JOE

Size and weight matter when cleaning leather, upholstery, and spotting automotive carpeting. Weighing in at 400 GSM this super plush towel is available in 16" x 16" and 16" x 27". The light charcoal color will not bleed or run with automotive cleaners and solvents. These phenomenal microfiber terry towels are the #1 choice for cleaning, scrubbing, dusting, mopping, drying, detailing, and wiping automotive interiors. Properly cared for, this towel is good for 500+ washings!

- Sold 12 per case
- Absorbs up to 7-10 times its weight in moisture
- Heavyweight and plush, bleach-resistant
- Attractive red stitched edge

\$22.50	DJMF8500-CHAR	Charcoal	Ultra 85	16" x 27"
\$13.95	DJMF8600-CHAR	Charcoal	Ultra 86	16" x 16"

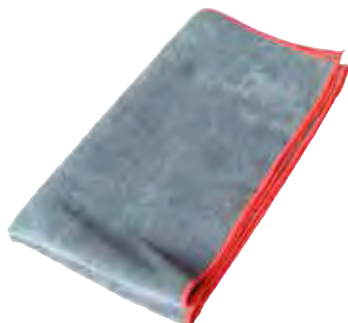

PLUSH INTERIOR DETAILING TOWELS

TOWELS BY DOCTOR JOE

Based on the popular, absorbent "hotel towel" concept, this is a heavy-weight, 100% cotton, full-plush terry towel. This plush and absorbent towel is great for car care applications. This towel is super-absorbent after one wash and machine dry. Use as an applicator or a "spotting" wiper for upholstery and carpeting. Excellent for cleaning and moisturizing leather seats and steering wheels. This handy, all-purpose towel can be used in janitorial, food service and housekeeping applications.

- Sold 12 per case
- Each towel measures 14" x 16"
- Approximately 2.25 lb/dozen
- Heavy weight material; hotel quality
- 100% cotton, full-terry towel
- Finished with real mill end hemming

\$14.85 DJT1460-W



ALL PURPOSE MICROFIBER TOWELS

TOWELS BY DOCTOR JOE

The 300 GSM All Purpose Microfiber Towel provides the performance and durability of microfiber with the supple feel of standard cotton towels. Available in three pastel colors, this cloth furnishes the detailer with opportunity to "color code," identifying a color with a job. Safe to use on electronic equipment and other sensitive surfaces with interior detailing. Use damp for general cleaning; wet for scrubbing heavily soiled areas; and dry for dusting. Excellent for use in leather cleaning and conditioning.

- Sold 12 per case
- Each towel measures 16" x 19"
- Pastel colors do not bleed
- Safe for use on vinyl, plastics, wood, and metal

KR Part #	Color	Towels Per Pkg	Bracket Pricing		Pallet Price*	
			1-11 Pkg	12 (+) Pkg		
DJMF4500-BL-50	Sky Blue	50	\$19.50	\$26.00	288 Pkg	\$7,488.00
DJMF4500-G-50	Medium Green	50	\$19.50	\$26.00	288 Pkg	\$7,488.00
DJMF4500-Y-50	Yellow	50	\$19.50	\$26.00	288 Pkg	\$7,488.00

*Free shipping on full pallets in the lower 48



WHITE UTILITY TOWEL

TOWELS BY DOCTOR JOE

Each white utility towel features a lightweight cotton construction. Use these towels whenever you need a hardworking, 100% cotton product to regularly wipe off hands, pick up quick messes, and more. These towels are a great choice for around-the-shop use at car washes, detail businesses, garages, and more. Also for use as a courtesy towel, gym towel, tanning towel, food service, bar mop and janitorial tool.

- Sold 12 per case
- Each towel measures 16" x 19"
- 100% cotton
- Lightweight for utility applications
- 28 oz/dozen
- Wash and dry prior to use - do not use fabric softener

\$7.25 DJT1681-WHT



TOWELS BY DOCTOR JOE®



DETAIL TOWELS - POLISHING



THE BLACK BEAUTY – OPTION 1

TOWELS BY DOCTOR JOE

Also known as Ultra-05, this option is a plush handy microfiber polishing cloth. It is available in any color you want so long as it is black! Its small size, 12" x 12", is ideal for reaching tiny crevices and small panels and for touch-up. Perfect for removal of ceramic coatings. Extremely durable - able to withstand hundreds of washings with proper care and washing.

- Sold 12 per case
- 300 GSM
- Each towel measures 12" x 12"
- 80/20 blend

\$10.07 DJMF0500-BK Black



THE BLACK BEAUTY – OPTION 2

TOWELS BY DOCTOR JOE

Also known as Ultra-82, our second option is a plush handy microfiber polishing cloth. It is also available in any color you want so long as it is black! The Ultra-82 is a heavy-duty towel offering incredible performance and durability of microfiber, but the supple feel and heavy weight of a standard cotton towel. The Ultra-82 is a 16" x 16" towel made with 300 GSM microfiber fabric that offers max absorbency and extraordinary polishing capabilities.

- Sold 12 per case
- 300 GSM
- Each towel measures 16" x 16"
- 80/20 blend

\$13.75 DJMF8200-BK Black



ALL-PURPOSE BUFFING TOWELS

TOWELS BY DOCTOR JOE

These Ultra-45 towels by Doctor Joe are 300 GSM microfiber towels that measure 16" square. Sold in new easy-to-manage yet economical bulk packs of 50 towels. Perfect for removal of polish, wax, compound, glaze, sealant, and detailing sprays. Use for buffing, spray waxes, and the final buff. Now offered in nine vibrant colors, helping you to color code towels for specific detailing processes.

- Sold 50 per case or by pallet
- Warp knit, overlocked finished edges
- Each towel measures 16" x 16"
- 80/20 microfiber blend



DJMF4500-RBL-50

KR Part #	Towel Color	Towels Per Pkg	Cost Per Box	Pallet Price
DJMF4500-BK-50	Black	50	\$19.50	288 Pkg \$5,616.00
DJMF4500-BL-50	Sky Blue	50	\$19.50	288 Pkg \$5,616.00
DJMF4500-DG-50	Dark Green	50	\$19.50	288 Pkg \$5,616.00
DJMF4500-DO-50	Dark Orange	50	\$19.50	288 Pkg \$5,616.00
DJMF4500-G-50	Medium Green	50	\$19.50	288 Pkg \$5,616.00
DJMF4500-P-50	Dark Purple	50	\$19.50	288 Pkg \$5,616.00
DJMF4500-R-50	Red	50	\$19.50	288 Pkg \$5,616.00
DJMF4500-RBL-50	Royal Blue	50	\$19.50	288 Pkg \$5,616.00
DJMF4500-Y-50	Yellow	50	\$19.50	288 Pkg \$5,616.00

Free shipping on full pallets in the lower 48



LARGER ALL-PURPOSE BUFF TOWELS

TOWELS BY DOCTOR JOE

Many professional detailers prefer to work with a larger buff towel for wax removal. This towel is the big brother of the ALL-PURPOSE BUFF TOWELS, measuring 16" x 24" in size. With added surface area, the larger towel reduces buffing time. It is also less likely to get filled with wax cake. Perfect for removal of polish, wax, compound, glaze, sealant, and detailing sprays. Use for buffing, spray waxes, and the final buff. Now offered in five vibrant colors.

- Sold 50 per case or by pallet
- Each towel measures 16" x 24"



DJMF1106-CHAR

KR Part #	Color	Towels Size	GSM	Towels Per Pkg	Your Price Per Pkg	Free Shipping Full Pallet*	Towels Per Pallet
DJMF1106-CHAR	Charcoal	16" x 24"	300	50	\$50.00	168 Pkg \$8,400.00	8,400
DJMF1106-RBL	Royal Blue	16" x 24"	300	50	\$50.00	168 Pkg \$8,400.00	8,400
DJMF1106-DG	Dark Green	16" x 24"	300	50	\$50.00	168 Pkg \$8,400.00	8,400
DJMF1106-R	Red	16" x 24"	300	50	\$50.00	168 Pkg \$8,400.00	8,400
DJMF1106-BK	Black	16" x 24"	300	50	\$50.00	168 Pkg \$8,400.00	8,400

**Ask about getting Custom Towel Labels on pallet orders for FREE!

*In the lower 48

DETAIL TOWELS - PLUSH POLISHING



SUPER PLUSH MICROFIBER TOWEL

TOWELS BY DOCTOR JOE

These lavish towels are perfect for removing cured paste waxes and sealants. Excellent for wiping away dust, dirt, and debris or for use with spray waxes, resulting in a streak-free shine. Size and weight matter when buffing vehicles. This unique towel is offered in two useful sizes - 16" x 16" and 16" x 27". It is the perfect towel for use with detail sprays or even the final buff. These towels have been engineered for long use, and will withstand hundreds of washings. Available in solid black or black and charcoal with a distinctive red texturized soft nylon edge banding. When properly cared for, this towel is good for 500+ washings!

- Sold 12 per case
- Heavyweight and plush, use for ceramic coatings
- Good for compound removal
- Removes, sealants, polishes, glazes, and waxes

\$22.50	DJMF8500-CHAR	Charcoal (shown); 400 GSM	Ultra 85	16" x 27"
\$22.50	DJMF8500-BK	Black (shown); 400 GSM	Ultra 85	16" x 27"
\$29.15	DJMF1500-BK	Solid Black	Ultra 15	16" x 27"
\$13.95	DJMF8600-CHAR	Charcoal; 400 GSM	Ultra 86	16" x 16"
\$13.95	DJMF8600-BK	Black; 400 GSM	Ultra 86	16" x 16"



DJMF2536

TOWELZILLA™ - THE EXTREME DETAILING TOWEL

TOWELS BY DOCTOR JOE

Doctor Joe is delighted to introduce TowelZilla™, the ultimate car cloth. The towel is made from a super-thick, plush microfiber coral fleece that introduces a softness that is unrivaled in the Automotive Appearance Industry! It simply trounces the competition. Dare I say there is no competition. Everything is big about TowelZilla, except its price. Weighing in at a monstrous 780 GSM, it is available 18" x 30" or 25" x 36", both in charcoal gray. TowelZilla is equally suitable for drying vehicles, wax removal, and unsurpassed for use in the final buff. Size matters and TowelZilla is the T-Rex of towels!

- Will not scratch paint, clear coat, or other surfaces
- Maximum plushness when a higher pile is preferred
- Deep velvet pile makes it ideal for the final polish
- Guaranteed streak-free, lint-free, and non-abrasive

KR Part #	Color	Towels Size	Towels Weight	Towels Per Pkg	Pkgs Per Case	Your Price Per Pkg
DJMF1830-GRY	Charcoal	18" x 30"	780 GSM	3	12	\$23.50
DJMF2536-GRY	Charcoal	25" x 36"	780 GSM	1	20	\$12.95



DJMF1830

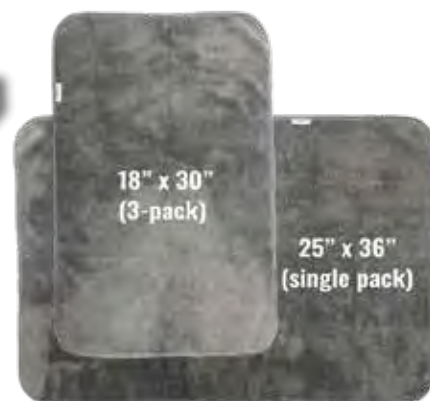



Little Trees®

Essential *For your wash*



The amount of FREE Little Trees included varies based on the model of the machine you order.



LAUREL
METAL PRODUCTS INCORPORATED

These vendors include a generous amount of **FREE** Little Trees, the scent of your choice, so you can start generating revenue right away!

LAUREL VENDING MACHINES



**DID YOU KNOW...
WE NOW OFFER FINANCING!**
Available through QuickSpark Financial



THREE COLUMN ELECTRONIC VENDOR WITH DIGI-MAX DISPLAY

- **VEND CAPACITY:** 72 products
- **DIGI-MAX DISPLAY** shows price setting, amount inserted, vend sales count, etc.
- **24 VOLT AC POWER REQUIREMENT**
- **MOTORIZED SHELF DROP:** No handles to pull
- **PRICE ADJUSTMENT:** \$0.25 - \$99.75
- **MAX PRODUCT SIZE:** 1¼" x 4¼" x 8"
- **SHIP WEIGHT:** 145 lbs.
- **COIN BOX:** Equipped With lock & 2 keys
- **MACHINE SIZE:** 42" H x 19¼" W x 12"

\$1,624.13	VEL899MAX	Slugbuster
\$1,705.27	VEL899MAX-MA	MA850
\$1,786.25	VEL899MAX-QL	MicroCoin QL
\$1,570.03	VEL899MAX-X	No Coin Mech

THREE COLUMN WITH CRYPTOPAY WITH CREDIT CARD SWIPER

\$2,017.27	VEL899MAXC	Slugbuster
\$2,097.05	VEL899MAX-MAC	MA850
\$2,178.02	VEL899MAX-QLC	MicroCoin QL
\$1,963.21	VEL899MAXC-X	No Coin Mech

DIGI-MAX DISPLAY RETROFIT KITS CONVERSION KIT FOR 1, 3 & 5 COLUMN ELECTRONIC VENDORS

- Complete new door assembly and security frame
- Digi-Max circuit board
- Plastic circuit board cover
- Door programming decal
- Large dot matrix display
- CryptoPay credit card payment options
- Vend price setting up to \$99.75 per product

SINGLE COLUMN RETROFIT KITS LAUREL ELECTRONIC VENDORS

\$361.73	LP39960	Drop-Shelf
\$767.70	LP39959	Drop Shelf with CryptoPay
\$365.17	LP259941	Tire Foam Vendor
\$775.28	LP259959	T.Foam Vend. w/CryptoPay

3 COLUMN RETROFIT KITS LAUREL ELECTRONIC VENDORS

\$460.67	LP89972	Standard Kit
\$861.27	LP89973	With CryptoPay

5 COLUMN LITTLE TREES RETROFIT KITS LAUREL ELECTRONIC VENDORS

\$460.67	LP59967	Standard Kit
\$872.58	LP59968	With CryptoPay



5 COLUMN ELECTRONIC VENDOR LITTLE TREES VENDOR WITH DIGI-MAX DISPLAY

- **VEND CAPACITY:** 180 Little Trees
- **DIGI-MAX DISPLAY:** Shows price setting, amount inserted, vend sales count, etc.
- **24 VOLT AC POWER REQUIREMENT**
- **MOTORIZED SHELF DROP:** No handles to pull
- **PRICE ADJUSTMENT:** \$0.25 - \$99.75
- **SHIP WEIGHT:** 170 lbs.
- **COIN BOX:** Equipped With lock & 2 keys
- **MACHINE SIZE:** 41" H x 21" W x 11½" D
- **INCLUDES: 864 LITTLE TREES AIR FRESHENERS - SCENT OF YOUR CHOICE!**

\$2,710.87	VEL599MAX-MA	MA850
\$3,226.09	VEL599MAX-MAC	MA850 & CryptoPay Swiper
\$3,144.57	VEL599MAXC-X	No Coin Mech Has CryptoPay Swiper



You can add **CryptoPay** to any vending machine on this page!



VENDING



LAUREL VENDING MACHINES



288 FREE TREES WITH PURCHASE

SINGLE COLUMN ELECTRONIC VENDOR

WITH DIGI-MAX DISPLAY

- LARGER DOT MATRIX DISPLAY
- CRYPTOPAY CREDIT CARD OPTION
- LANGUAGE CHOICES, BRIGHTNESS SETTINGS
- VENDOR PRICE: up to \$99.75
- VENDOR CAPACITY: 24 Products
- 24 VOLT AC POWER REQUIREMENT
- SIMPLE CUSTOMER INTERFACE
- MOTORIZED SHELF DROP: No handles to pull
- MAX PRODUCT SIZE: 1 1/4" H x 4 1/4" W x 8" D
- SHIP WEIGHT: 49 lbs.
- MACHINE SIZE: 42" H X 12 1/4" W X 5 1/4" D

SINGLE COLUMN

\$897.85	VEL399MAX	Slugbuster
\$978.50	VEL399MAX-MA	MA850
\$1,059.14	VEL399MAX-QL	Microcoin QL
\$844.09	VEL399MAX-X	No Coin Mech

SINGLE COLUMN WITH CRYPTOPAY

\$1,236.56	VEL399MAXC-X	No Coin Mech
\$1,290.32	VEL399MAXC	Slugbuster
\$1,370.97	VEL399MAXC-MAC	MA850



YOU CAN ADD CRYPTOPAY TO THESE MODELS!

ARMOR ALL TIRE FOAM VENDOR

WITH DIGI-MAX DISPLAY

- VENDS 4 oz. Tire Foam cans
- DIGI-MAX DISPLAY
- CRYPTOPAY CREDIT CARD OPTION
- VENDOR CAPACITY - 18 cans
- VENDOR PRICE: up to \$99.75
- 24 VOLT AC POWER REQUIREMENT
- MOTORIZED CAN DELIVERY: No handles to pull
- SHIP WEIGHT: 46 lbs.
- MACHINE SIZE: 42" H x 12 1/4" W x 5 1/4" D

SINGLE COLUMN ARMOR ALL 4 OZ. TIRE FOAM VENDOR

\$962.24	VTF699MAX	Slugbuster
\$1,044.41	VTF699MAX-MA	MA850
\$1,125.46	VTF699MAX-QL	Microcoin QL

SINGLE COLUMN WITH CRYPTOPAY ARMOR ALL 4 OZ. TIRE FOAM VENDOR

\$1,359.28	VTF699MAXC	Slugbuster
\$1,441.39	VTF699MAXC-MAC	MA850

1 COLUMN, LITTLE TREES DEAL

LAUREL MECHANICAL VENDORS

- VENDOR CAPACITY: 24 Little Trees®
- Stainless steel construction with stainless steel security bar
- PRICE ADJUSTMENT: \$0.50 - \$3.00
- 1 single column Car-Freshner decal available for free. Must add to cart separate.
- INCLUDES: 288 LITTLE TREES AIR FRESHENERS - SCENT OF YOUR CHOICE!

\$689.13 **VEL800CF**



Did you know you get a free decal for the scent you order? Make sure to add **VE0139** to your order and specify the scent!

LAUREL VENDING MACHINES - MECHANICAL



PRODUCTS MUST VEND AT SAME PRICE



SINGLE COLUMN MECHANICAL VENDOR

LAUREL MECHANICAL VENDORS

- Vends various flat products
- Adjustable vend prices
- Stainless steel construction
- Holds up to 24 individual products
- Will fit product up to 1 1/4" x 4 1/4" x 8"
- Please note that this vendor DOES NOT come with a decal - **DECALS SOLD SEPARATELY**



COIN MECHANISM PRICE ADJUSTABLE FROM \$0.50 TO \$3.00

SINGLE COLUMN VENDOR

\$599.99 VEL800

COIN MECHANISM PRICE ADJUSTABLE FROM \$.25 TO \$1.00

SINGLE COLUMN VENDOR

\$499.98 VE0201

5 COLUMN LITTLE TREES® MECHANICAL VENDOR

LAUREL MECHANICAL VENDORS

- **VEND CAPACITY:** 180 Little Trees®
- 36 shelves per column
- **PRICE ADJUSTMENT:** \$0.25 - \$1.50
- **SHIP WEIGHT:** 165 lbs.
- **MACHINE SIZE:** 41"H x 21"W x 11 1/2"D
- 5 column Car-Freshner® decal
- **INCLUDES: 864 Little Trees® Air Fresheners - Scent of your choice!**

\$1,910.87 VE0206

SINGLE COLUMN MECHANICAL BOTTLE VENDOR

LAUREL MECHANICAL VENDORS

- 42" H x 12 1/4" W x 6 1/2" D
- Vends 4 oz. round pump bottles
- Capable of vending towels & packets
- Prices adjustable from \$0.50 - \$3.00
- Cabinet 12 1/4" x 42" x 5 1/4"
- Stainless steel
- Includes security bar
- **OPTIONAL VAULT READY AT ADDITIONAL COST**

\$566.21 VEL900

3 COLUMN DROP SHELF VENDOR

LAUREL MECHANICAL VENDORS

- \$0.25 - \$1.50 vend pricing
- 72 shelf capacity - 24 per column
- **MAXIMUM PRODUCT SIZE -** 1 1/4"H x 8"W x 4"D
- **CABINET SIZE -** 42"H x 19 1/4"W x 12"D, add 1 1/4" to front for security frame
- 145 lbs.

\$1,177.42 VEL300

THE INCLUDED FREE LITTLE TREES® WILL BRING BACK **\$1,080.00** IF SOLD FOR **\$1.25** EACH.

THIS MACHINE VENDS "OLD STYLE" ROUND BOTTLES

The 3 Column Drop shelf vendor is available with a **KLEEN-RITE, Armor All®** or **Simoniz®** Car care center decal (VE0160, VEL300, SMD900)

KLEEN-RITE CORP.



YOU HAVE HAD 61 YEARS TO GET TO KNOW WHY LAUREL MEANS "DEPENDABILITY IN VENDING" and is the first choice when purchasing car wash vending equipment for your wash.

Laurel began operation in a similar way to that of many companies in the car wash field. In 1959, Rich Kent incorporated a company that had its beginning in the basement of a house on Laurel Avenue in Wilmette, IL. The early work at Laurel involved the production of many different types of metal products and the continuing development of equipment to vend a wide array of consumer products.

VENDING KITS

ALL NEW VENDING KITS FROM KLEEN-RITE!

• 100 kits per case • Customized kits available - call for a quote



CALL FOR PRICING



ELECTRONIC KIT VENDING MACHINE

BY LAUREL METAL PRODUCTS

- Vending packs fit perfectly in this machine
- This vendor operates on 24 volt AC power and is price adjustable from \$0.25 to \$99.75
- Automatic shelf drop
- Stainless steel cabinet & door
- LED display shows vend price, amount paid, vend sales count, sold out when empty
- **CANNOT VEND SPRAY CANS**

\$1,429.37	VEL399MAXDC-X	24 Slot • 1¼"
\$1,425.00	VEL399MAX-KV	19 Slot • 1¼" Larger Slot Capacity for kits



CREDIT CARD ONLY

Must use a CryptoPay Coordinator CPS3000 with this machine!



1 COLUMN DROP-SHELF VENDOR

LAUREL METAL PRODUCTS

- The Laurel Metal 399-MAX-CC-X-19 vending machine is a single column electronic unit featuring 19 1-3/4" slots, perfect for all kinds of products!

FEATURES (19) 1¼" SLOTS

- 24V electrical connection
- Adjust pricing from \$0.25 to \$99.75
- Heavy-duty stainless steel security frame
- Use your own padlock of choice
- Use with any single column vendable product and decal
- No coin acceptor
- Comes with DigiMax display and card swiper

\$1,425.00	VEL399MAXC-X19
-------------------	-----------------------



1 COLUMN VENDOR POLE MOUNTING KIT

LAUREL METAL PRODUCTS

- The Laurel 399-200-3 Mounting Kit is used to install a single column vendor on the side of a 3" square or round pole.
- **KIT INCLUDES:**
 - (2) 399-200 Mounting brackets
 - (2) 399-201 U-bolt filler bracket
 - (2) Square/Round U-bolts w/4 nuts
 - (4) 3/8" - 16 Stainless carriage bolts - 3/4" long
 - (4) 3/8" - 16 Nylock nuts - zinc trivalent finish
 - (4) Stainless washers - 1" x .550" X .060" thick

SQUARE BRACKETS			ROUND BRACKETS		
\$135.14	LP399200-3	3" Brackets	\$135.14	LP399205-3	3" Brackets
\$135.14	LP399200-4	4" Brackets	\$135.14	LP399205-4	4" Brackets
\$135.14	LP399200-5	5" Brackets	\$135.14	LP399205-5	5" Brackets



DROP SHELF/ SPIRAL VENDING MACHINE/ GIVEAWAY KIT VENDING

- **100 KITS**
- EACH KIT INCLUDES:**
 - (1) Armor All® Protectant Sponge
 - (1) Wet Towel
 - (1) Little Trees® Black Ice

\$225.00	KRK1010	Kit
FREE	VE0158-10	Decal

NOT FOR SALE IN CALIFORNIA



DROP SHELF/ SPIRAL VENDING MACHINE/ GIVEAWAY KIT VENDING

- **100 KITS**
- EACH KIT INCLUDES:**
 - (1) 16" x 12" Blue Microfiber Towel
 - (1) Armor All Protectant Wipes (2 wipes per pouch)
 - (2) Wet Towel
 - (1) Little Trees Black Ice

\$277.89	KRK1050	Kit
FREE	VE0158-50	Decal

NOT FOR SALE IN CALIFORNIA

VENDING KITS



New!



CLEAN KIT 1 4-PIECE CAR CLEANING KIT VENDING

- 100 KITS PER CASE
- EACH KIT INCLUDES:
 - ((2) Glass Cleaner Towelettes (VSTAWC)
 - (1) Interior Cleaning Towelette (VS169)
 - (1) Quick Dry Hang Up Air Freshener (QBAF006)

\$220.00	QBCLEANKIT1	Kit
FREE	QBCLEANKIT1-DECAL	Decal



New!



CLEAN KIT 2 3-PIECE CAR CLEANING KIT VENDING

- 100 KITS PER CASE
- EACH KIT INCLUDES:
 - (1) 12 x 12 Microfiber Towel
 - (1) Interior Cleaning Towelette (VS169)
 - (1) 2oz. Quick Dry Glass Cleaner Spray Bottle

\$186.67	QBCLEANKIT2	Kit
FREE	QBCLEANKIT2-DECAL	Decal



New!



CLEAN KIT 3 4-PIECE CAR CLEANING KIT VENDING

- 100 KITS PER CASE
- EACH KIT INCLUDES:
 - (1) 12 x 12 Microfiber Towel
 - (1) Microfiber Cleaning Wand (VS170)
 - (1) 1oz. Quick Dry Cleanz All Interior Cleaner Spray Bottle
 - (1) Glass Cleaner Towelette (VSTAWC)

\$220.00	QBCLEANKIT3	Kit
FREE	QBCLEANKIT3-DECAL	Decal



New!



CLEAN KIT 4 4-PIECE CAR CLEANING KIT VENDING

- 100 KITS PER CASE
- EACH KIT INCLUDES:
 - (1) 12" x 12" Microfiber Towel (VS169)
 - (1) Interior Cleaning Towelette
 - (1) Quick Dry Hang Up Air Freshener (QBAF006)
 - (1) Glass Cleaner Towelette (VSTAWC)

\$186.67	QBCLEANKIT4	Kit
FREE	QBCLEANKIT4-DECAL	Decal

COMMON LAUREL VENDOR REPLACEMENT PARTS



MA850 COIN ACCEPTOR WITH LAUREL PLUG

- For all vendors

\$235.52 LP39964



VEND MOTOR ASSEMBLY WITH WIRE HARNESS

- For 3 column vendor

\$41.83 LP899A42



VEND MOTOR ASSEMBLY WITH WIRE HARNESS

- For 5 column vendor

\$65.00 LP599C24



MICROCOIN QL COIN ACCEPTOR WITH LAUREL PLUG

- For all vendors

\$286.71 LP399101



BLACK/RED SWITCH PAD FOR 3 & 5 COLUMN VENDOR

\$38.68 LP89920N



EMPTY SWITCH FOR 1 COLUMN VENDOR

\$8.39 LP39915



LED WINDOW (DIGIMAX STYLE) FOR ALL VENDORS

- Replacement red LED display window for Laurel Metal vending units with newer large DigiMax displays
- Dimensions: 1.344" x 3.125"

\$1.55 LP89978



DIGI-MAX CIRCUIT BOARD REPLACEMENT PARTS

- RED (3 & 5 columns)

\$294.10 LP89977



SLUGBUSTER COIN ACCEPTOR WITH LAUREL PLUG

- For all vendors

\$153.10 LP399102



VEND MOTOR CAM ASSEMBLY FOR 1 COLUMN VENDOR

\$26.80 LP399A10



COIN INSERT PLATE FOR ALL VENDORS

\$4.29 LP39963



WHITE RIBBON CABLE FOR 3 & 5 COLUMN VENDOR

\$8.75 LP59915



EMPTY SWITCH FOR 3 COLUMN VENDOR

\$8.39 LP89941



DIGI-MAX CIRCUIT BOARD REPLACEMENT PARTS

- BLUE (1 column.) - For Laurel Model 399 & 2599 DigiMax machines only
- CryptoPay credit card ready
- Large dot-matrix LED display with Language choices
- Retrofit kit for older green colored circuit boards includes new door along with the blue board - blue board fits into the same metal frame as the green board

\$294.10 LP399111

COMMON LAUREL VENDOR REPLACEMENT PARTS



MODEL 2100 MAGAZINE ASSEMBLY REPLACEMENT PARTS



• 1 column • \$0.25 - \$1.00 • Exact replacement part, no tweaks or adjustments

\$155.00 LP2101

MODEL 300 MAGAZINE ASSEMBLY REPLACEMENT PARTS

• 1 column • \$0.50 - \$3.00 • Exact replacement part, no tweaks or adjustments

\$155.00 LP300D1



SHELF ASSEMBLY WITH VEND MOTOR ASSEMBLY

• For 3 column electronic vendors

\$175.00 LP899E40



KNOB WITH SET SCREW REPLACEMENT PARTS



• For all Laurel vendors

\$6.25 LP2132



COIN BUTTON RETURN REPLACEMENT PARTS



• For all Laurel mechanical vendors

\$3.88 LP21119



LOCK & KEY FOR COIN BOX REPLACEMENT PARTS



• For all Laurel mechanical vendors

\$11.51 LP21133



COIN INSERT - US QUARTER FOR ALL VENDORS



\$27.91 CB0218



COIN BOX WITH LIP REPLACEMENT PARTS



• Fits 1 column \$0.25 - \$1.00 Laurel vendors
• 2 $\frac{3}{4}$ " W x 4" L x 2" D

\$13.57 LP21131



COIN BOX NO LIP REPLACEMENT PARTS



• Fits 1 column \$0.25 - \$1.00 & \$0.50 - \$3.00
• 4 oz. bottle vendor
• 3" W x 4" L x 2 $\frac{7}{8}$ " D

\$15.98 LP30069



COIN BOX REPLACEMENT PARTS

\$26.25	LP30A79	5 Column Mechanical
\$23.63	LP81A80	3 & 5 Column Electronic



RATCHET PAWL ASSEMBLY FOR MECHANICAL COIN MECHANISM



\$5.74 LP2123



RATCHET REPLACEMENT PARTS

• For 4 oz. bottle vendor - 1 column - \$0.50 - \$3.00

\$5.72 LP30031



RATCHET REPLACEMENT PARTS



• 1 column - \$0.25 - \$1.00

\$5.00 LP2145



COIN BOX DOOR REPLACEMENT PARTS

• For 3 column vendors - 3 $\frac{5}{8}$ " x 3 $\frac{1}{8}$ "

\$14.92 LP8196



COIN BOX DOOR REPLACEMENT PARTS

• For 5 column vendors - 4" x 3 $\frac{3}{8}$ "

\$14.92 LP3093



COIN INSERT PLATE REPLACEMENT PARTS

• 1 column \$0.25 - \$1.00 | 1 column \$0.50 - \$3.00
• Tire Foam/4 oz. bottle vendor

\$4.29 LP21126



STAINLESS SIDE BAR WITH FASTENERS

\$7.98 LP210064

COMMON LAUREL VENDOR REPLACEMENT PARTS



SIDE MOUNT BOX FOR CRYPTOPAY SWIPER REPLACEMENT PARTS

- Swiper NOT included
- Box can be mounted on left or right side (reversible)
- 16-gauge stainless steel - 5 $\frac{3}{8}$ " H x 3-5/16" W x 3-5/16" D

\$80.26 CPS3025



SIDE MOUNT BOX FOR CRYPTOPAY SWIPER AND LED7 REPLACEMENT PARTS

- Swiper & timer NOT included
- Box can be mounted on left or right side (reversible)
- Locks on top and bottom
- 16-gauge stainless steel - 11 $\frac{1}{4}$ " H x 5 $\frac{1}{4}$ " W x 3 $\frac{1}{2}$ " D

\$145.91 CPS3025-V



SIDE MOUNT BOX FOR CRYPTOTAP ONLY REPLACEMENT PARTS

- CryptoTap NOT included
- Brings convenient credit card pay abilities to your vacuums and more
- Locks on top and bottom
- 16-gauge stainless steel - 11 $\frac{1}{4}$ " H x 5 $\frac{1}{4}$ " W x 3 $\frac{1}{2}$ " D
- Mounts on left side or right side of bay meter or vacuum (reversible).

\$142.67 CPS3025-T



SIDE MOUNT BOX FOR CRYPTOTAP, CRYPTOPAY & LED6 OR LED7 REPLACEMENT PARTS

- Swiper, timer, and tap NOT included
- Locks on top and bottom
- 16-gauge stainless steel - 11 $\frac{1}{4}$ " H x 6 $\frac{3}{4}$ " W x 3 $\frac{1}{8}$ " D
- Use with the Dixmor LED6 or LED7 timer, and a CryptoPay Swiper or CryptoTap unit. It can be mounted on either side of your existing coin box (reversible)

\$200.00 CPS3025-VT



11" COIN MECHANISM REPLACEMENT PARTS

- \$0.25 - \$1.00
- 1 column vendors
- For Laurel model 2100

\$138.75 LP21101



13.5" COIN MECHANISM REPLACEMENT PARTS

- \$0.50 - \$3.00
- 1 column vendors
- For Laurel model 300

\$170.00 LP300D15



COIN MECHANISM REPLACEMENT PARTS

- Accepts US quarters

\$206.25	LP30D36	5 Column
\$174.99	LP81D36	3 Column



STAINLESS STEEL SECURITY FRAME REPLACEMENT PARTS

- 1 column \$0.50 - \$3.00
- 4 oz. bottle vendor

\$50.00 LP2163



SECURITY FRAME SET REPLACEMENT PARTS

- 5 column vendors
- Mechanical & electric

\$108.97 LP30A83



SECURITY FRAME SET REPLACEMENT PARTS

- 5 column vendors
- Mechanical & electric

\$70.51 LP3083MAX

SECURITY FRAME ONLY REPLACEMENT PARTS

- 3 column vendors
- 899 & 899-MAX 3 column vendors

\$96.15 LP8185MAX

COMMON LAUREL VENDOR REPLACEMENT PARTS



STAINLESS STEEL SECURITY FRAME WITH SIDE BARS

REPLACEMENT PARTS

- 1 column \$0.25 - \$1.00
- 1 column \$0.50 - \$3.00
- 4 oz. bottle vendor

\$61.72 LP21A63



TRANSFORMER

ELECTRONIC VENDOR REPLACEMENT PARTS

- Plug-in style transformer for 1 machine maximum
- 24V AC | 5mA output

\$31.65 LP39998



899-79 MDB CABLE

REPLACEMENT PARTS

- An OEM Laurel component
- For Laurel Metal 1, 3, 5- column vending units
- Connects the circuit board to CryptoPay

\$22.66 LP89979



TRANSFORMER

ELECTRONIC VENDOR REPLACEMENT PARTS

- For any electronic vendor 40VA | Power up to 3 vendors -
- Can be any mix of a single, 3, or 5 column machine
- 110V - 24V

\$32.13 TR0135



TOP SELLER!



PULL ROD ASSEMBLY WITH KNOB

MECHANICAL VENDOR REPLACEMENT PARTS

\$14.13	LP81A27	3 Column Vendors
\$14.92	LP30A26	5 Column Vendors



PULL ROD ASSEMBLY WITH KNOB

MECHANICAL VENDOR REPLACEMENT PARTS

- 1 column \$0.25 - \$1.00
- 1 column \$0.50 - \$3.00
- Tire Foam 4 oz. bottle vendor

\$15.50 LP2131

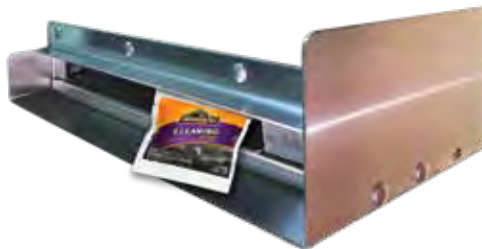

VENDOR BOTTOM GUARD

REPLACEMENT PARTS

- Vandal-proof the bottoms of your vending machines! Laurel protects from damage and theft.
- Easy to retrofit to your existing machine.
- Genuine laurel product for a guaranteed fit

\$75.00	LP30110	5 Column Vendors
\$75.00	LP81110	3 Column Vendors



VENDOR BOTTOM GUARD KIT

FOR SINGLE COLUMN VENDOR

- Vandal-proof the bottoms of your 3-column electrical and mechanical vending machines! Laurel Metal accessory protects from damage and theft. Easy to retrofit to your existing machine.
- Genuine Laurel product, guaranteed fit
- Protects your vending machines
- 1 column \$0.25 - \$1.00
- 1 column \$0.50 - \$3.00
- 4 oz. bottle vendor
- Tire Foam vendor

\$62.84 LP2100A139

VENDING MACHINES



YOU CAN ADD CRYPTOPAY TO THIS MODEL!

KLEEN-VIEW 18 SELECTION VENDING MACHINE

KLEEN-RITE VENDING EQUIPMENT



- 18 vending spirals
- Easy access
- Enhanced security
- Clear, organized, and professional visual display
- Stainless steel front
- Multi-price coin changer up to \$99.95
- Digital LED displays cost of vend and coins deposited
- Rear locking with ABUS padlock
- Front load, rear lock
- Security bar
- Lockable coin compartments
- On/off switch
- 4 tube changer (25¢ - 25¢ - 25¢ - \$1.00)
- 1 year control board warranty

SPECIFICATIONS:

- 34½" H x 31" W x 23½" D
- Front face plate: 37" W x 40" H
- Opening size: 32" W x 35¼" H
- Electrical service: 115V 2AMP primary & 24V 3.2 AMP secondary
- Shipping weight: 230 LBS.

OPTIONS:

- Front lock kit
- 4 direction \$1, \$2, & \$5 bill acceptor with \$300 capacity stacker
- Canadian coin acceptor compatible

\$3,823.50	MV29308	With Coin Acceptor Only
\$4,358.50	MV29310NC-CT	With Cryptopay and Bill Acceptor
\$4,235.50	MV29310	With Coin and Bill Acceptor
\$4,650.50	MV29310-C	With Cryptopay, Coin and Bill Acceptor

New!

KLEEN-VIEW REPLACEMENT PARTS



KLEEN-VIEW LED LIGHT KIT REPLACEMENT PARTS

- 24V, 12" white LED light
- 50,000 hours estimated life
- Replaces Xenon Light System in the RPD machines

\$49.99 MV50065

TOP SELLER!



24V BULB REPLACEMENT PARTS

\$6.30 MVBULB

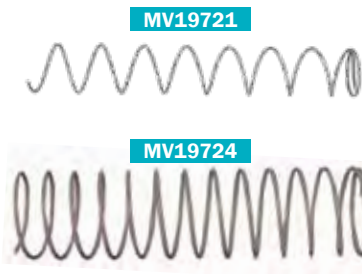

SPIRALS REPLACEMENT PARTS

\$19.23	MV19720	5 Small Spiral
\$19.23	MV19721	7 Small Spiral
\$19.23	MV19722	9 Small Spiral
\$19.23	MV19723	20 Small Spiral
\$19.23	MV19726	7 Large Spiral
\$19.23	MV19724	12 Large Spiral
\$19.23	MV19725	15 Large Spiral



MOTOR REPLACEMENT PARTS

\$30.77 MV19739



PCB CONTROL BOARD REPLACEMENT PARTS

\$461.52 MV50006



15 POSITION KEY PAD OVERLAY REPLACEMENT PARTS

\$8.92 MV19843D



KEY PAD REPLACEMENT PARTS

\$61.54 MV19843



15 POSITION DOOR DECAL REPLACEMENT PARTS

\$24.92 MV50058
\$62.50 MV50058-BL



TOUCH PAD DECAL REPLACEMENT PARTS

\$18.77 MV19733

VENDING MACHINES

KLEEN-VEND REAR LOAD VENDING MACHINES

KLEEN-VEND FROM KLEEN-RITE

KLEEN-VEND



4 SHELF/32 SELECTION VENDOR WITH BILL-ACCEPTOR

KLEEN-VEND FROM KLEEN-RITE

- 41" W x 44 $\frac{5}{8}$ " H x 38 $\frac{5}{8}$ " D
- Vend up to 32 items from 4 shelves
- Walk-by fault indicator
- Individual testing of the coin mechanism, coin hopper & each motor
- Per item pricing, makes change
- Mix & match motor position
- Door constructed of 12-gauge steel
- Rear serviceable
- Sensortron coin acceptor and Mars bill acceptor are standard
- Lexan® overlay provides years of attractive service
- Can be installed by 2 people without heavy equipment

TOP SELLER!

YOU CAN ADD CRYPTOPAY TO THIS MODEL!

\$6,241.94 KV28786 WITH Bill Acceptor



3 SHELF/24 SELECTION VENDOR

KLEEN-VEND FROM KLEEN-RITE

- State-of-the-art, through wall vendor built specifically for the car wash industry
- The Kleen-Vend uses a patented (No. 6,994,230) rear load design and coin pulse technology
- Built to last with lower maintenance costs and downtime
- Delivers maximum profits, performance, and security

YOU CAN ADD CRYPTOPAY TO THIS MODEL!

\$5,109.13	KV28790	WITHOUT Bill Acceptor
\$5,587.33	KV28788	WITH Bill Acceptor

KLEEN-VEND REPLACEMENT PARTS & ACCESSORIES



SHELF GUIDE SET

REPLACEMENT PARTS

- 1 RH, 1 LH

\$89.98 KVP623004



BUTTON INSERT

REPLACEMENT PARTS

- 9 pack selector

\$11.15 KVP60090



HUB ADAPTER

REPLACEMENT PARTS

- 10 pack

\$5.45 KVP626002



BALLAST

REPLACEMENT PARTS

\$40.32 KVP622005



COIN HOPPER

REPLACEMENT PARTS

\$136.70 KVP623201



SHELF DIVIDER W/ SPRING

REPLACEMENT PARTS

\$18.58 KVP621006



COIN CUP

REPLACEMENT PARTS

\$27.87 KVP621046



VENDOR CONTROLLER

REPLACEMENT PARTS

\$249.49 KVP623301

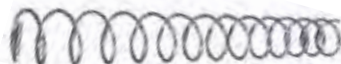

HELIX

KLEEN-VEND REPLACEMENT PARTS

\$25.23	KVP6270010	2.5" x 8
\$13.27	KVP627008	2.5" x 24
\$17.24	KVP627011	4" x 18
\$30.52	KVP627012	4" x 24



T-LOCK HANDLE KIT

REPLACEMENT PARTS

\$46.50 GS104845



GINSAN SENSORTRON

REPLACEMENT PARTS

\$154.29 CB0201



CPI TALOS VALIDATOR

REPLACEMENT PARTS

\$434.99 T612-U3E

VENDING

VENDORS FROM RAIN TUNNEL



YOU CAN ADD CRYPTO PAY TO THIS MODEL!



YOU CAN ADD CRYPTO PAY TO THIS MODEL!



MEGA-VENDOR I™ BY RAIN TUNNEL



- 45-55 selection dimensions - 39" W x 35" D x 72" H
- 39 selection dimensions - 35" W x 35" D x 72" H
- Will vend up to 45-55 items depending on the size of each product
- The MegaVendor creates many exciting new opportunities for the car wash owner
- Choose between Coinco (metal bezel) or CPI-Talos acceptors
- Can be programmed to accept tokens
- Free standing & flush mount security systems available

PRICE	PART #	ACCEPTOR	MODEL
\$6,325.00	MG90000-C	Coinco	52 Selection Non-Refrigerated
\$6,475.00	MG90000	CPI-Talos	
\$6,738.00	MG90010-C	Coinco	52 Selection Refrigerated
\$6,888.00	MG90010	CPI-Talos	
\$6,234.00	MG90001-C	Coinco	39 Selection Non-Refrigerated
\$6,384.00	MG90001	CPI-Talos	

MEGA-VENDOR II™ BY RAIN TUNNEL



- Consistent product delivery! Without it, little else matters. How many complaints does it take before someone damages your vending machine? Not many. With Sensit's Extra Sensory Perception, hang-ups and misloading are no longer a problem.
- 39" W x 72" H x 35" D
- 41-51 Selection
- 6 shelf combination drink, snack and product vending system
- Will vend 41-51 items depending on the size of each product
- The MegaVendor II features double pane heated glass and a variable speed high efficiency compressor
- Refrigerated
- Choose between Coinco (metal bezel) or CPI-Talos acceptors

PRICE	PART #	ACCEPTOR
\$7,962.00	MG90020-C	Coinco
\$8,112.00	MG90020	CPI-Talos

VENDORS FROM RAIN TUNNEL

RAIN TUNNEL VENDOR PARTS & ACCESSORIES



YOU CAN ADD CRYPTO PAY TO THIS MODEL!



PAYMENT METHODS ACCEPTED:
 Visa, Mastercard, Mastercard Pay Pass, Apple Pay, Samsung Pay, Android Pay, Moryx, EMVCo, UnionPay, Interac, ALIPAY, WeChat, FeliCia, Prepaid Cards, QR Codes, Barcodes

TOUCHSCREEN CASHLESS PAYMENT SOLUTION

MEGA-VENDOR PARTS & ACCESSORIES

- Hi-resolution touchscreen
- Voice interaction (two languages offered)
- Technician mode
- ARM, Cortex 32-bits (M4 + M7)
- High Security Encryption System: AES/DES
- External flash 64 MB, SD Card 4 GB, SD RAM 16 MB
- Anti-Vandal with Gorilla Glass
- Shock and tilt detector
- Monitoring and alert of Power down
- Decorative LED for Contact Smart Card slot

\$399.00 MGCRC-D-T



BOLT DOWN FOOT ASSEMBLY

MEGA-VENDOR PARTS & ACCESSORIES



- Set of 2
- Alleviates the issue of rocking, tipped and stolen machines - attaches with cement anchors

\$17.50 MG11000

HIGH CAPACITY CAN TRAY

MEGA-VENDOR PARTS & ACCESSORIES



- Replaces bottom tray in the Mega-Vendor® II & III
- Holds 120 cans in one tray and gives you back a 5th tray for car wash products!

\$601.91 MG24223

27 SELECTION MEGA-VENDOR® MINIVENDOR WITH COINCO

BY RAIN TUNNEL



- The MegaVendor Mini is for vending products not requiring refrigeration. Since it doesn't need insulation, it costs less. The Mini saves space, too! It's only 28½" wide and 29½" deep. In addition, the vendor has a more modern look and is available in black or gray. Every Mini comes with patented Sensit® Guaranteed Delivery System.
- Mega-Vendor vending systems are revolutionizing the method for selling items in unattended areas such as car washes, rest stops, golf courses, small airports, and more!
- The Mega-Vendor with a combination of "Guaranteed to Vend" Sensit Technology and physical security creates the opportunity to sell virtually any items that will physically fit in the machine. Items such as car washing supplies, snacks, road maps, cell phones, tire repair kits, etc. are currently being sold in the Mega-Vendor system.
- All Mega-Vendor models include a 3-year warranty on the electronic board and sensors and a 1-year warranty on the rest of the machine. Also included on all models, the Coinco Vantage Bill Acceptor (metal bezel) and a Coinco Coin Validator - which can be programmed to accept tokens.



VALIDATOR COVER

MEGA-VENDOR PARTS & ACCESSORIES

- Available for Coinco validators

\$103.52 MG22000C

ADDING ELECTRONIC PAYMENT ACCEPTANCE WILL RESULT IN AN INCREASE TO YOUR OVERALL REVENUE!

Credit card users spend anywhere from 30% to 50% more than cash customers on each transaction resulting in an increased amount of revenue per customers. Customers who use a credit card will wash more frequently because they are not tied to the cash and change in their possession.

PRICE	PART #	ACCEPTOR	MODEL
\$5,473.00	MG90050-C	Coinco	Black MiniVendor
\$5,623.00	MG90050	CPI-Talos	
\$5,473.00	MG90060-C	Coinco	Gray MiniVendor
\$5,623.00	MG90060	CPI-Talos	

VENDORS FROM RAIN TUNNEL



MEGA-VENDOR III® BY RAIN TUNNEL



The Mega-Vendor III is rated for outdoor use and has built in security features including: heavy gauge steel lock cover, triple pane heated glass protected by a polycarbonate panel, steel vandal panels, and a steel keypad cover built-in. The Mega-Vendor III is a glass front vending machine. The machine will vend 41 to 56 items depending on the size of each product. The Mega-Vendor III creates exciting new opportunities for the carwash owner.

- Refrigerated
- Mars and Coinco (metal bezel) acceptor options.
- The machine includes a 3 year warranty on the refrigeration, electronic board and sensors and a 1 year warranty on the rest of the machine.
- 39" W x 35" D x 72" H
- Glass front vending machine available in two different configurations: 6 product trays, or 4 product trays with 2 drink trays
- The machine vends 41 to 56 items depending on product size
- Mega-Vendor III is rated for outdoor use
- Built-in security features including: Heavy gauge steel lock cover, triple pane heated glass protected by a polycarbonate panel, steel vandal panels, and a steel keypad cover built in. These features combine to enable use without a security enclosure.

PRICE	PART #	ACCEPTOR	MODEL
\$8,853.00	MG90040-C	Coinco	WITH Drink Trays
\$9,003.00	MG90040	CPI-Talos	WITH Drink Trays
\$8,853.00	MG90030-C	Coinco	WITHOUT Drink Trays
\$9,003.00	MG90030	CPI-Talos	WITHOUT Drink Trays



YOU CAN ADD CRYPTOPAY TO THIS MODEL!

KLEEN-VEND START KIT

KLEEN-RITE CORP.



- 18 selection



PART #	ITEM	QTY
AR13040-1	Armor All 4oz. Protectant, Single	12
AR17234-1	Armor All 4oz. Auto Glass Cleaner, Single	12
AR17235-1	Armor All 4oz. Wheel & Tire Cleaner, Single	12
AR17236-1	Armor All 4oz. Extreme Tire Shine, Single	12
AR30800-1	Armor All Cleaning Sponge, Single	10
AR40040	Armor All 4oz. Tire Foam, 12/Case	1
DJMF1616B-1	TBDJ Microfiber Towel, 16" x 16", Blue, Single	10
PGA1116-1	Febreze Vent Clip, Midnight Storm, Single	4
PGA1969-1	Febreze Car Vent Clips, Auto Fresh Laundry, Single	4
SHAM100-1	The Original Shabby, Single	10
VS10155-1	Car Freshner Little Tree Black Ice, Single	12
VS10189-1	Car Freshner Little Tree New Car, Single	12
VS10324-1	Car Freshner Little Tree Caribbean Colada, Single	12
VS10800-1	Armor All Protectant Sponge, Single	10
VS702-1	Wet Towel, Single	10
VSK2550-1	White Truck Towel, Wrapped, Single	10
VSK2650-1	Blue Truck Towel, Wrapped, Single	10
VSKMF100BK-1	KR Big Boss Towel, 16" x 12" Single, Black	10

\$190.00

KRKVSTARTKIT

CHECK OUT THE NEXT PAGE FOR OUR RECOMMENDED PRODUCT PLANOGRAM

SUGGESTED PRODUCT PLANOGRAM FOR MEGA VENDORS



BIG BOSS TOWEL
12 UNITS/SHELF

VSKMF100 OR VSKMF100BK



ORIGINAL SHAMMY
9 UNITS/SHELF

SHAM100



WET TOWEL
12 UNITS/SHELF

VS702



ARMOR ALL PROTECTANT SPONGE
15 UNITS/SHELF

VS10800



ARMOR ALL CLEANING SPONGE
15 UNITS/SHELF

AR30800



DOCTOR JOE MICROFIBER TOWEL
15 UNITS/SHELF

DJMF1616B



FEBREZE FRESH LAUNDRY VENT CLIP
15 UNITS/SHELF

PGA1969



FEBREZE PLATINUM ICE VENT CLIP
15 UNITS/SHELF

PGA8813



FEBREZE LINEN & SKY VENT CLIP
15 UNITS/SHELF

PGA1113



FEBREZE HAWAIIAN ALOHA VENT CLIP
15 UNITS/SHELF

PGA1114



FEBREZE MIDNIGHT STORM VENT CLIP
15 UNITS/SHELF

PGA1116



BLACK ICE LITTLE TREE
32 UNITS/SHELF

VS10155



NEW CAR LITTLE TREE
32 UNITS/SHELF

VS10189



VANILLAROMA LITTLE TREE
32 UNITS/SHELF

VS10105



CARIBBEAN COLADA LITTLE TREE
32 UNITS/SHELF

VS10324



STRAWBERRY LITTLE TREE
32 UNITS/SHELF

VS10312



4 OZ. TIRE FOAM
7 UNITS/SHELF

AR40040



2 PACK LEATHER WIPES
18 UNITS/SHELF

AR17237



2 PACK CLEANING WIPES
18 UNITS/SHELF

AR17239



2 PACK GLASS WIPES
18 UNITS/SHELF

AR17240



2 PACK PROTECTANT WIPES
18 UNITS/SHELF

AR17238



WRAPPED TERRY TOWEL
18 UNITS/SHELF

VSKTT100W



WRAPPED BLUE CLOTH TOWEL
18 UNITS/SHELF

VSKBC100W



WRAPPED WHITE TRUCK TOWEL
18 UNITS/SHELF

VSK2550



WRAPPED BLUE TRUCK TOWEL
18 UNITS/SHELF

VSK2650



4 OZ. GLASS CLEANER SPRAY
7 UNITS/SHELF

SWGC



4 OZ. EXTREME TIRE SHINE
10 UNITS/SHELF

AR17236



4 OZ. AUTO GLASS CLEANER
12 UNITS/SHELF

AR17234



4 OZ. WHEEL & TIRE
10 UNITS/SHELF

AR17235



4 OZ. PROTECTANT
10 UNITS/SHELF

AR13040



SECURITY CAGES

FOR MEGA-VENDOR & MEGA-VENDOR® MINI

- Protects your Mega-Vendor and its contents
- All enclosures have a 3/8" polycarbonate standard plastic
- **SHIPS SEPARATELY FROM VENDORS**

\$2,500.00	MG90100	52 Selection Security Cage Free Standing	BLUE	FOR MEGA-VENDOR
\$2,500.00	MG90102	52 Selection Security Cage Free Standing	RED	
\$3,850.00	MG90100SS	52 Selection Security Cage Free Standing	STAINLESS STEEL	FOR MEGA-VENDOR MINI VENDOR
\$2,300.00	MG90106	27 Selection Security Cage Free Standing	SILVER	
\$2,500.00	MG90400	Front Service Stainless Steel Security Door	SILVER	

MEGA-VENDOR®
enclosures ship
separately from the
machines.



BILL ACCEPTOR WITH FLEXSTACK

PAYCOMPLETE/COINCO [PayComplete coinco](#)

- Accepts: \$1 - \$20 bills, four-way insertion
- Bezel type: Basic
- Cashbox size:
FlexStack - cashbox holds 200-500 bills
- Voltage: 34VDC
- Communication Interface: MDB
- Mounting orientation: Upstack
- Quick release bezel speeds installation and maintenance
- Superior water protection
- Optical stringing protection
- Attention grabbing impulse lights
- Streamlined bill path and intelligent bill transport software reduce jam conditions providing highest in-service time

\$387.84 **VX63B45US00**



TALOS BILL VALIDATOR

CPI

- Accepts: \$1 - \$20 Bills
- Bezel: Expanded
- Voltage: 24 VAC
- Orientation: Upstack
- Magazine Capacity: 500
- Features a modernized Light Bar Sensor that scans inserted bills with 6 wavelengths of light covering 99% of the banknotes surface enhancing accuracy ten-fold.

\$507.43 **T6T2-U5M**



MG20120-32

MEGA-VENDOR REPLACEMENT PARTS

MEGA-VENDOR PARTS & ACCESSORIES



MG20966



MG26931



MG24223

\$8.69	MG20120-07	7 item helix (tire foam)
\$8.69	MG20120-09	9 item helix (round sprays)
\$12.89	MG20120-32	32 item helix (flat air fresheners)
\$10.58	MG20613	Alpha-numeric location labels
\$53.48	MG20614	Alpha-numeric price labels
\$2.69	MG20966	Reduced depth Hub (black part between motor and helix)
\$16.11	MG22040	Numeric price sheets
\$9.19	MG21465-15	15 item packet coil
\$601.91	MG24223	High capacity can tray for MegaVendor II & III (replaces bottom tray in vendor - holds 120 cans)
\$515.52	MG26932	Control board with offset adapter plate PLEASE SPECIFY VENDING MACHINE SERIAL # WHEN ORDERING
\$10.00	MG21465-24	24 item helix (3/4" dia, 7/8" slot width)

RADDATZ VENDING MACHINES



LM30 HIGH SECURITY IN WALL VENDOR

RADDATZ

- Cabinet size: 52 ½" H x 32 ½" W x 25" D
- Weight: 550 lbs/249.476 kg
- 115 VAC - 4 AMP
- 30 selections with flexible configuration
- Various capacities (210 pieces shown)
- MDB electronics for worldwide use
- LED credit display
- Individual selection pricing
- Non-resettable cash & vend counter
- With bill and coin acceptor
- Bill validator accepts \$1, \$5, \$10 & \$20
- 24V DC vend motors
- Heavy steel construction
- Interchangeable spirals for product flexibility
- Dual T-handle and rear locking
- Adjustable wall brackets for installation
- Heavy 3/16" plexiglass or polycarbonate

\$5,058.99	MV29330	Rear Loading
\$5,058.99	MV29330FL	Front Loading

New!



YOU CAN ADD CRYPTOPAY TO THIS MODEL!



WM2 WALL MOUNTED VENDOR WITH COIN ACCEPTOR

RADDATZ

- Get reliable service and minimal malfunctions with Raddatz Product Development WM2 wall-mounted vending machines. Units feature interchangeable parts for customized configurations to suit your needs. Installation is fast and convenient!
- 32½" W x 34½" H x 13" D
- 115V AC - 3 Amps
- 24V DC vending motors
- 6 - 12 selections (9 standard)
- Individual pricing
- Static display
- Heavy stainless steel cabinet and door
- Hang-on wall mounting
- 2 T-handle locking system
- Easy-loading swivel trays
- Guaranteed Vend: Reliable service
- Interchangeable spirals: 5 to 20 different configurations per selection
- Accepts coins only, NO BILL ACCEPTOR IN THIS UNIT

\$2,817.99	MV29320
-------------------	----------------

DOES NOT INCLUDE BILL ACCEPTOR



YOU CAN ADD CRYPTOPAY TO THIS MODEL!



WM2 WALL MOUNTED VENDOR WITH COIN & BILL ACCEPTOR

RADDATZ

- Get reliable service and minimal malfunctions with Raddatz Product Development WM2 wall mounted vending machines. Units feature interchangeable parts for customized configurations to suit your needs. Installation is fast and convenient thanks to a wall mount design
- 32½" W x 34½" H x 13" D
- 115V AC - 3 Amps
- 24V DC vending motors
- 6 - 12 selections (9 standard)
- Static display
- 2 T-handle locking system
- Heavy stainless steel cabinet and door
- Hang-on wall mounting
- Easy-loading swivel trays
- Guaranteed vend: Reliable service
- Interchangeable spirals: 5 to 20 different configurations per selection
- Individual pricing (5¢- \$99.95, makes change)

\$3,170.64	MV29322
-------------------	----------------



YOU CAN ADD CRYPTOPAY TO THIS MODEL!

VENDING KITS



TOP SELLER VENDING KIT KLEEN-RITE KITS

- This kit includes the most popular Armor All and Car Freshner Little Tree vending products among car wash customers - the perfect way to fill up your new or current vending machine units
- (1) **AR30800** Armor All Cleaning Sponge Pack (100 case)
- (2) **AR40040** Armor All Tire Foam 4 oz. (12 case)
- (2) **VS10155** Little Trees Black Ice (72 pack)
- (1) **VS10311** Little Trees Wild Cherry (72 pack)
- (1) **VS10800** Armor All Original Protectant Sponge Pack (100 case)
- (1) **VS10105** Little Trees Vanilla (72 pack)
- (1) **VS10189** Little Trees New Car (72 pack)
- (1) **VS10312** Little Trees Strawberry (72 pack)

\$419.48 KRK1800

WHETHER YOU ARE PURCHASING YOUR FIRST VENDOR OR RESTOCKING YOUR EXISTING MACHINES, KLEEN-RITE'S VENDING KITS ARE A GREAT DEAL! EACH KIT CONTAINS BEST SELLING VENDING PRODUCTS TO DRIVE SALES AND INCREASE PROFITS AT YOUR CAR WASH.

Each kit includes over 400 Little Trees air fresheners in popular scents:

- Strawberry
- Wild Cherry
- New Car
- Vanilla
- Black Ice

In fact, we include a full 12 dozen of Black Ice alone as it is hugely popular and a known money maker! Each air freshener is in a clear vending pouch that's easy to open. This packaging allows for a clear view of the product when in a vending machine.

Car wash patrons often want to spruce up their wheels and interiors when they leave the bay. This kit includes several popular Armor All products that add that final detailing touch!

You'll get 100 of the Armor All Cleaning Sponge and 100 Original Protectant sponges. Both of these vending products are staples in the car care industry. Each sponge can vend for \$1.00, delivering a great profit! The kit also includes 24 count, 4 oz. cans of Armor All Tire Foam, a popular retail product sized to fit in vending machines.

This kit includes only the most popular vending products to ensure you see an excellent return on your investment. Each product is also available for sale on its own. This means it is easy to replenish your customers' favorites at any time.

Keeping these name-brand products front and center in your vendor will be sure to catch customers' eyes. Stock up now and encourage patrons to stay a little longer at your car wash!



DUE TO PRODUCT SIZE AND SHAPE, THIS KIT IS RECOMMENDED FOR USE IN GLASS FRONT SPIRAL VENDING MACHINES.





TOP-SELLING SIMONIZ® VENDING & CLEANING PRODUCTS



AUTO GLASS CLEANER

SIMONIZ FLAT VENDING BOTTLES

- 4 oz. flat bottle
- 24 bottles per case
- Fits in any drop-shelf vending machine
- Great for on-the-go windshield cleaning

\$41.68	SM300FLAT	Bottle
FREE	SMD300	Decal



TIRE SHINE

SIMONIZ FLAT VENDING BOTTLES

- 4 oz. flat bottle
- 24 bottles per case
- Fits in any drop-shelf vending machine
- Delivers deep shine while protecting from cracking and fading

\$41.68	SM200FLAT	Bottle
FREE	SMD200	Decal



WHEEL CLEANER

SIMONIZ FLAT VENDING BOTTLES

- 4 oz. flat bottle
- 24 bottles per case
- Fits in any drop-shelf vending machine
- Offers powerful cleaning without scrubbing

\$41.68	SM100FLAT	Bottle
FREE	SMD10	Decal



MULTI-SURFACE PROTECTANT

SIMONIZ FLAT VENDING BOTTLES

- 4 oz. flat bottle
- 24 bottles per case
- Fits in any drop-shelf vending machine
- Advanced UV blockers for protection

\$41.68	SM400FLAT	Bottle
FREE	SMD400	Decal



MULTI-PURPOSE CLEANER

SIMONIZ FLAT VENDING BOTTLES

- 4 oz. flat bottle
- 24 bottles per case
- Fits in any drop-shelf vending machine
- Suitable for use on a multitude of interior vehicle surfaces

\$41.68	SM500FLAT	Bottle
FREE	SMD500	Decal



ONE STEP POLISH

SIMONIZ FLAT VENDING BOTTLES

- 4 oz. flat bottle
- 24 bottles per case
- Fits in any drop-shelf vending machine
- Use on paint, glass, chrome
- No residue on unpainted trim or decals

\$41.68	SM600FLAT	Bottle
FREE	SMD600	Decal



CLEANING WIPE PACKS

SIMONIZ

- 20 wipes per pouch
- 24 pouches per case
- Cleans dash, vinyl, and fabric surfaces
- A pleasant citrus-powered scent
- Heavy-duty wipe feel
- Absorbs grease and dirt
- Resealable packaging

CLEANING WIPES		
\$30.03	SM825	Wipes
FREE	SMD825	Decal



GLASS WIPE PACKS

SIMONIZ

- 20 wipes per pouch
- 24 pouches per case
- Fast drying, streak free, and waterless
- Pre-moistened
- Heavy-duty feel
- Resealable packaging

GLASS WIPES		
\$30.03	SM800	Wipes
FREE	SMD800	Decal



WAX PAD APPLICATOR

SIMONIZ

- 100 pads per case
- Each pad measures 4"
- FREE single-column vendor decal
- Padded terry applicator is great for wax application and interior dressing
- Use corners of square shape for hard-to-reach areas

\$68.43	SM725	Sponge
FREE	SMD725	Decal

FREE SIMONIZ® PRODUCTS!!!

See the "vendor deals" pages at the end of this section for details on great vending deals!



PRODUCTS ARE NOT FOR EXPORT

ARMOR ALL® TOP-SELLERS



PROTECTANT SPONGE PACK

ARMOR ALL FILLED SPONGE



Our proprietary formula cleans away dirt, dust and debris, fights aging, fading and cracking, while enhancing your vehicle's deep rich look.

- **Note:** Use a cleaning product first, and then follow up with protectant to protect surfaces.
- 100 per case
- Provides UV protection
- Helps keep surfaces looking like new
- Renews and revitalizes vinyl, rubber, and plastic
- Rich, non-greasy finish to dashes/interior surfaces
- **FREE** single-column vendor decal
- Fights aging, fading and cracking
- Enhances your vehicles deep, rich look
- Cleans, shines and protects plastic, vinyl and rubber
- Helps protect against UV and oxidation

\$61.25	VS10800	Sponge	FREE	ARD100	Decal
FREE	DEDSAA		FREE	DEDSAA	Overlay



CLEANING SPONGE PACK

ARMOR ALL FILLED SPONGE



- Get that natural, "just detailed" look with the Armor All cleaning sponge. Meticulously engineered for your customers' needs. This convenient sponge lifts away dirt and debris without harming delicate automotive surfaces. Great for the dash, vinyl, fabric, carpet, consoles, leather, and more.
- Won't dry out, damage, or fade automotive surfaces
- 100 per case
- **FREE** single-column vendor decal

\$61.25	AR30800	Sponge	FREE	ARD150	Decal
FREE	DEDSAC		FREE	DEDSAC	Overlay



ULTRA SHINE TIRE & TRIM SHINE SPONGE

ARMOR ALL



- Easy and effective way to shine and rejuvenate your tires, weathered plastic and rubber trim. Offers long-lasting shine and UV protection and is safe for car exterior rubber, plastic, and vinyl surfaces.
- Eliminates the risk of overspray, drips, or sling
- Get tires and rubber trim looking like new again with this convenient sponge
- Please note that tires and trim should be cleaned before use. Since they're pre-moistened, they're ready to use; simply wipe on and enjoy the shine!
- Sponge dimensions: 3" x 4¾" | 100 single wrapped sponges per case

\$83.71	AR18276	Sponge	FREE	ARD276	Decal
FREE	DEDS18276		FREE	DEDS18276	Overlay



PROTECTANT SPRAY

ARMOR ALL SPRAYS



- 4 oz. bottles - 24 bottles per case
- Fights aging, fading and cracking
- Provides UV protection
- Cleans, shines and protects plastic, vinyl and rubber
- Helps keep surfaces looking like new with a medium-shine finish
- **PLEASE NOTE - These bottles WILL NOT fit in a Laurel Drop Shelf Vendor**
- **SOLD BY THE CASE ONLY**
- **FREE** single-column vendor decal

\$38.17	AR13040	Spray	FREE	ARD123	Decal
----------------	----------------	-------	-------------	---------------	-------



TIRE FOAM

ARMOR ALL SPRAYS



- 4 oz. - 12 cans per case
- Powerful cleaning for a deep-black look
- Intense foam activates on contact, floating dirt away without scrubbing
- Conditioners nourish and restore your tires' natural deep-black look
- Our fastest drying formula yet
- **FREE** single-column vendor decal

\$18.44	AR40040	Spray	FREE	ARD200	Decal
----------------	----------------	-------	-------------	---------------	-------



ARMOR ALL®

PRODUCTS ARE NOT FOR EXPORT



EXTREME TIRE SHINE

ARMOR ALL

- 4 oz. bottles - 24 bottles per case
- Extra gloss enhancers for intense, mirror-like shine
- Conditions, nourishes, and preserves tires' rich black look
- Protects from harmful elements that can cause cracking and fading



\$41.27	AR17236	Bottles
FREE	DEDS17236	Overlay
FREE	ARD503	Decal



MULTI-PURPOSE CLEANER

ARMOR ALL

- 4 oz. bottles - 24 bottles per case
- All-in-one cleaning solution for that "just detailed" look
- Effective for the whole car: dash, vinyl, fabric, carpet, clear plastic, console and more
- Easily removes tough dirt, dust and grime



\$41.27	AR17233	Bottles
FREE	DEDS17233	Overlay
FREE	ARD500	Decal



AUTO GLASS CLEANER

ARMOR ALL

- 4 oz. bottles - 24 bottles per case
- Delivers a crystal clear, streak-free shine to your automotive glass surfaces
- Removes filmy residue, road grime, bugs, fingerprints and more
- Ammonia-free formula



\$41.27	AR17234	Bottles
FREE	DEDS17234	Overlay
FREE	ARD501	Decal



WHEEL & TIRE CLEANER

ARMOR ALL

- 4 oz. bottles - 24 bottles per case
- Triple-Action Formula dissolves grease, road grime AND brake dust
- Reveals brilliant shine
- Safe for wheels when used as directed



\$41.27	AR17235	Bottles
FREE	DEDS17235	Overlay
FREE	ARD502	Decal



CLEANING WIPES

ARMOR ALL

- 2 wipes per pack - 100 packs per case
- Powerful cleaning for automotive surfaces; dash, vinyl, carpet and more
- Convenient and disposable
- Natural matte finish

\$84.12	AR17239	Wipes
FREE	DEDS17239	Overlay
FREE	ARD506	Decal



LEATHER WIPES

ARMOR ALL

- 2 wipes per pack - 100 packs per case
- Cleans, conditions and protects leather surfaces
- Powerful blocking agents help protect against stains, cracking & fading

\$84.12	AR17237	Wipes
FREE	DEDS17237	Overlay
FREE	ARD504	Decal



GLASS WIPES

ARMOR ALL

- 2 wipes per pack - 100 packs per case
- Incredible clarity and shine with no streaking or hazing
- Residue-free and ammonia-free
- Safe for auto glass and tinted glass when used as directed

\$84.12	AR17240	Wipes
FREE	DEDS17240	Overlay
FREE	ARD507	Decal



PROTECTANT WIPES

ARMOR ALL

- 2 wipes per pack - 100 packs per case
- Engineered with proven protection and shine
- Cleans, shines and protects plastic, vinyl and rubber from UV damage
- Fights aging, fading, and cracking

\$84.12	AR17238	Wipes
FREE	DEDS17238	Overlay
FREE	ARD505	Decal

VENDING

MOTHERS®
Polishes+Waxes+Cleaners

MOTHERS® VENDING PRODUCTS



INSTANT DETAILER

MOTHERS

- Provides a sparkling showroom shine! Best used as a touch-up solution when a finish needs some attention, this formula clears layers of dust, removes fingerprints and smudges, and hides minor imperfections and spider-webbing. Break out this product when a ride needs to look freshly detailed in a short amount of time!
- 3.4 oz bottle - 24 bottles per case
- Quick results
- Remove dust, smudges, fingerprints, and other minor imperfections

\$48.88 MD08205



PROTECTANT SPRAY

MOTHERS

- Preserves and protects for 30 days! Mothers Protectant is a penetrating UV blocker, effective on rubber, vinyl, plastic and fiberglass. Formulated to recondition and maintain the original condition and appearance of dashboards, bumpers, trim, tires and more. Protectant isn't an oily surface coating film. It's an ozone and smog resisting, UV shielding penetrant and a preservation agent that works on just about any uncoated plastic or rubber.
- 3.4 oz bottle - 24 bottles per case
- UV protection
- Use on a variety of surfaces like rubber, vinyl, plastic, and fiberglass

\$43.57 MD05305



TOTAL INTERIOR DETAILER

MOTHERS

- Easy to keep that fresh "new car" look and smell - simply spray and wipe on virtually any surface inside your vehicle, including your dash, glass and screens
- Ammonia-free formula that uses micro-emulsifying agents and biodegradable surfactants to quickly dissolve dirt, oily film and fingerprints
- 3.4 oz bottle - perfect for vending and retail sales
- 24 bottles per case

\$48.88 MD05435



GLASS & SURFACE CLEANER

MOTHERS

- Quickly removes tough grime, dirt, oily film, and fingerprints from virtually any surface, leaving behind a sparkling clean, streak-free shine. This pro-strength, ammonia-free formula effectively cleans glass, mirrors, plastic, and chrome, yet it's safe for delicate window tint, gauges, GPS screens, smartphones, tablets, touch screens and other displays. It's also great for home use on windows, countertops, appliances, TVs, and monitors.
- 3.4 oz bottle - 24 bottles per case
- Ammonia-free formulation
- Streak-free shine

\$48.88 MD06605

GLASS CLEANER



GLASS CLEANER FOAM SPRAYWAY

- 4 oz. can | 24 per case
- For windows, mirrors, windshields and other glass surfaces
- It effectively dissolves dirt, grease, grit, and grime. The heavy-duty foam clings to vertical surfaces and guaranteed to leave no film.
- Contains perfume-grade alcohol for best performance - leaves behind a clean, fresh fragrance
- Ammonia-free

\$49.40 SWGC Spray Can
FREE VE0127 Single Column Decal



GLASS WIPES

BLUEMAGIC

- 12 per case
- 25 towelettes per pack
- Streak-free
- Safe for tinted glass!
- Peel-and-seal pouch
- Pre-scented

\$35.21 VSNA250

BLUEMAGIC® VENDING PRODUCTS



AUTO GLASS CLEANER BLUEMAGIC



Auto Glass Cleaner removes road film and blinding smears from your vehicle's windows with ease. These disposable wipes can be used on both the interior and exterior of your windows and never leave a mess behind. These wipes are an excellent addition to your car wash vending program!

- 100 per case
- Removes road film & blinding smears
- Interior & exterior use
- Disposable and mess-free
- **FREE VENDING DECALS AVAILABLE**

\$52.50	VSNA10C	Towels
FREE	DEV25	1 Column Decal
	DEDSAG	4" x 10" Overlay



BLACK JACK THICK SILICONE SPONGE BLUEMAGIC

- 24 or 100 per case
- Ready-to-use sponge
- Makes tires and trim look like new - mess-free and disposable!
- **FREE VENDING DECALS AVAILABLE!**

\$22.66	VSNA27	24 Per Case
\$94.38	VSNA27C	100 Per Case
FREE	DEV35	1 Column Decal
	DEDSBJ	4" x 10" Overlay



BUG & TAR REMOVER READY-TO-USE TOWEL BLUEMAGIC

- 24 or 100 per case
- Ready-to-use towel
- Safely removes bugs, tar, oil, asphalt, road film and tree sap from automobile paint, chrome and glass
- **FREE VENDING DECALS AVAILABLE!**

\$11.33	VSNA19	24 Per Case
\$47.19	VSNA19C	100 Per Case
FREE	DEV19	1 Column Decal
	DEDSBTR	4" x 10" Overlay



NEVER FOG READY-TO-USE TOWEL BLUEMAGIC

- 24 or 100 per case
- Ready-to-use towel
- Year-round fog shield for interior, auto & home glass. Mess-free and disposable
- **FREE VENDING DECALS AVAILABLE!**

\$11.33	VSNA28	24 Per Case
\$47.19	VSNA28C	100 Per Case
FREE	DEV40	1 Column Decal
	DEDSNF	4" x 10" Overlay



VINYL'N MORE CLEANER BLUEMAGIC

- 24 or 100 per case
- Ready-to-use towelette
- Safe for all surfaces
- Mess-free
- **FREE VENDING DECALS AVAILABLE!**

\$11.33	VSNA16	24 Per Case
\$47.19	VSNA16C	100 Per Case
FREE	DEV16	1 Column Decal
	DEDSVC	Overlay



VINYL'N MORE PROTECTANT BLUEMAGIC

- 24 or 100 per case
- Ready-to-use towelette
- Safe for all surfaces
- Restores, preserves & moisturizes
- **FREE VENDING DECALS AVAILABLE!**

\$11.33	VSNA15	24 Per Case
\$47.19	VSNA15C	100 Per Case
FREE	DEDSVP	4" x 10" Overlay

VENDING



BLUEMAGIC® VENDING PRODUCTS



JUST FOR LEATHER CLEANER BLUEMAGIC

- 24 or 100 per case
- Ready-to-use towelette
- Prevents premature aging with all-natural ingredients
- Restores, preserves & moisturizes all leathers

\$11.33	VSNA18	24 Per Case
\$47.19	VSNA18C	100 Per Case
FREE	DEV18	1 Column Decal
FREE	DEDJFL	Overlay



JUST FOR LEATHER CONDITIONER BLUEMAGIC

- 24 or 100 per case
- Ready-to-use towelette
- Prevents premature aging with all-natural ingredients
- Restores, preserves & moisturizes all leathers

\$11.33	VSNA17	24 Per Case
\$47.19	VSNA17C	100 Per Case
FREE	DEV17	1 Column Decal
FREE	DEDSL	Overlay



FOUR PEAKS® VENDING PRODUCTS



CLEANING WIPES FOUR PEAKS

- 30 wipes per package - 7 packages per case
- Wipe Size: 7" x 8"
- Removes dirt and dust
- Convenient, easy-to-use
- Resealable package
- Cleans rubber, vinyl, plastic

\$14.15 **GPMI30110**



PROTECTANT WIPES FOUR PEAKS

- 30 wipes per package - 7 packages per case
- Wipe Size: 7" x 8"
- Prevents UV damage
- Convenient, easy-to-use
- Cleans, shines, protects
- Resealable package

\$14.15 **GPMI30111**



GLASS WIPES FOUR PEAKS

- 30 wipes per package - 7 packages per case
- Wipe Size: 7" x 11"
- Ammonia-free
- Convenient, easy-to-use
- Resealable package
- Streak-free

\$14.15 **GPMI30113**



LEATHER WIPES FOUR PEAKS

- 30 wipes per package - 7 packages per case
- Convenient, easy-to-use
- Resealable package
- Clean, condition, protect
- Wipe Size: 7" x 8"

\$14.15 **GPMI30112**

ORIGINAL SHAMMY TOWELS

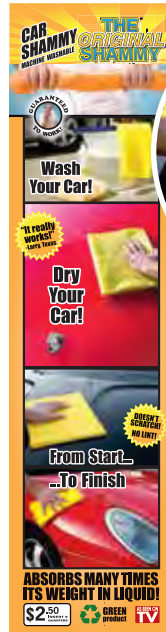

COUNTLESS DRIVERS COME TO YOUR BUSY CAR WASH EVERY DAY - HOW MANY OF THEM BRING A TOWEL?

Chances are that few do. Take advantage of this great money making opportunity by stocking your vending machines with the Original Shammy! You'll find that many customers actually prefer the convenience and performance of the Original Shammy, instead of having to remember to bring (and wash!) a towel from home.

The Original Shammy is a unique, reusable and disposable product that can hold up to 21 times its own weight in liquid! Simply wipe it over a wet surface and watch the water disappear. When saturated, the Original Shammy can be wrung out and used again.

Made of a soft, non-abrasive material, the Original Shammy will not scratch vehicle surfaces. It's perfect for washing and drying vehicle bodies, windshields, trim, and mirrors. The Original Shammy even works when polishing cars - it's that gentle.

Each case includes 120 assorted blue, orange, and yellow Original Shammy towels in individual wrapping. Rest assured that while the color may vary, the quality does not! Every Original Shammy performs exactly the same way and delivers remarkable water-capturing capabilities. FREE decals and overlays are available to advertise this product on your vending machines, too! Suggested vend price is \$2.25 per Shammy. This low price point is attractive to customers, encouraging sales, while still bringing your car wash an additional \$1.56 in profit per case sold!



Sustainability-focused customers will like that they can machine wash - and even bleach - their new Original Shammy. Its lightweight design is perfect to stow in the car for future car wash trips or even wiping up accidental spills. Likewise, busy customers will also love the Original Shammy's disposability - they'll know they can rely on your car wash to offer an Original Shammy for purchase at every visit. It's truly the product that pleases everyone!

ADD THIS MONEY-MAKING PRODUCT TO YOUR VENDING MACHINE TODAY AT A GREAT LOW PRICE!

THE ORIGINAL SHAMMY VENDING TOWELS



- Unfolded Original Shammy measures 12.5" x 16.75"
- 120 per case
- Individually wrapped and easy to vend
- Eye-catching, colors - assorted orange, blue & yellow
- Absorbs up to 21 times its weight in liquid
- Appropriate for washing, drying, or polishing vehicles
- Non-abrasive, will not leave scratches
- Machine washable and bleachable
- Easily disposable
- Offers great customer convenience
- Fantastic return on investment and profit with every case

\$135.19	SHAM100	Shammy
FREE	DEDS100	Overlay
FREE	VE0152	Decal

VENDING PRODUCTS



MICROFIBER DETAILING CLOTH

MAGNA SHINE



- 72 towels per case - 12" x 12"
- Magna Shine car wash towels are perfect for removing streaks, haze, dust, and wax residue off any surface like a magnet. They're great for wiping off fingerprints that collect on infotainment screens as well as cellphones and glasses. Magna Shine towels are ultra-soft and will not scratch sensitive surfaces.

\$80.76	MFT21836
DECAL	VE0108
OVERLAY	DEDS108



ALCOHOL-FREE DASHWIPE

PROMO CAR CARE



- DashWipes are a low-cost, high-impact promotional item for your car wash business! These wipes are alcohol-free, premoistened paper towels that allow customers to quickly wipe down interior surfaces in their vehicle. Each wipe is packaged in its own plastic wrap, so they stay moist and are easy to hand out to customers.
- Single use paper wipe in a plastic wrap
- Wipe measures 20cm x 25cm
- Excellent courtesy item for customers
- 1000 wipes per case
- Lemon scent
- Alcohol-free

\$69.99	TDASH-12
----------------	-----------------



HEALTH-E-WIPES HAND AND SURFACE WIPES

PROMO CAR CARE

- 1000 per case
- Isopropyl Alcohol wipes

\$129.00	MC7088
-----------------	---------------



HUGE & HEFTY PAPER TOWELS

J.E. ADAMS



- 18½" x 28"
- 250 per case

\$60.35	VST1502	Towel
FREE	DEA8420-1	Decal



LIFESTYLES CONDOMS

LIFESTYLES

- 72 per case
- FREE DECAL!

\$18.50	COND-1L	Condoms
FREE	DECONDOM	Decal

TOP-SELLING CAR WASH TOWELS



WHITE SUPER TRUCK TOWEL DECAL
VENDOR READY CAR WASH TOWELS

FREE VEO135



WHITE SUPER TRUCK TOWEL

VENDOR READY CAR WASH TOWELS



- One of our most popular car wash towels. These towels are thick and soft and won't streak your car wash customer's automobile. Whether these towels are sold in a car wash vending machine or given as a freebie in your car wash detail area, customers love the thick absorbent qualities of these towels.
- 19½" x 26½" • 200 per case
- Folded • Bulk packed

\$35.59 VSK2500

WHITE WRAPPED PAPER TOWEL

VENDOR READY CAR WASH TOWELS



- 19½" x 26½" • 200 per case • Bulk packed
- Folded • Extra absorbent

\$42.70 VSK2550

THESE POPULAR TOWELS ARE A GREAT WAY TO INCREASE PROFITS AT YOUR WASH!!!



BLUE SUPER TRUCK TOWEL DECAL
VENDOR READY CAR WASH TOWELS

FREE VEO138

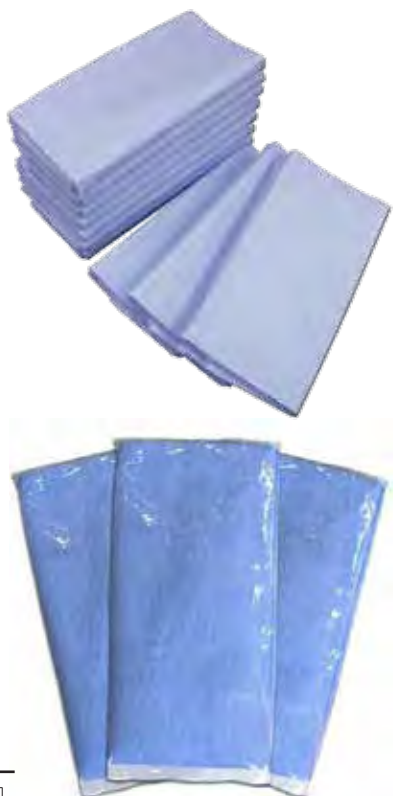

BLUE SUPER TRUCK TOWEL

VENDOR READY CAR WASH TOWELS



- Car wash towels made from soft, absorbent blue paper. These towels are perfect for your car wash vending machines and auto drying areas. These car wash towels are the most economical towels in the car wash industry and can be resold from \$0.50 to \$1, helping increase profits at your car wash operation.
- 19½" x 26½" • 200 per case
- Folded • Bulk packed

\$35.59 VSK2600

BLUE WRAPPED PAPER TOWEL

VENDOR READY CAR WASH TOWELS



- 19½" x 26½" • 200 per case • Folded
- Bulk packed • Extra absorbent

\$42.70 VSK2650

VENDING

KLEEN-RITE CORP.

KLEEN-RITE CAR WASH TOWELS



BIG BOSS MICROFIBER VENDING TOWEL

KLEEN-RITE CORP.

- 100 towels per case
- Folded & wrapped - Vendor ready!
- FREE DECALS AVAILABLE

\$61.99	VSKMF100BK	Towel
FREE	DEDSKRMF-BK	Overlay

WHITE MICROFIBER VENDING TOWEL

KLEEN-RITE CORP.

- 100 per case
- 16" x 12"
- Clean faster - easier - safer!
- Eliminate swirls and scratches!
- Dries 10 times faster than regular rags
- Folded & wrapped
- FREE DECALS AVAILABLE

\$79.99	VSKMF100W	Towels
FREE	DEDSMF-W	Overlay



BIG BOSS MICROFIBER VENDING TOWEL

KLEEN-RITE CORP.

- 100 per case
- 16" x 12" blue microfiber towel
- Clean faster - easier - safer!
- Eliminate swirls and scratches!
- Dries 10 times faster than regular rags
- Folded & wrapped
- FREE DECALS AVAILABLE

\$61.99	VSKMF100	Towel
FREE	DEDSKRMF	Overlay
FREE	VE0121	1 Col. Decal



BIG BOSS XL MICROFIBER VENDING TOWEL

KLEEN-RITE CORP.

- 100 per case
- 16" x 16" microfiber towel
- Folded & wrapped
- FREE OVERLAYS AVAILABLE

\$77.79	KRMF1616Y	Yellow
\$77.79	KRMF1616B	Blue
\$77.79	KRMF1616O	Orange
\$77.79	KRMF1616R	Red
\$77.79	KRMF1616G	Green



FLAT PACKED TERRY CLOTHS

KLEEN-RITE CORP.

- 12 per pack

PRICE	PART #	COLOR	TYPE
\$19.68	VSKT350B	Blue	QUALITY GRADE 3.5 LB • 16" x 27"
	VSKT350G	Green	
	VSKT350R	Red	
\$18.02	VSKT350W	White	PREMIUM GRADE 3 LB • 15" x 25"
	VSKT300B	Blue	
	VSKT300G	Green	
	VSKT300R	Red	
\$13.85	VSKT300W	White	ECONOMY GRADE 3 LB • 16" x 27"
	VSKDTNB	Navy	
	VSKDTG	Green	
	VSKDTR	Red	
	VSKDTW	White	

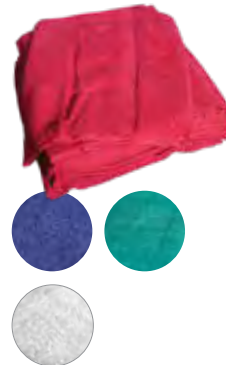

WRAPPED MICROFIBER VENDING TOWELS

TOWELS BY DOCTOR JOE



- 100 per case • 16" x 16"

PRICE	PART #	COLOR	FREE OVERLAY
\$76.99	DJMF1616B	Blue	DEDSMF-BL
\$76.99	DJMF1616G	Green	DEDSMF-G
\$76.99	DJMF1616Y	Yellow	DEDSMF-Y
\$76.99	DJMF1616O	Orange	DEDSMF-O
\$76.99	DJMF1616R	Red	DEDSMF-R



KLEEN-RITE CAR WASH TOWELS

KLEEN-RITE CORP.

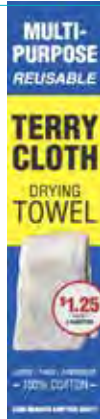

FOLDED WHITE TERRY CLOTH TOWEL

KLEEN-RITE CORP.



- Available in 100 count folded or 100 count wrapped
- 14" x 18"
- Soft, durable, machine washable
- Reusable
- 100% cotton

\$46.72	VSKTT100	100 Count
\$57.52	VSKTT100W	100 Count Wrapped
FREE	VE0151	1 Column Vendor Decal



BIG BLUE TOWEL - FOR ENORMOUS JOBS!

KLEEN-RITE CORP.



- Specially folded for perfect fit in glass front vendors
- Folded and ready-to-go - No refolding necessary
- New logo bags for more powerful display
- Absorbs 10x its weight
- 19½" x 40"
 - 150 per case
- \$1.00 vend brings back \$150.00
 - 75¢ brings back \$112.50

\$45.42	VSKB2040	Bulk Towel
\$61.18	VSKB2040W	Wrapped Towel
FREE	VE0136	1 Column Vendor Decal



BIG WHITE TOWEL - FOR ENORMOUS JOBS!

KLEEN-RITE CORP.



- Specially folded for perfect fit in glass front vendors
- Folded and ready-to-go - No refolding necessary
- New logo bags for more powerful display
- Absorbs 10x its weight
- 19½" x 40"
 - 150 per case
- \$1.00 vend brings back \$150.00
 - 75¢ brings back \$112.50

\$45.42	BWT1503	Bulk Towel
\$54.42	BWT1503W	Wrapped Towel
FREE	DEBWT	1 Column Vendor Decal



FOLDED BLUE CLOTH VENDING TOWEL

KLEEN-RITE CORP.



- 100 per case
- 17" x 24"
- Machine washable with a durable rolled-edge hem making this towel reusable
- Soft, durable and absorbent 100% cotton
- This wash cloth's thick pile makes it great for areas where absorbency is crucial

\$53.68	VSKBC100	100 Count
\$57.66	VSKBC100W	100 Count Wrapped
FREE	VE0150	1 Column Vendor Decal

VENDING

KLEEN-RITE CORP.

KLEEN-RITE CAR WASH TOWELS



\$0.25 WHITE BULK TOWELS

KLEEN-RITE CORP.

- 19½" x 18"
- 250 per case

\$30.88 VSK2400



\$0.25 BLUE BULK TOWELS

KLEEN-RITE CORP.

- 19½" x 18"
- 200 per case

\$26.27 VSK2200



\$0.50 BULK ECONOMY TOWEL

KLEEN-RITE CORP.

- 19½" x 28½"
- 200 per case

\$29.63 VSKE50



\$0.50 BULK WHITE SCRIM TOWEL

KLEEN-RITE CORP.

- 19½" X 28½"
- 250 per case

\$38.10 VSK1100



\$0.25 BULK WHITE SCRIM TOWEL

KLEEN-RITE CORP.

- 19½" x 18"
- 250 per case

\$28.69 VSK1000



\$0.50 WRAPPED NYLON SCRIM TOWEL

KLEEN-RITE CORP.

- 19½" X 28½"
- 250 per case

\$41.79 VSK1150



\$0.25 WRAPPED NYLON SCRIM TOWEL

KLEEN-RITE CORP.

- 19½" X 18"
- 250 per case

\$31.21 VSK1050



\$0.25 INDIVIDUALLY WRAPPED TOWELS

KLEEN-RITE CORP.

- 19½" x 18"
- 200 per case

\$34.81 VSK2250



\$0.50 BIG BLUE KLEEN-SHAMS

KLEEN-RITE CORP.

- 150 per case
- 17½" x 29½"
- **FREE VENDING DECAL!**

\$37.47	VSK4070	18" x 28" Wrapped
\$31.05	VSK4075	18" x 28" Unwrapped
FREE	VE0155	1 Column Decal



BULK BIG BLUE KLEEN-SHAMS

KLEEN-RITE CORP.

- 200 per case
- 17½" x 18"
- **FREE VENDING DECAL!**

\$32.33	VSK3065	Shams
FREE	VE0155	1 Column Decal

CAR WASH TOWELS



FOLDED BLUE-SHAM®

AMERICAN TEXTILE

- These soft yet durable Blu-Sham car wash towels are great for use on cars, vans, and trucks. Perfect for cleaning windshields, polishing chrome, and drying cars. These folded blue towels are made of fiber paper and they are reusable.
- 28" x 17"
 - 150 per case
 - Vendor ready
- Brings back \$75
 - **NOT WRAPPED**
 - **FREE DECAL!**

\$37.85	VSB4075	Sham
FREE	VE0105	\$0.50 Decal
	VE0106	\$0.75 Decal

NOT WRAPPED



\$0.25 FOLDED BLUE-SHAM®

AMERICAN TEXTILE

- The most economical towels on the car wash market. Offer your customers these multi-purpose towels to dry their vehicles, clean their windshields and detail their cars. A great addition to your car wash vending machines!
- 17" x 18"
 - Brings back \$50
 - 200 per case
- **NOT WRAPPED**
 - Vendor ready
 - **FREE DECAL!**

\$41.25	VSB3065	Sham
----------------	----------------	------

NOT WRAPPED



\$0.25 FLAT BLUE-SHAM®

AMERICAN TEXTILE

- 13" x 24"
- 1250 per case
- Packed 250 per box
- **NOT WRAPPED**

\$185.25	VSB250	Sham
-----------------	---------------	------

NOT WRAPPED



\$0.50 FLAT BLUE-SHAM®

AMERICAN TEXTILE

- 22½" x 24"
- 750 per case - packed 150 per box
- **NOTE: PLEASE BE AWARE THAT THESE TOWELS ARE FLAT PACKED. FOLDED TOWEL IN IMAGE IS ONLY FOR ILLUSTRATIVE PURPOSES.**

\$227.40	VSB150	Sham
-----------------	---------------	------

NOT WRAPPED



NU-SHAM WHITE TOWEL

AMERICAN TEXTILE

- This towel is perfect for drying cars, polishing chrome, and cleaning windshields. It is designed for use with the 75 cent decal display for your car wash vending machines.
- 19" x 28"
 - 200 per case
- \$0.75 vend
 - Brings back \$150

\$46.75	VSB2055	Towels
FREE	VE0126	Decal

VENDING



VENDING TOWELS & WIPES FROM MDI



THE ORIGINAL WET TOWEL

PERFORMANCE IN A POUCH®



- Leaves windshields and mirrors sparkling clean while reducing glare
- Removes fingerprints & smoke residue
- Cleans film and road grime from headlights
- Non-streaking and self-drying
- 200 per case @ \$1.00 vend brings back \$200
- Free vending decal and free 4" x 10" - overlay for 3 column vendor available

\$54.75	VS702	200 per case
FREE	VE0124	1 Column Decal
FREE	DEDSWETT	4" x 10" Overlay

THIS PRODUCT IS NOT INTENDED FOR SALE OR DISTRIBUTION IN THE STATE OF CALIFORNIA



ATLAS TOWEL

SUPER ABSORBENT TOWELS



- High performance cloth-like towel
- Cleans windows & glass
- Interior spot cleaning
- 18" x 28"
- Wipes dry, lint-free and durable for reuse
- Exterior trim & wheels
- 150 per box

\$38.75	ATLAS	Towels
FREE	VE0130	1 Column Decal

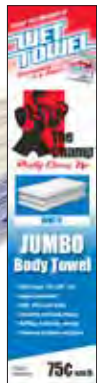

THE CHAMP® BODY TOWEL

MDI VENDING ITEMS



- Soft, thick and bulky
- Buffing, polishing & wax
- Detailing & body drying
- 200 per box
- 19" x 28"
- Available in white or blue

\$42.99	CHAMPW	White Towel	\$42.99	CHAMPBL	Blue Towel
FREE	VE0131	White Decal	FREE	VE0132	Blue Decal



FREE MDI PRODUCTS with the purchase of a vending machine! See the Vending Deals pages for more info.



SIGN UP FOR OUR WEEKLY EMAIL BLAST!

OUR WEEKLY E-BLAST FEATURES:

- Special Sale Offers
- Car Wash Hot Picks
- Featured Videos
- New Product Info
- Industry Calendar
- Sign up on the Kleen-Rite website!



RAINWIPES® TOWELS, CHAMOIS & MORE

RainWipes®



ULTIMATE MICROFIBER TOWEL

RAINWIPES

- 100 per case
- 14" x 14"
- Individually wrapped
- Cost-effective vending towel for customers and operators alike.
- Highly-effective

\$43.99 RWMF1414R



MICROFIBER PET TOWEL

RAINWIPES

- Dries 10x faster than regular rags
- Softer than traditional terry bath towels
- Washable and reusable
- Great for vending machines

\$70.39 PTW600 12" x 16" (100/case)
\$132.00 PTW610 24" x 16" (100/case)



FOLDED & WRAPPED MICROFIBER VENDING TOWEL

RAINWIPES

- Vendor ready - folded & wrapped
- Each towel measures 16" x 12"
- 100 per case
- Clean faster - easier - safer
- Eliminate swirls and scratches
- Dries 10x faster than cotton towels

\$70.39 RWMF1612 Blue
FREE RWD100 1 Col. Decal



MICROFIBER DETAILING TOWELS

RAINWIPES

- 16" x 24" each - 100 per case
- Eliminate swirls and scratches
- Dries 10x faster than cotton towels
- Choose from blue, green, or violet

\$132.00 RWMF1624 Blue
\$132.00 RWMF1624G Green
\$132.00 RWMF1624V Violet

OTHER SIZES AVAILABLE IN THE DETAILSECTION



LEATHER CHAMOIS SPONGE

RAINWIPES

- 144 chamois sponges per case
- Each chamois sponge is 4¾" x 3"
- Foam sponge encased in Leather Chamois
- Great for application/removal of waxes, touch ups and drying, and window interiors

\$99.25 RWSPONGE



DUAL SURFACE ULTIMATE MICROFIBER SPONGE

RAINWIPES

- 40 sponges per case
- These dual-surface car wash sponges are made with microfiber to protect vehicle paint from scratches. Sponge is designed with loose fringes to reach and clean narrow areas.

\$128.00 RWMF21030

See our full selection of towels in the detail section!

VENDING



GIANT INDUSTRIES TOWELS, WIPES & SCRUB PADS



GIANT T5000 VENDING-READY TOWEL KIT

GIANT

- Every package contains one each of Giant's most popular towels, in a vendable plastic bag for one convenient transaction
- Add to your vending or retail selection for great return on investment!
- 100 packages per case

EACH PACKAGE INCLUDES:

(1) Blue Aqua Towel, (1) White Supertowel, (1) Moistwipe

\$58.24	VST5000	Vend Kit
----------------	----------------	----------



MOIST WIPE WINDOW WIPE

GIANT

- 12" x 11½" - 180 per case
- Use on: glass, plastic, chrome, plated metal, and canvas
- Strong enough for large areas
- Lemon scented
- Formulated to not freeze
- Fits all drop-shelf vendors

\$42.08	VST3000	Towels
FREE	VE0103	1 Column Decal
FREE	DEDSGM	Overlay



SUPER TOWEL

GIANT

- 27" x 19" - 180 per case
- Brings back \$90 at \$0.50 vend
- Fits all drop-shelf vendors

\$30.57	VST2000	Towels
FREE	VE0103T	1 Column Decal



BLUE TOWEL

GIANT

- Packed 180 per case
- Brings back \$90 at \$0.50 vend
- Fits all drop-shelf vendors
- 18" x 27"

\$38.46	VST50BB	Towels
FREE	VE0103B	1 Column Decal

STRONGEST DISPOSABLE TOWEL ON THE MARKET



BLUE BULK TOWEL

GIANT

- Packed 360 per case
- Brings back \$90 at \$.0.25 vend
- Fits all drop-shelf vendors
- 18" x 17.5"

\$62.17	VST25BB
----------------	----------------

FREE GIANT PRODUCTS!!!

See Vendor Deals page for details on vending deals and how you can get free products from GIANT Industries!





QUICKDRY® TOWELS



MICROFIBER VEND PACKS

QUICK DRY

- Extra Large 16" x 16"
- 100 per case / individually wrapped
- Guaranteed vend in drop shelf and glass front machines
- In-store hang holes in packaging
- Extra plush / lint free / scratch free
- Free Decals and overlays available

\$79.99	QBMF1616B	Blue
\$79.99	QBMF1616G	Green
\$79.99	QBMF1616R	Red
\$79.99	QBMF1616Y	Yellow



WRAPPED BLUE MICROFIBER VENDING TOWEL

QUICK DRY

- 12" x 16", 100 per box
- Vends for \$2
- Bagged to be vendor-ready
- Lifts & traps dirt & moisture
- Details without harmful chemicals
- Absorbs 7 times its weight
- Lint free & scratch free
- **FREE Decal & Overlay Available**

\$71.23	VS182	Towels
FREE	VE0148	1 Column Decal
FREE	DEDSQD-MF	4"x 10" Overlay



XXL ALL AMERICAN WHITE TOWEL

QUICK DRY

- 200 per case
- 19½" x 31"
- **FREE Decal & Overlay Available**

\$58.75	VS208	Towels
FREE	VE0164	1 Column Decal
FREE	DEDPTXLWL	4" x 10" Overlay



ALL AMERICAN BLUE TOWEL

QUICK DRY

- 200 per case
- 19½" x 28"
- **FREE Decal & Overlay Available**

\$48.00	VS205	200 /case
FREE	VE0161	1 Column Decal
FREE	DEDPTBL	4" x 10" Overlay



ALL AMERICAN WHITE TOWEL

QUICK DRY

- 200 per case
- **FREE Decal & Overlay Available**

\$48.00	VS206	Towels
FREE	VE0162	1 Column Decal
FREE	DEDPTWL	4" x 10" Overlay



TRIPLE WASH BLUE CLOTH TOWEL

QUICK DRY

- Guaranteed to absorb faster than any cloth, paper or synthetic towel on the market. Lint free, 100% Cotton.
- 17" x 24"
- 100 per case / Wrapped
- **FREE Decal & Overlay Available**

\$65.80	VS175TWW	Wrapped Towels
\$61.10	VS175TW	Bulk Folded
FREE	VE0116	1 Column Decal
FREE	DEDSQDTW	4" x 10" Overlay



BULK WHITE VENDING TERRY TOWEL

QUICK DRY

- 15" x 18"
- 100 per case
- Brings back \$100 at \$1.00 Vend
- Durable, long lasting and reusable!
- **FREE Decal & Overlay Available**

\$67.19	VS179	Wrapped towels
\$61.88	VS180	Bulk folded towels
FREE	VE0114	1 Column Decal
FREE	DEDSQDT	4" x 10" Overlay



XXL ALL AMERICAN BLUE TOWEL

QUICK DRY

- 200 per case
- 19½" x 31"
- **FREE Decal & Overlay Available**

\$58.75	VS207	Towels
FREE	VE0163	1 Column Decal
FREE	DEDPTXLBL	4" x 10" Overlay

VENDING



QUICKDRY® TOWELS



BLUE FOLDED VENDING TOWEL

QUICK DRY



- Quick Dry Wrapped Blue Folded Vending Towels are lightweight, antimicrobial and quick-drying. Coming in bulk at wholesale prices, the Quick Dry Wrapped Blue Folded Vending Towel is perfect for all vending machines and car washes. These soft durable towels are perfect for glass cleaning and any surface you want squeaky clean!
- Bagged or unwrapped
- 17" x 22"
- 100 per case
- **FREE Decal & Overlay Available**

\$65.85	VS175W	Bagged
\$59.95	VS175	Unwrapped/Folded
FREE	VE0102	1 Column Decal
FREE	DEDSQC	4" x 10" Overlay

New!



GO PINK BREAST CANCER AWARENESS RIBBON

QUICK DRY

- 100 per case - 16" x 16"
- Microfiber, wrapped towels
- A portion of the proceeds are donated to BreastCancer.org and Hospice of Piedmont

\$86.75 **QBMF1616P**



WRAPPED WAFFLE WEAVE VENDING TOWEL

QUICK DRY

- 80 per case - 14" x 22"
- Features a unique waffle weave texture that increases surface area and quickly wicks away liquid
- Traps water and detail sprays for fast drying
- Super-soft, super-absorbent, and will not scratch paint when used properly
- **FREE Decal & Overlay Available**

\$105.00	VS174	Towels
FREE	VE0176	1 Column Decal
FREE	DEDSWA	4" x 10" Overlay



WHITE CLOTH DETAILING DIAPER

QUICK DRY

- 14" x 20"
- 100 per case
- Folded to fit all makes and models of vendors
- Individually wrapped in 5" x 7" clear 2 ml ziplock bag with hanghole.
- **FREE Decal Available**

\$127.59	VS183	Towels
FREE	VE0112	Decal



MICROFIBER PADS WITH HAND POCKET

QUICK DRY

- Circular Pads: 5"
- Rectangular Pads: 3½" x 5"
- 48 per case

\$47.49	VS172	Circular Pads
\$47.49	VS172R	Rectangular Pads

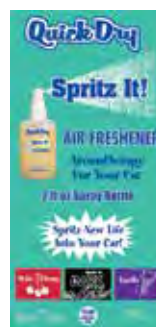

SPRITZ-IT SPRAY BOTTLE - AROMATHERAPY FOR YOUR CAR

QUICK DRY

- 2 oz. spray bottle - vendor ready
- 50 per case
- 8 pack refills available

\$63.62	VS190	Vanilla
\$63.62	VS188	Piña Colada
\$63.62	VS187	New Car
\$63.62	VS189	Strawberry
\$63.62	VS191	Wild Cherry
\$63.62	VS185	Dark Ice
FREE	VE0140	1 Column Decal
FREE	VE0147	3 Column Decal
\$63.62	VS192	48 Piece Assort. 2 oz. Bottles
FREE	VS192DT*	Free 24 Piece Display Tray

ASK FOR FREE TRAY!



QUICKDRY® CLEANERS



LOVE BUG REMOVER SPRAY QUICK DRY

- 4 oz. bottle - 24 per case
- Gentle on paint work and glass while breaking the bond of bugs left behind, leaving only a natural finish
- **FREE DECAL & OVERLAY AVAILABLE!**

\$39.19	VSLBG4	Spray
FREE	VE0171	1 Column Decal
FREE	DEDSL B	4" x 10" Overlay



CLEANZ ALL INTERIOR CLEANER WITH TOWEL QUICK DRY

- 2 oz. bottle with towel - 50 per case
- For use on: dashboard, leather, plastic, rubber, upholstery, vinyl
- **FREE DECAL & FREE OVERLAY!**

\$62.45	VS173	Spray/Towel
FREE	VE0175	1 Column Decal
FREE	DEDS C A	4" x 10" Overlay



GLASS CLEANER QUICK DRY

- 4 oz. bottle - 24 per case
- **FREE DECAL AVAILABLE!**

\$35.78	VS196	Spray
FREE	VE0168	1 Column Decal
FREE	DE DGC4L	4" x 10" Overlay



GLASS CLEANER WITH TOWEL QUICK DRY

- 2 oz. bottle with towel
- 100 per box, bagged
- **FREE DECAL & FREE OVERLAY!**

\$119.17	VS184	Spray/Towel
FREE	VE0113	1 Column Decal



WHEEL CLEANER QUICKDRY

- 4 oz. bottle • 24 per case
- **FREE DECAL & FREE OVERLAY!**

\$35.02	VS198	Spray
FREE	VE0170	1 Column Decal
FREE	DEDSWC	4" x 10" Overlay

the Quick Dry towelette®



GLASS CLEANER TOWELETTE QUICK DRY

- 3" x 5" package contains 12" x 12" spunlace towelette
- 100 per case
- **FREE DECAL & FREE OVERLAY!**

\$33.83	VSTAWC	Towelette
FREE	VE0119	1 Column Decal
FREE	DEDTAWC	4" x 10" Overlay



TIRE SHINE QUICK DRY

- 4 oz. bottle - 24 per case
- **FREE DECAL & FREE OVERLAY!**

\$38.48	VS197	24/case
FREE	VE0169	1 Column Decal
FREE	DE DTS4L	4" x 10" Overlay

INTERIOR CLEANER TOWELETTE QUICK DRY

- 12" x 12" interior cleaning towelette
- 100 per case
- Specially designed for interior automotive surfaces. For use on dash, vinyl, rubber, plastic, metal. Safe on leather!
- **FREE DECAL & FREE OVERLAY!**

\$43.01	VS169	Towelette
FREE	VE0178	1 Column Decal
FREE	DEDSIC	4" x 10" Overlay



VENDING



CHARACTER AIR FRESHENERS

PLASTICOLOR PRODUCTS ARE NOT FOR EXPORT

POPULAR CHARACTER "WIGGLER" HANGING AIR FRESHENERS

PLASTICOLOR

• 6 single packs

\$11.99



Side 1 Side 2

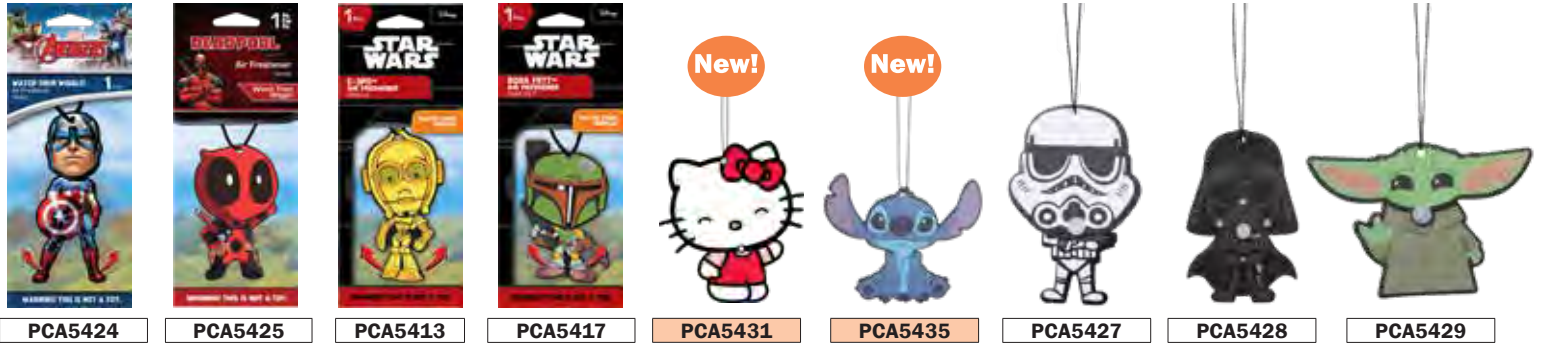

2-SIDED PAPER HANGING AIR FRESHENERS

PLASTICOLOR

• 6 single packs

\$15.30



MANDA-LORIAN 2 PLASTICOLOR • Vanilla
MANDA-LORIAN 2 PLASTICOLOR • Vanilla
DEADPOOL 2 PLASTICOLOR • Vanilla
RICK AND MORTY PLASTICOLOR • Vanilla
SCOOBY-DOO PLASTICOLOR • Vanilla

POPULAR CHARACTER HANGING AIR FRESHENERS

PLASTICOLOR

• 4 single packs

\$17.48



THE PUNISHER PLASTICOLOR • Dark Ice
DEADPOOL PLASTICOLOR • Dark Ice
JACK SKELLINGTON PLASTICOLOR • Dark Ice
BEACH DAY PLASTICOLOR • Piña Colada
PINK GLITTER PLASTICOLOR • Floral

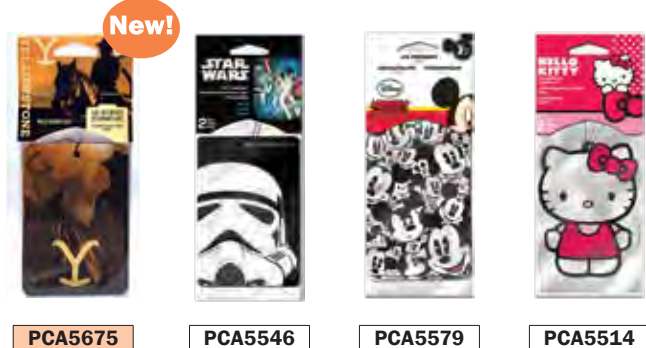

PCA5675 **PCA5546** **PCA5579** **PCA5514**

POPULAR CHARACTER HANGING AIR FRESHENERS

PLASTICOLOR

• 6 (2) packs

\$18.11

Vanilla Scented		Strawberry Scented	
PCA5546	Storm Trooper	PCA5514	Hello Kitty
PCA5579	Mickey Mouse		
Wild River Ice Scented			
PCA5675	Yellowstone		



CAR-FRESHNER PRODUCTS ON THIS PAGE MAY BE EXPORTED TO CANADA

LITTLE TREES® POUCH PACKS

CAR-FRESHNER

• When you buy 5 or more Little Trees® 72 count Pouch Packs you save!

• 5+ packs: \$43.60

\$44.10



AMERICA
POUCH PACKS

POUCHES	VS10945
OVERLAY	VS109450



BAYSIDE BREEZE
POUCH PACKS

POUCHES	VS17121
OVERLAY	VS171210



BLACK ICE
POUCH PACKS

POUCHES	VS10155
OVERLAY	VS101550



BLACKBERRY CLOVE
POUCH PACKS

POUCHES	VS17343
OVERLAY	VS173430



BUBBLE GUM
POUCH PACKS

POUCHES	VS10348
OVERLAY	VS103480



CARIBBEAN COLADA
POUCH PACKS

POUCHES	VS10324
OVERLAY	VS103240

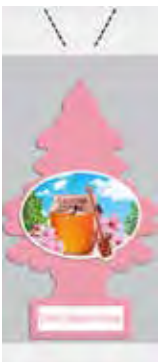

CHERRY BLOSSOM HONEY
POUCH PACK

POUCHES	VS10476
OVERLAY	VS104760



CINNAMON APPLE
POUCH PACKS

POUCHES	VS10338
OVERLAY	VS103380



COCONUT
POUCH PACKS

POUCHES	VS10317
OVERLAY	VS103170



COTTON CANDY
POUCH PACKS

POUCHES	VS10282
OVERLAY	VS102820



DRAGON FRUIT
POUCH PACKS

POUCHES	VS10397
OVERLAY	VS103970



FRESH SHAVE
POUCH PACKS

POUCHES	VS17068
OVERLAY	VS170680



GOLD
POUCH PACKS

POUCHES	VS10210
OVERLAY	VS102100



GREEN APPLE
POUCH PACKS

POUCHES	VS10316
OVERLAY	VS103160



JASMIN
POUCH PACKS

POUCHES	VS10433
OVERLAY	VS104330



LAVENDER
POUCH PACKS

POUCHES	VS10435
OVERLAY	VS104350



LEATHER
POUCH PACKS

POUCHES	VS10290
OVERLAY	VS102900



MORNING FRESH
POUCH PACKS

POUCHES	VS10228
OVERLAY	VS102280

VENDING



AIR FRESHENERS - VEND PACKS

CAR-FRESHNER PRODUCTS ON THIS PAGE MAY BE EXPORTED TO CANADA

LITTLE TREES® POUCH PACKS CAR-FRESHNER

- 72 count pouch pack
- Overlays available

\$44.10



NEW CAR SCENT POUCH PACKS

POUCHES	VS10189
OVERLAY	VS101890



NO SMOKING POUCH PACKS

POUCHES	VS17037
OVERLAY	VS170370



PEACHY PEACH POUCH PACKS

POUCHES	VS10319
OVERLAY	VS103190



PIÑA COLADA POUCH PACKS

POUCHES	VS10967
OVERLAY	VS109670



PURE STEEL™ POUCH PACKS

POUCHES	VS17152
OVERLAY	VS171520



RAINSHINE POUCH PACKS

POUCHES	VS10249
OVERLAY	VS102490



RAINFOREST MIST POUCH PACKS

POUCHES	VS10106
OVERLAY	VS101060



ROSE THORN POUCH PACKS

POUCHES	VS17308
OVERLAY	VS173080



ROYAL PINE POUCH PACKS

POUCHES	VS10101
OVERLAY	VS101010



SLICED™ POUCH PACKS

POUCHES	VS17332
OVERLAY	VS173320



STRAWBERRY POUCH PACKS

POUCHES	VS10312
OVERLAY	VS103120



SUMMER LINEN POUCH PACKS

POUCHES	VS10574
OVERLAY	VS105740



SUNSET BEACH POUCH PACKS

POUCHES	VS17177
OVERLAY	VS171770



SUPERNOVA POUCH PACKS

POUCHES	VS17303
OVERLAY	VS173030



TRUE NORTH POUCH PACKS

POUCHES	VS17146
OVERLAY	VS171460



VANILLAROMA® POUCH PACKS

POUCHES	VS10105
OVERLAY	VS101050



WATERMELON POUCH PACKS

POUCHES	VS10320
OVERLAY	VS103200



WILD CHERRY POUCH PACKS

POUCHES	VS10311
OVERLAY	VS103110

CAR-FRESHNER® PRODUCTS ARE NOT FOR EXPORT

AIR FRESHENERS - 24 CARDED SINGLES



LITTLE TREES® 24 PACKS - CARDED
CAR-FRESHNER

• 24 count carded single packs

\$15.53



AMERICA
CARDED

VS50945



BAYSIDE BREEZE
CARDED

VS57121



BLACK ICE
CARDED

VS50155



BLACKBERRY CLOVE
CARDED

VS57343



BUBBLE GUM
CARDED

VS50348



CARIBBEAN COLADA
CARDED

VS50324



CHERRY BLOSSOM HONEY
CARDED

VS50476



CINNAMON APPLE
CARDED

VS50338



COCONUT
CARDED

VS50317

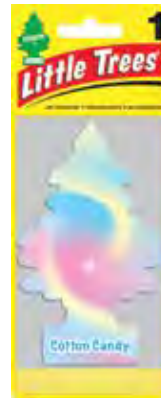

COTTON CANDY
CARDED

VS50282



DRAGON FRUIT
CARDED

VS50397



FRESH SHAVE
CARDED

VS57068



GOLD
CARDED

VS50210



GREEN APPLE
CARDED

VS50316



JASMIN
CARDED

VS50433



LAVENDER
CARDED

VS50435



LEATHER
CARDED

VS50290



MORNING FRESH
CARDED

VS50228

VENDING



AIR FRESHENERS - 24 CARDED SINGLES

CAR-FRESHNER® PRODUCTS
ARE NOT FOR EXPORT

LITTLE TREES® 24 PACKS - CARDED CAR-FRESHNER

• 24 count carded single packs

\$15.53



NEW CAR SCENT
CARDED

VS50189



NO SMOKING
CARDED

VS57037



PEACHY PEACH
CARDED

VS50319



PIÑA COLADA
CARDED

VS50967



PURE STEEL
CARDED

VS57152



RAINSHINE
CARDED

VS50249



RAINFORST MIST
CARDED

VS50106



ROSE THORN
CARDED

VS57308



ROYAL PINE
CARDED

VS50101



SLICED™
CARDED

VS57332



STRAWBERRY
CARDED

VS50312



SUMMER LINEN
CARDED

VS50574



SUNSET BEACH
CARDED

VS57177



SUPERNOVA
CARDED

VS57303



TRUE NORTH
CARDED

VS57146



VANILLAROMA
CARDED

VS50205



WATERMELON
CARDED

VS50320



WILD CHERRY
CARDED

VS50311

CAR-FRESHNER® PRODUCTS ARE NOT FOR EXPORT

AIR FRESHENERS - CARDED 2, 3 & 6 PACKS



LITTLE TREES® (2) PACKS, (3) PACKS (6) PACKS- CARDED
CAR-FRESHNER

• 12 count carded (2) packs • 8 count carded (3) packs

2 PACKS	\$15.14	3 PACKS	\$13.50	6 PACKS	\$13.09
----------------	----------------	----------------	----------------	----------------	----------------



BAYSIDE BREEZE
CARDED

VS27121

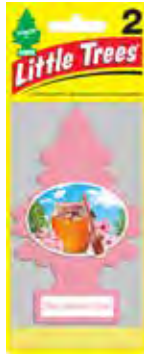

CHERRY BLOSSOM HONEY
CARDED

VS22076



COCONUT
CARDED

VS22017



PURE STEEL
CARDED

VS27152



ROYAL PINE
CARDED

VS22001



WILD CHERRY
CARDED

VS22011



DRAGON FRUIT
CARDED

VS20397	2 Pack
VS30397	3 Pack



GOLD
CARDED

VS20210	2 Pack
VS30210	3 Pack



MORNING FRESH
CARDED

VS22028	2 Pack
VS32028	3 Pack



NEW CAR SCENT
CARDED

VS22089	2 Pack
VS32089	3 Pack
VS60189	6 Pack



STRAWBERRY
CARDED

VS22012	2 Pack
VS32012	3 Pack
VS60312	6 Pack



TRUE NORTH
CARDED

VS27146	2 Pack
VS37146	3 Pack
VS67146	6 Pack



VANILLAROMA
CARDED

VS22005	2 Pack
VS32005	3 Pack
VS60105	6 Pack



BLACK ICE
CARDED

VS22055	2 Pack
VS32055	3 Pack
VS60155	6 Pack



CARIBBEAN COLADA
CARDED

VS22024	2 Pack
VS32024	3 Pack
VS60324	6 Pack

VENDING



HANGING AIR FRESHENERS

CAR-FRESHNER® PRODUCTS ARE NOT FOR EXPORT

LITTLE TREES® X-TRA STRENGTH CAR-FRESHNER

• 24 Count Carded 1-Packs

\$21.74



AMERICA
X-TRA STRENGTH

BT10645



TRUE NORTH
X-TRA STRENGTH

BT10646



CARIBBEAN COLADA
X-TRA STRENGTH

BT10624



COCONUT
X-TRA STRENGTH

BT10617



NEW CAR SCENT
X-TRA STRENGTH

BT10689



STRAWBERRY
X-TRA STRENGTH

BT10612



VANILLAROMA
X-TRA STRENGTH

BT10605

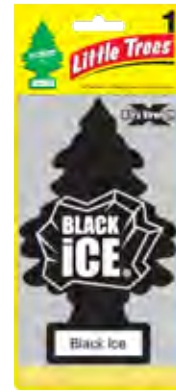

BLACK ICE
X-TRA STRENGTH

BT10155

LITTLE TREES® CLIP STRIPS CAR-FRESHNER

• 24 single pack carded Little Trees on hanging Clip Strip for easy display.

\$15.53 CF10155 Black Ice

CAR-FRESHNER® PRODUCTS ARE NOT FOR EXPORT

VENT AIR FRESHENERS



LITTLE TREES® VENT WRAP® CAR-FRESHNER

• (4) 4 packs

\$7.50



FRESH SHAVE
VENT WRAP

VS52744



WATERMELON
VENT WRAP

VS52745



BLACK ICE
VENT WRAP

VS52231



CARIBBEAN COLADA
VENT WRAP

VS52225



ODOR ELIMINATOR
VENT WRAP

VS52743



NEW CAR SCENT
VENT WRAP

VS52233



STRAWBERRY
VENT WRAP

VS52736



VANILLAROMA
VENT WRAP

VS52232



LITTLE TREES® VENT WRAP® 32 COUNT ASSORTED COUNTER DISPLAY

CAR-FRESHNER

- CONTAINS 32 ASSORTED VENT WRAP PACKS
- EACH VENT WRAP PACK CONTAINS 4 AIR FRESHENERS
- Fragrances included:
 - Black Ice
 - Caribbean Colada
 - New Car Scent

\$60.04 VS52700

VENDING



AIR FRESHENERS

CAR-FRESHNER® PRODUCTS ARE NOT FOR EXPORT

LITTLE TREES® VENT LIQUID™

• 4 Vent Liquid air fresheners

\$7.80



CARIBBEAN COLADA
VENT LIQUID

VS52625



NEW CAR SCENT
VENT LIQUID

VS52633



TRUE NORTH
VENT LIQUID

VS52641



SUMMER LINEN
VENT LIQUID

VS52635

LITTLE TREES® FIBER CANS™

• 4 cans per pack

\$6.84



BLACK ICE
FIBER CANS

VS17855



CHERRY BLAST
FIBER CANS

VS17811



CARIBBEAN COLADA
FIBER CANS

VS17824



GREEN APPLE
FIBER CANS

VS17816



NEW CAR
FIBER CANS

VS17889

LITTLE TREES® SPRAYS

• (6) 3.5 oz pump spray. 24 bottles per case.

\$11.66



BLACK ICE
PUMP SPRAYS

VS06355



CARIBBEAN COLADA
PUMP SPRAYS

VS06324



NEW CAR SCENT
PUMP SPRAYS

VS06389



STRAWBERRY
PUMP SPRAYS

VS06312



VANILLAROMA
PUMP SPRAYS

VS06305

CAR-FRESHNER® PRODUCTS ARE NOT FOR EXPORT

CAR-FRESHNER® DISPLAYS



* PHOTO MAY NOT REPRESENT ACTUAL CONTENTS. PLEASE CHECK DESCRIPTION FOR BOX CONTENTS.

LITTLE TREES® FIBER CAN™ 12 COUNT COUNTER BOX DISPLAY *

- Includes the following Fiber Can fragrances:
 (5) Black Ice (3) Cherry Blast
 (2) New Car Scent (2) Caribbean Colada

\$20.51 VS17820



LITTLE TREES® 1-PACK 96 UNIT DISPLAY CARD

- INCLUDES 24 OF EACH FRAGRANCE:
- Black Ice • Caribbean Colada
 - Vanillaroma • New Car Scent

\$62.09 VS10000-LS



LITTLE TREES® 1-PACK 48 UNIT COUNTER DISPLAY

LITTLE TREES DISPLAYS

- INCLUDES 24 OF EACH FRAGRANCE:
- Black Ice
 - New Car Scent

\$31.08 VS10000-CC

LITTLE TREES® COUNTER DISPLAYS

- Single packs. 24 packs per display unit.

\$15.53



BLACK ICE
LITTLE TREES DISPLAYS

VS80155



VANILLAROMA
LITTLE TREES DISPLAYS

VS80105



NEW CAR
LITTLE TREES DISPLAYS

VS80189



CARIBBEAN COLADA
LITTLE TREES DISPLAYS

VS80324

VENDING



FRESHFX™ AIR FRESHENERS

ARMOR ALL PRODUCTS
ARE NOT FOR EXPORT

FRESHFX™ VENT CLIP AIR FRESHENERS

ARMOR ALL

• 4 Single Packs Per Case

\$7.34

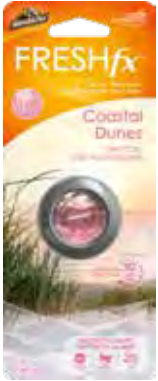

COASTAL DUNES
FRESHFX

ISLAND OASIS
FRESHFX

NEW CAR
FRESHFX

TRANQUIL SKIES
FRESHFX

**SMOKE X™ -
MIDNIGHT AIR**
FRESHFX

AR18550

AR18551

AR18549

AR18547

AR18951

HANDSTANDS® AIR FRESHENERS

HANDSTANDS PRODUCTS
ARE NOT FOR EXPORT



**DRIVEN™ 3D AIR
FRESHENERS**
HANDSTANDS

• (4) 2 Packs

\$8.69 HSAF78207

DRIVEN™ 3D HANGING FRESHENERS
HANDSTANDS

• 4 Packs

\$8.69 HSAF78107 Ammo
HSAF76107 Dog Tags

DRIVEN™ GEL AIR FRESHENER
HANDSTANDS

• 3 oz. - 4 Pack

\$8.96 HSAF74103 Titanium Rain
HSAF74107 Black Out

CAP TURNS TO ADJUST FRAGRANCE STRENGTH



AXE PRODUCTS ARE NOT FOR EXPORT

AXE AIR FRESHENERS



HANGING GEL AIR FRESHENERS

AXE

- 2 gels per pack - 6 packs per case

\$17.44	HSAF13700	Dark Temptation
	HSAF13600	Black
	HSAF13800	Phoenix
	HSAF13500	Apollo



MINI VENT CLIP AIR FRESHENERS

AXE

- 1 or 2 mini vent clips per pack - 6 packs per case

6 PER CASE SINGLE		6 PER CASE 2-PACKS	
HSAF14100	Dark Temptation	HSAF23000	Dark Temptation
HSAF14000	Black	HSAF22900	Black
HSAF14200	Phoenix	HSAF23200	Phoenix
HSAF13900	Apollo	HSAF22800	Apollo
HSAF34500	Essence	HSAF23100	Essence
\$17.12		\$30.80	



GEL CAN AIR FRESHENERS

AXE

- 4.4 oz gel cans

6 SINGLES PER CASE		4 PER TRAY	
HSAF13300	Dark Temptation	HSAF03100	Dark Temptation
HSAF13200	Black	HSAF02800	Black
HSAF13400	Phoenix	HSAF03200	Phoenix
HSAF13100	Apollo	HSAF03000	Apollo
\$17.12		HSAF02900	Essence
		\$11.20	



FIBERBOARD CAN

AXE

- 4.4 oz gel cans | 4 per case

HSAF38350	Apollo
HSAF38351	Black
\$13.00	

HANDSTANDS® REFRESH YOUR CAR®

HANDSTANDS PRODUCTS ARE NOT FOR EXPORT



REFRESH YOUR CAR® MINI OIL DIFFUSERS

HANDSTANDS

- 2 per pack - 1oz. each

4 PACKS PER CASE		
\$8.05	HSAF09138	Fresh Linen
\$8.05	HSAF09136	Hawaiian Sunrise
\$8.05	HSAF09135	New Car
\$8.05	HSAF09134	Very Cherry
\$7.55	HSAF38374	Pine & Moss/Fresh Clover
\$7.55	HSAF38372	Lavender
6 PACKS PER CASE		
\$8.05	HSAF40000	Crisp Laundry



REFRESH YOUR CAR® VENT STICKS

HANDSTANDS

- 6 vent sticks per pack - 6 packs per case

SINGLE SCENT		
\$12.08	HSAF39845	Fresh Linen
\$12.08	HSAF39846	Hawaiian Sunrise
DUAL SCENT		
\$12.08	HSAF39844	New Car/Cool Breeze
\$12.08	HSAF39843	Lightning Bolt/Ice Storm



REFRESH YOUR CAR® MINI DUAL OIL DIFFUSERS

HANDSTANDS

- 2 per pack - 4 per case
- Case count varies, see charts below
- Attaches to vent

CASE OF 4		
\$8.05	HSAF09870	Summer Breeze/ Alpine Meadow
\$8.05	HSAF09872	Fresh Strawberry/ Cool Lemonade
\$8.05	HSAF09875	New Car/Cool Breeze
\$8.05	HSAF09877	Lightning Bolt/Ice Storm
\$8.05	HSAF39900	Pine & Moss
\$8.05	HSAF42600	Strawberry/Fresh Linen



REFRESH YOUR CAR® VENT AIR FRESHENERS

HANDSTANDS

- 4 vent sticks per pack - 6 packs per case

\$14.25	HSAF38375	Crisp Laundry
\$13.95	HSAF38376	Hawaiian Sunrise
\$14.25	HSAF38377	New Car



REFRESH YOUR CAR® VENT STICKS

HANDSTANDS

- 6 vent sticks per pack - 6 packs per case

\$14.72	HSAF40100	Cool Breeze
\$14.72	HSAF42300	Refined Nights



REFRESH YOUR CAR® DUAL SCENT VENT STICKS

HANDSTANDS

- 4 vent sticks per pack - 6 packs per case

\$8.56	HSAF09593	Fresh Strawberry/Cool Lemonade
\$8.56	HSAF09578	New Car/Cool Breeze
\$12.08	HSAF42100	Sweet Berry/Fresh Linen



REFRESH YOUR CAR® SINGLE SCENT VENT STICKS

HANDSTANDS

- 6 vent sticks per pack - 6 packs per case

\$12.08	HSAF40400	Aged Cedar
\$12.08	HSAF40200	Pine & Moss
\$11.32	HSAF38369	Lavender
\$9.00	HSAF38371	Pine & Moss/ Fresh Clover



REFRESH YOUR CAR® SINGLE SCENT VENT STICKS

HANDSTANDS

- 4 vent sticks per pack • 6 packs per case

\$8.56	HSAF09588	New Car
\$8.56	HSAF09597	Very Cherry
\$8.56	HSAF09539	Mixed Berries
\$8.56	HSAF09545	Pacific Rain
\$8.56	HSAF09544	Hawaiian Sunrise

HANDSTANDS PRODUCTS
ARE NOT FOR EXPORT

HANDSTANDS® REFRESH YOUR CAR®



REFRESH YOUR CAR® DISCRETE RING HANDSTANDS

- 1 diffuser per pack - 6 packs per case

\$12.90	HSAF38322	Fresh Linen
\$12.90	HSAF38321	Lightning Bolt
\$12.90	HSAF38320	Very Cherry



REFRESH YOUR CAR® SINGLE/DUAL OIL DIFFUSERS HANDSTANDS

- 1 diffuser per pack - 4 packs per case
- Attaches to vent - adjustable scent control lever

Dual Oil		
\$7.57	HSAF09020	Summer Breeze/ Alpine Meadow
\$7.57	HSAF09024	New Car/Cool Breeze
\$7.57	HSAF09022	Fresh Strawberry/ Cool Lemonade
Single Oil		
\$8.39	HSAF09013	Fresh Linen

New!



REFRESH YOUR CAR® MINI OIL DIFFUSER HANDSTANDS

- 2 diffusers per pack - 6 packs per case

\$12.08	HSAF39853	Fresh Linen
\$12.08	HSAF39856	Hawaiian Sunrise

New!



REFRESH YOUR CAR® MINI DUAL OIL DIFFUSER HANDSTANDS

- 2 diffusers per pack - 6 packs per case

\$12.08	HSAF39852	New Car/Cool Breeze
\$12.08	HSAF39850	Lightning Bolt/Ice Storm



REFRESH YOUR CAR® DUAL SCENT GEL HANDSTANDS

- 5 oz. dual scent container - 4 containers per case

\$8.21	HSAF09902	Midnight Black/Ice Storm
\$8.21	HSAF09101	New Car Scent/Cool Breeze
\$8.21	HSAF09102	Fresh Strawberry/Cool Lemonade



REFRESH YOUR CAR® GEL HANDSTANDS

- 4.5 oz. gel container - 4 gel containers per case

\$6.99	HSAF09941	New Car Scent
\$6.99	HSAF09967	Very Cherry
\$6.99	HSAF09966	Summer Breeze
\$6.99	HSAF09964	Hawaiian Sunrise
\$8.21	HSAF09921	Fresh Linen

New!



REFRESH YOUR CAR® SPRAY HANDSTANDS

- 8 fl oz. - 4 per pack

\$6.35	HSAF39860	Lightning Bolt/Ice Storm
--------	-----------	--------------------------

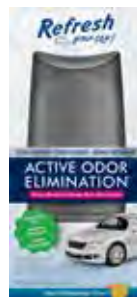

ACTIVE ODOR ELIMINATION™ REFRESH YOUR CAR

- 3 oz. foggers - 4 per case

\$16.30	HSAF02050	New Car
\$16.30	HSAF08202	Citrus



BLESSED™ METAL CROSS HANDSTANDS FRESHENERS

- 1 cross per pack - 4 packs per case
- Moonlit Grove Scent

\$7.79	HSAF03102
--------	-----------

VENDING



CALIFORNIA SCENTS® CAN AIR FRESHENERS

HANDSTANDS PRODUCTS ARE NOT FOR EXPORT



XTREME CAN AIR FRESHENERS CALIFORNIA SCENTS

\$9.00	CS8346	Coronado Cherry
\$9.00	CS8347	Ice
\$9.00	CS8349	Newport New Car



SPILLPROOF CAN AIR FRESHENERS CALIFORNIA SCENTS

12 PACKS		
\$18.75	CS1207	Coronado Cherry
\$19.63	CS12205	Ice
\$19.63	CS1212	Shasta Strawberry
\$19.63	CS1208	Jasmine
18 PACKS		
\$29.47	CS1807	Coronado Cherry
\$29.47	CS1829	Golden State Delight
\$18.75	CS1222	Newport New Car



HANGING VIAL CALIFORNIA SCENTS

• 1 per pack • 4 per case

\$10.60	CS8365	Coronado Cherry
\$10.60	CS8366	Ice
\$10.60	CS8367	Monterey Vanilla
\$10.60	CS8368	Newport New Car



3D PAPER 1PK CALIFORNIA SCENTS

• 6 per case

\$16.50	CS8319	Breezy Pine
\$16.50	CS8317	Vanilla Escape
\$16.50	CS8318	Zesty Lemongrass



SCENTED ISLAND LEI FLOWERS CALIFORNIA SCENTS

• 1 per pack • 4 per case

\$10.60	CS8309	California Clean
\$10.60	CS8307	Coronado Cherry
\$10.60	CS8308	Tropical Colada



ORANGE SQUEEZE CALIFORNIA SCENTS

• 4 per case • 3.5 oz.

\$13.12	OS024
---------	-------



CORONADO CHERRY FOGGER CALIFORNIA SCENTS

• 4 per case • 3 oz.

\$22.99	CS0071
---------	--------



CORONADO CHERRY AEROSOL SPRAY CALIFORNIA SCENTS

• 4 per case • 3.5 oz.

\$8.00	CS41407
--------	---------



SUMMERY SANDAL SCENT HANGER CALIFORNIA SCENTS

• 1 per pack • 4 per case

\$8.60	CS8305	California Clean
\$8.60	CS8299	Ice
\$8.60	CS8303	Tropical Colada



SCENT BLOC™ CALIFORNIA SCENTS

• 6 single packs

\$7.13	CSPB607	Coronado Cherry
\$7.13	CSPB6205	Ice



**HANDSTANDS PRODUCTS
ARE NOT FOR EXPORT**

CALIFORNIA SCENTS® AIR FRESHNERS



New!

SUN SPINNER AIR FRESHENER CALIFORNIA SCENTS

• 6 vent sticks per pack • 6 packs per case

PRICE	PART #	FRAGRANCE
\$15.07	CS39873	New Car
\$15.07	CS39871	Coronado Cherry
\$15.07	CS39872	Tropical Colada



COUNTERTOP CAN DISPLAY CALIFORNIA SCENTS

- 18 spill-proof cans
- Features an assortment of colorful fresh fragrances
- Fragrance cans are eco-friendly and contain a biodegradable scent pad

\$29.47 CS1801CT



VENT STICKS CALIFORNIA SCENTS

• 6 vent sticks per pack • 6 packs per case

PRICE	PART #	FRAGRANCE
\$14.24	CS9100	Newport New Car
\$14.24	CS8900	Coronado Cherry
\$14.24	CS9000	Ice



CAR SCENTS™ ASSORTED DISPLAY CALIFORNIA SCENTS

- Display fits 12 Car Scents air fresheners (included)
- Fragrances: Laguna Breeze, La Jolla Lemon, Desert Jasmine, Monterey Vanilla, Newport New Car, Concord Cranberry, Coronado Cherry

\$19.63 CCS12CT



MINI DIFFUSERS CALIFORNIA SCENTS

• 2 mini diffusers per pack • 6 packs per case

PRICE	PART #	FRAGRANCE
\$9.49	CS8800	Newport New Car
\$9.49	CS8600	Coronado Cherry
\$9.49	CS8700	Ice



HANGING PALMS CALIFORNIA SCENTS

• 4 palms per pack • 6 packs per case

PRICE	PART #	FRAGRANCE
\$12.88	CS9700	Catalina Jasmine
\$12.88	CS2400	Sacramento Apple
\$12.88	CS9800	Santa Cruz Beach
\$12.88	CS9600	Beverly Hills Bergamot



<https://californiascents.com/products/novelty-sun-spinner-vent-clip/>



HANGING & SHEET AIR FRESHENERS

"OUR HEROES" FRESHENERS JENRAY AIR FRESHENERS



• 12 per case • Ocean Fresh Scent

\$6.60



GO MARINES
JENRAY

JPGM1

FIREMAN
JENRAY

JPOURF

POLICE
JENRAY

JPOURP

NATIONALITY AIR FRESHENERS JENRAY AIR FRESHENERS



• 12 per case • Ocean Fresh Scent

\$6.60



PUERTO RICAN
JENRAY

JPPTBP

MEXICAN
JENRAY

JPPTBM

GUATEMALAN
JENRAY

JPPTBG

AMERICAN ASSORTMENT
JENRAY

JPAFA

JENRAY™ MOONSHINE AIR FRESHENERS JENRAY AIR FRESHENERS



• 12 per case

\$7.05



BLACK LIGHTNING (ICE)
JENRAY

JPMS74

CHERRY
JENRAY

JPMS2

DOA (CLEAN & FRESH)
JENRAY

JPMS75

LIQUID VICTORY (SWEET APPLE)
JENRAY

JPMS29

NEW CAR
JENRAY

JPMS22

PINK LEMONADE
JENRAY

JPMS91

WHITE LIGHTNING (VANILLA)
JENRAY

JPMS23

ZOMBIE JUICE (COOL WAVE)
JENRAY

JPMS92



12 PACK MO' MONEY
JENRAY

• 12 Pack

\$6.45 JPMON1



**SMALL SCENT SAK 24
PIECE ASSORTED DISPLAY**
JENRAY

• Includes 3 of each of various scents which may include: cherry, vanilla, new car, fresh linen, wild berry, cactus flower, cinnamon, baby powder, lavender, green apple, ice

\$33.00 JPSSAK24



JENRAY™ SMELLY SHIRTS
JENRAY

• 72 Pouch Packs • FREE DECAL

\$20.70

JPSTS2 Cherry

JPSTSL 1 Col. Decal



NO SMOKING
JENRAY

• 12 Per Case • Ocean Fresh Scent

\$5.55 JPNSS1



HANGING & SHEET AIR FRESHENERS

NOVELTY

JENRAY AIR FRESHENERS

- 12 per case
- Ocean Fresh Scent



HAVE A BLESSED DAY
JENRAY

\$6.60 JPHBD1



RAINBOW
JENRAY

\$5.85 JPRB1



TASMANIAN DEVIL
JENRAY

\$8.55 JPTAZ1

THE ACE

JENRAY

- 12 Pack Carded

\$6.45



NEW CAR
JENRAY

JPPC22



BLACK DIAMOND
JENRAY

JPPC74



CHERRY
JENRAY

JPPC2



VANILLA CITRON
JENRAY

JPPC23



STRAWBERRY
JENRAY

JPPC7

SMILE AIR FRESHNERS

JENRAY

- 12 Pack Carded
- Clean & Fresh Scent

\$6.45



MUSTACHE
JENRAY

JPSE1



BEARD
JENRAY

JPSE2



SUNGLASSES
JENRAY

JPSE3

ATTITUDE AIR FRESHENERS

JENRAY

- 12 Pack Carded

\$6.90



"TOMMY"
JENRAY

JPSAT17



CK1
JENRAY

JPSAT47



POLO
JENRAY

JPSAT36



SUPER POWER SHEETS

JENRAY AIR FRESHENERS

- 6 Pack Carded

\$6.83

JPSSHT2	Cherry	JPSSHT28	Ocean Fresh
JPSSHT7	Strawberry	JPSSHT50	Cool Water
JPSSHT22	New Car	JPSSHT74	Black Diamond
JPSSHT23	Vanilla	JPSSHT75	Fresh Linen

VENDING



HANGING AIR FRESHENERS - CARDED & POUCH PACKS

BOMB AIR FRESHENERS™ & MORE CUSTOM FRESHENERS

• 72 pouch packs

\$33.93



BERRY
BOMB AIR FRESHENERS

AFPP110



CHERRY
BOMB AIR FRESHENERS

AFPP101



CINNA
BOMB AIR FRESHENERS

AFPP103



CITRUS
BOMB AIR FRESHENERS

AFPP104



COLADA
BOMB AIR FRESHENERS

AFPP109



ICE
BOMB AIR FRESHENERS

AFPP113



JASMINE
BOMB AIR FRESHENERS

AFPP105



NILLA
BOMB AIR FRESHENERS

AFPP102



NUCAR
BOMB AIR FRESHENERS

AFPP107



PINE
BOMB AIR FRESHENERS

AFPP106



SWEET PEA
CUSTOM FRESHENERS

AFPP115

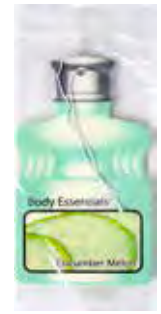

CUCUMBER
CUSTOM FRESHENERS

AFPP117

24 PACK CARDED AIR FRESHENERS CUSTOM FRESHENERS

• 24 Packs - Carded

\$12.60



CHERRY

AF24C1P101

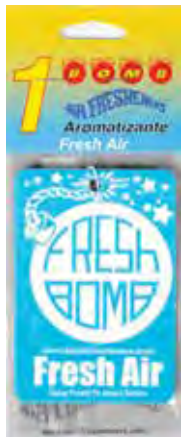

FRESH AIR

AF24C1P137



ICE

AF24C1P113



NUCAR

AF24C1P107



NILLA

AF24C1P102



BOMB AIR FRESHENERS™ CUSTOM FRESHENERS

• 1000 per case

\$354.97

AF1K101	Cherry Bomb
AF1K102	Nilla Bomb
AF1K103	Cinna Bomb
AF1K104	Citrus Bomb
AF1K105	Jasmine Bomb
AF1K106	Pine Bomb
AF1K107	NuCar Bomb
AF1K109	Colada Bomb
AF1K110	Berry Bomb
AF1K113	Ice Bomb
AF1K114	Powder Bomb
AF1K117	Cucumber Melon
AF1K137	Fresh Bomb
AF1K108	Lemon Bomb

AIR FRESHENERS / SANITIZERS & ODOR ELIMINATORS

VENT FRESH OIL AIR FRESHENERS SCENTS AIR FRESHENERS

- 4 single packs per box
- Adjustable fragrance

Scents

\$7.51



WILDBERRIES
SCENTS VENT FRESH

MDVNTFR49



ISLAND COLADA
SCENTS VENT FRESH

MDVNTFR44



OUTDOOR BREEZE
SCENTS VENT FRESH

MDVNTFR28



NEW CAR SCENT
SCENTS VENT FRESH

MDVNTFR22

ORIGINAL OZIUM AIR SANITIZER



- 8 oz. air sanitizer - 6 per box
- Sanitizes and cleans air, temporarily reducing airborne bacteria and fighting its spread
- Doesn't just mask odors, it obliterates them by attacking and reducing odor-causing bacteria
- Eliminates odors from smoke and other unpleasant everyday smells leaving the air clean and odor-free.
- Just a short spray cleans the air with a light burst of fragrance that disappears with the odor; there's no overwhelming scent or lingering smells.
- Trusted for over 50 years, OZIUM® was originally developed to combat airborne bacteria in hospitals and is clinically proven to sanitize and freshen the air.



\$39.15 MDOZ5539

OZIUM® AIR SANITIZER OZIUM



- 3.5 oz air sanitizer - 4 per box

\$23.61

OZIUM® AIR SANITIZER OZIUM



- 0.8 oz. air sanitizer - 6 per box

\$18.07



OUTDOOR ESSENCE
OZIUM

MDOZM31



VANILLA
OZIUM®

MDOZM23



ORIGINAL
OZIUM®

MDOZM1



VANILLA
OZIUM

MDOZ23



CITRUS
OZIUM

MDOZ62



OUTDOOR ESSENCE
OZIUM

MDOZ31



NEW CAR
OZIUM

MDOZ22



ORIGINAL
OZIUM

MDOZ1



New!

OZIUM® GEL OZIUM



- 4.5 oz gel - 4 per case
- Perfect for home, office or car use
- Great choice to offer customers at your car wash or detailing shop
- Eliminates smoke and odors effectively
- The simple, compact design discreetly fits anywhere, and the adjustable lid allows for fragrance level control

PRICE	PART #	FRAGRANCE
\$10.68	MDOZ4281	Original
\$10.68	MDOZ7083	Carbon Black
\$10.68	MDOZ7042	That New Car Smell®



FEBREZE® AIR FRESHENERS & FABRIC SPRAYS

FEBREZE® CAR™ VENT CLIPS

FEBREZE

• 8 single packs

\$29.81



AUTO FRESH LAUNDRY
FEBREZE CAR

PGA1969



AUTO UNSTOPPABLE FRESH
FEBREZE CAR

PGA7713



OLD SPICE
FEBREZE CAR

PGA8816



FIJI OLD SPICE
FEBREZE CAR

PGA4721



OLD SPICE SWAGGER
FEBREZE CAR

PGA4763



PLATINUM ICE
FEBREZE CAR

PGA8813



GAIN ORIGINAL SCENT
FEBREZE CAR

PGA5107



GAIN ISLAND FRESH
FEBREZE CAR

PGA4722



MIDNIGHT STORM
FEBREZE CAR

PGA5112



MIDNIGHT STORM
FEBREZE CAR

PGA1116



LINEN AND SKY
FEBREZE CAR

PGA1113

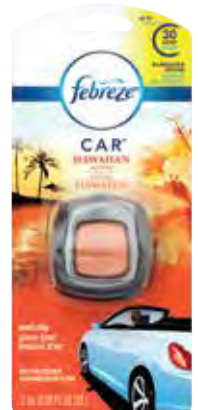

HAWAIIAN ALOHA
FEBREZE CAR

PGA1114



FABRIC REFRESHER CLEAN AUTO
FEBREZE FABRIC SPRAYS

- Replace tough odors and funky car smells with the fresh, just-car-washed scent of Fabric Refresher Clean
- Original scent spray, in 16.9 oz trigger spray bottles
- Perfect resale opportunity at your wash or retail location
- Case of 6 bottles

\$22.36

PGA0717

ORIGINAL SCENT





ARM & HAMMER AIR FRESHENERS™

5 PIECE DISPLAY VENT CLIPS

ARM & HAMMER

• 2 displays • 5 vent clips per display

\$20.33



CLEAN BURST VENT CLIP DISPLAYS

AH8200D

SPRINGTIME VENT CLIP DISPLAYS

AH8202D

NEW CAR VENT CLIP DISPLAYS

AH8204D

5 PIECE DISPLAY UNDER THE SEAT

ARM & HAMMER

• 2 displays • 5 packs of 3 fresheners per display

\$24.11



CLEAN BURST UNDER THE SEAT DISPLAY

AH8500D

SPRINGTIME UNDER THE SEAT DISPLAY

AH8502D

NEW CAR UNDER THE SEAT DISPLAY

AH8504D

VENT CLIPS

ARM & HAMMER

• 12 per case

\$25.46



CLEAN BURST VENT CLIPS

AH8200

SPRINGTIME VENT CLIPS

AH8202

NEW CAR VENT CLIPS

AH8204

PUMP SPRAYS

ARM & HAMMER

• 12 per case

\$28.93



CLEAN BURST PUMP SPRAYS

AH8400

UNDER THE SEAT AIR FRESHENERS

ARM & HAMMER

• (12) 3 packs per case

\$32.25



CLEAN BURST UNDER THE SEAT

AH8500

SPRINGTIME UNDER THE SEAT

AH8502

GEL CANISTERS

ARM & HAMMER

• 12 per case

\$24.60



CLEAN BURST GEL CANISTERS

AH8300

NEW CAR GEL CANISTERS

AH8304

VENDING



ARM & HAMMER AIR FRESHENERS™

VENT CLIPS ARM & HAMMER

• 4 packs

\$9.46



TAHITI ORCHID
VENT CLIPS

AH8800



WATER LILY
VENT CLIPS

AH8802



SPRINGTIME
VENT CLIPS

AH8804



MORNING MIST
VENT CLIPS

AH8806



TROPICAL
VENT CLIPS

AH8266



CLEAN BURST
VENT CLIPS

AH8241



MIDNIGHT
VENT CLIPS

AH8221



SUNRISE
VENT CLIPS

AH8231



KR STOCK Inventory Management APP

- Keep Your Inventory Accurate!
- Multi-Site Management!
- Easy Ordering!



CITRUS MAGIC®

SOLID ODOR ABSORBING AIR FRESHENERS

CITRUS MAGIC

- 6 per pack
- With Tray

\$20.96



NEW CAR FRESH

CITRUS MAGIC

- 8 oz.

CM2426



REFRESHING LAVENDER

CITRUS MAGIC

- 8 oz.

CM2406



TROPICAL CITRUS

CITRUS MAGIC

- 8 oz.

CM1533



SEA BREEZE LINEN

CITRUS MAGIC

- 8 oz.

CM1714



WILD CHERRY

CITRUS MAGIC

- 7 oz.

CM2837



ODOR ELIMINATOR

HERO CLEAN

- 17 oz. - 6 per case

\$27.04 **CM0402**



NATURAL ALL PURPOSE CLEANER

CITRUS MAGIC

- 22 oz. - 12 per case

\$37.33 **CM2799**



GREASE MONKEY HEAVY DUTY HAND WIPES

GREASE MONKEY

- 25 wipes/canister - 6 canisters/pack

\$19.27 **CM7653**



CITRUS MAGIC - CARDED

CITRUS MAGIC

- 1.36 oz. - 12 per case

\$37.77 **CM1053**



SOLID AIR FRESHENER

HERO CLEAN

- 8 oz. - 6 per pack

\$20.96 **CM3002**



FLOOR STAND DISPLAY

CITRUS MAGIC DISPLAYS

- 44 sprays per display

\$194.57 **CM2765**



YANKEE CANDLE® AIR FRESHENERS



CAR JAR® ULTIMATE SINGLES

YANKEE CANDLE

• 6 per box

\$20.42

YC17368	Bayside Cedar	YC51496	Catching Rays
YC20934	Bahama Breeze™ TOP SELLER	YC36293	Coconut Beach
YC20878	Clean Cotton™	YC20885	Macintosh
YC36293	Coconut Beach	YC20877	MidSummer's Night® TOP SELLER
YC20908	Home Sweet Home®	YC17367	Ocean Air
YC17365	Iced Berry Lemonade	YC38122	Pink Sands™
YC20883	Leather	YC20904	Sage & Citrus
YC20907	Lemon Lavender	YC20890	Sun and Sand
		YC20923	Vanilla Cupcake
		YC17366	Wild Orchid



CAR JAR® PAPER HANGING AIR FRESHENERS

YANKEE CANDLE

• Individually packaged, 10 per box

\$16.90

YC07567	Bahama Breeze™ TOP SELLER	YC20389	Macintosh
YC20639	Clean Cotton™ TOP SELLER	YC20366	MidSummer's Night®
YC33263	Iced Berry Lemonade	YC33287	Ocean Air
		YC07566	Pink Sands™



ROOM SPRAY

YANKEE CANDLE

• 6 per box

\$27.14

YC84674	Home Sweet Home
YC23131	Sage & Citrus
YC23122	Clean Cotton



CAR VENT STICKS

YANKEE CANDLE

• (6) 4 Pack
• Resealable container

\$20.42

YC07036	Bahama Breeze TOP SELLER
YC94390	MidSummer's Night® TOP SELLER
YC07035	Pink Sands™



CAR JAR 3-PACKS

YANKEE CANDLE

• (4) 3 per pack

\$13.59

YC37093	Black Coconut, Bahama Breeze, Turquoise Sky
YC52468	Pink Sands™

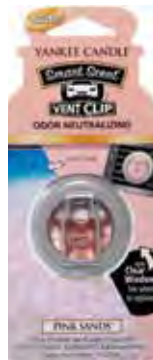

SMART SCENT™ VENT CLIPS

YANKEE CANDLE

• (4) 1 Pack
• Clear window lets you know when it's time to replace
• Fragrance is released as air flows from vehicles' air vents.
• Works best with temperatures of 70°F and above.

\$13.59

YC04389	Bahama Breeze™ TOP SELLER	YC33273	Iced Berry Lemonade
YC04391	Clean Cotton™ TOP SELLER	YC04388	Pink Sands™
YC04392	Macintosh TOP SELLER	YC12848	Sage & Citrus
YC04390	MidSummer's Night® TOP SELLER	YC04393	Sun & Sand®
YC36528	Coconut Beach		

KEYSTONE SCENT & DAKOTA PRODUCTS AIR FRESHENERS

SCENT STONE® AIR FRESHENERS

KEYSTONE SCENT



• 12 scented stone packs

\$17.93

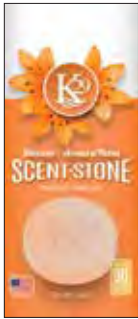

BLOSSOM
SCENT STONE

KSC16001



CHERRY
SCENT STONE

KSC16003



CINNAMON
SCENT STONE

KSC16004



COCONUT
SCENT STONE

KSC16005



COOL ICE
SCENT STONE

KSC16085



NEW CAR
SCENT STONE

KSC16002



STRAWBERRY
SCENT STONE

KSC16012



VANILLA
SCENT STONE

KSC16013



WILDBERRY
SCENT STONE

KSC16018

VENT STONE® AIR FRESHENERS

KEYSTONE SCENT



• 10 scented vent stones

\$15.24



BLOSSOM
SCENT STONE

ST24001



NEW CAR
SCENT STONE

ST24012



CHERRY
SCENT STONE

ST24003



COOL ICE
SCENT STONE

ST24085



STERLING TEAL TIN SCENTS 18 COUNT COUNTERTOP DISPLAY AIR FRESHENERS



• Tin Scents are organic, long-lasting and highly effective air fresheners. Slider tin allows for complete scent control of desired strength and it lasts for weeks! The tin is reusable for storage (clean thoroughly).

• ASSORTED MIX COUNTER DISPLAY INCLUDES:

- 3 Cherry
- 2 Coconut
- 3 Cool Ice
- 1 Strawberry
- 2 Wildberry
- 3 Blossom
- 1 New Car
- 3 Pacific Breeze

\$27.21

ST30518



LASTS UP TO 90 DAYS!



VENTSATIONS® SCENTED VENT CLIPS

DAKOTA PRODUCTS, INC.



• 72 packs, 2 clips per pack

\$29.95

DPVP2CC	Clean Car
DPVP2PB	Pacific Breeze
DPVP2BC	Black Cherry
DPVP2NT	Nautical

DPVP2SB	Strawberry
DPVP2FL	Fine Leather
DPVP2VN	Vanilla
DPV1VD	1 Col. Decal

FREE DECAL!

DECALS & OVERLAYS



BOMB FRESHENERS

DECALS & OVERLAYS

- 3-column electrical & mechanical **FREE**
- | | | | |
|-----------------|------------|-----------------|------------|
| AF3CM100 | Mechanical | AF3CE100 | Electrical |
|-----------------|------------|-----------------|------------|

BOMB FRESHENERS OVERLAYS

DECALS & OVERLAYS

- For Bomb Fresheners scents **FREE**

AF0110	Berry Bomb	AF0102	Nilla Bomb
AF0101	Cherry Bomb	AF0107	NuCar Bomb
AF0103	Cinna Bomb	AF0106	Pine Bomb
AF0104	Citrus Bomb	AF0115	Sweet Pea
AF0109	Colada Bomb	AF0117	Cucumber Melon
AF0113	Ice Bomb		

VE0156



VE0157



DEDS156



CAR JAR FROM YANKEE CANDLE

YANKEE CANDLE DECALS & OVERLAYS

- Various sizes **FREE**

VE0156	Single-Column
VE0157	3-Column
DEDS156	Overlay, Specify Fragrance

VE0139



VE0118 SIDE



VE0118 FRONT



LITTLE TREES® DECALS

DECALS & OVERLAYS

FREE	VE0139	Single-Column - Front Decal
	VE0118	5-Column Vendor Set - (1) Front & (2) Side Decals

LITTLE TREES®

DECALS & OVERLAYS

- Individual scent overlays **\$0.25**

VS109450	America	VS102280	Morning Fresh
VS171210	Bayside Breeze	VS101890	New Car Scent
VS101550	Black Ice	VS170370	No Smoking
VS173430	Blackberry Clove	VS103190	Peachy Peach
VS103480	Bubble Gum	VS109670	Pina Colada
VS103240	Caribbean Colada	VS171520	Pure Steel
VS173570	Celebrate	VS102490	Rainshine
VS104760	Cherry Blossom Honey	VS101060	Rainforest Mist
VS103380	Cinnamon Apple	VS173080	Rose Thorn
VS103170	Coconut	VS101010	Royal Pine
VS102820	Cotton Candy	VS173320	Sliced
VS103970	Dragon Fruit	VS103120	Strawberry
VS170680	Fresh Shave	VS105740	Summer Linen
VS102100	Gold	VS171770	Sunset Beach
VS103160	Green Apple	VS173030	Supernova
VS104330	Jasmin	VS171460	True North
VS104350	Lavender	VS101050	Vanillaroma
VS102900	Leather	VS103200	Watermelon
		VS103110	Wild Cherry
		VS174250	Wild Hemp

VE0147



DEDS1



SPRITZ IT! DECALS & OVERLAYS

QUICK DRY DECALS & OVERLAYS

- Various sizes **FREE**

VE0147	3-Column
DEDS1	Overlay
VE0145	Vanilla
VE0142	New Car
VE0137	Dark Ice
VE0144	Strawberry
VE0146	Wild Cherry
VE0143	Pina Colada

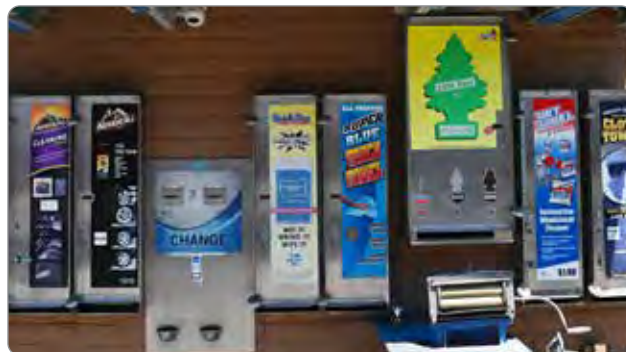

DECALS

AIR FRESHENER DECALS FOR SINGLE-COLUMN VENDORS

BOMB AIR FRESHENER DECALS

• Decals are peel and stick

FREE



CHERRY

AFSCD101



NILLA

AFSCD102



CINNA

AFSCD103



CITRUS

AFSCD104



JASMINE

AFSCD105



PINE

AFSCD106



NUCAR

AFSCD107



COLADA

AFSCD109



**STRAWBERRY
BOMB AIR
FRESHENER DECALS**

AFSCD110



**ICE
BOMB AIR
FRESHENER DECALS**

AFSCD113



**SWEET PEA
BOMB AIR
FRESHENER DECALS**

AFSCD115



**CUCUMBER
MELON
BOMB AIR
FRESHENER DECALS**

AFSCD117



**VENTSATIONS
FRESHENER DECALS**

DPV1VD



**SMELLY
SHIRTS
FRESHENER DECALS**

JPSTSL



**SPRITZ IT!
FRESHENER DECALS**

VE0140

DECALS

TOWEL AND CLEANER DECALS FOR SINGLE-COLUMN VENDORS

DECALS

• Decals are peel and stick

FREE



WET TOWEL
DECALS

VE0124



ATLAS TOWEL
DECALS

VE0130



**THE CHAMP -
WHITE TOWEL**
DECALS

VE0131



**THE CHAMP -
BLUE TOWEL**
DECALS

VE0132



**75¢ JUMBO
BLU-SHAM**
DECALS

VE0106



**JUMBO
NU-SHAM**
DECALS

VE0126



MOISTWIPE
DECALS

VE0103



AQUA TOWEL
DECALS

VE0103B



SUPER TOWEL
DECALS

VE0103T



**JUST FOR
LEATHER**
DECALS

DEV18



**GLASS
CLEANER WIPES**
DECALS

DEV25



**BLACK JACK
WIPES**
DECALS

DEV35



**NEVER FOG
WIPES**
DECALS

DEV40

DECALS

TOWEL AND CLEANER DECALS FOR SINGLE-COLUMN VENDORS

• Decals are peel and stick

FREE



LEATHER & VINYL SPONGE

SMD700



PROTECTANT SPONGE

ARD100



CLEANER SPONGE

ARD150



PROTECTANT 4 OZ.

ARD123



TIRE FOAM 4 OZ.

ARD200



MULTI-PURPOSE

ARD500



AUTO GLASS CLEANER

ARD501



WHEEL & TIRE

ARD502



TIRE SHINE 4 OZ.

ARD503



LEATHER WIPES

ARD504



PROTECTANT WIPES

ARD505



CLEANING WIPES

ARD506



GLASS WIPES

ARD507



ULTRA SHINE TRIM & TIRE SHINE

ARD276



BLUE CLOTH TOWEL

VE0150



TERRY TOWEL

VE0151



BIG WHITE TOWEL

DEBWT



KLEEN-SHAM

VE0155



50¢ TOWEL

VE0122



MICROFIBER TOWEL

VE0121-BK



MICROFIBER TOWEL

VE0121



WHITE TRUCK TOWEL

VE0135



BIG BLUE TOWEL

VE0136

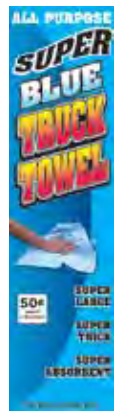

BLUE TRUCK TOWEL

VE0138

DECALS

TOWEL AND CLEANER DECALS FOR SINGLE-COLUMN VENDORS

• Decals are peel and stick

FREE



BLUE CLOTH TOWEL

VE0102



DETAILING DIAPER

VE0112



GLASS CLEANER WITH TOWEL

VE0113



3 ACTION WINDOW

VE0119



GLASS CLEANER

VE0168



TRIPLE WASH TOWEL

VE0116



INTERIOR CLEANER

VE0178



TERRY TOWEL

VE0114



MICROFIBER TOWEL

VE0148



CLEANZ ALL

VE0175



TIRE SHINE 4 OZ.

VE0169



WHEEL CLEANER

VE0170



WAFFLE WEAVE TOWEL

VE0176



LOVE BUG REMOVER

VE0171



ALL AMERICAN BLUE

VE0161



ALL AMERICAN WHITE

VE0162



ALL AMERICAN BLUE XXL

VE0163



ALL AMERICAN WHITE XXL

VE0164

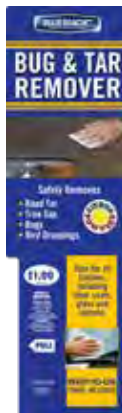

TAR & BUG

DEV19



JUST FOR LEATHER

DEV17



HEADLIGHT LENS RESTORER

DEV725



HEADLIGHT LENS SEALER

DEV730



METAL POLISH

DEV235



VINYL PLUS CLEANER

DEV16

DECALS

TOWEL AND CLEANER DECALS FOR SINGLE-COLUMN VENDORS

DECALS

- Decals are peel and stick

FREE



SCRUBBIE PADS
DECALS

VE0125

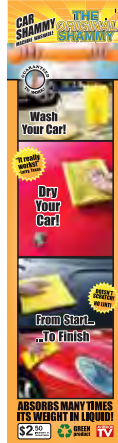

ORIGINAL SHAMMY
DECALS

VE0152



RAIN WIPES
DECALS

RWD100



MAGNA SHINE
DECALS

VE0108



HUGE & HEFTY TOWEL
DECALS

DEA8420-1



MAGIC SPONGE
DECALS

VE0159



GLASS CLEANER FOAM
DECALS

VE0127



GLASS WIPES
DECALS

SMD800



CLEANING WIPES
DECALS

SMD825



CLEANER
DECALS

SMD500



PROTECTANT
DECALS

SMD400



1 STEP POLISH
DECALS

SMD600



WHEEL CLEANER
DECALS

SMD10



TIRE SHINE
DECALS

SMD200



AUTO GLASS
DECALS

SMD300

DECALS

TRIPLE-COLUMN OVERLAYS FOR TOWELS & CLEANERS

DECALS

• Decals are peel and stick

FREE



**ARMOR ALL®
CAR CARE CENTER**
DECAL

ARD300



**SIMONIZ® VENDING
CENTER**
DECAL

SMD900



**CAR WASH
VENDING CENTER**
DECAL

DEDEC3



**QUICKDRY®
VENDING CENTER**
DECAL

VE0115



**QUICKDRY®
DETAIL CENTER**
DECAL

VE0149



**CAR CARE
VENDING CENTER**
DECALS

VE0160



**DOG WASH
VENDING CENTER**
DECALS

PTW128

TRIPLE-COLUMN OVERLAY DECALS FOR DOG WASH VENDING CENTER

DECALS

• 4" x 10" Decals

FREE



**PEANUT BUTTER
AND HONEY TREATS**
DECALS

PTW175-PB-0



**CHEESE & BACON
TREATS**
DECALS

PTW175-CB-0



PONCHOS
DECALS

PTW170D



PET TOWEL
DECALS

PTW190



TERRY CLOTH TOWEL
DECALS

DEDSKRTT

**FREE SHIPPING IS ALWAYS
AVAILABLE ON PURCHASES OF
A FULL PALLET OF SOAP.**

Simply purchase a full pallet of soap, top it off with vending supplies and parts and we will ship it anywhere in the lower 48 states for free!

*See front inside cover for more details!

DECALS

TRIPLE-COLUMN OVERLAYS

DECALS

• 4" x 10" Vending Decals

FREE



JUST FOR LEATHER
DECALS

DEDJFL



GLASS CLEANER WIPES
DECALS

DEDSAG



BLACK JACK WIPES
DECALS

DEDSBJ



NEVER FOG
DECALS

DEDSNF



BUG & TAR WIPES
DECALS

DEDSBTR



VINYL PLUS WIPES
DECALS

DEDSVP



JUST FOR LEATHER 1 STEP
DECALS

DEDSL



INTERIOR CLEANING WIPES
DECALS

DEDSIC



BLUE CLOTH TOWEL
DECALS

DEDSQDC



QUICK DRY DETAIL DIAPER
DECALS

DEDSDD



2 OZ. GLASS CLEANER W/ TOWEL
DECALS

DEDSGC



QUICK DRY TERRY TOWEL
DECALS

DEDSQDT



TRIPLE WASH TOWEL
DECALS

DEDSQDTW



TRIPLE ACTION WINDOW CLEANER
DECALS

DEDTAWC



QUICK DRY MICROFIBER TOWEL
DECALS

DEDSQD-MF



ALL AMERICAN BLUE
DECALS

DEDP TBL



ALL AMERICAN WHITE
DECALS

DEDP TWL



ALL AMERICAN XXL BLUE
DECALS

DEDP TLBL



ALL AMERICAN XXL WHITE
DECALS

DEDP TXLWL



CLEANZ ALL 4 OZ.
DECALS

DEDS CA



WAFFLE WEAVE 4 OZ.
DECALS

DEDS WA

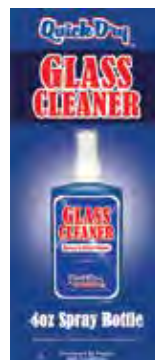

QUICK DRY 4 OZ. GLASS CLEANER
DECALS

DEDG C4L



TIRE SHINE 4 OZ.
DECALS

DEDS 4L



QUICK DRY WHEEL CLEANER
DECALS

DEDS WC



LOVE BUG REMOVER
DECALS

DEDS LB

DECALS

TRIPLE-COLUMN OVERLAYS

DECALS

• 4" x 10" Vending Decals

FREE



GLASS WIPE
DECALS

DEDS800



CLEANING WIPES
DECALS

DEDS825



TRAVEL WIPES
DECALS

DEDS850



PROTECTANT WIPES
DECALS

DEDS875



PROTECTANT GLOVE
DECALS

DEDS905

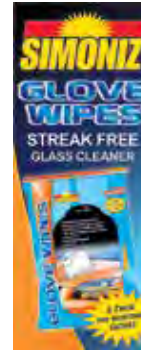

GLASS GLOVE
DECALS

DEDS910

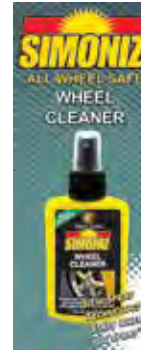

WHEEL CLEANER
DECALS

DEDS100FLAT



TIRE SHINE
DECALS

DEDS200FLAT

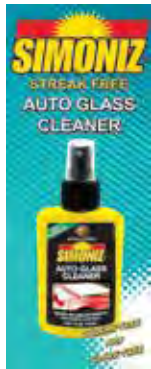

GLASS CLEANER
DECALS

DEDS300FLAT



PROTECTANT
DECALS

DEDS400FLAT

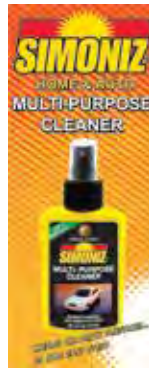

CLEANER
DECALS

DEDS500FLAT



ONE STEP POLISH
DECALS

DEDS600FLAT



LEATHER/VINYL PROTECTANT
DECALS

DEDS700



ARMOR ALL PROTECTANT
DECALS

DEDSAA



AA CLEANER SPONGE
DECALS

DEDSAAC



GLASS WIPES
DECALS

DEDS17240



AA AUTO GLASS
DECALS

DEDS17234



EXTREME WHEEL+TIRE
DECALS

DEDS17235



EXTREME TIRE SHINE
DECALS

DEDS17236



MULTI-PURPOSE
DECALS

DEDS17233



LEATHER WIPES
DECALS

DEDS17237



ORIGINAL PROTECTANT
DECALS

DEDS17238



CLEANING WIPES
DECALS

DEDS17239

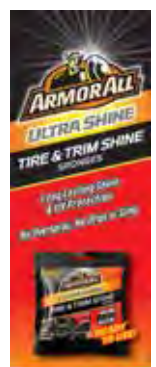

ULTRA SHINE TIRE & TRIM
DECALS

DEDS18276

DECALS

TRIPLE-COLUMN OVERLAYS

DECALS

• 4" x 10" Vending Decals

FREE



**BIG BOSS
MICROFIBER
TOWEL**
DECALS

DEDSKRMF



**BLACK
MICROFIBER
TOWEL**
DECALS

DEDSMF-BK



**BLUE
MICROFIBER
TOWEL**
DECALS

DEDSMF-BL



**WHITE
MICROFIBER
TOWEL**
DECALS

DEDSMF-W



**GREEN
MICROFIBER
TOWEL**
DECALS

DEDSMF-G



**ORANGE
MICROFIBER
TOWEL**
DECALS

DEDSMF-O



**RED
MICROFIBER
TOWEL**
DECALS

DEDSMF-R



**YELLOW
MICROFIBER
TOWEL**
DECALS

DEDSMF-Y



**SUPER TRUCK
TOWEL - WHITE**
DECALS

DEDS135



**BIG BLUE
TOWEL**
DECALS

DEDSBBT



**SUPER BLUE
TRUCK TOWEL**
DECALS

DEDSBTT



**BLUE CLOTH
TOWEL**
DECALS

DEDSBC



**BIG WHITE
TOWEL**
DECALS

DEDSBWT



KLEEN SHAM
DECAL

DEDSKS



MAGNASHINE
DECALS

DEDS108



CONDOMS
DECALS

DECONDOM



**ORIGINAL
SHAMMY**
DECALS

DEDS100



WET TOWEL
DECALS

DEDSWETT



**JUMBO
BLU-SHAM**
DECALS

DEDS4075

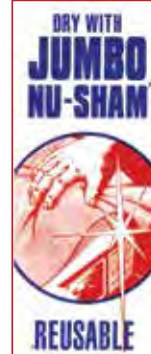

**JUMBO
NU-SHAM**
DECALS

DEDS5085



AQUA TOWEL
DECALS

DEDSGA



MOIST WIPE
DECALS

DEDSGM



SUPER TOWEL
DECALS

DEDSST

VENDOR DEALS



SINGLE-COLUMN VENDOR DEALS

VENDING

• Deals valid with the purchase of a vending machine. All deals include a FREE decal. PRICES OF VENDING MACHINES MAY VARY.

PRODUCT	PART #	DESCRIPTION	DEAL	AVAILABLE VENDORS
LITTLE TREES®	VS10155	BLACK ICE	4 - 72 packs 288 FREE LITTLE TREES®	VEL800CF
WET TOWELS	VS702	TOWELS	Buy 1 Case Get 1 Case FREE	VE0201, VEL800, VELL399MAX, VEL399MAXC, VEL399MAX-MA, VEL399MAX-MAC
GIANT TOWELS	VST2000	SUPER TRUCK TOWEL	Buy 1 Case Get 1 Case FREE	VE0201, VEL800, VELL399MAX, VEL399MAXC, VEL399MAX-MA, VEL399MAX-MAC
	VST50BB	BLUE TOWEL		
	VST3000	MOIST WIPES		
SIMONIZ FLAT BOTTLES	SM400FLAT	PROTECTANT	2 FREE Cases (One Type)	VEL800, VEL399B, VELL399MAX, VEL399MAXC, VEL399MAX-MA, VEL399MAX-MAC, VEL399BMAX, VEL399BMAX-MA
	SM500FLAT	MULTI-PURPOSE CLEANER		
	SM200FLAT	TIRE SHINE		
	SM300FLAT	AUTO GLASS CLEANER		
	SM100FLAT	WHEEL CLEANER		
	SM600FLAT	ONE STEP POLISH		

VENDOR DEALS

3 COLUMN VENDOR DEALS

VENDING

• Deals valid with the purchase of a vending machine. All deals include a FREE decal. PRICES OF VENDING MACHINES MAY VARY.

PRODUCT	PART #	DESCRIPTION	DEAL	AVAILABLE VENDORS
SIMONIZ FLAT BOTTLES	SM400FLAT	PROTECTANT	6 FREE Cases	VEL899, VEL899-MA, VEL899-X10, VEL899-QL
	SM500FLAT	MULTI PURPOSE CLEANER		
	SM200FLAT	TIRE SHINE		
	SM300FLAT	AUTO GLASS CLEANER		
	SM100FLAT	WHEEL CLEANER		
	SM600FLAT	ONE STEP POLISH		
SIMONIZ GLOVE BOX WIPES	SM825	CLEANING WIPES	3 FREE Cases	VEL899, VEL899-MA, VEL899-X10, VEL899-QL
	SM850	TRAVEL WIPES		
	SM800	GLASS WIPES		

3-COLUMN



5-COLUMN



5 COLUMN VENDOR DEALS

VENDING

• Deals valid with the purchase of a vending machine. All deals include a FREE decal. PRICES OF VENDING MACHINES MAY VARY.

PRODUCT	PART #	DESCRIPTION	DEAL	AVAILABLE VENDORS
LITTLE TREES	VS10189	NEW CAR	864 FREE LITTLE TREES 12 Boxes of 72	VE0206, VEL599MAX-MA, VEL599MAX-MAC
	VS10312	STRAWBERRY		
	VS10155	BLACK ICE		
	VS10105	VANILLAROMA		
	VS10324	CARIBBEAN COLADA		

KLEEN-PET® PROFESSIONAL PET CARE VENDING PRODUCTS



DECAL ONLY



DOG WASH VENDING MACHINE

PET WASH SUPPLIES & PARTS

- Stainless steel
- Large decal
- Push button selection
- Sensortron coin acceptor
- Stainless steel lock bar/frame
- 3 column electronic vending machine
- Digital display readout
- 24V operation
- Individual price programming

\$1,624.13	VEL899MAX	3 Column Vending Machine
\$2,017.27	VEL899MAXC	3 Column Vending Machine with Credit Card Swiper
\$20.99	PTW128	3 Column Decal - Overlays Available



FLAVORED DOG TREATS

PET WASH SUPPLIES & PARTS

- 1 oz. package - 100 packages per case
- **PEANUT BUTTER TREATS:** Barley flour, palm oil, honey, rolled oats, peanut butter, oat flour, coconut oil, flax, peanut flour
- **CHEESE & BACON TREATS:** Barley flour, palm oil, honey, rolled oats, cheddar cheese, flax, coconut oil, natural bacon flavor

\$84.38	PTW175-PB	Peanut Butter & Honey Treats
FREE	PTW175-PB-0	Peanut Butter & Honey Treats Overlay

\$84.38	PTW175-CB	Cheese & Bacon Treats
FREE	PTW175-CB-0	Cheese & Bacon Treats Overlay



WAFFLE WEAVE TOWEL

PET WASH SUPPLIES & PARTS

- 12 per case
- 17" x 26"

\$21.57	VS171	Towels
FREE	PTW190	Overlay



RAINWIPES® MICROFIBER TOWEL

PET WASH SUPPLIES & PARTS

- Dries 10x faster than regular rags

\$70.39	PTW600	12" x 16" (100/case)
\$132.00	PTW610	24" x 16" (100/case)



THE ORIGINAL SHAMMY

PET WASH SUPPLIES & PARTS

- 120 per case - individually wrapped
- 12.5" x 16.75"
- Assorted orange, blue & yellow
- Holds up to 21 times its weight in liquid
- Machine washable & bleachable

\$135.19	SHAM100	120/case
FREE	DEDS100	Overlay
	VE0152	Single Col. Decal



TERRY CLOTH DRYING TOWEL

PET WASH SUPPLIES & PARTS

- 100 per case, folded & wrapped
- Super large, absorbent & reusable
- 100% cotton

\$57.52	VSKTT100W	Towels
FREE	DEDSKRTT	Overlay



FOLDING PET BRUSH

PET WASH SUPPLIES & PARTS

- 24 brushes per case

\$64.08	PTW130
----------------	---------------



RAIN PONCHO

PET WASH SUPPLIES & PARTS

- 25 per case
- Adult size

\$37.68	PTW170	Poncho
FREE	PTW170D	Overlay

LAUNDRY VENDING



GAIN LAUNDRY DETERGENT LAUNDRY VENDING

- Powder, 156 per case

\$88.69 LD1800



TIDE DETERGENT LAUNDRY VENDING

- Powder, 156 per case

\$88.69 LD1000



TIDE WITH BLEACH LAUNDRY VENDING

- Powder, 156 per case

\$88.69 LD1050



OXY CLEAN LAUNDRY VENDING

- 1 oz., 156 per case

\$79.39 LD1500



ALL STAIN LIFTER DETERGENT LAUNDRY VENDING

- Powder, 100 per case

\$56.19 LD2900



ALL FREE & CLEAR DUAL PACK LAUNDRY VENDING

- Detergent/Dryer Sheets - 100 Per Case

\$64.00 LD3200



ALL FREE & CLEAR DRYER SHEETS LAUNDRY VENDING

- 2 pack, 100 per case

\$34.55 LD3100



ALL FREE & CLEAR LIQUID LAUNDRY VENDING

- Liquid, 100 per case

\$49.93 LD3000



SNUGGLE FABRIC SOFTENER LAUNDRY VENDING

- Liquid, 100 per case

\$48.88 LD2100



SNUGGLE DRYER SHEETS LAUNDRY VENDING

- 2 Pack, 100 per case

\$34.25 LD1700



BOUNCE DRYER SHEETS LAUNDRY VENDING

- 2 Pack, 156 per case

\$88.69 LD1100



DISOL-VOL STAIN REMOVER LAUNDRY VENDING

- 100 per case

\$51.45 LD2800



DOWNY FABRIC SOFTENER LAUNDRY VENDING

- Liquid, 156 per case

\$88.69 LD1300

New!



DOWNY UNSTOPPABLES IN-WASH SCENT BOOSTER LAUNDRY VENDING

- 1.37oz beads per pack, 156 per case

\$83.78 LD3210



CLOROX BLEACH LAUNDRY VENDING

- Liquid, 54 per case

\$26.89 LD1400



CLOROX 2 LAUNDRY VENDING

- Powder 154 per case

\$66.08 LD1200

BILINGUAL LAUNDRY "USE LESS SOAP" DECALS LAUNDRY VENDING

- Decal Reads: "Use Less Soap... For Best Results Use "HE" detergent, any other products use 1/4 (1/3, 1/2) of the recommended amount" in English and Spanish.



1/4 CUP USE LESS SOAP BILINGUAL DECALS

- Bilingual decal

\$8.45 LD0015



1/3 CUP USE LESS SOAP BILINGUAL DECALS

- Bilingual decal

\$8.45 LD0020



1/2 CUP USE LESS SOAP BILINGUAL DECALS

- Bilingual decal

\$8.45 LD0025

LAUNDRY VENDING



50¢ VENDRITE BAGS

- 144 bags per case
- Plastic - 1 per box
- Fits in soap vendor

\$49.63 LD2500



50¢ VENDRITE BAGS

- 144 bags per case
- Plastic - 1 per box
- Fits in bag vendor

\$49.31 LD2400



75¢ VENDRITE BAGS

- 120 bags per case
- Plastic - 1 per box
- Fits in bag vendor

\$64.19 LD2600



50¢ LAUNDROSAK®

- 154 bags per case
- Plastic - 1 per box
- Fits in soap vendor

\$68.67 LD2200



50¢ LAUNDROSAK®

- 154 bags per case
- Plastic - 1 per box
- Fits in bag vendor

\$68.67 LD2300



75¢ SUPERSAK®

- 126 bags per case
- Plastic - 1 per box
- Fits in bag vendor

\$80.31 LD2700



OUT OF SERVICE TAG LAUNDRY ACCESSORIES

- 50 pack

\$16.13 LD0011

Check out the new **LAUNDRY & JANITORIAL** section after **CHEMICALS** for even more products! We now carry laundry carts, chemicals, and much, much more!

3-COLUMN LAUNDRAMAX VENDING MACHINE

LAUNDRY VENDING

- Soap box vending machine
- Slugbuster coin acceptor
- Digi-Max display included
- 24V AC power required
- Transformer required, sold separately

\$1,624.13	VEL899LMAX	3-Column Laundramax Soap Box Vending Machine w/ Slugbuster & Digi-Max Display
\$2,017.27	VEL899LMAXC	3-Column Laundramax Soap Box Vending Machine w/ Slugbuster, Digi-Max Display, & CryptoPay Swiper
\$1,705.27	VEL899LMAX-MA	3-Column Laundramax Soap Box Vending Machine w/ MA850 & Digi-Max Display
\$2,097.05	VEL899LMAX-MAC	3-Column Laundramax Soap Box Vending Machine w/ MA850, Digi-Max Display, & CryptoPay Swiper
FREE	VE0133	3-Column Decal



CRYPTOPAY OFFERS THE MOST SECURE AND COST EFFECTIVE CHOICE FOR ADDING CREDIT CARD ACCEPTANCE AT YOUR LAUNDRY.

- CryptoPay Transaction Consolidation reduces your transaction fees.
- CryptoPay Wireless Credit Card Swipers reduces your installation time and cost.
- CryptoPay Credit Card Security prevents credit card data from being "in the clear" and at risk.
- With a LOW startup cost and no minimum card reader purchase, why not add CryptoPay to your laundry today?



SEE THE NEW ITEMS SECTION OR THE EQUIPMENT SECTION FOR MORE DETAILS!





ARMOR ALL PRODUCTS ARE NOT FOR EXPORT

ARMOR ALL® TUB WIPES

TUB WIPES

ARMOR ALL

• 6 tubs per case



CLEANER

ARMOR ALL TUB WIPES

• 30 wipes per tub

\$25.35 AR10863

PROTECTANT

ARMOR ALL TUB WIPES

• 30 wipes per tub

\$25.35 AR10861

GLASS CLEANER

ARMOR ALL TUB WIPES

• 30 wipes per tub

\$25.35 AR10865

LEATHER

ARMOR ALL TUB WIPES

• 30 wipes per tub

\$25.35 AR10881

ULTRA SHINE

ARMOR ALL TUB WIPES

• 20 wipes per tub

\$25.35 AR10945

AIR FRESHENING TUB WIPES

ARMOR ALL

• 6 tubs per case • 25 wipes per tub

\$25.35



EXTREME SHIELD PLUS CERAMIC

ARMOR ALL TUB WIPES

AR31400

HEAVY DUTY

ARMOR ALL TUB WIPES

AR32900

ORANGE CLEANING

ARMOR ALL TUB WIPES

AR10831

CLEANING

ARMOR ALL TUB WIPES

AR17952

COOL MIST

ARMOR ALL PROTECTANT

AR78509

NEW CAR

ARMOR ALL PROTECTANT

AR78533



ARMOR ALL® 3 PACK OF WIPES

ARMOR ALL TUB WIPES

• 25 wipes per tub
• 1 tub of each of the following wipes: Protectant, Glass, Cleaning

\$11.11 AR44983



TUB WIPES 24 PIECE FLOOR DISPLAY

ARMOR ALL TUB WIPES

DISPLAY CONTAINS:

- 8 Tubs of Protectant
- 8 Tubs of Glass Cleaner
- 4 Tubs of Cleaning Wipes
- 4 Tubs of Leather Wipes

\$108.07 AR78491



ARMOR ALL® TARGETED CARE PRODUCTS

ARMOR ALL PRODUCTS ARE NOT FOR EXPORT

New!



WHEEL & TIRE
ARMOR ALL PROTECTANT

• 6 per case, 16 oz.

\$39.44 AR39855

New!



PROTECT & SHINE
ARMOR ALL PROTECTANT

• 6 per case, 16 oz.

\$43.76 AR39859



NEW CAR
ARMOR ALL PROTECTANT

• 6 per case, 16 oz.

\$34.60 AR78529



COOL MIST
ARMOR ALL PROTECTANT

• 6 per case, 16 oz.

\$34.60 AR78511



MULTI-PURPOSE
ARMOR ALL SPRAYS

• 6 per case, 16 oz.

\$15.67 AR17951



DETAILER
ARMOR ALL SPRAYS

• 5 per case, 16 oz.

\$34.74 AR27837

ARMOR ALL® FRESHFX™ RETAIL PRODUCTS

ARMOR ALL PRODUCTS ARE NOT FOR EXPORT

FRESHFX™ ODOR ELIMINATORS

ARMOR ALL

• 1.5 oz per can • 6 single packs per case

\$25.75

FRESHFX™ SMOKE X ODOR ELIMINATORS

ARMOR ALL

• 2 oz per can • 6 single packs per case

\$29.68



TRANQUIL SKIES
FRESHFX ELIMINATORS

AR18505



CHERRY BLAST
FRESHFX ELIMINATORS

AR19143



ISLAND OASIS
FRESHFX ELIMINATORS

AR19144



MIDNIGHT AIR™
FRESHFX ELIMINATORS

AR18956



CITRUS BREEZE™
FRESHFX ELIMINATORS

AR19142



FRESHFX™ VENT & DUCT CLEANER

ARMOR ALL

- 5 oz canister - 6 canisters per case
- Cleaner and odor neutralizer lets you treat vents, ductwork, evaporator core, and drain pan area. Helps eliminate many odors caused by mold and mildew. Removes light dirt from ductwork and vent surfaces.
- Tranquil Skies scent

\$18.06 AR18546

FRESHFX™ SMOKE X™ SPRAY

ARMOR ALL

• 3.5 oz. canister - 24 canisters per case

\$79.05



MIDNIGHT AIR™
ARMOR ALL

AR18960



CITRUS BREEZE™
ARMOR ALL

AR19190



ARMOR ALL PRODUCTS ARE NOT FOR EXPORT

ARMOR ALL® TARGETED CARE PRODUCTS



EXTREME SHIELD + CERAMIC LEATHER CLEANER

ARMOR ALL

- SiO2 based long-lasting stain repellent
- Dye-free, safe for heated seats and perforated leather
- UV blockers protect and maintain

\$29.14 AR52900 6 Per Case



EXTREME SHIELD PROTECTANT

ARMOR ALL

- 5-in-1 formula with protecting power
- Blocks stains
- Cleans plastic, rubber and vinyl
- Protects from UV damage
- Enhances color depth

16 OZ. SPRAY BOTTLE

ARMOR ALL

\$38.14 AR19134 6 Per Case

25 CT. TUB WIPES

ARMOR ALL

\$29.00 AR19145 6 Per Case



LEATHER CARE

ARMOR ALL

- Safely cleans, conditions while blocking harmful UV rays
- Protects the look and feel of leather surfaces

18 OZ. GEL BOTTLE

ARMOR ALL

\$24.64 AR45017 4 Per Case

16 OZ. SPRAY BOTTLE

ARMOR ALL

\$37.31 AR78175 6 Per Case

EXTREME SHIELD + CERAMIC CLEANING SPRAY

ARMOR ALL

- 16oz. spray bottles, 6 bottles per case
- Ceramic stain repelling technology

\$31.06 AR32600



EXTREME SHIELD + GRAPHENE SPRAY COATING

ARMOR ALL

- Graphene, one of the hardest materials on earth - is rapidly growing in popularity in the auto detailing and car washing world
- 16 oz spray bottles, 6 bottles per case
- Graphene technology that repels water and dirt

\$31.06 AR26100



ULTRA SHINE TOTAL VEHICLE DETAILER

ARMOR ALL

- 22 oz. per bottle, 6 bottles per case
- Cleans and details interiors - Use on vinyl, plastic and leather
- Reveals natural luster on glass, paint and wheels

\$33.52 AR18931



HEAVY DUTY MULTI-PURPOSE CLEANER

ARMOR ALL

- 24 oz. per bottle, 6 bottles per case
- Powerful cleaning - cuts through dirt, grease and oil
- For interior/exterior use

\$33.52 AR19137



MULTI-PURPOSE CLEANER

ARMOR ALL

- 16 oz. per bottle, 6 bottles per case
- All-in-one cleaning solution. Effective for the whole car including dash, vinyl, fabric, carpet, clear plastic console and more.

\$15.67 AR78513



EXTREME BUG & TAR REMOVER

ARMOR ALL ULTRA SHINE

- 16 oz. per bottle - 6 bottles per case
- Streak-free formula maintains vehicle's finish and preserves wax protection. Rids vehicle surfaces of bugs, tar and bird droppings.

\$22.48 AR18498





ARMOR ALL® TARGETED CARE PRODUCTS



TUFF STUFF® MULTI-PURPOSE FOAM ARMOR ALL

- 22 oz. per can - 6 cans per case
- Foaming formulation helps lift dirt
- Effective on: fabric upholstery, floor mats, painted walls, fixtures, and tile. Even works on stains on vinyl and fabrics

\$20.30 AR13147



TUFF STUFF® STAIN REMOVER ARMOR ALL

- 18 oz. per can - 6 cans per case
- Deep cleans stains on carpets and fabrics
- Bristled cap stands up to heavy-duty usage without breaking or bending

\$25.15 AR17182



ARMOR ALL RETAIL PRODUCTS, THE PRODUCTS TO BEAT AND THE WAXES TO OUTDO.

These long lasting products will keep you satisfied from your vending machines all the way to your retail shelves. For decades and decades, Armor All Retail Products have displayed sufficient progress and continue to grow as a whole.

ARMOR ALL® WHEEL & TIRE CARE PRODUCTS



EXTREME WHEEL & TIRE CLEANER ARMOR ALL

- Available in 24 oz. and 32 oz. bottles, 6 per case
- Removes brake dust with no scrubbing
- Dissolves grease, road grime & brake dust
- Intense foaming action clings to wheels and lifts away soils
- Safe for all wheels when used as directed

\$27.66 AR40330 24 oz.
\$33.58 AR78011 32 oz.



EXTREME TIRE SHINE ARMOR ALL

- Conditions, nourishes, and preserves the rich black look of your tires
- Protects from harmful elements that cause cracking and fading
- Long-lasting, high-gloss shine

22 OZ. SPRAY BOTTLE ARMOR ALL

\$20.35 AR78004 6 bottles per case

15 OZ. AEROSOL CAN ARMOR ALL

\$32.59 AR77958 6 bottles per case



TIRE FOAM ARMOR ALL

- 20 oz. can, 6 cans per case
- Cleans, darkens, and nourishes tires for continued protection against ozone degradation. Such degradation may dry out tires, causing fading and cracks.

\$24.55 AR13682



EXTREME TIRE FOAM ARMOR ALL

- 18 oz. can, 6 per case
- Intense foam activates on contact, floating dirt away without scrubbing
- Conditioners nourish and restore tires' deep black look
- Blocking agents protect from harmful elements that can cause cracking and fading

\$28.55 AR18930



ULTRA SHINE TIRE FOAM ARMOR ALL

- 18 oz. can, 6 cans per case
- High gloss shine
- Precision applicator reduces messy overspray
- Intense foaming action powers through tough dirt and grime
- Protects against harmful elements that can cause fading and cracking

\$26.42 AR14900



ARMOR ALL PRODUCTS ARE NOT FOR EXPORT

ARMOR ALL® TARGETED CARE PRODUCTS



ORIGINAL PROTECTANT SPRAYS

ARMOR ALL

- Guards against UV damage
- Trusted protection of Armor All Protectant in hassle-free spray form
- Helps prevent cracking, fading, discoloration, and premature aging
- Enhances vehicle's deep, rich look and adds attractive shine
- Designed for use on dashboards, vinyl seats, door panels, consoles, tires, trims, and bumpers. Do not use on floors, pedals, grips, steering wheels, bench or cycle seats, cycle tires, or brake drums
- Do not use on clear plastic surfaces, glass, fabric, paint, or woven materials
- Save money by buying in bulk; stock up your shop or use them for resale

\$36.00	AR11080	8 oz.	12 Per Case
\$43.36	AR11010	10 oz.	12 Per Case
\$67.63	AR27913	16 oz.	12 Per Case

\$35.41	AR27899	32 oz.	4 Per Case
\$30.38	AR10710	1 Gallon	Per Gallon

LEATHER CARE WITH BEESWAX

ARMOR ALL

- Features real beeswax to nourish and preserve leather's rich, soft, supple look and feel
- Cleans, conditions, and protects leather
- Non-greasy formula effectively removes dirt/soil
- Helps protect from drying, aging, and cracking
- Nourishes and preserves leather's rich, soft, supple look and feel

WIPES

- 25 wipes per tub - 6 tubs per case

\$25.35 AR18933

SPRAY

- 16 oz. bottle - 6 bottles per case

\$39.15 AR18934

ULTRA SHINE WASH & WAX

ARMOR ALL

- Gently lifts away scratch & swirl causing dirt
- Helps water beading on paint
- Delivers mirrorlike shine as you wash
- Reveals your paint's deep, radiant color

\$16.64	AR25178	16 oz.	6/Case
\$5.88	AR10346	64 oz.	1/Case

CAR WASH CONCENTRATE

ARMOR ALL

- 24 oz. per bottle - 6 bottles per case
- Lifts away dirt and road grime but won't strip wax
- Clean-rinsing formula for spot-free and streak-free results
- Safe for automotive clear coat finishes

\$16.96 AR25024 16 oz. 6/Case



AUTO GLASS SPRAY

ARMOR ALL

- 22 oz. bottle - 6 bottles per case
- Meets VOC regulations in all 50 states
- Removes filmy residue, road grime, bugs, and fingerprints
- Ammonia-free formula is safe for use on auto glass
- Safe on interior, exterior, and tinted glass when used as directed

\$16.92 AR32024



New!

CAR WASH PODS

ARMOR ALL

- 18 pods per pouch - 6 pouches per case
- One pod washes one car
- Dissolves in warm or cold water
- Lifts away dirt and grime
- Formula rinses away without streaking
- Great for foam cannons and bucket washing

\$46.10 AR39848



SNOW FOAM WASH

ARMOR ALL

- 50 oz. bottle - 4 bottles per case
- High-foaming cleaner that is applied by hand or with a foam sprayer. This formula clings to the vehicle surface like snow buildup, increasing its cleaning power. Its pH-balanced chemistry makes it safe for waxes, sealants, and other protective coatings.

\$27.73 AR19141





ARMOR ALL® WIPES, TOWELS & KITS

ARMOR ALL PRODUCTS ARE NOT FOR EXPORT



MULTI-PURPOSE TOWELS

ARMOR ALL

- 24 per pack

\$21.72 AR17622



MICROFIBER DRYING TOWELS

ARMOR ALL

- 6 per pack

\$33.90 AR17621



MICROFIBER WASH MITT

ARMOR ALL

- 8 per case

\$25.08 AR17614



POUCH WIPES

ARMOR ALL

CLEANING WIPES

- 20 wipes per pack, 6 packs per case

\$17.25 AR18242

ORIGINAL PROTECTANT

- 20 wipes per pack, 6 packs per case

\$17.25 AR18241



ULTRA SHINE HEADLIGHT RESTORATION WIPES

ARMOR ALL

- 6 wipes per box - 6 boxes per case
- Wipes away oxidation from car headlights and applies UV sealant protection
- Avoid contact with painted surfaces

\$40.97 AR18514



COMPLETE CAR CARE KIT

ARMOR ALL

- A complete car care kit for car enthusiasts! Great for gifts, giveaways, or retail applications. Includes everything you need to improve your car's brilliant shine and rich look.
- The Original Protectant fights interior fading and aging when sprayed on interior car surfaces. The Ultra Shine Wash & Wax is perfect for car washing anytime, anywhere; apply to the entire vehicle. The Tire Foam Protectant cleans tires and restores their natural, deep black look. Wipe away dirt and grime with ease with Armor All Glass Wipes. Achieve excellent clarity, shine, and cleanliness with this complete car care kit!

KIT INCLUDES:

- 10 oz. Original Protectant • 16 oz. Ultra Shine Wash & Wax
- 20 oz. Tire Foam Protectant • 25 Count Glass Wipes

\$16.50 AR13703

BLUE MAGIC® PRODUCTS



CARPET STAIN & SPOT LIFTER BLUE MAGIC

- 22 oz. can - 6 cans per case
- Instant - no vacuuming
- Works when others fail
- Lifts coffee, grease, pet stains & more

\$31.63 VSNA900



METAL POLISH CREAM BLUE MAGIC

- 7 oz. jar - 6 jars per case
- Non-abrasive works on brass, copper, sterling silver, aluminum, stainless steel, and gold
- Removes tarnish & oxidation
- Can use with buffers and polishers

\$31.34 VSNA400



LEATHER AND VINYL CLEANER BLUE MAGIC

- 16 oz. spray bottle - 6 bottles per case
- Safe for all leather & vinyl
- Use on: Auto, truck, household and sports equipment
- Easy to use trigger spray

\$27.50 VSNA800



HEADLIGHT LENS RESTORER BLUE MAGIC

- 8 oz. bottle - 6 bottles per case
- Restores optical clarity by eliminating haze
- Improves visibility and safety

\$27.35 VSNA725



LEATHER CREAM AND CONDITIONER BLUE MAGIC

- 16 oz. spray bottle
- 6 bottles per case
- Moisturizes and preserves all leather
- Works great on vinyl
- Trigger spray application

\$31.00 VSNA850



QUIKSTEEL BLUE MAGIC

- 6 Per Case
- Reinforced epoxy putty
- Withstands temperatures up to 500° F
- Sets in 5 minutes and hardens like steel
- Drinking water safe, NSF-16

\$24.80 VSNA16002

LOCTITE® PRODUCTS



REARVIEW MIRROR ADHESIVE KIT LOCTITE RETAIL PRODUCTS

- 12 Kits Per Case
- Each kit contains (1) 0.01 fl. oz. adhesive and (1) .02 fl. oz. activator

\$35.68 LOC37438 California PROPOSITION 65



QUICKTITE® SUPER GLUE LOCTITE RETAIL PRODUCTS

- .14 oz. Quicktite Gel Package
- 1 Package Per Case

\$3.64 LOC39123 California PROPOSITION 65



STP® CAR CARE & FUEL ADDITIVES

STP PRODUCTS ARE NOT FOR EXPORT



PRO-SERIES CITRUS SCENT WIPES STP CAR CARE PRODUCTS

- 30 wipes - 6 pouches per case
- Large size degreasing wipes
- Cleans up oil, grease, and grime in garages and shops
- Absorbs up to 40% more oil versus leading degreasing wipes

\$38.05 STP10100



GAS TREATMENT STP CAR CARE PRODUCTS

- 5.25 oz. - 12 per case
- Improves the quality of gas and keeps fuel injectors and intake valves clean

\$28.49 STP78573

OTHER VEHICLE ENGINE CARE PRODUCTS STP CAR CARE PRODUCTS

6 PER CASE		
\$9.89	STP18667	Power Steering Fluid
\$23.66	STP65464	Power Steering Fluid
\$12.48	STP18666	Power Steering, Stop Leak
\$14.18	STP18669	Brake Fluid
12 PER CASE		
\$61.23	STP78587	Fuel System Cleaner For Ethanol
\$42.00	STP66079	Oil Treatment



SYNTHETIC OIL TREATMENT STP CAR CARE PRODUCTS

- 15 oz. - 6 bottles per case
- Extra protection for extended oil drain intervals
- Protect against engine wear
- Combats engine deposits
- Helps enhance oil durability

\$28.77 STP17881



OCTANE BOOSTER STP CAR CARE PRODUCTS

- 5.25 oz. - 12 bottles per case
- Increase octane level in fuel system
- Helps restore power and acceleration - treats up to 21 gallons!

\$50.99 STP78574



FUEL INJECTOR & CARBURETOR TREATMENT STP CAR CARE PRODUCTS

- 5.25 oz. - 12 bottles per case
- Fights deposit buildup and engine friction - treats up to 21 gallons!

\$26.06 STP78571



PRO-SERIES 3-IN-1 LUBRICANT SPRAY STP CAR CARE PRODUCTS

- 11 oz. can - 6 cans per case
- Penetrant & lubricant + anti-rust protection
- For use in home and auto
- Penetrates stubborn rust, quiets squeaky hinges and protects against rust & corrosion

\$34.16 STP18274



ALL SEASON WATER REMOVER STP CAR CARE PRODUCTS

- 5.25 oz. - 12 bottles per case
- Fights fuel line freeze and corrosion year round - treats up to 21 gallons
- All-season use

\$21.55 STP78572



FUEL SYSTEM CLEANER STP CAR CARE PRODUCTS

- 5.25 oz. - 12 bottles per case
- Removes deposits from entire fuel system - treats up to 21 gallons!

\$69.00 STP78568



DIESEL FUEL INJECTOR TREATMENT STP CAR CARE PRODUCTS

- 20 oz. - 6 bottles per case

\$28.42 STP78380



SUPER CONCENTRATED FUEL INJECTOR CLEANER STP CAR CARE PRODUCTS

- 5.25 oz - 12 singles per case | Value pack (2 singles) - 6 pks per case
- Unclogs dirty fuel injectors to restore performance in one treatment

\$38.73	STP78575	Single Pack
\$34.57	STP78577	Value Pack



MEGUIAR'S® CAR CARE PRODUCTS



ULTIMATE BLACK PLASTIC RESTORER

MEGUIAR'S

- Restores to a like-new appearance. Simply apply to a clean, dry surface. This self-leveling restorer dries to the touch in minutes! Extremely durable—lasts months through rain and washing!

12 OZ. CREAM

MEGUIAR'S

- 6 bottles per case

\$49.44 MGR15812

10 OZ. AEROSOL

MEGUIAR'S

- 6 cans per case

\$64.40 MGR16910

MGR15812 MGR16910



ULTIMATE LIQUID & PASTE WAX KITS

MEGUIAR'S

- Made with synthetic polymers
- ThinFilm technology

BOX INCLUDES:

- 1 Ultimate Paste Wax or Liquid Wax
- Foam Applicator Pad
- Supreme Shine™ Microfiber Towel

LIQUID WAX

MEGUIAR'S

- 4 packages per case

\$82.72 MGR210516

PASTE WAX

MEGUIAR'S

- 4 packages per case

\$83.25 MGR210608



ULTIMATE INSANE SHINE™ TIRE COATING

MEGUIAR'S

- 15 oz. cans - 6 cans per case
- Synthetic polymer chemistry delivers our highest gloss tire shine!
- Aerosol spray

\$52.80 MGR190315



ULTIMATE INSANE SHINE FOAM

MEGUIAR'S

- 19 oz. can - 6 cans per case
- Synthetic polymer chemistry provides a long-lasting finish with a soaking wet-look
- Powers through road grime for a dark, even shine

\$45.76 MGR210419



ULTIMATE ALL WHEEL CLEANER

MEGUIAR'S

- 24 oz. bottle - 4 bottles per case
- Active gel quickly dissolves heavy brake dust
- Acid-free and pH balanced formula
- Safe for all wheel finishes and painted brake components

\$36.53 MGR180124



ULTIMATE QUIK DETAILER

MEGUIAR'S

- 24 oz. bottles - 6 bottles per case
- New polymer chemistry provides an easier wipe off and slicker finish
- Quickly and safely removes dust and surface contaminants between washings
- Strengthens wax protection while enhancing shine
- Hydrophobic Polymer Technology provides extreme water beading action

\$68.56 MGR201024



ULTIMATE INSANE SHINE PROTECTANT SPRAY

MEGUIAR'S

- 16 oz. bottle - 6 bottles per case
- Contains UV screeners to help maintain the appearance of vinyl, plastic and rubber surfaces

\$48.24 MGR220216



ULTIMATE LEATHER DETAILER

MEGUIAR'S

- 16 oz. bottles - 6 bottles per case
- Premium 3-in-1 cleans, conditions and protects leather in one easy step
- Creates a rich, satin gloss without a greasy look/feel
- Conditions and moisturizes while durable polymers and UV blockers protect and maintain

\$52.96 MGR201316



ULTIMATE QUIK WAX

MEGUIAR'S

- 24 oz. bottles - 6 bottles per case
- Leaves behind a longer-lasting protective barrier
- Hydrophobic Polymer Technology provides extreme water beading action
- Easy-to-use formula makes paint come alive with deep, wet-look reflections and a super slick finish
- All-new spray formula provides a uniform mist that atomizes to perfection

\$68.56 MGR200924



MEGUIAR'S® CAR CARE PRODUCTS



QUIK DETAILER

MEGUIAR'S

- 16 oz. bottle - 6 bottles per case
- Can be used for Spot Touch Ups or to "quick detail" entire vehicle
- Removes fresh contaminants before damage occurs

\$36.80 MGR3316



QUIK WAX

MEGUIAR'S

- 24 oz. bottle - 6 bottles per case
- New formula darkens, adding amazing gloss, even in full sun - won't whiten trim
- Use on either wet or dry surfaces

\$39.04 MGR1624



PERFECT CLARITY GLASS CLEANER

MEGUIAR'S

- 6 bottles per case
- Protects against future hazing
- Ammonia-free, safe on window tint!

\$28.48 MGR8224



SCRATCH-X 2.0 SCRATCH REMOVER

MEGUIAR'S

Remove light scratches from paint finishes with Meguiar's ScratchX 2.0! Exclusive super micro-abrasive technology removes fine fingernail marks, paint transfer and scuffs from wear and tear of the paint surface quickly and easily.

- 7 oz. bottle - 6 bottles per case
- Safe on all glossy paints and clear coats (not for use on matte/satin finishes).
- Safe and effective application by hand or dual action polisher like Meguiar's MT300 Dual Action Polisher

\$57.28 MGR10307



QUIK INTERIOR DETAILER CLEANER

MEGUIAR'S

- Great for quick touch-ups (try it on your show floor!)
- Cleans, conditions and protects
- Use on any vehicle interior surface

16 OZ. BOTTLE
MEGUIAR'S

- 6 bottles per case

\$32.80 MGR13616

30 WIPE CANISTER
MEGUIAR'S

- 6 canisters per case

\$29.68 MGR13600



LIQUID CLEANER WAX & PASTE

MEGUIAR'S

- Clean, polish & protect in one easy step
- Cleans while you wax
- Rich, conditioning oils polish & protect

16 OZ. BOTTLE
MEGUIAR'S

- 6 bottles per case

\$54.40 MGR1216

11 OZ. PASTE
MEGUIAR'S

- 6 containers per case

\$66.96 MGR1214



GOLD CLASS™ CARNAUBA PLUS LIQUID WAX & PASTE

MEGUIAR'S

- Improved formula leaves deeper reflections and a brilliant shine
- Contains premium carnauba and clear coat safe polymers

16 OZ. BOTTLE
MEGUIAR'S

- 6 bottles per case

\$91.60 MGR7016

11 OZ. PASTE
MEGUIAR'S

- 6 containers per case

\$97.12 MGR7014



GOLD CLASS™ RICH LEATHER SPRAY & CLEANING WIPES

MEGUIAR'S

- Protects leather in homes and vehicles with gentle, safe cleaners and rich moisturizers
- Provides UV inhibitors
- Leaves no white residue

15.2 OZ. BOTTLE
MEGUIAR'S

- 6 bottles per case

\$44.16 MGR10916

30 WIPE CANISTER
MEGUIAR'S

- 6 containers per case

\$34.32 MGR10900



MEGUIAR'S® CAR CARE PRODUCTS



HYBRID CERAMIC TIRE SHINE MEGUIAR'S

- 16 oz. bottle - 6 bottles per case
- Adds a brilliant shine and a glossy appearance
- Forms strong bonds to reduce sling, resist water and provide outstanding results

\$39.04 MGR230416



HOT RIMS BLACK WHEEL CLEANER MEGUIAR'S

- 24 oz. bottle - 6 bottles per case
- Formulated for wheels with a black finish
- Foaming gel sticks on the surface and allows for more effective cleaning

\$39.04 MGR230524



HOT SHINE TIRE SPRAY MEGUIAR'S

- 24 oz. bottle - 6 bottles per case
- Blend of premium silicone polymers for a high-gloss wet look shine
- Prevents caking, browning and premature aging

\$45.20 MGR12024



HOT RIMS WHEEL CLEANER MEGUIAR'S

- 24 oz. bottle - 6 bottles per case
- Cleans wheels and tires with new formula
- Moderately aggressive cleaner for use on all factory coated or painted wheels
- Unique foaming action safely dissolves stubborn grime from tires

\$38.72 MGR9524



HOT SHINE TIRE FOAM MEGUIAR'S

- 19 oz. can - 6 cans per case
- Thick, active foam powers through build-up to reveal a deep, black shine
- Conditioners and UV protection help to keep tires looking like new
- Cleans, shines and protects in one easy step with hands-off application

\$37.60 MGR13919



HOT SHINE TIRE COATING MEGUIAR'S

- 15 oz. can - 6 cans per case
- Long-lasting intense shine
- Combines water-resistant polymers, enhanced resin technology, premium silicones and anti-ozonants to protect and keep tires black and shiny longer
- Prevents streaking, cracking, browning and premature aging

\$45.20 MGR13815



NEW CAR SCENT PROTECTANT WIPES & SPRAY MEGUIAR'S

- Shine emulates a new car finish: glossy, but not hi-gloss
- All features & benefits of Natural & Supreme Shine with added "New Car" smell

16 OZ. BOTTLE MEGUIAR'S

- 6 bottles per case

\$30.64 MGR4216

30 WIPE CANISTER MEGUIAR'S

- 6 canisters per case

\$30.16 MGR4200



SUPREME SHINE PROTECTANT MEGUIAR'S

- Non-greasy formula cleans, shines and protects
- Powerful UV blockers and Scotchgard™ Protector to defend against fading, cracking and aging

16 OZ. BOTTLE MEGUIAR'S

- 6 bottles per case

\$36.96 MGR4016

30 WIPE CANISTER MEGUIAR'S

- 6 canisters per case

\$31.60 MGR4000



MEGUIAR'S® CAR CARE PRODUCTS



CARPET & UPHOLSTERY CLEANER

MEGUIAR'S

- 19 oz. - 6 cans per case
- Scrubber brush top
- Deep cleaning, professional strength formula
- Fast acting foam breaks down stains quickly
- Permanent odor eliminating technology
- Leaves behind a fresh, new car scent

\$31.60 MGR191419



CARPET & CLOTH RE-FRESHER

MEGUIAR'S

- 24 oz. - 6 bottles per case
- Instantly removes even the toughest odors - smoke, pet, and more
- Leaves behind a pleasant New Car scent without messy residues or film
- Removes odors through chemical bonding at a molecular level

\$33.04 MGR180724



QUIK SCRATCH ERASER KIT

MEGUIAR'S

- 4 kits per case
- All-in-one kit to remove fine blemishes
- Attaches easily to household drill - the drill works so you don't have to!

\$71.25 MGR190200



3-IN-1 WAX

MEGUIAR'S

- 16 oz. - 4 per case
- Clean, polish, protect
- Gently cleans paint removing minor defects while offering wax protection

\$66.03 MGR191016



HYBRID CERAMIC TRIM RESTORER

MEGUIAR'S

- 16 oz. - 6 bottles per case
- Hybrid Ceramic Technology seals the surface against rain and weather
- Provides a protective layer that makes removing grime easier during washes

\$56.00 MGR220316



HYBRID CERAMIC DETAILER

MEGUIAR'S

- 26 oz. - 6 bottles per case
- Contains the latest advanced Hybrid SiO2 technology
- Gently removes contaminants while adding water beading protection

\$90.56 MGR200526



HYBRID LIQUID CERAMIC WAX

MEGUIAR'S

- 16 oz. - 6 bottles per case
- Contains the latest advanced Hybrid SiO2 technology
- Seals paint while delivering water beading action
- No wax residue

\$111.12 MGR200416



HYBRID CERAMIC WAX

MEGUIAR'S

- 26 oz. - 6 bottles per case
- Just spray on, rinse off & dry!
- No rubbing, curing, buffing or mess
- Durability beyond conventional wax

\$92.24 MGR190526



MEGUIAR'S® CAR CARE PRODUCTS



ULTIMATE SNOW FOAM MEGUIAR'S

- 32 oz. jug - 6 jugs per case
- Intense foam clings & clings
- Lubricates surfaces and serves as a prewash on dirtier vehicles

\$88.00 MGR191532



ULTRA POLISHING WAX MEGUIAR'S

- 1 gallon
- Significant cleaning ability and durable protection in one quick and easy step
- Can be used by hand or with dual action and rotary polishers
- SMAT (Super-Micro Abrasive Technology) cleans quickly while applying a durable blend of synthetic and carnauba protection

\$70.60 MGD16601



BUG & TAR REMOVER MEGUIAR'S

- 15 oz. - 6 can per case
- Aerosol foam won't damage paint
- Rehydrates bugs for easy removal
- Use before or between washes
- Cling foam adheres to vehicle surfaces and deeply penetrates bug and tar residue. It's a perfect pre-treatment before washing, but it may also be used as a standalone treatment in between washes.

\$24.96 MGR180515



ULTIMATE INSANE SHINE PAINT GLOSSER MEGUIAR'S

- 16 oz. - 6 bottles per case
- Enhances gloss, shine, and color of paint
- Conceals light swirls and towel marks
- Safe for glossy paints and clear coats

\$39.04 MGR230316



CITRUS FRESH CLEANING WIPES MEGUIAR'S

- 30 wipes per canister - 6 canisters per case
- Pro-strength formula removes dirt, grease & grime
- For all-purpose interior and exterior cleaning
- Won't stain or bleach trims
- Use on rubber, plastic, vinyl, cloth, and more
- Removes dirt, grease, and grime

\$29.36 MGR190600



NATURAL SHINE PROTECTANT WIPES MEGUIAR'S

- 30 wipes per canister - 6 canisters per case
- Pro-strength formula removes dirt, grease & grime
- Non-greasy formula cleans, shines, and protects while providing superior UV blocking for durable protection
- Quickly restores color and shine to vinyl, rubber and plastic surfaces
- Combines protectant formula with 30 premium large size, non-linting wipes
- Powerful UV blockers and Scotchgard defend against fading, cracking and aging

\$30.16 MGR4100



WHOLE CAR AIR REFRESHER MEGUIAR'S

- 2 oz. can - 6 cans per case
- Chemistry works at the molecular level
- Easy to use mist finds and neutralizes unwanted odors - leaves behind fresh scent
- Reaches air conditioner vents, under seats and all of the cracks and crevices

\$34.00	MGR16402	New Car Scent
\$34.00	MGR16602	Summer Breeze
\$34.00	MGR181302	Black Chrome

LEXOL® CAR CARE

LEXOL PRODUCTS ARE NOT FOR EXPORT



PH BALANCED ALL LEATHER CLEANER

LEXOL



- pH-balanced formula maintains the pH range of leather itself
- Cleans leather, stitching, and other fibers that hold leather together
- Leaves no tacky residue
- Ideal for use on: leather auto upholstery, footwear, furniture, handbags, briefcases, sports equipment, and luggage
- Contains no waxes, oils, or additives that interfere with its cleaning capabilities

\$20.40	LEX1108	8 oz	6 Per Case
\$37.20	LEX4027	16.9 oz	6 Per Case
\$128.80	LEX1112	1 Liter	12 Per Case



PH BALANCED LEATHER CONDITIONER

LEXOL



- Liquid base which allows the product to penetrate the surface into leather pores, for deep conditioning that prevents cracking and premature aging.
- Ideal for use on: leather auto upholstery, footwear, furniture, handbags & briefcases, sports equipment and luggage
- Leaves no greasy residue

\$20.40	LEX1008	8 oz	6 Per Case
\$37.20	LEX4028	16.9 oz	6 Per Case
\$76.75	LEX1014	3 Liter	4 Per Case



LEATHER QUICK CARE WIPES

LEXOL



- 28 wipes per canister | 6 canisters per case
- One-step formula cleans, conditions, preserves and protects leather on-the-go
- Ultra-gentle, free of waxes and oil
- UV filter helps prevent cracking, aging and fading
- Contains neatsfoot leather conditioning oil
- Maintains leather's original color

\$23.28	LEX0028
----------------	----------------

SPRAYWAY® RETAIL PRODUCTS



Sprayway offers a complete line of vehicle care products for auto detailing and maintenance professionals, car washes, retailers, OEMs and consumers.



SPRAYWAY CANS

SPRAYWAY RETAIL

\$92.46	SWG936	INSTANT SHINE	12/Case	11 oz.	Great for use on vinyl, moldings & engine compartments. VOC compliant, silicone based
\$93.15	SWG780	INTERIOR DETAILER	12/Case	12 oz.	Quick drying, fresh scent, greaseless, streakless, matte finish, VOC compliant
\$45.71	SWG19	GLASS CLEANER	12/Case	19 oz.	Ammonia-free formula uses denatured alcohol to leave a streak-free finish on glass surfaces

MOTHERS® CAR CARE & TREATMENTS

MOTHERS®
Polishes•Waxes•Cleaners



NULENS HEADLIGHT RENEWAL KIT

MOTHERS

- 6 Kits Per Case
- Cleans away yellowing and stains, and buffs hairline scratches, smudges, and flaws in a single step
- Included PowerPlastic 4Lights® polish restores crystal clarity, leaving a tough protective, oxidation-inhibiting polymer layer

INCLUDES:

- 3" Backing Plate & Restoration Discs
- 8 oz. Polish
- PowerBall 4Lights Polishing Tool

\$131.05 MD07251



ULTIMATE MAG & ALUMINUM POLISH

MOTHERS RETAIL PRODUCTS

- 5 oz. container - 6 containers per case
- Meticulously cleans, restores and protects any metal surface to next level, high-gloss shine and brilliance using ultra-fine, SiO2 infused nano-quartz abrasives. Safe for any uncoated metal, including aluminum, billet, stainless steel, nickel, brass, silver and copper. Incredible results when used by hand, or with any of the metal polishing tools from the Mothers PowerBall® line.
- Ideal for billet and high end polishable metals, leaves a next level, high-gloss shine
- Restores and protects
- Use with microfiber for best results

\$100.98 MD05120



LEATHER CLEANER

MOTHERS RETAIL PRODUCTS

- 12 oz. bottle - 6 bottles per case
- pH balanced formula safely lifts ground in dirt, grime and stains from your leather interior
- Prepares the leather for Mothers leather conditioner, which ensures a long, supple life

\$36.98 MD06412



LEATHER CONDITIONER

MOTHERS RETAIL PRODUCTS

- 12 oz. bottle - 6 bottles per case
- Lanolin and neatsfoot oil preserves natural oils lost with age. It leaves a protective barrier that helps seal out the detrimental effects of the sun, time, and daily abuse.

\$43.65 MD06312



CARPET & UPHOLSTERY CLEANER

MOTHERS RETAIL PRODUCTS

- 24 oz. bottle - 6 bottles per case
- Tough enough for stubborn stains and marks that mar your vinyl, velour, cloth, carpet, and sheepskin, while being pH balanced and environmentally safe.

\$40.33 MD05424



FOAMING WHEEL & TIRE CLEANER

MOTHERS RETAIL PRODUCTS

- 24 oz. bottle - 6 bottles per case
- Spray on, hose off design safely penetrates, dissolves and suspends all types of brake dust, grease, dirt, and grime, making rinsing a snap.

\$46.19 MD05924



PRO STRENGTH CHROME WHEEL CLEANER

MOTHERS RETAIL PRODUCTS

- 24 oz. bottle - 6 bottles per case
- Works on chrome wire wheels, chrome bumpers, and roughcast aluminum. Safely penetrates and dissolves and suspends all types of dirt and grime.

\$46.19 MD05824



PROTECTANT

MOTHERS RETAIL PRODUCTS

- 16 oz. bottle - 6 bottles per case
- A penetrating UV blocker, effective on rubber, vinyl, plastic, and fiberglass. For use on dashboards, bumpers, trim, tires and more.

\$47.05 MD05316



CALIFORNIA GOLD® CHROME POLISH
MOTHERS RETAIL PRODUCTS

- 12 oz. - 6 bottles per case
- Use on your wheels, bumpers, mirrors, headlight bezels, and chrome accessories.

\$30.23 MD05212



CALIFORNIA GOLD® INSTANT DETAILER
MOTHERS RETAIL PRODUCTS

- 16 oz. - 6 bottles per case
- Unique formula will clean off fingerprints, smudges and dust, and hide minor imperfections and spider-webbing.

\$36.92 MD08216



CALIFORNIA GOLD® ALL CHROME
MOTHERS RETAIL PRODUCTS

- 12 oz. - 6 bottles per case
- Removes fingerprints, smudges, dust, bugs, and even light water spots, leaving behind a protective barrier to keep your chrome sparkling.

\$30.25 MD05222



CALIFORNIA GOLD® BRAZILIAN CARNAUBA CLEANER WAX
MOTHERS RETAIL PRODUCTS

- One-step plan for paint preservation. Cleaner Wax is formulated to clean and protect in just one application. We use the same Brazilian #1 yellow carnauba that makes our Pure Carnauba Wax so special, and combined it with a light polish that will smooth minor flaws and make your paint snap. Brazilian Carnauba Cleaner Wax is especially effective on fiberglass and gel coats.
- Available in liquid or paste

\$47.08	MD05701	16 oz. Liquid	6 Per Case
\$67.22	MD05500	12 oz. Paste	



CALIFORNIA GOLD® CLAY BAR SYSTEM
MOTHERS RETAIL PRODUCTS

- 3 clay bars per pack | 6 packs per case
- Removes embedded grains of metal, tree sap, airborne environmental deposits, and paint overspray. Not hazardous to car paint; it's just firm enough to pick up contaminants without being too aggressive. Plus, it paves the way for complete waxing!

\$118.28 MD07240



CALIFORNIA GOLD® 3 CLAY BARS
MOTHERS RETAIL PRODUCTS

- 3 clay bars per pack | 6 packs per case
- Created to remove the particulate debris and contaminants that washing and polishing can't, clay bar will remove embedded grains of metal, tree sap, airborne environmental deposits and paint overspray. Gets rid of paint-fouling grime and pave the way for polishing, waxing or coating.
- Perfect for the frequent user who doesn't need the lubricant and towel.

\$89.78 MD07242



CALIFORNIA GOLD® WATERLESS WASH & WAX
MOTHERS RETAIL PRODUCTS

- 24 oz. bottle - 6 bottles per case
- Unique formula that allows you to both wash and wax vehicles surfaces without using any water.
- Excellent for areas with water restrictions or isolated spots where it's difficult for water hoses to reach.
- Acts as a cleaner that dissolves dirt and road grime, as well as a finishing product.
- Simply spray, wipe, and buff the vehicle surface to leave a clean, scratch-free, shiny waxed finish.

\$43.69 MD05644



CALIFORNIA GOLD® SPRAY WAX
MOTHERS RETAIL PRODUCTS

- 24 oz. - 6 bottles per case
- Quick and easy way to clean, shine, and protect any automotive paint, including clear coat. It safely removes surface dust and fingerprints, while adding long-lasting shine, luster, and depth.
- Cleans and protects
- Provides that just-waxed look
- For wet or dry surfaces

\$47.05 MD05724

MOTHERS® SPEED™ LINE & REVISION™

MOTHERS
Polishes • Waxes • Cleaners



BUG & TAR REMOVER MOTHERS SPEED PRODUCTS

- 18.5 oz. - 6 cans per case
- A fast-acting, professional spray that effectively neutralizes acidic bug guts, bird droppings, and other unsavory foreign contaminants on contact!
- Ideal for road grime, tar, sap, and other organic matter.
- Use on paint, chrome, glass, metal, plastic, acrylic, vinyl wrap, and clear paint surfaces.
- No-drip foam works well on hard-to-reach areas like grills, vents, louvers, and other detailing spots!

\$33.61 MD16719



FOAMING GLASS & SCREEN CLEANER MOTHERS SPEED PRODUCTS

- 19 oz. - 6 cans per case
- Foaming mist won't drip or run, cuts through grime, dirt, oily film and fingerprints, leaving only a streak-free shine
- Ammonia-free formula is safe for a variety of applications including window tint, phones, gauges and more!

\$29.52 MD16619



TIRE SHINE MOTHERS SPEED PRODUCTS

- 15 oz. - 6 cans per case
- Durable, penetrating mist coats your tire for maximum shine & superior protection.
- Micro-emulsion resin technology combines with premium silicones to give your tires a finish that won't brown, sling or run.

\$40.33 MD16915



CLAY 2.0 TOOL MOTHERS SPEED PRODUCTS

- **SOLD INDIVIDUALLY**
- Patented, rubber polymer technology quickly shears off and removes both surface and embedded contaminants including paint overspray, water spots, fresh tree sap, rail dust, bird droppings, light oxidation and brake dust.

\$21.12 MD17240



SPRAY WAX MOTHERS SPEED PRODUCTS

- 24 oz. - 6 bottles per case
- Tackling everything from light dust and pollen to greasy fingerprints and road grime.
- No white residue
- Works as a booster over your existing wax, or as a stand-alone product, and can even be used to wax as you dry your car.

\$48.99 MD15724



INTERIOR DETAILER SPRAY MOTHERS SPEED PRODUCTS

- 24 oz. - 6 bottles per case
- Ammonia-free formula uses micro-emulsifying agents and biodegradable surfactants to quickly dissolve dirt, oily film and fingerprints, leaving your interior surfaces clean and protected, without greasy residue or streaks.

\$33.58 MD18324



ALL-PURPOSE CLEANER SPRAY MOTHERS SPEED PRODUCTS

- 24 oz. - 6 bottles per case
- Powerful enough for the grasiest of jobs, even under the hood
- Carefully crafted blend of nonionic surfactants and highly effective cleaners are gentle enough to dissolve oils and tough stains embedded in your delicate carpet and upholstery

\$30.26 MD18924



REVISION™ GLASS + SURFACE MOTHERS RETAIL PRODUCTS

- 24 oz. - 6 bottles per case
- Quickly removes tough grime, dirt, oily film and fingerprints from virtually any surface, leaving behind a sparkling clean, streak-free shine.
- Pro-strength ammonia-free formula effectively cleans glass, mirrors, plastic and chrome, yet it's safe for delicate window tint, gauges, GPS screens, smart phones, tablets, touchscreens, and other displays.
- Great for home use on windows, countertops, appliances, TVs and monitors.

\$35.24 MD06624

MOTHERS® ULTIMATE HYBRID™



ULTIMATE HYBRID™ LINE

MOTHERS

- Mothers Ultimate Hybrid™ brings you the best of SiO2 ceramic and carnauba wax in a product line tailored to eliminate learning curves and application curveballs, allowing you to care for your vehicle as you always have. It's that easy.

PRICE	PART #	PRODUCT	SIZE	PER CASE
\$90.68	MD05566	Ceramic Wax	16 oz.	6
\$60.45	MD05764	Ceramic Spray Wax	24 oz.	
\$57.09	MD08264	Ceramic Detailer	24 oz.	

MOTHERS® CMX®

CMX® CERAMIC LINE

MOTHERS

- Mothers CMX line of ceramic washes, preps, polishes and protects.
- Mothers CMX products are affordable, user-friendly, professional grade, ultra-durable, super-hydrophobic protection formulas. Coating and caring for your vehicle has never been easier. Join the revolution!

PRICE	PART #	PRODUCT	SIZE	PER CASE
\$87.32	MD01024	Ceramic Spray Coating	24 oz.	6
\$60.45	MD01224	Ceramic Surface Prep	24 oz.	
\$80.60	MD01548	Ceramic Wash & Coat	48 oz.	
\$67.17	MD01300	Ceramic Trim Restore & Coat	6.7 oz.	

MOTHERS® BACK-TO-BLACK®

BACK-TO-BLACK® RESTORER

MOTHERS RETAIL

10 OZ. AEROSOL

MOTHERS RETAIL

- 6 per case
- Simple mist-on and walk away dressing provides unmatched results and convenient, effortless application. Removes light oxidation, wax residue and surface film
- Instantly brings back that dark, factory-new sheen to any sun-burnt plastic, rubber or vinyl
- Provides a long lasting, protective barrier, preventing further deterioration caused by sun, smog, ozone, water, chemicals and airborne contaminants

\$50.37 MD06110

BACK-TO-BLACK® HEAVY DUTY TRIM CLEANER KIT

MOTHERS RETAIL

- 12 oz. bottle - 6 kits per case
- Provides unmatched cleaning ability, restoring exterior trim and textured plastics to their original, like-new color
- Deep cleans, erases years of neglect and environmental abuse, including oxidation, dirt, road grime, even stubborn embedded wax

\$43.66 MD06141

12 OZ. LIQUID

MOTHERS RETAIL

- 6 per case
- Remove light oxidation, dirt, wax residue and surface film with ease, bringing back that like-new color and protecting against further deterioration caused by sun, smog, ozone, water, chemicals and airborne contaminants.

\$47.02 MD06112

BACK-TO-BLACK® TIRE SHINE

MOTHERS RETAIL

- 24 oz. bottle - 6 bottles per case
- Provides a long-lasting resistant protective coating

\$57.07 MD06924





STONER INTERIOR CLEANING PRODUCTS



TRIM CLEAN
FOAMING CLEANER

• 18 oz. - 6 per case

\$30.70 STN1134



VINYL & PLASTIC
SHINE COATING

• 9 oz. - 12 per case

\$61.71 STN053



UPHOLSTERY
CARPET CLEANER

• 18 oz. - 12 per case

\$56.42 STN144



LEATHER
CLEANER & CONDITIONER

• 16 oz. - 6 per case

\$34.29 STN5400



XENIT™
CLEANER & REMOVER

• 10 oz. - 12 per case

\$77.77 STN213

STONER EXTERIOR CLEANING PRODUCTS



SPEED BEAD®
QUICK DETAILER

• 22 oz. - 6 per case

\$36.19 STN2354



TIRE FINISH
AEROSOL

• 12 oz. - 6 per case

\$46.60 STN094



TIRE FINISH
TRIGGER

• 22 oz. - 6 per case

\$46.60 STN244



TAR & SAP
REMOVER

• 10 oz. - 12 per case

\$71.38 STN153



BUG ERASER
REMOVER

• 10 wipes per box - 6 boxes per case

\$30.31 STN5401



HYBRID CERAMIC
CLEANER AND REPELLENT
INVISIBLE GLASS

• 16 oz. - 6 per case

\$89.94 STN92183



HYBRID CERAMIC
DETAILER
CLEANER & REMOVER

• 16 oz. - 6 per case

\$89.94 STN92303



HYBRID CERAMIC
TRIM SHINE
CLEANER & CONDITIONER

• 16 oz. - 6 per case

\$89.94 STN92333



STONER GLASS CARE & MORE

STONER INVISIBLE GLASS® PRODUCTS

STONER RETAIL PRODUCTS

- Premium, streak-free, tint safe, glass cleaner - Makes glass so clean and clear it virtually disappears
- Powerful ClearDry formula removes dust, dirt, pet slobber, oily residue and fingerprints



AEROSOL STONER INVISIBLE GLASS

- 19 oz. - 12 per case

\$45.82 STN164



TRIGGER SPRAY STONER INVISIBLE GLASS

- 22 oz. - 6 per case

\$27.35 STN184



GLASS WIPES STONER INVISIBLE GLASS

- 28 wipes per canister - 6 canisters per case

\$22.91 STN064



ANTI-FOG STONER INVISIBLE GLASS

- 8 oz. - 6 bottles per case
- Improve visibility and drive safer!

\$27.86 STN2472



GLASS STRIPPER STONER INVISIBLE GLASS

- 3.38 oz. bottle and one applicator per kit - 6 kits per case

\$41.38 STN1411



RAIN REPELLENT STONER INVISIBLE GLASS

- 8 oz. - 6 bottles per case
- Prevents water sheeting in even the heaviest of downpours
- Makes bugs, bird droppings, salt, ice, and frost easier to remove

\$32.32 STN2482



STONER TRIM SHINE® STONER RETAIL PRODUCTS

- The professional's protectant lasts for weeks
- Makes dull and faded automotive trim look like new! Great for vinyl, plastic & rubber.

AEROSOL STONER TRIM SHINE

- 12 oz. - 12 per case

\$75.61 STN033

TRIGGER SPRAY STONER TRIM SHINE

- 22 oz. - 6 per case

\$37.79 STN2034



CLEAN & REPEL AEROSOL STONER INVISIBLE GLASS

- 19 oz. - 6 cans per case

\$27.35 STN1184



<https://invisibleglass.com/collections/automotive/products>



VEHICLE FLOOR MATS



GLASS CLEANER

SIMONIZ

- 19 oz. can - 12 cans per case
- Foam clings to vertical surfaces and traps dirt
- Spray on and wipe off
- No rinsing required
- No-ammonia formula

\$38.18 JS3321012



INSTANT SPRAY

SIMONIZ

- 20 oz. can - 12 cans per case
- Spray on and wipe off or leave to air dry
- Great for tight spots like air vents

\$103.09 JS3327012



GRAFFITI REMOVER

SIMONIZ

- 18 oz. can - 12 cans per case
- Spray on, wipe off
- Removes spray paint, ink, crayon, and more
- Use on steel, brick, tile, marble, chrome, brass, aluminum, porcelain, glass, Formica, enamel, and more

\$68.18 JS3346012



CITRUS CLEAN

SIMONIZ

- 20 oz. can - 12 cans per case
- Use on multiple surfaces including carpet
- Interior and exterior cleaning
- Spray on and wipe off
- Great citrus scent
- No butyl or petroleum solvents

\$51.81 JS3376012



ADHESIVE REMOVER

SIMONIZ

- 20 oz. can - 12 cans per case
- Removes adhesive residue from a multitude of automotive surfaces
- Great for getting rid of bumper stickers
- Aerosol spray

\$132.86 JS3365012

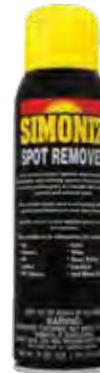

SPOT REMOVER

SIMONIZ

- 20 oz. can - 12 cans per case
- For use on all kinds of stains
- Great on carpet and floor mats
- Simply spray on, agitate, and wipe away

\$71.19 JS3364012



CARPET & UPHOLSTERY

SIMONIZ

- 20 oz. can - 12 cans per case
- Excellent for auto detailing, home use, and professional office cleaning

\$62.05 JS3363012

VEHICLE FLOOR MATS



HEAVY DUTY FLOOR MAT SET

SIMONIZ

- 4 mats per pack | 1 left, 1 right, and 2 back seat utility mats
- Heavy-duty rubber construction
- Stain-resistant design
- Anti-slip nib backing
- Universal fit
- Diamond plate texture for traction

\$10.90 FM00209



CARPET FLOOR MAT SET WITH VINYL HEEL PAD

SIMONIZ

- 4 mats per pack | 1 left, 1 right, and 2 back seat utility mats
- Durable construction
- Stain-resistant design
- Anti-slip nib backing
- Universal fit - easy installation

\$7.05	FM00216	Black
\$7.05	FM00217	Gray
\$7.05	FM00218	Tan



VINYL FLOOR MAT SET

SIMONIZ

- 4 mats per pack | 1 left, 1 right, and 2 back seat utility mats
- Durable textured vinyl construction
- Stain-resistant design
- Anti-slip nib backing
- Universal fit - easy installation

\$4.49	FM00219	Black
\$4.49	FM00220	Gray
\$4.49	FM00221	Tan
\$5.77	FM00222	Clear



CARPET FLOOR MAT WITH VINYL HEEL PAD

SIMONIZ

- 4 mats per pack | 1 left, 1 right, and 2 back seat utility mats
- Durable carpet construction
- Stain-resistant design
- Anti-slip nib backing
- Universal fit - easy installation

\$7.05	FM00223	Black
\$7.05	FM00224	Gray
\$7.05	FM00225	Tan



DEEP DISH FLOOR MAT SET

SIMONIZ

- 4 mats per pack | 2 front and 2 rear
- Deep channels
- Durable PVC material
- All-weather endurance
- Universal design fits most cars, trucks, and SUV's
- Front mats measure 30" x 20.5"
- Rear mats measure 20" x 20.5"

\$12.76 FM01067 Diamond Plate



VP RACING FLOOR MAT

SIMONIZ

- 4 mats per pack | 1 left, 1 right, and 2 back seat utility mats
- Heavy-duty construction
- Stain-resistant design
- Anti-slip nib backing
- Universal fit

\$12.76 FM01559



VEHICLE FLOOR MATS



MARVEL DEADPOOL MAT SET

PLASTICOLOR

- Your customers will love getting to show off their favorite Marvel characters with PlastiColor's superhero floor mat line! This PlastiClear Deadpool Repeater set includes two mats made of durable PVC layers. Each mat is printed with Deadpool's image front and center, in brilliant red and black tones!
- 2 mats per pack | Standard size fits most
- Surface: PVC clear film 10%
Printed mid layer: white PVC film 10%
Injected backing: black PVC 80%

\$31.30 FM01591



MARVEL PUNISHER MAT SET

PLASTICOLOR

- Your customers will love getting to show off their favorite Marvel characters with PlastiColor's superhero floor mat line! The Punisher set includes two mats made of durable, textured PVC. Each mat features a bold white Punisher skull and sleek grey stripes - the perfect compliment to any fan's vehicle!
- 2 mats per pack
Standard size fits most cars and trucks
100% PVC construction

\$29.54 FM01486



MARVEL CAPTAIN AMERICA MAT SET

PLASTICOLOR

- Your customers will love getting to show off their favorite Marvel characters with PlastiColor's superhero floor mat line! This Captain America set includes two mats made of durable PVC layers. Each mat is printed with the Captain's shield as well as scenes from a comic book battle.
- 2 mats per pack | Standard size fits most
- Surface: PVC clear film 10%
Printed mid layer: white PVC film 10%
Injected backing: black PVC 80%

\$31.30 FM01590



VEHICLE ACCESSORIES



DIAMOND PLATE STYLE RUBBER SEMI TRUCK MUD FLAP

DENCO

- A set of rubber mud flaps designed to endure the harshest road conditions and meet NTSB safety requirements
- Measures 24" wide x 30" long
- Features slotted holes for fast and easy installation
- Sold as a pair

\$47.07 DT2430D



CHEVRON STYLE RUBBER SEMI TRUCK MUD FLAP

DENCO

- A set of rubber mud flaps designed to endure the harshest road conditions and meet NTSB safety requirements
- Measures 24" wide x 30" long
- Features slotted holes for fast and easy installation
- Sold as a pair

\$45.64 DD2430C

CERAMIC COATINGS, WHEEL CARE & INTERIOR DETAILING



DIAMOND PLATE KIT

SIMONIZ

- Nano ceramic polymer coating that reacts with a vehicle's clear coat finish to form a second layer and thicker coating for added protection. Weather-resistant, provides UV protection, wear and acid rain resistance.
- Protects against: acid rain, bird droppings, insects, hard water spots, sun and UV damage resulting in: fading, chalking & loss of gloss.

1 KIT INCLUDES:

- 1 vial of the patent pending Diamond Plate
- VisionBlade hydrophobic windshield protector
- Microfiber finishing towel
- The Diamond Plate warranty
- P.O.S. customer hand outs
- Applicator
- Gloves

CALL FOR PRICING

DPKIT

ORIGINAL CAN PASTE

SIMONIZ



- 7 oz. container of 100% Pure Brazilian carnauba wax - the hardest natural wax known to man
- Provides the longest-lasting shine and durability in the paste wax market. Keeps auto finish looking brand new and protected
- Work in the shade or inside and make sure your vehicle's surface is completely dry and cool to the touch
- Thoroughly wash your vehicle. Simoniz Wash N' Shine car soap is a great choice
- Apply a thin layer of wax to a clean wax applicator pad. Working in small sections of the vehicle, apply the wax with light pressure in straight line motions making sure to cover the area completely
- Wait until the wax completely hazes and buff it out with a clean microfiber towel to reveal a brilliant shine

\$13.86

DTS28695

New!



NU FINISH SEALANT

NU FINISH

- 16 oz - 12 per case
- Remove scratches and swirls
- Features a 3-in-1 formula that is infused with ceramic to provide superior paint protection
- All you need is two microfiber towels, one damp, one dry, and a bottle of Once A Year

\$86.34

AR39866

ARMORALL PROTECTANT

ARMOR ALL



- Great for use on dashboards, vinyl seats, doors, panels, consoles, tires, trims, and bumpers. It is not designed for use on floors, vehicle controls (pedals, grips, steering wheels), bench or cycle seats, cycle tires, or brake drums. Do not use on or near clear plastic surfaces or glass, as the product may cause smearing.
- Fights aging, fading, and cracking
- Enhances your vehicle's deep, rich look
- Helps renew and revitalize vinyl, rubber, and plastic
- Provides UV protection
- Adds a beautiful shine

\$15.47	AR10644	64 oz.	4 per case
\$30.38	AR10710	1 gallon	4 per case
\$327.33	AR10820	20 gallons	
\$781.22	AR10855	55 gallons	

KLEEN-RITE DETAILING CHEMICALS

KLEEN-SHINE™ PROFESSIONAL CAR DETAILING CHEMICALS

DETAIL CHEMICALS

- Kleen-Shine detail chemicals and polishes by Kleen-Rite are specifically formulated to deliver outstanding results and labor savings to car detailing operations. The extensive line of Kleen-Shine products for express detailing and full-service detailing are designed to work quickly, safely and effectively. Our high-quality, cost-effective formulations deliver superior results faster, without wasting time or leaving harmful residue. Kleen-Shine detailing products are designed to boost your detailing business by helping you create satisfied repeat customers at a higher profit!



FINAL MIST FINAL DETAIL ENHANCER

KLEEN-SHINE

- Spray & wipe, leaves a deep high shine, cleans away dust & light soil

\$11.34	KS1094	1 Gallon
\$50.87	KS5094	5 Gallon
\$1.44	TBD1094	Spray Bottle Label



POWER BUSTER CONCENTRATED DEGREASER

KLEEN-SHINE

- Fast-acting engine & undercarriage degreaser, safe on most surfaces, non-corrosive

\$12.89	KS1116	1 Gallon
\$58.60	KS5116	5 Gallon
\$504.41	KS55116	55 Gallon



TOP FOAM CAR WASH DETERGENT

KLEEN-SHINE

- High foaming, excellent lubricity, highly concentrated

\$7.88	KS1004	1 Gallon
\$37.55	KS5004	5 Gallon



GLASS KLEEN CONCENTRATE

KLEEN-SHINE

- Cleans without streaking, ammonia-free formula, pleasant fragrance

\$13.42	KS1084	1 Gallon
\$62.16	KS5084	5 Gallon
\$1.44	TBD1084	Spray Bottle Label



BUG B GONE

KLEEN-SHINE

- Quickly softens tough insect residue, safe on painted surfaces, concentrated

\$14.70	KS1085	1 Gallon
\$73.52	KS5085	5 Gallon
\$1.44	TBD1085	Spray Bottle Label



KLEEN & QUICK ALL PURPOSE CLEANER

KLEEN-SHINE

- Quickly removes dirt & grease, pleasantly scented, free-rinsing. Great for upholstery, vinyl, tires, & engines.

\$7.54	KS1086	1 Gallon
\$45.74	KS5086	5 Gallon
\$465.27	KS5586	55 Gallon
\$1.44	TBD1086	Spray Bottle Label



CONTAINS BUTYL



SPRAY BOTTLE LABELS AVAILABLE FOR MOST KLEEN-SHINE PRODUCTS

CHECK BELOW EACH PRODUCT FOR THE CORRESPONDING LABEL PART NUMBER. BOTTLES, TRIGGERS, SPRAYERS & LABELS ARE SOLD SEPARATELY!



KLEEN WHITE WHITEWALL CLEANER

KLEEN-SHINE

- Quickly brightens whitewalls, safe on painted surfaces, rinses film-free

\$5.93	KS1044	1 Gallon
\$1.44	TBD1044	Spray Bottle Label



WHEEL KLEEN WHEEL BRIGHTENER

KLEEN-SHINE

- Leaves wheels sparkling clean, pleasant fragrance, removes heavy soil and grime

\$12.97	KS1113	1 Gallon
\$49.20	KS5113	5 Gallon
\$1.44	TBD1113	Spray Bottle Label



*** MUST SHIP FREIGHT**



ALL KLEEN ALL PURPOSE CLEANER

KLEEN-SHINE

- Quickly removes dirt & grease. Fresh, pleasant scent, free rinsing

\$11.34	KS1091	1 Gallon
\$41.73	KS5091	5 Gallon
\$1.44	TBD1091	Spray Bottle Label



CONTAINS BUTYL



PRE-SPRAY CARPET & UPHOLSTERY SPOTTER

KLEEN-SHINE

- Suspends heavy soils, loosens tough spots & stains, increases effectiveness

\$15.63	KS1121	1 Gallon
\$61.62	KS5121	5 Gallon
\$1.44	TBD1121	Spray Bottle Label



FABRIC KLEEN UPHOLSTERY CLEANER

KLEEN-SHINE

- Quickly removes dirt & grime, high foaming formula leaves fabric soft!

\$10.27	KS1093	1 Gallon
\$44.96	KS5093	5 Gallon
\$1.44	TBD1093	Spray Bottle Label



EXTRACTOR KLEEN CARPET & UPHOLSTERY CLEANER

KLEEN-SHINE

- Low foaming formula, removes tough soil & grime, leaves no soapy residue

\$13.18	KS1115	1 Gallon
\$47.22	KS5115	5 Gallon



KLEEN-RITE DETAILING CHEMICALS



DEFOAMER EXTRACTOR ADDITIVE KLEEN-SHINE

- Kills foam in extractor recovery tank, protecting the extractor motor from damage

\$12.79	KS1118	1 Gallon
----------------	---------------	----------



FRESH N KLEEN EXTRACTOR DEODORIZER KLEEN-SHINE

- Cleans as it freshens, powerful deodorants eliminate odors, highly concentrated

\$24.26	KS1265	1 Gallon
----------------	---------------	----------



INTERIOR DRESSING VINYL & LEATHER CONDITIONER KLEEN-SHINE

- Cleans away light soils, produces a satin shine, leaves a pleasant fragrance

\$27.00	KS1096	1 Gallon
\$99.67	KS5096	5 Gallon
\$534.19	KS30096	30 Gallon
\$1.44	TBD1096	Spray Bottle Label



WATER BASED



TIRE SHINE EXTERIOR DRESSING KLEEN-SHINE

- Easy to apply, leaves a durable satin shine

\$25.22	KS1099	1 Gallon
\$117.14	KS5099	5 Gallon
\$962.37	KS55099	55 Gallon
\$1.44	TBD1099	Spray Bottle Label



TIRE & TRIM DRESSING KLEEN-SHINE

- High gloss shine, easy to apply, and water-resistant

\$16.84	KS1107	1 Gallon
\$75.69	KS5107	5 Gallon
\$1.44	TBD1107	Spray Bottle Label



WATER BASED



PAD GLAZE SWIRL REMOVER KLEEN-SHINE

- Removes swirl marks, silicone-free, body shop friendly, buffs to high shine

\$19.76	KS1653	1 Gallon
----------------	---------------	----------



SPEEDY GLOSS EXPRESS POLISH KLEEN-SHINE

- Easy to apply, cleans away road film, buffs quickly to a high shine

\$23.37	KS1649	1 Gallon
\$1.44	TBD1649	Spray Bottle Label



DURA SHINE SEALANT KLEEN-SHINE

- Provides a durable polymer coating, easy to apply, enhances gloss

\$20.41	KS1652	1 Gallon
----------------	---------------	----------



KLEEN-RITE DETAILING CHEMICALS



ONE STEP HIGH SHINE CLEANER POLISH

KLEEN-SHINE



- Removes scratches & blemishes, great for rotary buffer & orbital polishers

\$22.28	KS1654	1 Gallon
\$1.44	TBD1654	Spray Bottle Label



EASY CUT COMPOUND

KLEEN-SHINE



- Quickly removes heavy scratches, silicone-free, buffs to a high shine

\$28.80	KS1655	1 Gallon
----------------	---------------	----------



KLEEN-SHINE PRODUCTS

KLEEN-SHINE



The following products are available in 5-gallon pails

\$50.87	KS5094	Final Mist Detail Enhancer	\$75.69	KS5107	Tire Dressing Water based
\$41.73	KS5091	Kleen-Shine All Purpose Cleaner	\$117.14	KS5099	Tire Shine Exterior Dressing
\$47.22	KS5115	Extractor Kleen Carpet Cleaner	\$37.55	KS5004	Top Foam Carwash Detergent
\$44.96	KS5093	Fabric Kleen Upholstery	\$49.20	KS5113	Wheel Kleen Sterling
\$62.16	KS5084	Glass Kleen Concentrate	\$73.52	KS5085	Bug B Gone Insect Remover
\$99.67	KS5096	Interior Dressing Vinyl & Leather	\$58.60	KS5116	Power Buster Degreaser
\$61.62	KS5121	Pre-Spray Carpet Spotter			



KLEEN-RITE SANITIZING KIT | DISINFECTANTS/SANITIZERS



INTERIOR VEHICLE SANITIZING KIT

KLEEN-RITE



Provide your customers with a new service, and help them be confident in the level of cleanliness in their vehicle! Ready to go right out of the box, this kit will help you sanitize and disinfect the interiors of customer vehicles, as a courtesy or as an additional service.

The Dema 900.5LSU Foam Spray Unit is a super-compact chemical sprayer with a manual hand pump. This model is perfect for smaller jobs and spot cleaning in tight spaces.

Simoniz Proselect RTU Interior Car Surface Disinfectant, Sanitizer and Deodorizer sanitizes and disinfects against many of the leading bacteria, viruses, and fungus found in vehicles. Formulation has been designed and tested for use on soft vehicle surfaces including upholstery, fabric, and seat cushions, as well as household surfaces including couches and blankets. Appropriate for hard, nonporous vehicle surfaces including dashboards, steering wheels, windows, doors, instrument panels, consoles, seat belt buckles, and almost any metal, stainless steel, or plastic surface.

INCLUDES:

- 1 Dema 900.5LSU Pump Spray Unit • 1 Case (12 quarts) Simoniz RTU Interior Sanitizer

\$135.32	KRK9000
-----------------	----------------

PROSELECT RTU CAR SURFACE SANITIZER & DISINFECTANT

SIMONIZ



- Sanitizer and disinfectant for both hard and soft vehicle interior surfaces (including upholstery, fabric, seat cushions, couches, blankets, steering wheels, windows, and more)
- EPA-registered product qualified for use against SARS-CoV-2, the novel coronavirus that causes COVID-19. This cleaner is expected to be effective at preventing the spread of coronavirus. Please allow 10 minutes of contact time on surfaces.

\$112.32	PA5537	5 Gallons
\$47.64	JS202600	1 Quart - 12 quarts per Case



RTU ANTIMICROBIAL ALL-PURPOSE DISINFECTANT CLEANER

SIMONIZ



- Quaternary-based nonacid cleaner and disinfectant, this cleaner can be used on the following nonporous, inanimate surfaces (walls, tables, shower stalls, bathroom tile, toilet bowls, counter tops, sinks, and more.)
- EPA-registered product qualified for use against SARS-CoV-2, the novel coronavirus that causes COVID-19. This cleaner is expected to be effective at preventing the spread of coronavirus. Please allow 10 minutes of contact time on surfaces.

\$15.75	JS2635	1 Gallon
\$50.54	JS2635-12	1 Quart - 12 quarts per Case





SIMONIZ® DETAILING CHEMICALS



STRAWBERRY EXPRESS WAX SIMONIZ

- Blend of synthetic polymers for ease of use
- Pure carnauba for excellent durability
- Strawberry scented
- Easily applied and removed - no residue left behind

\$44.58 JS3287-S 1 Gallon



BANANA EXPRESS WAX SIMONIZ

- Blend of synthetic polymers for ease of use
- Pure carnauba for excellent durability
- Banana scented
- Easily applied and removed - no residue left behind

\$44.58 JS3287-B 1 Gallon



CORRECTION CREME SIMONIZ

- Easy-to-use light cut compound and polish
- Removed light oxidation and swirl marks
- Unique product can be used as a one-step, quick hazing cleaner wax or as a light compound in a buffing process

\$29.73 JS3276 1 Gallon



NU SHINE SIMONIZ

- Easy to use cleaner/polish - great for use on dark automotive finishes
- Use as an express wax or in full restoration projects
- Offers high gloss and exceptional durability

\$32.45 JS3323 1 Gallon



SHINE PLUS SIMONIZ

- Revitalize and renourish rubber and vinyl surfaces
- Ready-to-use and can be applied to interior and exterior surfaces
- Leaves a great shine
- Rubber and vinyl look like new

\$29.25 JS3325 1 Gallon



LEATHER CLEANER & CONDITIONER SIMONIZ

- Cleans, restores and protects leather
- Brings back soft, supple natural feel of leather in seconds without leaving a greasy look
- Safe for all colors and types

\$28.72 JS3289 1 Gallon



For as long as automobiles have been a favorite American pastime, Simoniz® has helped to keep cars looking their best. Simoniz offers a wide variety of innovative products and services that enhance both the experience and the finishing shine.



SYNTHETIC SEALER SIMONIZ

- Doubles as paint sealant and cleaner wax
- Lightly polishes, decontaminates vehicle surfaces
- Mild cleaning and polishing agents remove micro scratches and swirls before sealing in high gloss shine

\$86.34 JS04028 32 oz.- 6 per case



SIMONIZ® DETAILING & BLEND CENTER CHEMICALS



SHOW TIME SIMONIZ

- Specially blended solvent-based formula
- Multiple silicones impart long-lasting shine
- Great wet-look results - high gloss
- Fast drying

\$151.97	PA5530	5 Gallon
\$1,615.12	DR55535	55 Gallon



DETAILERS CHOICE SIMONIZ

- Use as a quick touch-up or the finishing step
- Spray on and buff away with a microfiber cloth
- Protects waxes and sealants
- Prevents water spots
- May also be used as a clay lubricant

\$39.60	JSD0872012	32 oz. - 12 per case
\$72.63	JSD0872005	5 Gallon



BLACK BACK SIMONIZ

- High-gloss, solvent-based formula
- Rejuvenates exterior black rubber components such as wheel openings, trims, and moldings
- Gives a new look to any vehicle

\$31.51	JS3267	1 Gallon
\$145.06	PA5505	5 Gallon
\$1,453.83	DR55506	55 Gallon

CARBONITE GRAPHENE-INFUSED SURFACE HARDENER SIMONIZ



- Improves surface slickness
- Anti-corrosion against road salt/contaminates
- Infused with graphene material - harder than diamond and 200x tougher than steel

\$225.30	PA5319	5 Gallon
\$1,314.00	DR30319	30 Gallon
\$2,409.00	DR55319	55 Gallon



VINYL DRESSING SIMONIZ

- Great for vinyl, rubber, plastic, and leather
- Use on exterior and interior surfaces
- Nourishes and revitalizes dull surfaces on vehicles

\$30.89	JS4100	1 Gallon
\$152.29	PA5525	5 Gallon



MAGIC CARPET SIMONIZ

- A RTU, water-based carpet spotter and prespray that safely removes stubborn stains such as coffee, wine, blood and other spills.

\$36.22	JS2265012	32 oz., 12 per case
----------------	------------------	---------------------

EXPRESS BLEND CENTER & SECONDARY BOTTLES SIMONIZ DETAILING PRODUCTS



- Color and number coded dilution control station. Dilution presets eliminate guesswork
- Economical - uses ultra concentrated products
- 32 oz. bottles sold separately. 12 empty bottles per box. English and Spanish labels

\$358.14	JSBC	Express Blend Center
\$21.54	JSSBC61	Carpet & Upholstery Cleaner - 32 oz. secondary
\$21.54	JSSBC62	Cleaner/Degreaser - 32 oz. secondary
\$21.54	JSSBC63	Vinyl Dressing - 32 oz. secondary bottle
\$21.54	JSSBC65	Glass and Multi-Surface Cleaner - 32 oz. secondary bottle

5-GALLON ULTRA-CONCENTRATES SIMONIZ



\$50.94	PA5508	Carpet & Upholstery Cleaner	Cleans velour, carpets, headliners & vinyl panels. For medium to heavy duty soiling. Safe for all interiors.
\$293.22	PA5524	#2 Vinyl Dressing & Protectant	High-quality water-based product designed to revitalize and renourish rubber, vinyl, and plastic wheel wells
\$41.41	PA5551	Glass & Multi Surface	Quick drying glass cleaner for use on all types of glass including tinted windows. Works on all types of chrome, leaves no film.
\$37.23	PA5538	Cleaner Degreaser	All-purpose cleaner for pre-spot of carpets, engine cleaning, wheel wells, vinyl & convertible tops, white & black tires. Heavy duty exterior cleaning - bugs, road grime & gas stains
\$41.30	PA5262	Wash N' Shine	High foaming, lemon scented car wash soap for hand-washing. Excellent wetting & loosening action for spot-free rinse. Biodegradable formula. Safe for all paints.

MOTHERS® PROFESSIONAL DETAILING CHEMICALS

MOTHERS
Polishes • Waxes • Cleaners



PROFESSIONAL HEAVY DUTY RUBBING COMPOUND

MOTHERS

- Removes light scratches, defects and paint oxidation without sandpaper
- For use on 1200 grit or finer scratches

\$35.83	MD81232	32 oz.
\$60.55	MD81238	1 Gallon



PROFESSIONAL FOAM PAD POLISH

MOTHERS

- Pair with foam pads (sold separately)
- Removes minor imperfections
- Improves appearance of paint

\$28.48	MD83432	32 oz.
\$98.37	MD83438	1 Gallon



PROFESSIONAL RUBBING COMPOUND

MOTHERS

- Removes light scratches, defects and paint oxidation without sandpaper
- For use on 1500 grit or finer scratches

\$27.65	MD81132	32 oz.
\$85.27	MD81138	1 Gallon



PROFESSIONAL INSTANT DETAILER

MOTHERS

- Silicone free and body shop safe
- Unparalleled depth and clarity
- Safe on all types of paints

\$8.06	MD85624	24 oz.
\$28.13	MD85638	1 Gallon
\$107.35	MD85645	5 Gallon
\$5.86	MD85632	Sprayer/Bottle 32 oz.



PROFESSIONAL AUTO WASH

MOTHERS

- Non-toxic and biodegradable
- pH balanced and won't strip wax or leave streaks
- Suitable for use on cars, trucks, boats, and planes
- Use in washing or wet sanding
- **DILUTION:** 2 oz. per gallon of water for cleaning; adjust ratio to 1/2 oz. cleaner when used for wet sanding

\$16.42	MD80138	1 Gallon
\$77.54	MD80145	5 Gallon



PROFESSIONAL ALL-PURPOSE CLEANER

MOTHERS

- Intensely concentrated biodegradable cleaner that can be used on a variety of surfaces
- **DILUTION:** General Purpose - 1:15
Carpet, Vinyl & Upholstery - 1:10
Spot & Heavy Cleaning - 1:5
Engines, Tires, Grease - 1:3

\$12.90	MD87138	1 Gallon
\$61.13	MD87145	5 Gallon
\$5.86	MD87132	Sprayer/Bottle 32 oz.



PROFESSIONAL WATER-BASED DEGREASER

MOTHERS

- Non-toxic and biodegradable
- Cuts grease without staining paint or damaging aluminum engine components.
- Light to Moderate Degreasing - 1:4
General Purpose - 1:2
Heavy/Engine Degreasing - 1:1

\$14.33	MD87538	1 Gallon
\$65.08	MD87545	5 Gallon
\$5.86	MD87532	Sprayer/Bottle 32 oz.



PROFESSIONAL WHEEL CLEANER

MOTHERS

- Biodegradable formula suitable for use on factory/OEM wheels and hubcaps, including painted, clear coated, color coated and chrome.
- **DILUTION:** 1:10

\$20.66	MD87938	1 Gallon
\$93.30	MD87945	5 Gallon
\$5.86	MD87932	Sprayer/Bottle 32 oz.



PROFESSIONAL SILICONE-FREE DRESSING CONCENTRATE

MOTHERS

- This formula is silicone-free and water-based, so it can safely be used on any rubber and trim. It is a professional, pre-delivery prep product specifically designed for body shops.
- **DILUTION:** 1:4

\$61.32	MD88638	1 Gallon
\$301.02	MD88645	5 Gallon
\$3.63	MD88632	Sprayer/Bottle 32 oz.





PROFESSIONAL GLASS CLEANER MOTHERS

- Fast-drying, streak-free formula suitable for use on glass and windows, even works on tinted windows
- Takes care of stubborn dirt, tough grime, oil residue, and fingerprints
- **DILUTION:** General Purpose - 1:10

\$17.90	MD87638	1 Gallon
\$80.54	MD87645	5 Gallon
\$5.86	MD87632	Sprayer/Bottle 32 oz.



PROFESSIONAL VINYL & RUBBER DRESSING MOTHERS

- Great for professional detailers and detail shops
- Non-greasy finish won't attract dust and is safe for use on vinyl, rubber, plastic, and engine compartments
- Does not contain soaps, glycerin, or other extenders

\$39.18	MD88138	1 Gallon
\$200.58	MD88145	5 Gallon
\$5.86	MD88132	Sprayer/Bottle 32 oz.



PROFESSIONAL SILICONE-FREE DRESSING MOTHERS

- Ideal for pre-delivery prep
- Silicone-free and water-based. Safe for any rubber and trim
- Ready to use

\$29.29	MD88538	1 Gallon
\$140.07	MD88545	5 Gallon
\$3.77	MD88532	Sprayer/Bottle 32 oz.



PROFESSIONAL HAND GLAZE MOTHERS

- Silicone-free formula - safe for use on any paint
- Protects and shines while adding depth and clarity

\$17.43	MD84532	32 oz.
----------------	----------------	--------



SPIGOT FOR MOTHERS® PROFESSIONAL 5-GALLON CONTAINERS MOTHERS

- This spigot adapter twists directly into the opening of your 5-gallon Mothers Professional detailing containers. Simply remove the existing lid and screw this spigot into its place.
- Made of chemically-resistant High Density Polyethylene (HDPE), this 3/4" spigot is great for decanting bulk product into smaller spray bottles or dispensers.
- Threads directly into Mothers 5-gallon jug openings

\$7.87	MD80005
---------------	----------------



PROFESSIONAL DISPENSER BOTTLE MOTHERS

- Portion out polish or compound into easily manageable units with this squeeze bottle! Perfect for use with the Mothers Professional detailing product of your choice, this bottle features an empty label for versatility.
- Fill with polish or compound
- Holds 12 oz. of product

\$3.64	MD80000
---------------	----------------

New!



CONCOURS SATIN TIRE DRESSING MOTHERS

- 16 oz.
- If you're looking for a natural, flat, matte, satin, or low-sheen finish, look no further! Our unique, non-oily formula won't brown or sling, keeping your tires protected and show car perfect.

\$50.49	MD06816
----------------	----------------



6 STAGE PROFESSIONAL METERING UNIT MOTHERS

- Professional metering unit allows you to connect up to six concentrates. Effective dilution becomes as easy as pressing a button! This easy-to-install unit comes with all the parts you need for an effective setup.
- Connect up to 6 Mothers concentrates
- Includes metering box, clear hose, tips, and other necessary components

\$306.94	MD80006
-----------------	----------------



MEGUIAR'S® DETAILING CHEMICALS



SUPER DEGREASER

MEGUIAR'S DETAILING PRODUCTS



- Cuts even the toughest engine grease, also great for undercarriage degreasing
- Safe for plastic, rubber & painted surfaces

\$83.06	MGD10801	1 Gallon
\$85.89	MGD10805	5 Gallon
\$6.08	D20108	32 oz. Sprayer (Bottle Only)
\$5.38	D110516	Spray Trigger Head
\$7.62	D110542	Chem Resist Spray Trigger



ALL PURPOSE CLEANER

MEGUIAR'S DETAILING PRODUCTS



- A non-butyl cleaner that is biodegradable and packed with super wetting agents, fabric softeners, and brighteners
- **DILUTION:** up to 64:1

\$16.60	MGD10101	1 Gallon
\$76.32	MGD10105	5 Gallon
\$6.08	D20101	32 oz. Sprayer (Bottle Only)
\$5.38	D110516	Spray Trigger Head
\$7.62	D110542	Chem Resist Spray Trigger



GLASS CLEANER CONCENTRATE

MEGUIAR'S DETAILING PRODUCTS



- Ammonia-free cleaner, non-streaking, safe on tinted windows
- **DILUTION:** 10:1

\$24.93	MGD12001	1 Gallon
\$112.43	MGD12005	5 Gallon
\$6.08	D20120	32 oz. Sprayer (Bottle Only)
\$5.38	D110516	Spray Trigger Head
\$7.62	D110542	Chem Resist Spray Trigger



SHAMPOO PLUS

MEGUIAR'S DETAILING PRODUCTS

- High foaming wash plus conditioner, biodegradable, pleasant fragrance
- **DILUTION:** up to 128:1

\$20.76	MGD11101	1 Gallon
\$95.76	MGD11105	5 Gallon



HYPER DRESSING

MEGUIAR'S DETAILING PRODUCTS



- Restore and protect vinyl, leather, rubber
- High gloss, biodegradable
- **DILUTION:** 4:1 for high gloss, 1:1 for low gloss

\$99.72	MGD17001	1 Gallon
\$436.90	MGD17005	5 Gallon
\$6.08	D20170	32 oz. Sprayer (Bottle Only)
\$5.38	D110516	Spray Trigger Head
\$7.62	D110542	Chem Resist Spray Trigger



WHEEL & TIRE CLEANER

MEGUIAR'S DETAILING PRODUCTS

- Effective and easy cleaning
- Quickly removes brake dust, road grime and dirt
- Spray on, lightly agitate and hose off

\$20.76	MGD14301	1 Gallon
\$6.08	D20143	32 oz. Sprayer (Bottle Only)
\$5.38	D110516	Spray Trigger Head
\$7.62	D110542	Chem Resist Spray Trigger



HYPER WASH

MEGUIAR'S DETAILING PRODUCTS

- Produces a rich, stable foam
- Safely lifts dirt away from all surfaces
- **DILUTION:** 400:1

\$30.49	MGD11001	1 Gallon
\$152.43	MGD1105	5 Gallon



CITRUS POWER CLEANER PLUS

MEGUIAR'S DETAILING PRODUCTS



- Low foaming, solvent-free, concentrated APC for interior detailing
- Use in extractor, air tool or hand
- **READY-TO-USE**

\$17.99	MGD10701	1 Gallon
\$77.71	MGD10705	5 Gallon
\$6.08	D20107	32 oz. Sprayer (Bottle Only)
\$5.38	D110516	Spray Trigger Head
\$7.62	D110542	Chem Resist Spray Trigger

MEGUIAR'S® DETAILING & MIRROR GLAZE CHEMICALS



LAST TOUCH DETAILER

MEGUIAR'S

- Quick spray shine enhancer - enhances gloss
- Removes dust, dirt, fingerprints, contaminants
- Also great as a clay lubricant
- **READY-TO-USE**

\$21.22	MGD15501	1 Gallon
\$94.38	MGD15505	5 Gallon
\$6.08	D20155	32 oz. Sprayer (Bottle Only)
\$5.38	D110516	Spray Trigger Head
\$7.62	D110542	Chem Resist Spray Trigger



RINSE FREE EXPRESS WASH

MEGUIAR'S

- For all exterior vehicle surfaces
- Use without rinsing with this high-gloss, non-scratch, non-streak formula
- Quick and easy wipe off
- Made with biodegradable detergents

\$66.08	MGD11501	1 Gallon
----------------	-----------------	----------



LEATHER CLEANER & CONDITIONER

MEGUIAR'S

- Cleans and conditions leather and vinyl seats
- Gentle formula - non-oily, thick lotion
- Pleasant scent
- **READY-TO-USE**

\$36.04	MGD18001	1 Gallon
\$6.08	D20180	32 oz. Sprayer (Bottle Only)
\$5.38	D110516	Spray Trigger Head
\$7.62	D110542	Chem Resist Spray Trigger



WHEEL & PAINT IRON DECON

MEGUIAR'S

- Professional-strength iron remover for vehicle surfaces like paint and wheels. This neutral pH formula safely and effectively removes embedded iron particles from body panels, wheels, and painted brake components. The rapid color-changing action indicates that the formula is working.
- **READY-TO-USE**

\$67.99	MGD180101	1 Gallon
\$272.15	MGD180105	5 Gallon
\$6.08	D201801	32 oz. Sprayer (Bottle Only)
\$5.38	D110516	Spray Trigger Head
\$7.62	D110542	Chem Resist Spray Trigger



PRO FINISHING POLISH

MEGUIAR'S MIRROR GLAZE

- Quickly removes DA haze, swirls, holograms, and other light paint defects
- Professional polish creates a deep, glossy, impressive finish - even on dark and sensitive paints
- Usable when working by hand, with a polisher, or with a rotary buffer

\$36.69	MGD21032	32 oz.
\$111.15	MGD21001	1 Gallon



ALL SEASON DRESSING

MEGUIAR'S

- VOC compliant, produces deep, rich, long-lasting shine on all exterior rubber and plastic
- For use on old or new, weathered or worn

\$48.06	MGD16001	1 Gallon
\$233.58	MGD16005	5 Gallon
\$6.08	D20160	32 oz. Sprayer (Bottle Only)
\$5.38	D110516	Spray Trigger Head
\$7.62	D110542	Chem Resist Spray Trigger



SYNTHETIC X-PRESS WAX

MEGUIAR'S

- Super fast, gloss enhancing wax
- Applies quickly, dries fast, wipes off easily
- Efficient and time-saving
- Can be applied in sunshine
- **READY-TO-USE**

\$30.54	MGD15601	1 Gallon
\$6.08	D20156	32 oz. Sprayer (Bottle Only)



SILICONE-FREE DRESSING

MEGUIAR'S DETAILING PRODUCTS

- Paint shop safe, all-purpose dressing
- Restores & protects all rubber & vinyl surfaces
- Even, high-gloss shine
- VOC compliant
- **READY-TO-USE**

\$38.13	MGD16101	1 Gallon
\$6.08	D20161	32 oz. Sprayer (Bottle Only)
\$5.38	D110516	Spray Trigger Head
\$7.62	D110542	Chem Resist Spray Trigger



VINYL & RUBBER CLEANER

MEGUIAR'S MIRROR GLAZE

- Formulated to screen damaging ultraviolet rays emitted by the sun
- Ideal for cleaning and rejuvenating vinyl and rubber car surfaces.
- Results in a rich, natural sheen that restores the life and color of these synthetic surfaces

\$36.94	MGD4001	1 Gallon
\$168.18	MGD4005	5 Gallon



ULTRA PRO SPEED COMPOUND

MEGUIAR'S MIRROR GLAZE

- Advanced cutting compound provides a quick, heavy cut and a high gloss depth of shine.
- Has a long work cycle that removes up to 1,200 grit sanding marks while delivering an extremely high gloss finish.
- Formulated for restoration purposes

\$38.57	MGD11032	32 oz.
\$124.01	MGD1101	1 Gallon



MEGUIAR'S® MIRROR GLAZE DETAILING CHEMICALS



DIAMOND-CUT COMPOUND 2.0 MEGUIAR'S MIRROR GLAZE

- Speedy, low-swirl cutting compound that works well in high solids production shops
- This formula is low dust and low splatter, making it easy as well as effective to use on all clear coats, high solids, lacquers, enamels, and refinished / OEM glossy paint
- Apply with a rotary buffer

\$46.57	MGD8501	1 Gallon
----------------	----------------	----------



FINAL INSPECTION MEGUIAR'S MIRROR GLAZE

- Excellent for body shops, car washes, and professional detailers
- Use to clean up polishes and compounds, evaluate paint repairs, find defects, and as a final wipe-down
- Safe for use on all paint finishes and clear coats.
- Removes fingerprints and light contaminants while maintaining a showroom shine
- Use to spot paint defects, as a clay lubricant, or a final showroom finish

\$29.76	MGD3401	1 Gallon
----------------	----------------	----------



ULTRA CUT COMPOUND MEGUIAR'S MIRROR GLAZE

- Removes scratches, defects, acid rain, severe swirls and holograms on painted surfaces
- Composed with an exclusive super-micro abrasive technology that delivers an exceptional finish
- Apply using dual action polisher, rotary buffer, or by hand.
- Fast cutting formula removes 1200 grit or finer sanding marks

\$99.42	MGD010501	1 Gallon
----------------	------------------	----------



PRO SPEED COMPOUND MEGUIAR'S MIRROR GLAZE

- Fast cutting compound with advanced technology
- Quick removal of 1200 grit and finer sanding marks for easier polishing
- Removes deep scratches, acid rain, and severe swirls/holograms
- Works great on fresh and cured paints, and is safe and effective on all glossy paint finishes including clear coats (body shop safe)
- Formulated for use with a rotary buffer

\$62.82	MGD10001	1 Gallon
----------------	-----------------	----------



ULTRA FINISHING POLISH MEGUIAR'S MIRROR GLAZE

- Liquid detailing product formulated to deliver deep reflections and a high gloss shine on paint surfaces
- Removes swirls and light defects from vehicle paint
- Provides a smooth buffing feel during application
- Formula wipes off fast for efficient detailing operations

\$95.51	MGD20501	1 Gallon
----------------	-----------------	----------



QUICK DETAILER MEGUIAR'S MIRROR GLAZE

- Cleaner and wax blend
- Great for high production reconditioning
- Apply by hand, DA polisher, or rotary buffer
- Restores deep gloss and leaves a wax finish
- Removes oxidation and other small blemishes
- For body shops and professional detailers

\$33.00	MGD6601	1 Gallon
----------------	----------------	----------



New!

CORRECTION COMPOUND MEGUIAR'S

- 16 oz. / 6 per case

\$114.00	MGD30016	16 oz
\$91.42	MGD30001	1 Gallon



New!

FINISHING WAX MEGUIAR'S

- 16 oz. / 6 per case

\$57.92	MGD30116	16 oz
\$40.00	MGD30101	1 Gallon



ULTRA FINISHING GLAZE MEGUIAR'S MIRROR GLAZE

- 16 oz. / 6 per case

\$82.56	MGR30516
----------------	-----------------



MEGUIAR'S® DETAILING CHEMICALS



New!

PRO SPEED POLISH MEGUIAR'S

- 32 oz, 6 per case
- This professional cleaner and polish creates a deep, glossy finish on dark paints and sensitive paints that swirl and scratch easily
- A versatile cleaner polish that's safe and effective when working by hand, dual action variable speed polisher or rotary buffer on glossy paint

\$141.67 MGD20032



New!

SO10 ALL-IN-ONE MEGUIAR'S

- 32 oz, 6 per case
- Provides considerable defect removal and durable water beading protection all in one formula
- An all-new formula that builds off Meguiar's original So10 concept but with improved abrasive and wax technologies to ensure you're getting an effective cut, great polishing results, and durable protection, all in one formula

\$208.33 MGD30032



New!

ULTIMATE CERAMIC COATING MEGUIAR'S

- 8 oz, 6 per case
- A premium ceramic coating for cars that delivers ultra-durable protection with increased gloss and slickness
- To obtain the longest-lasting results, we recommend that your paint is in excellent condition before applying. Doing a full paint correction process (clay bar, compound, and polish) beforehand will ensure that you get the best bond, best performance, and best durability

\$112.50 MGR240108



New!

BEYOND CERAMIC COATING MEGUIAR'S

- **KIT INCLUDES:** 1 Meguiar's Beyond Ceramic Paint Coating 1.3oz, 1 Meguiar's Tri-Layer Microfiber Applicator, and 1 Professional Application Guide
- This premium ceramic coating for cars delivers multi-year durability with proper prep, installation, and maintenance
- Also fills in minor paint defects and enhances gloss for an enhanced and improved result upon completion

\$500.00 MGD88800



New!

ULTIMATE GLASS CLEANER & WATER REPELLENT MEGUIAR'S

- 16 oz, 6 per case
- Quickly cleans glass with streak-free results while hydrophobic technology rolls water off exterior glass improving visibility in wet and rainy conditions

\$47.08 MGR240416



New!

ALL SURFACE INTERIOR CLEANER MEGUIAR'S

- 16 oz, 6 per case
- This premium all surface cleaner is formulated for safe and thorough cleaning on ALL interior surfaces. Since it's also a pre-diluted formula there is no need for mixing or dilution ratios
- Leaves the surface with a no-gloss, OEM finish

\$34.17 MGR240616



New!

HYBRID CERAMIC WASH & WAX V2 MEGUIAR'S

- 48 oz, 4 per case
- Washes and boosts with advanced Hybrid Ceramic wax protection that will help you protect and maintain your paint
- For bucket washing, mix 2 ounces of Hybrid Ceramic Wash & Wax for every gallon of water used

\$51.94 MGR240748



New!

ULTIMATE HEADLIGHT RESTORATION KIT MEGUIAR'S

- **KIT INCLUDES:** Hand Sanding Pad (1), Sanding Discs (2), Headlight Sealant Wipe (1), and Single Use Glove (1)
- Two different grits of sanding discs thoroughly removes oxidation & preps the surface for the next step
- Headlight Ceramic Sealant dries crystal clear and is extremely durable
- Pre-saturated wipe allows for easy application
- 18+ month of clarity and no power tools required

\$88.61 MGR2990



STONER CAR CARE®



INVISIBLE GLASS CERAMIC COATING KIT

INVISIBLE GLASS

- Cutting-edge ceramic technology acts like a clear coat!
- 2 per case

KIT CONTAINS:

- 1 - 30 ml Bottle of Invisible Glass Ceramic coating
- 1 - applicator pad
- 1 - black microfiber buffing cloth
- 1 - gray microfiber buffing cloth
- 1 - pair of large nitrile gloves
- 1 - application guide

\$119.98 STN95151



TRIM SHINE CERAMIC COATING KIT

STONER CAR CARE

- Restores plastic, vinyl, and painted metal trim to showroom shine!
- 2 per case

KIT CONTAINS:

- 1 - 30 ml bottle of Trim Shine Ceramic
- 1 - Applicator pad
- 1 - Microfiber buffing cloth
- 1 - Pair of large nitrile gloves
- 1 - Application guide

\$119.98 STN95451



TRIM CLEAN

FOAMING CLEANER

- 6 per case
- 18 oz.

\$30.70 STN1134



VINYL & PLASTIC

SHINE COATING

- 12 per case
- 9 oz.

\$61.71 STN053



UPHOLSTERY

CARPET CLEANER

- 12 per case
- 18 oz.

\$56.42 STN144



LEATHER

CLEANER & CONDITIONER

- 6 per case
- 16 oz.

\$34.29 STN5400



XENIT™

CLEANER & REMOVER

- 12 per case
- 10 oz.

\$77.77 STN213



SPEED BEAD®

QUICK DETAILER

- 6 per case
- 22 oz.

\$36.19 STN2354



TIRE FINISH

AEROSOL

- 6 per case
- 12 oz.

\$46.60 STN094



TIRE FINISH

TRIGGER

- 6 per case
- 22 oz.

\$46.60 STN244



TAR & SAP

REMOVER

- 12 per case
- 10 oz.

\$71.38 STN153



AEROSOL

INVISIBLE GLASS

- 12 per case
- 19 oz.

\$45.82 STN164



TRIGGER SPRAY

INVISIBLE GLASS

- 6 per case
- 22 oz.

\$27.35 STN184

LEATHER CARE

LEATHER DEEP CLEANER

LEXOL



- Leather is constantly exposed to dirt, sunlight, heat and humidity. Leather goods can be an expensive investment, but will look their best and last longer if protected with proper care.
- Lexol pH-balanced cleaner is purely a cleaner. There are no silicones, alcohols, waxes, oils, or additives that would interfere with its cleaning action or cause dirt to be trapped in the leather.
- This pH-balanced formula maintains the pH range of leather itself, which means it cleans leather safely as well as the stitching and other fibers that hold leather together. Its foaming action loosens and lifts dirt so it can be easily wiped away, leaving no tacky residue.
- Use on: leather auto upholstery, footwear, furniture, handbags & briefcases, sports equipment, and luggage
- Contains no waxes, oils, or additives that interfere with its cleaning capabilities
- Rinses easily, leaving leather healthy, supple and able to breathe
- Leaves no tacky residue

\$128.80	LEX1112	1 Liter	12 Per Case
\$20.40	LEX1108	8 oz	6 Per Case

LEATHER CONDITIONER

LEXOL



- Soften leather with this conditioner. It works to preserve and soften leather, as well as prevent cracking. Though leather can get dry, it can look and feel "like new" for many years if properly cared for. Lexol's liquid base allows the conditioner to penetrate the surface into leather pores, for deep conditioning that prevents cracking and premature aging.
- This liquid conditioner leaves no greasy residue and it contains no harmful silicon ingredients which dry out leather over time. Lexol conditioner results in supple, strong, and beautiful leather.
- Use on: leather auto upholstery, footwear, furniture, handbags and briefcases, sports equipment and luggage
- Protects leather against cracking and premature aging
- Leaves no greasy residue

\$76.75	LEX1014	3 Liter	4 Per Case
\$20.40	LEX1008	8 oz	6 Per Case

DETAILING PRODUCTS

FABRIC REFRESHER

FEBREZE



- Deep penetrating formula cleans away odors trapped in fabrics. This cleaning product goes straight to the root of the odors to eliminate them. Pour this ready-to-use formula into a spray bottle and store the rest for later!
- Spray this Febreze Professional product right onto fabrics until slightly damp. The odors will disappear as it dries. This fabric refresher leaves behind a pleasant, light scent to keep the area smelling clean and fresh.
- 1-gallon container with cap for storage

\$23.99	PGA33032
----------------	-----------------

SIMONIZ® ELIMINATOR

SIMONIZ



- Convenient heavy duty odor eliminator and deodorant for use almost anywhere! An ideal choice for use with cleaning solutions, mop buckets, and carpet shampoos. Great for deodorizing bathrooms, trash compactors, drains, portable toilets, hotels, and nursing homes.
- Reliably deodorizes and cleans in on easy step. Get rid of odorous animal, pet, garbage, mildew, cooking, smoke, rotting food, and other unwanted smells.

SPECIFICATIONS:

- Color: Transparent
- pH: 6.0
- Foam: Low
- Biodegradable formula
- Scent: Fresh Floral
- Flash Point: None
- Viscosity: Water Thin
- Form: Liquid

DILUTION:

- Light: 1/256 (1/2 oz./gal) • Medium: 1/128 (1 oz./gal) • Heavy: 1/64 (2 oz./gal)

\$14.80	JS2107004
----------------	------------------

BRAKE AND PARTS CLEANER

DENCO



- Denco's proven Brake & Parts cleaner formula removes grease, brake dust, brake fluid, oils, and other contaminants from metal parts. Use on brake parts, lining, and pads - safe for ABS, calipers, pads, rotors, and other brake line system parts. Can also be used as a multi-purpose spray solvent on other metal surfaces - do not use on painted surfaces or rubber. Comes in easy-to-use, non-chlorinated aerosol cans for spray application. Priced for great ROI as a retail item in your convenience shop!
- Fast drying formula leaves little residue
- Aggressive formula, safe for metal surfaces
- 13 oz. aerosol cans, 12 cans per case

\$28.50	DD1930-50
----------------	------------------





GRIT GUARD® PRODUCTS

BUCKET INSERT

GRIT GUARD



- Insert fits in the bottom of your wash bucket and separates the grit from the mitt!
- Radial surface design extracts particles such as dirt, grit and grime from your wash mitt, providing a clean, scratch-free wash mitt every time you go back to the bucket for water
- 10-1/4" diameter, 2-1/2" tall
- Fits most 12" diameter buckets

\$5.99	DT1800-BK	Black
\$5.99	DT1800-R	Red

BUCKET DOLLY

GRIT GUARD



- Features 5 heavy-duty urethane casters that last longer and roll smoothly over cracks
- Two casters lock, holding your bucket in place even on steep inclines
- Supports up to 250 pounds and is securely held in place with three thumb screws
- Dolly will fit most 3.5, 4, 5, 6 and 7-gallon buckets

\$37.95	DT1804-BK	Black
\$37.95	DT1804-R	Red



UNIVERSAL PAD WASHER

GRIT GUARD



- Conditions, cleans & dries any type of buffer or polisher pad. By cleaning your dirty pad, you increase buffing effectiveness, make it easier to use, eliminate contaminants, prolong the life, and save money.
- Features convenient Gamma Seal Lid provides water tight portability to any job site. Includes a sample 4oz bottle of Pad Renewal Solution (PRS)

\$119.99	DT1808	Pad Washer Kit
\$10.95	DT1817	PRS - 16 oz.



SNAPPY GRIP™ BUCKET HANDLE

GRIT GUARD



must be < 3.75" to attach

- This ergonomic handle was designed to fit comfortably in your hand and reduce hand fatigue by more than 50% by distributing the weight over more of the surface area.
- Fits any 3.5, 4, 5, 6, or 7-gallon bucket with standard metal bails

\$1.99	DT1806-BK	Black
\$1.99	DT1806-R	Red

BUCKET WASHBOARD

GRIT GUARD



GRIT GUARD® INSERT SOLD SEPARATELY

- Works in conjunction with the Grit Guard Insert in your wash bucket to separate the grit from the mitt! Like its sister product, the Grit Guard Insert, the Grit Guard Washboard has NO flat surfaces for dirt or grit to be collected. Contaminants are extracted from cleaning tools while rubbing them on the downward stroke against the Washboard.
- Fits most 12" diameter buckets

\$8.99	DT1802-BK	Black
\$8.99	DT1802-R	Red

DUAL BUCKET CONNECTOR PLATE

GRIT GUARD



- Made of rugged diamond plate aluminum
- Easily connects two bucket dollies by simply removing two of the casters on each dolly, installing the plate over the caster holes, and then reinserting the casters.
- Used with the Dual Bucket System
- Works with 2" & 3" casters

\$17.95	DT1804-CP	
----------------	------------------	--



KNEELING PAD

GRIT GUARD



- Made from abrasion-resistant vinyl dipped 1" thick dense foam for added comfort when working low to the ground. Shiny finish is durable and washable, easily wipes clean with a damp cloth.
- 11 1/2" diameter by 1" thick

\$9.95	DT1815-BK	Black
\$9.95	DT1815-R	Red



UNIVERSAL DETAILING CART

GRIT GUARD



- The Grit Guard Universal Detailing Cart is specially designed to lift the Universal Pad Washer up to a convenient working height while providing an organized detailing workstation for all of your most commonly used products.
- Measures 24" W x 18" L x 40" H
- Accessories on cart are not included

\$159.95	DT1810	
-----------------	---------------	--



BOTTLES, SPRAYERS, FUNNELS & ACCESSORIES



JUMBO HIGH OUTPUT TRIGGER SPRAYER ONLY
HI-TECH INDUSTRIES

\$1.80	DT1153	Red/White
\$1.98	DT1153-C	Gray



TRIGGER SPRAYER
HI-TECH INDUSTRIES

\$1.09	DT1151	Red/White
\$1.09	DT1151-BL	Blue/White



CHEMICAL RESISTANT TRIGGER SPRAYER
HI-TECH INDUSTRIES

\$1.65	DT1152
---------------	---------------



ACID RESISTANT TRIGGER SPRAYER
HI-TECH INDUSTRIES

\$2.93	DT1150-A
---------------	-----------------



DELUXE CARRY CADDY
RUBBERMAID

- All-purpose caddy is perfect for carrying tools or cleaning supplies

\$17.25	WR315488
----------------	-----------------



REUSABLE AEROSOL CAN TRIGGER
DETAILING ACCESSORIES

- For use on all standard spray cans

\$3.83	DT1005
---------------	---------------



CONTAINER PUMPS
HI-TECH INDUSTRIES

- Excellent for hand sanitizer, cleaning formulas, and auto detailing chemicals
- 1 oz. per pump
- Hard plastic construction

\$3.87	DT1160	For 1 Gallon
\$4.52	DT1160-5	For 5 Gallon

New!



SELF-CLEANING POP TOP DISPENSER BOTTLE
MEGIAR'S

\$3.93	MGD9916	16 oz
---------------	----------------	-------



CLEAR PLASTIC SPRAY BOTTLE
HI-TECH INDUSTRIES

\$0.90	DT1156	16 oz
\$1.19	DT1155	32 oz



16 OZ. APPLICATOR SQUEEZE BOTTLE WITH CAP
DETAILING ACCESSORIES

\$1.23	DT1002
---------------	---------------



16 OZ. SQUEEZE BOTTLE WITH RIBBON TOP
DETAILING ACCESSORIES

\$2.07	DT1003
---------------	---------------

WATER NOZZLES & ACCESSORIES



DRUM FUNNEL WITH 2" THREAD AND LOCKABLE LID

DETAILING ACCESSORIES

- Threaded bottom screws firmly right onto your drum for easy handling and freeing up both hands
- 2-quart flow capacity, total capacity holds 4 quarts. 9½" D. Made from polyethylene plastic. 8½" H
- Spout has a two inch diameter

\$40.29 FUNNEL04



BEND & SPRAY WATER NOZZLE

WATER NOZZLES

- 8.5" Overall length
- Flexible, leakproof nozzle for use in a multitude of wash and detailing applications

\$17.52 DT1107



INDUSTRIAL HOSE NOZZLE

WATER NOZZLES

- 6" Overall length
- Ideal for high-pressure wash and detailing applications
- Durable, leakproof construction

\$11.40 DT1105



FIREMAN'S STYLE HOSE NOZZLE

WATER NOZZLES

- 4.5" Overall length
- Leakproof with a comfort grip
- Fits all standard garden and industrial hoses

\$12.59 DT1106

5 GALLON BUCKETS & ACCESSORIES

New!



BUCKET GRATE

KLEEN-RITE CORP.

KLEEN-RITE.com

- Simple, but effective way to clean mitts and pads while detailing
- Fits into a standard 5-gallon bucket (may fit 3½, 4, and 6-gallon, depending on shape)
- 10.5" diameter

\$6.15 DT1012



RED PLASTIC LID WITH POUR SPOUT & SEALING GASKET

BUCKETS & ACCESSORIES

- For use with BKT05R buckets
- 100% Prime virgin HDPE
- Tamper resistant and highly durable
- Tear tab security feature
- Proudly made in the USA
- Withstands up to 180° F

\$2.20 BKT05R-SLID

SPOUT



PAIL OPENER

BUCKETS & ACCESSORIES

- This 8" plastic lid opener is ideal for removing lids on 5-gallon pails. Color may vary and includes yellow (pictured) or black.

\$6.11 CH1019



HI-BUFF BUFFING PAD WASHER

ATTACHMENT & PAD CARE

- Effectively cleans foam, wool, and microfiber
- Works great with rotary buffer and dual action polisher pads
- Cleaning and drying process is completely contained in the 5-gallon bucket
- Prolong the life of your pads

\$109.85 DT1010



BUFFING PAD CLEANING TOOL WITH ROTATING SPURS

ATTACHMENT & PAD CARE

- This handy device is a professional tool for easy cleaning of pads and bonnets used while detailing
- Comfortable pistol grip with rubber cover
- Rotating spurs for optimal cleaning ability

\$6.59 DT1000

MARKERS, CLAY & APPLICATORS



EVERY® MARKS-A-LOT JUMBO MARKER AVERY

- Washable, 5/8" broad chisel tip, nontoxic marker
- Suitable for use on glass, paper and more
- Won't bleed through paper

\$5.43 MWX150



DETAILING CLAY MEGUIAR'S

- Safely remove bonded surface contaminants
- 200 mg bars

\$31.94 MGD2000 Mild (Blue)
\$31.94 MGD2100 Aggressive (Red)



TD642-24

TD640

6" TIRE SHINE APPLICATORS PADCO DETAILING PRODUCTS

- Holds more product and spreads easier.
- Even application to tires, less waste
- New curved shape to fit contour of tire

\$6.21 TD640 Applicator Handle
\$150.12 TD642-24 24 Count - 6" Refill Pad



TIRE DRESS EXPRESS WITH PAD CAR COASTER, LLC

- Change pads easily with hook and loop backing
- Spinning handle reduces arm & shoulder fatigue
- Keeps protectant off hands, rims & surfaces
- Rivets permanently secure Velcro® onto paddle - Use any tire dressing product! (Solvent/Water Based)

\$15.71 TD850 Applicator & Pad
\$3.73 TD850-PAD Replacement Pad



MAGNAMARK® INK REMOVER MARKERS & PENS

- Professional, safe solution for removing ink stains

\$9.79 DT1110



MAGNA SHINE® DETAILING CLAY HI-TECH INDUSTRIES

- Single Bar • 200 gram

\$16.71 CLAY2004 Medium Cut
\$16.71 CLAY2003 Light Cut



New!

MAGIC FOAM ERASER SPONGE HI-TECH INDUSTRIES

- Wet the sponge, squeeze, and then wipe away!
- 2.5" x 4.75" - 50 sponges per pack

\$27.27 DT1250



New!

DO-ALL FOAM SCRUB BLOCK HI-TECH INDUSTRIES

- Honeycomb design - safe for use on clear coats
- 3" x 5" x 3" • 12 per pack

\$25.71 DT1043

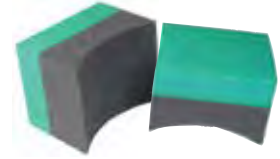

JUMBO TIRE DRESSING APPLICATOR HI-TECH INDUSTRIES

- 4" x 2.5" x 3" • Pack of 12

\$14.87 TDA3-12



CLAY BAR BOX WITH HINGED TOP CLAY & ACCESSORIES

\$2.44 CLAYBOX2



MEGUIAR'S APPLICATOR PADS MEGUIAR'S

- 4 per pack - 6 packs per case

\$29.75 MGD0004



FOAM SCRUBBING BLOCKS DETAILING SUPPLIES

- 12 per case

\$23.40 DLFSB1



10" MAGIC BUG BLOCK BRUSH HI-TECH INDUSTRIES

- Fits on standard threaded handle

\$6.59 DT1040

GLOVES



4 MIL NITRILE GLOVES

- 100 gloves per box
- Latex-free
- Ambidextrous

\$6.65	GLOVES-MN	Medium
\$6.65	GLOVES-LN	Large
\$6.65	GLOVES-XLN	Extra Large
\$15.75	GLOVES-XXLN	XX Large



6 MIL NITRILE GREASE BULLY GLOVES

- 100 gloves per box
- 50% stronger than standard nitrile
- Superior grip - textured finger
- Latex & powder-free

\$16.99	GLOVE410M	Medium
\$16.99	GLOVE410L	Large
\$16.99	GLOVE410XL	Extra Large
\$17.60	GLOVE410XXL	XX Large



8 MIL CHEMICAL RESISTANT GLOVES

- Sold by the pair
- Green, chlorinated finish - resists chemicals including aromatic and petroleum solvents

\$4.20	GLOVE300M	Medium
\$4.20	GLOVE300XL	Extra Large



15 MIL CHEMICAL RESISTANT GLOVES

- Sold by the pair
- Green, rough chlorinated finish - resists chemicals including aromatic and petroleum solvents

\$4.82	GLOVE310M	Medium
\$4.82	GLOVE310L	Large
\$4.82	GLOVE310XL	Extra Large



7 MIL NITRILE TIGER GRIP GLOVES

- Med/Large: 100 gloves per box
- Extra Large/XXL/XXXL: 90 gloves per box
- Raised texture surface for superior grip
- Powder-free and latex-free
- Hi-Vis Orange color easily seen in dark engine compartments

\$20.75	GLOVE400M	Medium
\$20.75	GLOVE400L	Large
\$20.75	GLOVE400XL	Extra Large



BLACK NITRILE GLOVES - DETAILING SUPPLIES

- 100 gloves per box

\$15.75	GLOVES-XXLN	XX Large
----------------	--------------------	----------



MEMPHIS NITRILE COATED GLOVES

- Sold by the pair
- Gray on black with knit cuff and nitrile coverage on palm and fingers

\$5.40	GLOVE200M	Medium
\$5.40	GLOVE200L	Large
\$5.40	GLOVE200XL	Extra Large



CONDOR NITRILE COATED GLOVES

- Sold by the pair
- Gray/black with knit cuff and nitrile foam coverage dots on palm

\$12.46	GLOVE220M	Medium
\$12.46	GLOVE220L	Large
\$12.46	GLOVE220XL	Extra Large



COTTON 8 OZ. JERSEY GLOVES

- Sold by the pair
- Knit cuff
- Brown
- Unlined

\$0.99	GLOVE100L	Large
---------------	------------------	-------



COTTON 10 OZ. JERSEY GLOVES

- Sold by the pair
- Knit cuff
- Brown
- Unlined

\$2.84	GLOVE110L	Large
---------------	------------------	-------

SAFETY ITEMS



BLANK TRAFFIC CONE

AHEARN



- Useful for guiding traffic
- 28" H
- PVC construction
- Blank - no branding or messaging

\$25.13	CO-BL	Blue
	CO-GR	Green
	CO-AM	Amber/Yellow
	CO-RE	Red
	CO-OR	Orange



TRAFFIC CONES

SAFETY ITEMS

- Dimensions: 28" H x 15" Base Dia. x 11" Cone Dia.
- Cone color: Orange
- Base color: Black
- Cone material: PVC
- Base material: PVC
- Base shape: Square
- Meets MUTCD requirements
- Stackable design

\$22.55	SFT2000	Solid
\$21.11	SFT2000-R	Reflective Tape



SLUSH BOOTS

SAFETY ITEMS

- Protects employees from slipping or falling in wet or icy conditions
- Heavy-duty rubber material with knit lining

PRICE	PART #	SIZE
\$52.30	DT1021-9	9
\$52.30	DT1021-10	10
\$52.30	DT1021-11	11
\$52.30	DT1021-12	12



SLIP-RESISTANT BOOT COVERS

SAFETY ITEMS

- 15" high
- Anti-slipping
- PVC/Vinyl material
- Elastic top closure
- Waterproof
- 5.5 mm thickness
- Heat-sealed seam

\$9.77	DT1022	Large
\$9.92	DT1023	X-Large



PERSONAL PROTECTIVE EQUIPMENT

CHEMICAL SPLASH SAFETY GOGGLES

SAFETY ITEMS



- Sold individually
- Impact-resistant polycarbonate lens
- Anti-splash: special vents prevent liquid from getting into eyes
- Flexible PVC construction
- 99.9% UV Protection
- Meets current ANSI Z87.1 Standard

\$3.99 SFT3025

SAFETY GLASSES

SAFETY ITEMS



- Sold in 12 packs, clear or shaded
- High impact & scratch resistant polycarbonate
- VLT %: 13
- 99.9% UV Protection
- Ultraviolet Rays 0-385nm
- ANSI Z87+
- CAN/CSA Z94.3
- MIL - PRF - 31013

\$21.19	SFT3000	Clear
\$21.19	SFT3000-S	Shaded

22 DECIBEL RATING EAR MUFFS

SAFETY ITEMS



- High performance hearing protector for use against light industry noise
- Soft wide cushions help reduce pressure around the ears and improve comfort and wearability
- Slim-line, dual moulded cups
- Electrically insulated wire headband
- Lightweight design (220g)

\$11.95 SFT1150

EAR PLUGS

SAFETY ITEMS



- Non-corded: 200/Box ; Corded: 100/Box
- Soft, hypoallergenic foam in a tapered design to fit comfortably in most ear canals
- Creates a custom seal in most ear canals
- Noise Reduction Rating: 29dB

PRICE	PART #	TYPE
\$31.95	SFT1000	Not Corded
\$30.28	SFT1000-C	Corded

RAIN SUITS

SAFETY ITEMS



- Bib front pants
- Adjustable sides, elastic suspenders
- Jacket with two flapped pockets
- Detachable drawstring hood

PRICE	PART #	SIZE
\$33.48	DT1024-M	Medium
\$33.48	DT1024-L	Large
\$33.48	DT1024-XL	Extra Large
\$23.03	DT1024-XXL	2XL

HEAD GEAR WITH .060 POLY FACE SHIELD

SAFETY ITEMS



- Sold individually
- Impact-resistant polycarbonate shield
- Curved design protects a larger area of your face
- Push and turn ratchet-sizing adjustment
- Large spark deflector
- Meets ANSI Z87.1 Standard

\$17.31 SFT3050

DENIM APRON WITH ONE POCKET

HI-TECH INDUSTRIES



- Denim construction
- Single pocket is high up on the chest for easy access to tools, pens, markers, and other accessories
- Neck loop and tie strings
- Great for auto detailing, car washes, and other shop work

\$9.64 DT1026

DENIM APRON WITH ONE POCKET

HI-TECH INDUSTRIES



- Denim construction
- Three pockets
- Neck loop and tie strings
- Great for auto detailing, car washes, and other shop work

\$12.48 DT1025

FLOOR MATS & PROTECTION PRODUCTS



DISPOSABLE FLOOR MATS

DETAILING SUPPLIES

- 17" x 20"
- 500 per case
- Plastic coating on bottoms prevents slippage and damage
- Non-slip, durable, and absorbent

\$45.32 MAT500



4 MIL. CARPET ADHESIVE FILM & DISPENSER

DETAILING SUPPLIES

- "Dealer Must Remove Protective Cover" text in industry standard pattern
- Roll wound on heavy-duty 3" cores

\$60.83	DT1130-4	24" x 200'
\$143.49	DT1130-10	24" x 500'
\$62.25	DT1130	Dispenser



UNIVERSAL SEAT COVERS

DETAILING SUPPLIES

PREMIUM

DETAILING SUPPLIES

- 7 mil. • 250 per roll

\$60.46 STC250

ECONOMY

DETAILING SUPPLIES

- 5 mil. • 500 per roll

\$60.45 STC500



UNIVERSAL STEERING WHEEL COVERS

DETAILING SUPPLIES

- 500 per case

\$53.04 SWC500



MULTI-VEHICLE SIZE WIPER BAGS

KLEEN-RITE

KLEEN-RITE.com

- These protective bags can be used in car wash bays and tunnels for everything from large SUVs to compact cars.
- Sold 20 boxes per case - 100 count boxes
- Bag measures 2½" x 5¾" x 24"

\$85.50 WWB0100



WINDSHIELD WIPER BAGS

KLEEN-RITE

KLEEN-RITE.com

- 250 bags per roll - single rolls
- Demand Quality - Expect Value! Save money with Kleen-Rite's economical yet quality line of windshield wiper bags! Available in two sizes, Kleen-Rite's windshield wipers will get the job done at a slightly lower price point than comparable brands.

PRICE	PART #	SIZE
\$16.99	KRWB1000	3" x 27"
\$20.99	KRWB2000	5" x 27"



WINDSHIELD WIPER BAGS

RETAIL PRODUCTS

- 250 bags per roll - single rolls
- Certain rear wipers are prone to damage in some car wash equipment designs. Safety bags enclose the rear wipers and provide protection against spinning brushes which can pull the wipers away. Wiper bags should be kept on-hand at car wash facilities in the event they are requested by customers.

PRICE	PART #	SIZE
\$24.77	EB82203	3" x 27"
\$28.76	EB822040	5" x 27"

PAINT CORRECTION



MAGNA SHINE™ PAINT CORRECTION TOWEL

PAINT CORRECTION



- 12" x 12" towel safely and easily removes environmental contaminants without scratching or dulling your vehicle's finish. Use up to 50 times - no reshaping required.

\$27.70 DT1015



MAGNA SHINE™ PAINT CORRECTION SPONGE

PAINT CORRECTION



- Safely and easily removes overspray, tree sap, rail dust and other bonded surface contaminants from the surface of automotive paint, glass, moldings and plastic

\$11.68 DT1016

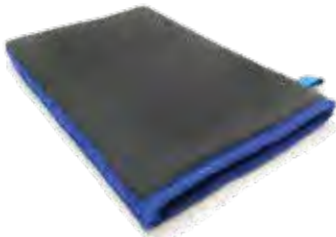

MAGNA SHINE™ PAINT CORRECTION MITT

PAINT CORRECTION



- An alternative to clay bars with an advanced rubber polymer technology

\$30.57 DT1017



MAGNA SHINE™ PAINT CORRECTION PAD

PAINT CORRECTION



- 6" diameter pad with nanofiber technology
- Suitable for vehicle surfaces

\$21.01 DT1018



SEMI-GLOSS BLACK ENAMEL SPRAY PAINT

HI-TECH INDUSTRIES

- Single 12-ounce can
- Black, semi-gloss
- Tough, durable finish for interior or exterior use
- For use on virtually any type of metal or wood
- Quick dry
- Close-up spray (8-10") reduces overspray and sagging

\$5.99 DT1200-BK



FLAT TRIM BLACK ENAMEL SPRAY PAINT

HI-TECH INDUSTRIES

- Single 12-ounce can
- Black, flat finish
- Tough, durable finish for interior or exterior use
- For use on virtually any type of metal or wood
- Quick dry
- Close-up spray (8-10") reduces overspray and sagging

\$5.80 DT1200-BK-F



STEEL WOOL, SCUFF PADS & ABRASIVES



STEEL WOOL 16 CT. PAD PACKS

DETAILING SUPPLIES

\$4.53	DT1050	#0000 Super Fine
\$4.52	DT1051	#000 Extra Fine
\$4.49	DT1052	#00 Very Fine
\$4.36	DT1056	#3 Coarse



STEEL WOOL 5 LB. REELS

DETAILING SUPPLIES

\$36.42	DT1050-5	#0000 Super Fine
\$36.44	DT1051-5	#000 Extra Fine
\$24.21	DT1052-5	#00 Very Fine
\$24.21	DT1053-5	#0 Fine
\$19.38	DT1055-5	#2 Medium Coarse
\$24.21	DT1056-5	#3 Coarse



SCUFF PADS

DETAILING SUPPLIES

\$7.61	DT1060G	6" x 9"	10 Packs	Green
\$3.75	DT1061G	4.5" x 6"		
\$7.61	DT1060	6" x 9"	10 Packs	White
\$3.89	DT1061	4.5" x 6"		

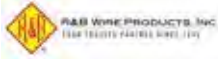

CARTS & CADDIES



CAR WASH TOWEL CART WITH DURA-SEVEN™ ANTI-RUST COATING*

R&B WIRE PRODUCTS

- 2½-bushel capacity
- 26¾" L x 22" W x 11"D x 33½" H
- Durable foot locking caster prevents cart from rolling away

\$147.48 LD5010-D7

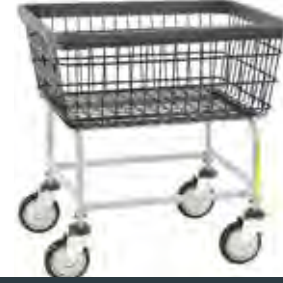

STANDARD LAUNDRY CART WITH DURA-SEVEN™ ANTI-RUST COATING*

R&B WIRE PRODUCTS

- 2½-bushel capacity
- 26½" L x 22" W x 11" D x 27" H or 66½" H with pole
- Equipped with 5" Clean Wheel System™ casters
- Available in chrome and colored vinyl

\$112.81 LD5000-D7 Standard
\$190.86 LD5001-D7 With Single Pole Rack



AVAILABLE WITH POLE!



LARGE CAPACITY LAUNDRY CART WITH DURA-SEVEN™ ANTI-RUST COATING*

R&B WIRE PRODUCTS

- 4½-bushel capacity
- 33¾" L x 21½" W x 13¾" D x 30½" H
- Equipped with 5" Clean Wheel System™ casters
- Available in chrome and colored vinyl

\$147.21 LD5005-D7



MEGA CAPACITY LAUNDRY CART WITH DURA-SEVEN™ ANTI-RUST COATING*

R&B WIRE PRODUCTS

- 6-bushel capacity
- 36½" L x 23" W x 16" D x 32½" H
- Equipped with 5" Clean Wheel System™ casters

\$228.30 LD5015-D7



FRONT LOAD LAUNDRY CART WITH DURA-SEVEN™ ANTI-RUST COATING*

R&B WIRE PRODUCTS

- 2¼-bushel capacity
- 26½" L x 23" W x 14" D x 30" H (basket tapers to 7")
- Equipped with 5" Clean Wheel System™ casters

\$151.13 LD5100-D7



4" GRAY MEGA-CASTER

R&B WIRE PRODUCTS

- Fits wire laundry carts from R&B Wire Products
- 2 mounting bolts and nuts included
- 4" diameter wheel crafted from gray polyurethane

\$15.21 LD5100



5" GRAY MEGA-CASTER CLEAN WHEEL SYSTEM™ 4 PACK

R&B WIRE PRODUCTS

- Tapered polyurethane wheel creates less floor friction and less material build up on the wheel
- Dual sealed precision bearing for smooth rolling
- Fits wire laundry carts by R&B Wire Products

\$60.82 LD5105

New!



MOBILE LAUNDRY SCALE W/POLY TUB

R&B WIRE PRODUCTS

- Holds 6-bushels of laundry
- 250 lb scale capacity
- Tub Interior Dimensions: 31" L x 16.50" W x 18.50" D

\$576.25 LD5510

*Dura-Seven™ anti-rust coating guarantees a minimum of 7 years without rust!



CARTS & CADDIES

STANDARD VINYL BASKET TRUCK, PERMANENT LINER

R&B WIRE PRODUCTS



- Vinyl flame retardant liner with heavy-duty black rim for protection
- 8-BUSHEL MODEL:**
- 8-bushel/300 lb. capacity
 - 35" L x 23½" W x 30" H (height with 3" casters)
- 12-BUSHEL MODEL:**
- 12-bushel/400 lb. capacity
 - 38" L x 28" W x 36" H (height with 5" casters)

8-BUSHEL MODELS ALL CASTERS SWIVEL			12-BUSHEL MODELS ALL CASTERS SWIVEL		
\$236.15	LD5220-1BL	Blue Truck	\$272.44	LD5212-1B	Blue Truck
	LD5220-1R	Red Truck		LD5212-1R	Red Truck
2 SWIVEL 2 RIGID			2 SWIVEL 2 RIGID		
\$236.15	LD5220-2BL	Blue Truck	\$272.44	LD5212-2B	Blue Truck
	LD5220-2R	Red Truck		LD5212-2R	Red Truck



3 LEVEL DETAILING CART

MEGUIAR'S



- Equipped with 4" rubber, silent roll, full swivel, and ball-bearing casters
- 24" W x 18" D with a 400 lb. capacity
- Rounded corners will not mark surfaces
- Engineered thermoplastic rain shelves
- Aluminum reinforced top shelf
- Resistant to acids, solvents, and petroleum-based products

\$172.64 MGCART

VINYL BUMPER TRUCK, 360 DEGREE PROTECTION, PERMANENT LINER

R&B WIRE PRODUCTS



- Fully sewn top rim non-marking air cushion bumper for additional protection along with a vinyl flame retardant liner
- 8-BUSHEL MODEL:**
- 8-bushel/300 lb. capacity
 - 36½" L x 25" W x 30½" H (height with 3" casters)
- 12-BUSHEL MODEL:**
- 12-bushel/400 lb. capacity
 - 38" L x 28" W x 36" H (height with 5" casters)

8-BUSHEL MODELS ALL CASTERS SWIVEL			12-BUSHEL MODELS ALL CASTERS SWIVEL		
\$309.16	LD5225-1B	Blue Truck	\$355.56	LD5213-1B	Blue Truck
	LD5225-1R	Red Truck		LD5213-1R	Red Truck
2 SWIVEL 2 RIGID			2 SWIVEL 2 RIGID		
\$309.16	LD5225-2B	Blue Truck	\$355.56	LD5213-2B	Blue Truck
	LD5225-2R	Red Truck		LD5213-2R	Red Truck

COLLAPSIBLE X-CART

RUBBERMAID



- Durable, easy to maneuver basket truck efficiently transports bulk loads
- Stainless steel, powder coated frame for maximum rust protection and strength to support up to 220 lbs.
- Collapsible frame for efficient storage
- Multi-Stream option provides the ability to easily divide and sort materials
- Wheel swivels provide quiet and simple movement with bumper guards for added safety and protection
- Color-coded ribbons classify transport materials to prevent cross-contamination

\$182.15	WR1881749	4 Bushel
\$208.94	WR1881750	8 Bushel



DURA-SEVEN™ LAUNDRY CART W/ DOUBLE POLE RACK

R&B WIRE PRODUCTS

- Includes two pole rack for hanging garments
- Maximum capacity of 2.5 bushels
- Equipped with 5" Clean Wheel System™ casters
- Product Weight: 41 lbs.
- 26.5" L x 22" W x 11" D x 66.5" H

APPLICATIONS:

- Humid environments & salty air

\$190.86 LD5002-D7

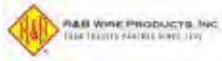

CARTS & CADDIES

New!



ELEVATED POLY LAUNDRY TRUCK

R&B WIRE PRODUCTS

- Best-in-class polyurethane tub with powder-coated tubular steel base and frame
- Equipped with swiveling 5" Clean Wheel System™ casters

6-BUSHEL MODEL:

- 200 lb. capacity
- 31.5" L x 21.5" W x 21" D x 37.5" H

8-BUSHEL MODEL:

- 250 lb. capacity
- 35.75" L x 24.5" W x 40" H

6-BUSHEL MODELS ALL CASTERS SWIVEL		
\$244.53	LD5466-BL	Blue truck ●
	LD5466-BK	Black truck ●
	LD5466-GRY	Gray truck ●

8-BUSHEL MODELS ALL CASTERS SWIVEL		
\$292.76	LD5468-BL	Blue truck ●
	LD5468-BK	Black truck ●
	LD5468-GRY	Gray truck ●

New!



ELEVATED POLY BUMPER TRUCK

R&B WIRE PRODUCTS

- Equipped with non-marking air cushion bumpers to protect facilities and equipment
- Equipped with swiveling 5" Clean Wheel System™ casters

6-BUSHEL MODEL:

- 200 lb. capacity
- 34" L x 23.75" W x 21" D x 37.5" H

8-BUSHEL MODEL:

- 250 lb. capacity
- 35.75" L x 24.5" W x 40" H

6-BUSHEL MODELS ALL CASTERS SWIVEL		
\$339.07	LD5466B-BL	Blue truck ●
	LD5466B-BK	Black truck ●
	LD5466B-GRY	Gray truck ●

8-BUSHEL MODELS ALL CASTERS SWIVEL		
\$389.87	LD5468B-BL	Blue truck ●
	LD5468B-BK	Black truck ●
	LD5468B-GRY	Gray truck ●

New!



STANDARD POLY TRUCK

R&B WIRE PRODUCTS

- Heavy duty polyurethane tub with a sturdy, powder-coated steel base
- Industrial-grade swivel casters with non-marking wheels

8-BUSHEL MODEL:

- 325 lb. capacity
- Dimensions: 35.75" L x 24.5" W x 29.25" H

12-BUSHEL MODEL:

- 425 lb. capacity
- 38.25" L x 28" W x 35.75" H

8-BUSHEL MODELS ALL CASTERS SWIVEL		
\$299.29	LD4608-BL	Blue truck ●
	LD4608-BK	Black truck ●
	LD4608-GRY	Gray truck ●

12-BUSHEL MODELS ALL CASTERS SWIVEL		
\$333.35	LD4612-BL	Blue truck ●
	LD4612-BK	Black truck ●
	LD4612-GRY	Gray truck ●

New!



POLY BUMPER TRUCK

R&B WIRE PRODUCTS

- Equipped with non-marking air cushion bumpers to protect facilities and equipment
- Heavy duty polyurethane tub with a sturdy, powder-coated steel base

8-BUSHEL MODEL:

- 325 lb. capacity
- Dimensions: 37.75" L x 26.5" W x 29.25" H

12-BUSHEL MODEL:

- 425 lb. capacity
- 41.25" L x 31" W x 35.75" H

8-BUSHEL MODELS ALL CASTERS SWIVEL		
\$388.65	LD5608-BL	Blue truck ●
	LD5608-BK	Black truck ●
	LD5608-GRY	Gray truck ●

12-BUSHEL MODELS ALL CASTERS SWIVEL		
\$434.76	LD5612-BL	Blue truck ●
	LD5612-BK	Black truck ●
	LD5612-GRY	Gray truck ●

DETAILING TOWELS

THESE TOWELS ARE FLAT PACKED - NOT SUITABLE FOR VENDING



DETAILING MICROFIBER TOWELS

FLAT PACKED CLOTHS & TOWELS

KLEEN-RITE.com

PRICE	PART #	COLOR	TYPE	SPECS
\$16.48	VSKMF1624	Navy Blue	HEAVY DUTY	16" x 24" • 12 Per Bag
\$16.48	VSKMF1624R	Red		
\$16.48	VSKMF1624G	Green		
\$37.27	VSKMF1616G	Green	MEDIUM WEIGHT	16" x 16" • 50 Per Bag
\$37.27	VSKMF1616R	Red		
\$37.27	VSKMF1616B	Blue		
\$37.27	VSKMF1616Y	Yellow		
\$27.32	VSKMF1612	Blue	MEDIUM WEIGHT	16" x 12" • 50 Per Bag



DETAILING TERRY CLOTHS

FLAT PACKED CLOTHS & TOWELS

KLEEN-RITE.com

PRICE	PART #	COLOR	TYPE	SPECS
\$19.68	VSKT350B	Blue	QUALITY • 3.5 LB	16" x 27" • 12 Per Pack
\$19.68	VSKT350G	Green		
\$19.68	VSKT350R	Red		
\$19.68	VSKT350W	White	PREMIUM • 3 LB	15" x 25" • 12 Per Pack
\$18.02	VSKT300B	Blue		
\$18.02	VSKT300G	Green		
\$18.02	VSKT300R	Red		
\$18.02	VSKT300W	White	ECONOMY • 2.5 LB	16" x 27" • 12 Per Pack
\$13.85	VSKDTNB	Navy		
\$13.85	VSKDTG	Green		
\$13.85	VSKDTR	Red		
\$13.85	VSKDTW	White		



DELUXE MICROFIBER TOWELS

HI-TECH INDUSTRIES

- 12 flat packed towels, 15" x 25"
- Affordable and long-lasting, these towels are available in blue and red.
- Guaranteed to never scratch or streak
- Pick up more dirt, dust and liquid than traditional cotton towels

\$18.82	MFT1525B	Blue
\$18.82	MFT1525R	Red



RAINWIPES® MICROFIBER DETAILING TOWELS

RAINWIPES

RainWipes®

- 100 per case, flat packed
- Eliminates swirls and scratches
- Absorbs dirt and moisture from surface
- Lint-free and non-abrasive
- Clean faster - easier - safer!
- Dries 10 times faster than cotton towels
- Use wet or dry to clean vehicle

\$70.39	RWMF1612	16" x 12"	Blue
\$132.00	RWMF1624	16" x 24"	Blue
\$132.00	RWMF1624G		Green
\$132.00	RWMF1624V		Violet
\$132.00	PTW610		Orange

What are the Best Detailing Towels?

A professional detailer usually has a towel in hand, in their back pocket, on their belt, or in their coverall pocket. Towels are perhaps one of the most important – and most overlooked – tools of the detailing trade.

What towels work best has as many answers as there are detailers! You can get answers by focusing the question – what towels work best in each part of the detailing process?

Best practices in detailing dictate that there be a logical progression to workflow. The answers to what are the best towels to use depends on knowing what stage of the detailing process we are talking about.

Every detailing job starts with washing the vehicle. Washing requires some reliable drying towels. Whether you prefer cotton or microfiber towels. Size, and weight matter. The best-selling vehicle drying towels are larger. The most popular sizes are 16"x24", 16"x27" or 24"x24". These sizes work best for cars, SUVs, and small trucks. Also, the best drying towels tend to be on the heavy side.

If you detail boats, RV's or even aircraft, consider a 20"x40" microfiber or cotton terry bath towels. You will find these and many other exceptional selections under Towels By Doctor Joe "Body Drying Towels" in the beginning of this catalog.

Next, you need rags. That's right, "rags". The door jams, trunk well, and rocker panels are usually filthy. Worn out towels, cotton towel remnants, and inexpensive microfiber towels all work well for wiping and cleaning. You will find several varieties of cleaning cloths and inexpensive microfiber towels on the next page (Page 173).

We have first-rate options available in our Polishing Towels selection. Starting with the most popular thrifty selection (DJMF4500-XX-50) – it is an all-purpose 16"x16", 300 GSM microfiber towel in nine colors. The many color choices are helpful in "color coding", assigning a specific color for an explicit task.

Also offered are plush 16" x 16", 16" x 24" and 16" x 27" cotton and microfiber towels. Rounding out the polishing cloth line, is Towelzilla, a monstrous 790 GSM microfiber towel, available 18" x 30" and 25" x 36". Towelzilla brings plush softness to a new level.

In looking at ceramic coatings, they have become a big part of the professional detailing industry. In response, Doctor Joe has developed several specialty products uniquely suitable for the application, leveling, and polishing of nano-coatings. These products are listed together under the heading of Detail Towels-Polishing on pages 173 and 174, following this article.

Many detail shops now offer "glass tinting." It is safe to assume

that you can't have lint if you are going to tint! If you are in the business, it is critical to remember that all terry towels have lint. Cotton towels generate fiber lint and microfiber terry shed filament that looks like a light dusting of snow. Under "Glass Towels – Microfiber & Cotton" in the front of this catalog (Pages 36, 37 and 38), you will discover your prayers have been answered. Products like DJMF3600- XX waffle-weave microfiber towels perfectly clean glass and windshields, lint-free! For smears and streaks, the good doctor recommends DJMF5500-XX or DJMF5600-XX. The diamond pattern on these towels cut the white haze off glass like magic.

There are easy and inexpensive remedies for having perfect windshields. It is truly the last "important detail."





DETAIL TOWELS - WIPING AND CLEANING



UTILITY TOWELS WITH COLORED CENTER STRIPE

TOWELS BY DOCTOR JOE

White terry towels with colored center stripe for color coding by use. They are an excellent, economical choice for a courtesy towel at health clubs, tanning salons detail cleaning, gyms, bars, janitorial and more. Wash and dry these towels without fabric softener prior to first use.

- Sold 12 per case
- 32 oz/dozen
- Each towel measures 16" x 19"
- Made from 100% cotton

\$5.99	DJT1680-WGD	Gold Stripe
\$5.99	DJT1680-WGN	Green Stripe



BLUE CLEANING TOWELS

TOWELS BY DOCTOR JOE

Each courtesy towel features a lightweight cotton construction. Use these towels whenever you need a hardworking, 100% cotton product to regularly wipe off hands, pick up quick messes, and more. These towels are a great choice for around-the-shop use at car washes, detail businesses, garages, gyms, tanning salons, food service, bar mop, and janitorial use. Simply wash and dry this towel before use to fluff it up!

- Sold 24 per case
- Approximately 34 oz/dozen
- Each towel measures 16" x 19"
- Lightweight - 100% cottons

\$18.70	DJT1683-BL
----------------	-------------------



ECONOMY CLEANING TOWEL

TOWELS BY DOCTOR JOE

Slightly irregular white terry cleaning towels. Fully hemmed edges prevent unravelling when washing. The most popular choice for general car cleaning – door jams, wheels, trunk well, all areas that collect oily grime and dirt. Towels are compressed to reduce shipping cost. Wash and machine dry to fluff.

- Sold in cases of 25 lb
- Approximately 170 towels per case
- Each towel measures 16" x 19"
- Medium weight- 100% cotton

\$88.00	DJT1685-W
----------------	------------------



ASSORTED COLOR TOWEL REMNANTS

TOWELS BY DOCTOR JOE

When you need a lot of polishing hand towels, but do not need specific colors, this assortment of various towels is a great, economical choice! Applications: heavy wiping and cleaning, detailing, housekeeping, and polishing. Wash and machine dry these towels prior to their first use, no fabric softener.

Because this product is sold by weight, actual number of towels per case will vary.

- Sold by weight - see options below
- Hand towel size, approximately 16" x 26"
- Medium weight, 100% cotton
- Absorbent – good choice for all cleaning purposes

\$63.46	DJT3200-25	25 lb. Pack	Approx. 105 towels per case
\$25.38	DJT3200-10	10 lb. Pack	Approx. 42 towels per case





DETAIL TOWELS - INTERIOR DETAILING & LEATHER CONDITIONING

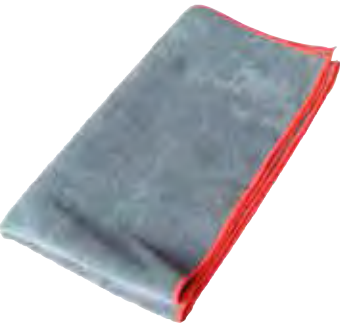

SUPER PLUSH MICROFIBER TOWEL

TOWELS BY DOCTOR JOE



Size and weight matter when cleaning leather, upholstery, and spotting automotive carpeting. Weighing in at 400 GSM this super plush towel is available in 16" x 16" and 16" x 27". The light charcoal color will not bleed or run with automotive cleaners and solvents. These phenomenal microfiber terry towels are the #1 choice for cleaning, scrubbing, dusting, mopping, drying, detailing, and wiping automotive interiors. Properly cared for, this towel is good for 500+ washings!

- Sold 12 per case
- Absorbs up to 7-10 times its weight in moisture
- Heavyweight and plush, bleach-resistant
- Attractive red stitched edge

\$22.50	DJMF8500-CHAR	Charcoal	Ultra 85	16" x 27"
\$13.95	DJMF8600-CHAR	Charcoal	Ultra 86	16" x 16"

PLUSH INTERIOR DETAILING TOWELS

TOWELS BY DOCTOR JOE



Based on the popular, absorbent "hotel towel" concept, this is a heavy-weight, 100% cotton, full-plush terry towel. This plush and absorbent towel is great for car care applications. This towel is super-absorbent after one wash and machine dry. Use as an applicator or a "spotting" wiper for upholstery and carpeting. Excellent for cleaning and moisturizing leather seats and steering wheels. This handy, all-purpose towel can be used in janitorial, food service and housekeeping applications.

- Sold 12 per case
- Each towel measures 14" x 16"
- Approximately 2.25 lb/dozen
- Heavy weight material; hotel quality
- 100% cotton, full-terry towel
- Finished with real mill end hemming

\$14.85	DJT1460-W
----------------	------------------

ALL PURPOSE MICROFIBER TOWELS

TOWELS BY DOCTOR JOE



The 300 GSM All Purpose Microfiber Towel provides the performance and durability of microfiber with the supple feel of standard cotton towels. Available in three pastel colors, this cloth furnishes the detailer with opportunity to "color code," identifying a color with a job. Safe to use on electronic equipment and other sensitive surfaces with interior detailing. Use damp for general cleaning; wet for scrubbing heavily soiled areas; and dry for dusting. Excellent for use in leather cleaning and conditioning.

- Sold 12 per case
- Each towel measures 16" x 16"
- Pastel colors do not bleed
- Safe for use on vinyl, plastics, wood, and metal

KR Part #	Color	Towels Per Pkg	Cost Per Box	Pallet Price*	
DJMF4500-BL-50	Sky Blue	50	\$19.50	288 Pkg	\$5,616.00
DJMF4500-G-50	Medium Green	50	\$19.50	288 Pkg	\$5,616.00
DJMF4500-Y-50	Yellow	50	\$19.50	288 Pkg	\$5,616.00

* Free shipping on full pallets in the lower 48

WHITE UTILITY TOWEL

TOWELS BY DOCTOR JOE



Each white utility towel features a lightweight cotton construction. Use these towels whenever you need a hardworking, 100% cotton product to regularly wipe off hands, pick up quick messes, and more. These towels are a great choice for around-the-shop use at car washes, detail businesses, garages, and more. Also for use as a courtesy towel, gym towel, tanning towel, food service, bar mop and janitorial tool.

- Sold 12 per case
- Each towel measures 16" x 19"
- 100% cotton
- Lightweight for utility applications
- 28 oz/dozen
- Wash and dry prior to first use - do not use fabric softener

\$7.25	DJT1681-WHT
---------------	--------------------





DETAIL TOWELS - POLISHING & CERAMIC



SUEDE MICROFIBER APPLICATOR/CERAMIC LEVELING TOWEL

TOWELS BY DOCTOR JOE

The Towels by Doctor Joe ULTRA-12B detailing towel is made with 260 GSM microfiber fabric that is incredibly soft and smooth. Rather than being terry or textured like other microfiber towels, these lint-free towels have a supple suede feel. These towels work incredibly well on dark-colored vehicles – orbital polisher lines just disappear! They're also great for dusting computers, wiping glass stove tops, cleaning mirrors, polishing furniture, and general housekeeping.

This towel is suitable as an applicator or for leveling, but not both. Keep towels separate.

- Sold 12 per case
- Each towel measures 16" x 16"

\$16.50 DJMF1200-BL



ELITE-01 TERRY MICROFIBER POLISHING TOWEL

TOWELS BY DOCTOR JOE

This microfiber towel was originally developed in Korea for cleaning and polishing the ceramic coated chassis boards in Smart Phones. Samsung® developed and holds some of the patents for ceramic coatings. One of their slogans is "Create the Future." Little did we know, it would pertain to nano-coatings used in the automotive appearance industry. You can be a part of this future now with Doctor Joe's ELITE-01.

- Case count varies
- 340 GSM
- Laundered to remove filament lint & yarn oil
- Made in Korea
- Each towel measures 16" x 27"
- 70% polyester / 30% poly-amide blend for extreme softness
- Ready to use right out of the package
- Use for polishing waxed surfaces and ceramic coating coatings

\$12.54 DJMF0100-BK-3 3 Pack

\$35.52 DJMF0100-BK 12 Pack



ALL-PURPOSE BUFFING TOWELS

TOWELS BY DOCTOR JOE

These Ultra-45 towels by Doctor Joe are 300 GSM microfiber towels that measure 16" square. Sold in new easy-to-manage yet economical bulk packs of 50 towels. Perfect for removal of polish, wax, compound, glaze, sealant, and detailing sprays. Use for buffing, spray waxes, and the final buff. Now offered in nine vibrant colors, helping you to color code towels for specific detailing processes.

- Sold 50 per case or by pallet
- Warp knit, overlapped finished edges
- Each towel measures 16" x 16"
- 80/20 microfiber blend



DJMF4500-RBL-50

KR Part #	Towel Color	Towels Per Pkg	Cost Per Box	Pallet Price
DJMF4500-BK-50	Black	50	\$19.50	288 Pkg \$5,616.00
DJMF4500-BL-50	Sky Blue	50	\$19.50	288 Pkg \$5,616.00
DJMF4500-DG-50	Dark Green	50	\$19.50	288 Pkg \$5,616.00
DJMF4500-DO-50	Dark Orange	50	\$19.50	288 Pkg \$5,616.00
DJMF4500-G-50	Medium Green	50	\$19.50	288 Pkg \$5,616.00
DJMF4500-P-50	Dark Purple	50	\$19.50	288 Pkg \$5,616.00
DJMF4500-R-50	Red	50	\$19.50	288 Pkg \$5,616.00
DJMF4500-RBL-50	Royal Blue	50	\$19.50	288 Pkg \$5,616.00
DJMF4500-Y-50	Yellow	50	\$19.50	288 Pkg \$5,616.00

* Free shipping on full pallets in the lower 48

LARGER ALL-PURPOSE BUFF TOWELS

TOWELS BY DOCTOR JOE

Many professional detailers prefer to work with a larger buff towel for wax removal. This towel is the big brother of the ALL-PURPOSE BUFF TOWELS, measuring 16" x 24" in size. With added surface area, the larger towel reduces buffing time. It is also less likely to get filled with wax cake. Perfect for removal of polish, wax, compound, glaze, sea lant, and detailing sprays. Use for buffing, spray waxes, and the final buff. Now offered in five vibrant colors.

- Sold 50 per case or by pallet
- Each towel measures 16" x 24"



DJMF1106-CHAR

KR Part #	Color	Towels Size	Towels Weight	Towels Per Pkg	Your Price Per Pkg	Free Shipping Full Pallet*	Towels Per Pallet
DJMF1106-CHAR	Charcoal	16" x 24"	300 GSM	50	\$50.00	168 Pkg \$8,400.00	8,400
DJMF1106-RBL	Royal Blue	16" x 24"	300 GSM	50	\$50.00	168 Pkg \$8,400.00	8,400
DJMF1106-DG	Dark Green	16" x 24"	300 GSM	50	\$50.00	168 Pkg \$8,400.00	8,400
DJMF1106-R	Red	16" x 24"	300 GSM	50	\$50.00	168 Pkg \$8,400.00	8,400
DJMF1106-BK	Black	16" x 24"	300 GSM	50	\$50.00	168 Pkg \$8,400.00	8,400

**Ask about getting Custom Towel Labels on pallet orders for FREE!

*In the lower 48



DETAIL TOWELS - PLUSH POLISHING

DJMF8500-BK



DJMF8500-CHAR

SUPER PLUSH MICROFIBER TOWEL

TOWELS BY DOCTOR JOE



These lavish towels are perfect for removing cured paste waxes and sealants. Excellent for wiping away dust, dirt, and debris or for use with spray waxes, resulting in a streak-free shine. Size and weight matter when buffing vehicles. Weighing in at 400 GSM, this unique towel is offered in two useful sizes - 16" x 16" and 16" x 27". It is the perfect towel for use with detail sprays or even the final buff. These towels have been engineered for long use, and will withstand hundreds of washings. Available in solid black or black and charcoal with a distinctive red texturized soft nylon edge banding. When properly cared for, this towel is good for 500+ washings!

- Sold 12 per case
- Heavyweight and plush, use for ceramic coatings
- Good for compound removal
- Removes, sealants, polishes, glazes, and waxes

\$22.50	DJMF8500-CHAR	Charcoal	Ultra 85	16" x 27"
\$22.50	DJMF8500-BK	Black	Ultra 85	16" x 27"
\$29.15	DJMF1500-BK	Solid Black	Ultra 15	16" x 27"
\$13.95	DJMF8600-CHAR	Charcoal	Ultra 86	16" x 16"
\$13.95	DJMF8600-BK	Black	Ultra 86	16" x 16"



TOWELZILLA™ - THE EXTREME DETAILING TOWEL

TOWELS BY DOCTOR JOE

Doctor Joe is delighted to introduce TowelZilla™, the ultimate car cloth. The towel is made from a super-thick, plush microfiber coral fleece that introduces a softness that is unrivaled in the Automotive Appearance Industry! It simply trounces the competition. Dare I say there is no competition. Everything is big about TowelZilla, except its price. Weighing in at a monstrous 780 GSM, it is available 18" x 30" or 25" x 36", both in charcoal grey. TowelZilla is equally suitable for drying vehicles, wax removal, and unsurpassed for use in the final buff. Size matters and TowelZilla is the T-Rex of towels!

- Will not scratch paint, clear coat, or other surfaces
- Maximum plushness when a higher pile is preferred
- Deep velvet pile makes it ideal for the final polish
- Guaranteed streak-free, lint-free, and non-abrasive

KR Part #	Color	Towels Size	Towels Weight	Towels Per Pkg	Pkgs Per Case	Your Price Per Pkg
DJMF1830-GRY	Charcoal	18" x 30"	780 GSM	3	12	\$23.50
DJMF2536-GRY	Charcoal	25" x 36"	780 GSM	1	20	\$12.95

DJMF2536



DJMF1830

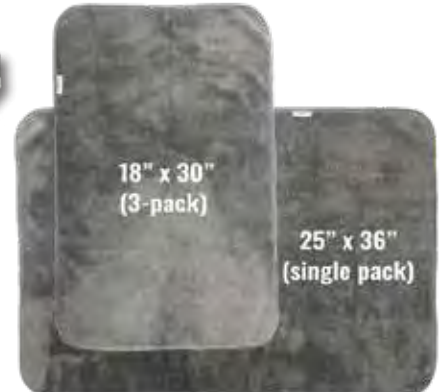

TOWELS, PADS, SPONGES, CHAMOIS & MORE



FOLDED WHITE TERRY CLOTH TOWEL

KLEEN-RITE **KLEEN-RITE** CORP.

- 100 count - folded or wrapped
- 14" x 18"
- Soft, durable, machine washable
- Reusable
- 100% cotton

\$46.72	VSKTT100	Unwrapped
\$57.52	VSKTT100W	Wrapped



FOLDED BLUE CLOTH TOWEL

KLEEN-RITE **KLEEN-RITE** CORP.

- 100 count - folded or wrapped
- 17" x 24"
- Machine washable with durable rolled-edge
- Soft, durable and absorbent 100% cotton
- This wash cloth's thick pile makes it great for areas where absorbency is crucial

\$53.68	VSKBC100	Unwrapped
\$57.66	VSKBC100W	Wrapped



CIRCULAR MICROFIBER PADS WITH HAND POCKET

QUICK DRY **Quick Dry**

- 5 circular applicator pads with pocket
- 48 per case

\$47.49	VS172
----------------	--------------



MICROFIBER CLEANING WAND

QUICK DRY **Quick Dry**

- 5" plastic stem with microfiber head
- For hard-to-reach crevices like cup holders, vents, and door nooks

\$183.75	VS176	300 per case
-----------------	--------------	--------------



RECTANGULAR MICROFIBER PADS WITH HAND POCKET

QUICK DRY **Quick Dry**

- 3.5" x 5"
- 48 per case

\$47.49	VS172R
----------------	---------------



WHITE FOLDED VENDING TOWELS

QUICK DRY **Quick Dry**

- 100 per case
- Lint free, 100% cotton
- **FREE DECAL & OVERLAY AVAILABLE!**

\$73.30	VS177	Towels
FREE	VE0102	1 Column Decal
	DEDSQDC	4" x 10" Overlay



MICROFIBER FULL SERVICE WAFFLE WEAVE TOWEL

QUICK DRY **Quick Dry**

- 17" x 26"
- 12 per case

\$21.57	VS171
----------------	--------------



LEATHER CHAMOIS SPONGE

RAINWIPES **RainWipes**

- 144 per case • 4¾" x 3"
- Foam sponge encased in leather chamois
- Great for application/removal of waxes, touch ups and drying, and window interiors

\$99.25	RWSPONGE
----------------	-----------------



DUAL SURFACE ULTIMATE MICROFIBER SPONGE

RAINWIPES **RainWipes**

- 40 sponges per case

\$128.00	RWMF21030
-----------------	------------------

DETAILING TOWELS



MAGNA SHINE® MICROFIBER DETAILING CLOTH

HI-TECH INDUSTRIES



- These car wash towels remove streaks, haze, dust, and wax residue off any surface like a magnet. They're perfect for wiping off tire dressing overspray in a single pass.
- Microfiber towels are low lint, washable, and streak-free on glass and mirrors. The microfiber material is great for all-purpose cleaning jobs
- 192 per case | flat packed
- 16" x 16"
- Perfect for removal of streaks, haze, dust and wax residue.
- Ultra-soft - will not scratch paint or clear coat

\$138.10 MFT20Y



MAGNA SHINE® WATER DEMON SYNTHETIC DRYING CLOTH

HI-TECH INDUSTRIES



- 17" x 27"
- The detail professional's go-to solution for spot-free drying
- Dries faster and better than natural chamois - Dries best when wet! Simply wring out when saturated
- Won't grab
- Comes with handy storage tube

\$11.76 DT1014

SPONGES & MITTS



3.5" X 5.5" SCRUB SPONGE

HI-TECH INDUSTRIES

- 8 Pack

\$14.88 DT1062-8



WHITE HD SCRUB SPONGES

HI-TECH INDUSTRIES

- 12 Pack

\$11.39 DT1063



GOLD WASH MITT

HI-TECH INDUSTRIES

- 8.25" x 12" x 1.72"
- Scratch-proof, double-sided
- Elastic cuff
- Highly absorbent

\$4.76 DLMIT1



KNIT WRIST WASH MITT

TOWELS BY DOCTOR JOE

- Lorene Dynel fiber
- 9" x 11"
- Scratch-proof, washable
- Knit wrist
- Highly absorbent

\$5.71 DJMITT-20



MICROFIBER MITT

TOWELS BY DOCTOR JOE

- Scratch-free microfiber
- Elastic cuff

\$2.00 DJMITT-96



MICROFIBER WASH MITT

MEGUIAR'S

- White microfiber
- 8" x 10"
- Scratch-proof, washable
- Absorbs 10x its weight in soap
- Machine washable

\$4.79 MGD3002

HAND TOOLS, SCRAPERS & BLADES



LILLY BRUSH PET HAIR REMOVER TOOL
LILLY BRUSH



- Engineered rubber blade keeps its grip for years
- Safe to use near leather, wood, and plastic with no risk of damage to hard surfaces
- Compact and convenient

\$14.99 DT2000



PRO PET HAIR REMOVAL TOOL
LILLY BRUSH



- 9" detailer tool, the big brother of the Mini Pet Hair Detailer, curved for comfort and with an easy-hold elastic strap.
- 14" crevice tool cleans between the seats, making sure the vehicle is 100% pet hair free

\$33.99 DT2001



PET HAIR REMOVAL BLOCK
DETAILING SUPPLIES

- Easily remove pet hair from vehicle upholstery, seats and carpet!

\$5.67 PTW172



PET HAIR REMOVAL BRUSH
DETAILING SUPPLIES

- Easily remove pet hair from vehicle upholstery, seats and carpet!

\$4.55 PTW173 **COLOR MAY VARY**



12" CALIFORNIA STYLE JELLY BLADE
DETAILING SUPPLIES

\$27.00 DT1070



14" CALIFORNIA STYLE WATER BLADE SQUEEGEE
DETAILING SUPPLIES

\$18.65 DT1071



BONES DETAIL STIX
DETAILING SUPPLIES

- 8 $\frac{1}{4}$ " Long, plastic

\$1.74 DT1113



10" HEAVY DUTY PARTS BRUSH
DETAILING SUPPLIES

\$6.31 DT1038



MINI BLADE SCRAPER
DETAILING SUPPLIES

- Resale bucket of 100

\$127.70 SCRPO5



11 $\frac{1}{8}$ " LONG REACH SCRAPER
DETAILING SUPPLIES

- Includes 3 blades

\$3.85 SCRPO4



MULTI-PURPOSE SCRAPER
DETAILING SUPPLIES

- 12 pack

\$5.83 SCRPO6



3 POSITION SCRAPER HANDLE
DETAILING SUPPLIES

\$3.99 SCRPO3

SINGLE EDGE PLASTIC RAZOR BLADES
DETAILING SUPPLIES

- 100 per pack

\$5.85 SCRPI5



SINGLE EDGE #9 METAL RAZOR BLADES
DETAILING SUPPLIES

- 100 per pack

\$5.95 SCRPO9



DETAILING BRUSHES



MULTI-PURPOSE RED NYLON LONG HANDLE SCRUBBER
ERIE BRUSH



- Red nylon fibers

\$11.74 EB272295



MULTI-PURPOSE BLACK & WHITE STYRENE LONG HANDLE SCRUBBER
ERIE BRUSH



- Black & white styrene fibers

\$7.89 EB272250



MULTI-PURPOSE HOGS HAIR LONG HANDLE SCRUBBER
ERIE BRUSH



- Super soft hogs hair

\$35.85 EB272298



MULTI-PURPOSE GREEN STYRENE SHORT HANDLE SCRUBBER
ERIE BRUSH



- Green styrene fibers

\$6.88 EB267055



6" HORSE HAIR UPHOLSTERY BRUSH
DETAILING BRUSHES



- Handy curved shape

\$8.91 F0900H



6" NYLON UPHOLSTERY BRUSH
DETAILING BRUSHES



- Handy curved shape

\$8.13 F0900



NOG HAIR MULTI-LEVEL WASH BRUSH
DETAILING BRUSHES

\$29.67	DT1037	Original
\$33.50	DT1042	Big Blue Brush



5" ROUND UPHOLSTERY BRUSH
UNIVERSAL BRUSH



Universal Brush

- Clean auto upholstery and headliners

\$25.02 F0901



7" TOOTHBRUSH STYLE BRUSHES
UNIVERSAL BRUSH®



Universal Brush

- Perfect for the general cleaning of small parts and detail finishing areas!

\$2.37	F01300	S/S
\$2.37	F01301	Brass
\$2.37	F01302	Horsehair



TRIPLE HEAD DETAIL BRUSH
DETAILING BRUSHES

\$2.21 DT1033



DUAL END VENT BRUSH
DETAILING BRUSHES

\$2.70 DT1030



New!

7" DETAILING DUST BRUSH
DETAILING BRUSHES

\$2.07 DT1029



EXTRA LARGE CAR DUSTER
DETAILING BRUSHES

- Paraffin treated cotton fibers, safe for all painted surfaces.
- 27" total length, 16" brush length, with a heavy-duty wooden handle

\$12.96 DT1031



VINYL & LEATHER DETAILING BRUSH
DETAILING BRUSHES

\$9.40 DT1032

BRUSHES



LIGHTWEIGHT ALL AROUNDER DETAIL BRUSH

ERIE BRUSH



- Brush only
- Natural hogs hair fill
- Lighter weight

\$113.17 EB259588



LIGHT WEIGHT WASH-N-GUARD BRUSH

ERIE BRUSH



- Brush only
- Natural hogs hair fill - 3¾" bristles
- Lighter weight

\$111.54 EB258450



TAMPICO SPOKE BRUSH

ERIE BRUSH



- 10" or 16" Tampico spoke brush

\$3.56	EB27451	10"
\$5.19	EB27450	16"



ULTRA CLOTH SPOKE BRUSH

ERIE BRUSH



- 10" or 16" Ultra cloth spoke brush

\$9.72	EB275550	10"
\$11.40	EB275580	16"



NYLON SPOKE BRUSH

UNIVERSAL BRUSH



- 10" black crimped nylon
- Vinyl coated wire

\$5.77 F01001



TAMPICO SPOKE BRUSH

UNIVERSAL BRUSH



- 16" White tampico twisted in wire with pointed end

\$6.36 F01000



TRIPLE SURFACE HOGS HAIR

UNIVERSAL BRUSH



- Extra wide coverage means less prep time. Hog filled sides for extra protection

\$111.76 F01800



HOGS HAIR ROUND PREP BRUSH

UNIVERSAL BRUSH



- This brush has hog hair all the way round the block for complete scratch-free safety. Incredibly soft

\$118.30 F01600



5" NYLON WHEEL & TIRE BRUSH

UNIVERSAL BRUSH



- 5" red nylon. GREAT for tires & rims
- One standard threaded hole means no more bending over!

\$11.04 F01104



5" WHEEL APPLICATOR BRUSH

UNIVERSAL BRUSH



- Crimped flagging holds tire cleaner better than standard brushes!

\$14.74 F01105

BRUSHES



TAMPICO WHITE WALL & TIRE BRUSH

WEILER®



- 8½" or 20" Tampico brush

\$4.31	BR0150	8½"
\$6.34	BR0152	20"



CARPET & UPHOLSTERY BRUSH

WEILER



- Poly bristle, plastic handle. Great for wet & dry cleaning, prespotting, & more

\$5.09 **BR0170**



BRASS BRISTLE WHITE WALL & TIRE BRUSH

WEILER



- Durable brass bristles

\$6.08 **BR0165**



PALMYRA WHITE WALL & TIRE BRUSH

WEILER



- 20" long handle

\$5.43 **BR0158**



New!

PREMIUM LONG-HANDLED UTILITY BRUSH

HARPER



- 20" overall length with long-lasting polystyrene fibers that are heat and chemical resistant

\$9.46 **LT231**



21" GRAY SOFT GONG BRUSH

HARPER



- 20" overall with a 3" bristle length
- Great for use as a tire brush - extra gentle split-tip polystyrene bristles

\$8.53 **LT8572**



New!

10" WASH BRUSH HEAD

HARPER



- Black and white polystyrene bristles
- Structural foam resin block

\$15.39 **LT1103**



New!

CHEMICAL & TEMPERATURE RESISTANT BUMPER BRUSH

HARPER



- 10" ultra soft green nylon bristles allow for maximum liquid retention
- Resist most acid and alkaline chemicals
- Protective bumper on block prevents dings and scratches
- Protective rubber bumper

\$23.26 **LT685510**



<https://www.homebyames.com/en-us/cleaning/brushes/>

DETAILING BRUSHES, SQUEEGEES & MORE



**11" DUAL ENDED
WHEEL BRUSH**
DETAILING BRUSHES

\$2.91 DT1035



**7" NYLON
TOOTH BRUSH**
DETAILING BRUSHES

\$1.40 DT1036



10" BLACK BRISTLE BRUSH
DETAILING BRUSHES

\$2.93 DT1041



**12" HORSEHAIR
DASHBOARD BRUSH**
DETAILING BRUSHES

• Ideal for fine cleaning of vents & radios

\$8.98 F01500

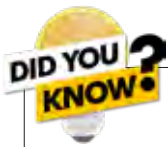

Whether you are looking for a small brush for a specific area or a large, multi-functional brush used with a long screw-in handle, we carry what you need for your detailing services.



**7" DUAL ENDED
NYLON DETAIL BRUSH**
DETAILING BRUSHES

\$1.74 DT1034

New!



SQUEEGEE WITH TELESCOPIC HANDLE

HARPER

HARPER

• Extendable 54" handle/telescoping wand facilitates easier cleaning

\$12.58 LT642 10" squeegee



24" OUTDOOR PUSH BROOM

HARPER

HARPER

• Handle & brace included • Synthetic bristles • Designed for outdoor use

\$32.97 LT7924A



10" CORN WHISK
HARPER

HARPER

• Hand broom

\$4.36 LT779



14" RED SHOP SCOOP
HARPER

HARPER

• Heavy duty • Includes storage hanger

\$25.06 LT669R

PUSH BROOMS



24" OUTDOOR PUSH BROOM
PUSH BROOMS

- 60" fiberglass handle

\$22.63 LT245



24" INDOOR PUSH BROOM
PUSH BROOMS

- Wooden handle

\$19.51 LT238



24" UNBREAKABLE HANDLE INDOOR PUSH BROOM
PUSH BROOMS

- Handle included

\$26.59 LT1425A



XL ANGLE BROOM
PUSH BROOMS

- No dust pan

\$12.35 LT476



XL ANGLE BROOM WITH DUSTPAN
PUSH BROOMS

- Dustpan included

\$10.05 LT476D



HEAVY DUTY CORN BROOM
PUSH BROOMS

- Wooden handle

\$15.73 LT469

BRUSH HANDLES



5' BLACK COATED 15/16" METAL HANDLE
HARPER

- With hang-up swivel

\$7.47 LT563

HARPER



5' LACQUERED 15/16" WOOD HANDLE
HARPER

- For squeegee

\$6.67 LT562

HARPER



4' SANDED 7/8" WOOD HANDLE
HARPER

- For squeegee

\$2.39 LT536

HARPER



5' LACQUERED 1 1/8" WOOD HANDLE
HARPER

- For squeegee

\$5.88 LT552

HARPER



BRUSH HANDLES
WEILER

WEILER

\$5.09	BR0201	4' Tapered Wooden Handle with 15/16" Metal Thread Tip ACME Thread
\$5.36	BR0212	5' Threaded Wooden Handle with 15/16" Tip ACME Thread
\$15.73	BR0213	53" Threaded 1" Fiberglass Handle with honeycomb core - Yellow
\$4.97	BR0230	5' Vortec Pro® Metal Handle with 15/16" Threaded Plastic Tip and convenient hang-up cap
\$7.05	BR0220	6' Wooden Handle with Heavy Duty 15/16" Threaded Metal Tip ACME Thread
\$1.17	BR0300	Replacement fiberglass handle thread. Fits any 15/16" diameter handle
\$2.02	BR0305	Reinforcing steel brace - Locks handle to block - FITS ALL HANDLE SIZES

TORNADOR® DETAILING TOOLS



Z-010 CLASSIC CLEANING TOOL

TORNADOR DETAILING TOOLS

- Durable with heavy duty parts. Boasts low noise and low maintenance. Blows away dirt and grime on seats, leather, tires, steering wheels, rugs, carpets and more.
- **INCLUDES:** 1 tool, 1 cap, (1) 1/4" air fitting
- **MAX. PRESSURE:** 5.4-6.2 CFM @ 90 PSI
- **INLET PORTS:** 1/4"
- **AIR CONSUMPTION:** 1/min. = 120
- **SPEED:** 3600 RPM
- **SOUND DBA:** 101.1 DBA
- **LIQUID CONSUMPTION:** 1/hr. = 3.6

\$144.50 DT0100



Z-011 FOAM GUN

TORNADOR DETAILING TOOLS

- Can be used for interior or exterior detailing - can be used with carpet cleaner or with auto shampoo
- Heavy duty parts for durability
- Air driven, works with your air compressor to produce frothy, rich foam
- 32 oz. jar is simple to refill and allows for convenient storage of leftover shampoo after use
- **INCLUDES:** Narrow nozzle (best for areas where excessive foam is not desired), Wide nozzle (best for exteriors/for more concentrated strips and less splatter, 1 tool, 1 cap, (1) 1/4" air fitting
- **MAX. PRESSURE:** 5.2-6.4CFM @ 75-90 PSI
- **INLET PORTS:** 1/4"
- **LIQUID CONSUMPTION:** 1/min. @ 70PSI - 32 oz.
- **SPEED:** 3600 RPM
- **AIR CONSUMPTION:** 1/min. = 240
- **SOUND PRESSURE DBA:** 60

\$144.50 DT0105



Z-020 BLACK CLEANING TOOL

TORNADOR DETAILING TOOLS

- This highly active cleaning tool can be used for all the same applications as the Tornador classic, but is more effective on persistent spots and heavily soiled areas. The cone-shaped nozzle and oscillating tip create a tornado cleaning action that cleans hard and soft surfaces like nothing you've seen before. Dirt and grime are immediately released from fabrics, carpet, and solid surfaces. Great for convertible tops, body seams, detailing of wheels and emblems. Features heavy duty parts for durability.
- **MAX. PRESSURE:** 5.4-6.2 CFM @ 90 PSI
- **INLET PORTS:** 1/4"
- **AIR CONSUMPTION:** 1/min. = 120
- **SPEED:** 3600 RPM
- **SOUND PRESSURE DBA:** 101.1
- **LIQUID CONSUMPTION:** 1/hr. = 3.6

\$205.00 DT0110

MAX Z-030 CLEANING TOOL

TORNADOR DETAILING TOOLS

- Progressive design that allows for individual customization through easily replaceable color handles and trigger grips
- Built-in air regulator allows precise control of the air pressure along with adding a swivel air inlet for flexibility

\$316.85 DT0130



Z-014 BLOW OUT TOOL

TORNADOR DETAILING TOOLS

- Low noise emissions • Reach tight spots and areas easily
- Heavy-duty construction

\$61.75 DT0115



ZV-200 VELOCITY VAC ATTACHMENT

TORNADOR DETAILING TOOLS

- Works in conjunction with the Tornador Black Z-020 for a powerful wet/dry vacuum combo. Simple-to-use and powerful enough to lift even the toughest dirt and grime from seat cushions

\$80.95 DT0120



ZV-240 VELOCITY VAC DRY TOOL

TORNADOR DETAILING TOOLS

- Ball bearing rotation quickly lifts dirt and grime from carpet fibers that other vacuums leave behind
- Includes 1 velocity vac dry tool, 1 inline air regulator, 2 hose adapters, 2 hose collars, (1) 30" Flexible Vac Hose, 4 Silicone tube ends, 1 allen wrench, 2 keys, 1 allen nut

\$167.95 DT0125

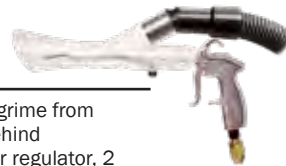

REPLACEMENT PARTS

TORNADOR DETAILING TOOLS

\$24.34	DT0001	CT-200 Repair Kit for Z-010 Classic - Weighted Tube, Cone, Gasket
\$9.72	DT0002	CT-100 Classic Nozzle for Z-010 Classic
\$14.66	DT0003	CT-101 Weighted Tube Assembly for Z-010 & Z-014
\$24.37	DT0004	CT-190 Classic Nozzle w/ Stainless Steel Lining for Z-010
\$3.62	DT0005	CT-300 Replacement Jar Cap w/ Hole for Z-010, Z-011 & Z-020
\$3.62	DT0006	CT-400 Replacement Jar Cap w/o Hole for Z-010, Z-011 & Z-020
\$23.18	DT0007	CT-404 Fine Thread Valve Body for Z-010
\$10.96	DT0008	CT-420 Plunger Assembly for Z-010 & Z-020
\$5.55	DT0009	CT-006-007 Handle Pin & Screw for Z-010, Z-011, Z-014, Z-020
\$8.49	DT0010	CT-500 Siphon Tube for Z-010 & Z-020
\$12.21	DT0011	CT-600 Liquid Inner Tube Fitting for Z-010
\$24.36	DT0012	CT-700 Air Reverse Assembly for Z-010, Z-011 & Z-020

\$8.49	DT0013	CT-800 32 oz. Replacement Jar for Z-010, Z-011 & Z-020
\$15.84	DT0014	CT-900 Upholstery Brush Nozzle for Z-010
\$24.32	DT0015	CT-1100A Foamer Tip for Z-011
\$10.94	DT0016	Foam Gun Tip Set for Z-011 - Small/Large included
\$3.00	DT0017-E	2 oz. Bottle Enzyme Cleaner Concentrate
\$3.00	DT0017-F	2 oz. Bottle Foamy Interior Cleaner
\$3.00	DT0017-S	2 oz. Bottle Sudsy Exterior Car Wash
\$48.75	DT0018	TB-200RS Black Rotation Set
\$10.98	DT0019	TB-100 BLACK Nozzle - Nozzle ONLY
\$24.36	DT0020	TB-404 BLACK Valve - Body ONLY
\$12.17	DT0021	TB-600 Inner Liquid BLACK Tube for Z-020
\$18.33	DT0022	TB-900 Upholstery Brush - Nozzle ONLY for Z-020

DEMA WALL MOUNTED FOAMING UNITS



DEMA WALL MOUNTED FOAMING UNITS

DEMA ENGINEERING

- Available in pre-mix or concentrate models. The pre-mix unit operates on a solution of chemical and water. The concentrate wall unit uses venturi technology, powered by an air pump to ensure consistent water pressure and accurate chemical dilution rates.

\$954.59	FID900WC	Wall Mount concentrate Foamer	\$866.80	FID900TL	Twin Line Foamer
			\$1,482.08	FID900DS4	Concentrated Doorway Foamer

DEMA PORTABLE FOAMERS



DEMA PORTABLE FOAMING UNITS

DEMA ENGINEERING

- Operates on compressed air and requires only a pre-mixed chemical solution to create thick, long-lasting foam. These units come in a variety of cart and tank combinations to meet the foam cleaning requirements of almost all applications and allows the operator to clean faster and more efficiently. Can be used to foam car wash tunnel and bay walls. Used to apply pre-treatment chemicals when detailing.

\$1,212.14	FID910	10 Gallon FOAMIT Unit	With Hose & Wand
\$1,154.76	FID915P	15 Gallon FOAMIT Unit	With Hose & Wand
\$1,371.41	FID925	25 Gallon FOAMIT Unit	With Hose & Wand



FOAMERS



HYDRO FOAMER

HYDRO SYSTEMS



- HydroFoamers from Hydro Systems eliminate the time and hassle of manually mixing concentrates, which not only increases labor productivity, but also increases concentrate performance because the solutions are consistently mixed as directed by the manufacturer. Since concentrates are mixed only as they are applied, they are fresh and will perform at peak power, and waste is minimized.
- 12:1 to 128:1 Dilution
- Non-electric
- Proven, reliable components
- No installation required

\$73.16 IN481



LONG-RANGE DETERGENT FOAMER

MTM HYDRO



- Applies detergent as a thick foam from over 20 ft. away with an adjustable 30° cleaning radius
- Pressure stream siphons chemical & mixes into water spray
- Includes both 1/4" Male Quick Connect & M22 threaded fittings
- Will NOT fit consumer-grade electric units w/ bayonet connectors
- 34 oz. bottle with 1.1 orifice
- Easily attaches to many pressure washers
- Requires a minimum of 1500 PSI and 2 GPM
- Use a wide variety of detergents & chemicals
- Perfect for driveways, roofs, siding and vehicles
- Maximum of 5000 PSI and 5.2 GPM

\$94.12 MTM140263 California WARNING PROPOSITION 65



PF22 FOAM CANNON

MTM HYDRO



- Pressure range: 1000 - 5000 PSI
- Maximum temperature: 140° F
- Sprays foam vertically or horizontally
- Replaceable grit filter keeps foam and flow clean
- 32 oz. easy-grip bottle
- Two optional adaptors for QC and M22
- NOTE: Foam cannons do not operate on pressure washers that have flow-sensing unloaders. Typically, you will have pulsing foam indicating pressure spikes and drops which the flow-sensing unloaders cannot accommodate.
- Flow range: 1.8 - 5.3 GPM
- For use with gas pressure washers
- Chemical injection knob with internal agitator to control foam
- Adjustable fan blades
- 1.1mm orifice included

\$84.99 MTM147022 California WARNING PROPOSITION 65



HIGH PRESSURE INJECTOR FOAMER LANCE

GENERAL PUMP



- Comfortable, impact-resistant housing with a forged brass body and stainless steel diffuser
- Made from brass, stainless steel, Viton and plastic
- 6.5 maximum flow rate
- 1/4" female inlet
- 3200 PSI maximum pressure
- 140° F maximum temperature
- 1 liter (32 ounces) tank size

\$84.30 GPYLS12T



PDS TANK SPRAYERS



3 GALLON DRESS-PRO TIRE APPLICATOR

PDS TANK SPRAYERS

- 3-gallon tank
- Comes with 15' hose
- **NOT FOR ANY ACID OR HIGH OXIDIZERS**

\$339.93 PDSDP01



STAINLESS STEEL TANK SPRAYER

PDS TANK SPRAYERS

- Comes with hose
- You can completely empty this sprayer with a single charge over 100 PSI
- **NOT FOR ANY ACID OR HIGH OXIDIZERS**

PRICE	PRODUCT	GALLONS	SIZE
\$313.25	PDS3GTS	3	15' hose
\$353.30	PDS5GTS	5	25' hose



3 GALLON PORTABLE STAINLESS STEEL TANK SPRAYER

PDS TANK SPRAYERS

- 3-gallon tank
- Comes with 15' hose
- **NOT FOR ANY ACID OR HIGH OXIDIZERS**

\$326.61 PDS3GTS-2C



New!

STAINLESS STEEL TANK SPRAYER W/STRAIGHT HOSE

PDS TANK SPRAYERS

- 5-gallon with quick connect coupler
- **NOT FOR ANY ACID OR HIGH OXIDIZERS**

PRICE	PRODUCT	INCLUDES
\$468.91	PDS5GTS-3	15' straight hose, trigger gun, quick connect coupler, 50 mesh strainer
\$484.74	PDS5GTS-3S	15' straight hose, trigger gun, <i>extra durable</i> stainless steel quick connect coupler, 50 mesh strainer

PDS SPRAYER REPLACEMENT PARTS



TANK LID

PDS SPRAYER PARTS

- Stainless steel
- Built-in air intake

\$44.08 PDSTC02



SAFETY RELIEF VALVE

PDS SPRAYER PARTS

- Stainless steel

\$18.58 PDSSFTY3SS



DRESS PRO BRUSH HEAD WITH NOZZLE

PDS SPRAYER PARTS

- Brush head only
- Has embedded spray tip nozzle in head

\$27.07 PDSDP02

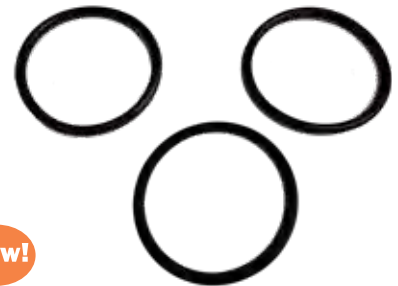

New!

O-RINGS

PDS SPRAYER PARTS

- Viton material

\$12.29	PDSCG02	Large Sprayer Tank Lid Seal
\$17.26	PDSCG-1	EPDM O-Ring for 5GTS Tank Sprayers
\$12.95	PDSCG-2	CG-2 for 5GTS Tank Sprayers
\$17.26	PDSCG-4	Buna nitrile rubber for 5GTS



PDS SPRAYER REPLACEMENT PARTS

HOSE ASSEMBLIES

PDS SPRAYER REPLACEMENT PARTS

PRICE	PART #	DESCP.	LENGTH
\$48.29	PDSCH15	W/Assembly	15'
\$55.75	PDS25CH2	W/Assembly	25'
\$46.00	PDS25CH1	Hose Only	25'



PDSDP04

PDSDP03

PDSTV1

PDSBHS1

PDSSGTJ1

PDSFM01

MORE REPLACEMENT PARTS

PDS SPRAYER REPLACEMENT PARTS

- PDS Sprayer replacement parts

\$12.29	PDSBHS1	1/4" Brass Hose Swivel
\$85.01	PDSDP03	Dress Pro Gun & Brush Head Assembly
\$109.58	PDSDP04	Dress Pro Hose with Brush and Gun
\$38.27	PDSFM01	Foam Aeration Nozzle
\$49.19	PDSSGTJ1	Trigger Jet Spray Gun
\$12.91	PDSTJKIT	Repair Kit for Plastic Trigger Jet Gun
\$8.61	PDSTV1	Chrome Tire Valve with Viton Grommet

BUFFING PADS & BACKING PLATES



URO-WOOL™ PADS

BUFF & SHINE



- 100% knitted wool cutting pads
- Clean with buffing pad spur - washable

PRICE	PART #	LOOP DIA.	PILE HT.	QTY	MACHINE
\$19.99	BS10-3KWC	3.125"	.50"	2	Standard DA
\$11.99	BS10-5KWC	5.125"	.75"	1	Gear Driven/ Long Throw DA
\$12.99	BS10-6KWC	6.125"	.75"	1	

ATTACHMENTS

BUFF & SHINE

- Recommended for rotary polishers
- Made from durable polyester foam and wools
- Color coded for buffing aggressiveness
- Recessed backing protects painted surfaces from backing plate edges

PRICE	PART #	DESCRIPTION	COLOR	QTY
\$12.53	BS1948	7" Diameter Backing Plate	Black	1
\$9.40	BS2000G	Foam Pad	Black	
\$9.40	BS3000G	Foam Pad	Yellow	
\$9.87	BS7503GT	7.5" Wool Buffing Pad	Natural	1
\$8.75	BS825GT	8" Foam Pad	Black	
\$8.75	BS835GT	8" Foam Pad	Yellow	
\$10.08	BS980GT	Foam Pad	Orange	



URO-FIBER™ MICROFIBER PADS

BUFF & SHINE



- Designed to fully maximize the detailing potential already seen in microfiber pads. With a 25% lower pile than traditional microfiber pads, Buff and Shine Uro-Fiber Pads also feature a blend of two different microfiber grades into just one pad. These two features, never before seen in a microfiber pad, allow you to cut, polish and finish in just one step!

BLACK & WHITE PADS

PRICE	PART #	LOOP DIA.	FOAM THICK.	QTY	MACHINE
\$29.99	BS12-192MFP	1.5"	.375"	6	Mini Polisher
\$23.99	BS12-292MFP	2.25"		4	
\$19.99	BS12-392MFP	3"		2	Standard DA
\$11.99	BS12-592MFP	5"		1	Gear Driven/ Long Throw DA
\$12.99	BS12-692MFP	6"	1		

BLACK PADS

PRICE	PART #	LOOP DIA.	FOAM THICK.	QTY	MACHINE
\$19.99	BS12-392MFP-BK	3"	.375"	2	Standard DA
\$11.99	BS12-592MFP-BK	5"		1	Gear Driven/ Long Throw DA
\$12.99	BS12-692MFP-BK	6"		1	

Check out more options online!



New!

BIGFOOT POLISHER KIT

RUPES USA, INC.

FEATURES:

- (1) LHR21ES Bigfoot Polisher
- (1) 981.321N 150mm/6in backing plate
- (1) 9.DACOARSE250 250ml coarse compound
- (1) 9.DAFINE250 250ml fine compound
- (1) 9.PURE250 250ml ultrafine polish
- (1) 9.DA180H coarse blue foam pad
- (1) 9.DA180M fine yellow foam pad
- (1) 9.DA180S ultrafine white foam pad
- (1) 9.BW180H coarse DA wool pad
- (1) 9.BW180M medium DA wool pad
- (1) 9.BF9050 blue microfiber towel
- (1) 9.BF9060 yellow microfiber towel
- (1) 9.BF9070 white microfiber towel
- (1) 9.BF7001 Claw Pad Tool
- (1) 9.Z1024 Cable Clamp
- (1) 9.Z868 detailing apron
- (1) Semi-rigid Bigfoot carrying bag

SPECIFICATIONS:

- 6" backing plate
- 21mm orbit (13/16")
- 500W operation
- RPM Range: 2000-4200
- Want just the polisher? Use KR part #LHR21ES

\$552.00 LHR21ES-CMP



New!

BIGFOOT POLISHER KIT

RUPES USA, INC.

FEATURES:

- (1) LHR15ES Polisher
- (1) 980.027N 125mm/5in backing plate
- (1) 9.DACOARSE250 250ml coarse compound
- (1) 9.DAFINE250 250ml fine compound
- (1) 9.PURE250 250ml ultrafine polish
- (1) 9.DA150H coarse blue foam pad
- (1) 9.DA150M fine yellow foam pad
- (1) 9.DA150S ultrafine white foam pad
- (1) 9.BW150H coarse DA wool pad
- (1) 9.BW150M medium DA wool pad
- (1) 9.BF9050 blue microfiber towel
- (1) 9.BF9060 yellow microfiber towel
- (1) 9.BF9070 microfiber towel
- (1) 9.BF7001 Claw Pad Tool
- (1) 9.Z1024 Cable Clamp
- (1) 9.Z868 detailing apron
- (1) Semi-rigid BigFoot carrying bag

SPECIFICATIONS:

- 5" backing plate
- 15mm orbit (19/32")
- 500W operation
- RPM Range: 2000-5000
- Want just the polisher? Use KR part #LHR15ES

\$525.00 LHR15ES-CMP

BIGFOOT LH19E ROTARY POLISHER

RUPES USA, INC.

FEATURES:

- Anti-vibration loop handle included
- Anti-vibration side handle available separately
- Lightweight, compact, and ergonomic design
- Electronic speed control dial
- Progressive trigger acts as a throttle, allowing the operator to control speeds within the dial range
- 9 Meter (29½") electrical cord

SPECIFICATIONS:

- Includes 5" backing pad standard. 6" and 6½" backing pads available separately
- Powerful 1200 watt motor
- RPM Range of 450-1700 RPM
- Weight: 4.85 lbs.

\$380.77 LH19E

BIGFOOT LHR15ES RANDOM ORBITAL POLISHER

RUPES USA, INC.

FEATURES:

- Balanced design is perfect for detailing applications
- Low vibration and smooth operator experience
- Precise electronic speed control dial
- Trigger lock allows the polisher to be locked on so operator can move both hands freely
- 15 mm (19/32") orbit

SPECIFICATIONS:

- 5" backing plate
- 500 watt motor
- RPM Range of 2000-5000 RPM
- Weight: 5.73 lbs.

\$315.00 LHR15ES



RUPES® USA, INC. POLISHERS

BIGFOOT LHR15 MARK III RANDOM ORBITAL POLISHER

RUPES USA, INC.

FEATURES:

- Latest generation BigFoot 15mm polisher
- High-visibility, electronic, speed control dial
- Progressive trigger acts as a throttle, allowing the operator to control speeds with the dial range
- 15 mm (19/32") orbit makes this one of the tightest around, perfect for cutting tight curves
- 9 meter (29.5') electrical cord

SPECIFICATIONS:

- 5" backing plate
- High efficiency 500 watt motor with 30% more output
- RPM Range of 3000 - 5200 RPM
- Weight: 5.73 lbs.

\$315.00 LHR15ES



BIGFOOT LHR75E MINI RANDOM ORBITAL POLISHER

RUPES USA, INC.

FEATURES:

- Compact design, perfect for polishing complex areas or working in tight spaces
- Variable speed, electronic control dial
- On/off switch lock allows the polisher to be locked on so operator can move both hands freely
- 12 mm (½") orbit provides powerful defect removal while maintaining safety around edges

SPECIFICATIONS:

- 3" backing plate
- 400 watt motor
- RPM Range of 4000 - 5500 RPM
- Weight: 5.07 lbs.

\$315.00 LHR75E



BIGFOOT LHR21ES RANDOM ORBITAL POLISHER

RUPES USA, INC.

FEATURES

- 21mm orbit! The largest orbit platform available in the BigFoot polisher range of tools
- Balanced internals for smooth operation
- Electronic speed control module
- Trigger lock allows the polisher to be locked on so operator can move both hands freely
- Powerful defect removal with incredible finishing capability
- 9 meter (29½') electrical cord

SPECIFICATIONS

- 6" backing plate
- 500 watt motor
- RPM Range of 2000 - 4200 RPM
- Weight: 5.73 lbs.

\$335.00 LHR21ES



BIGFOOT LHR21 MARK III RANDOM ORBITAL POLISHER

RUPES USA, INC.

FEATURES

- The latest generation of the flagship RUPES BigFoot Polisher
- Electronic speed control module
- Progressive trigger acts as a throttle, allowing the operator to control speeds within the dial range
- 21 mm (13/16") orbit for incredible correction speed, and impressive finishing.
- 9 meter (29½') electrical cord

SPECIFICATIONS

- 6" backing plate
- High efficiency 500 watt motor with 30% more output
- RPM Range of 3000 - 4500 RPM
- Weight: 5.95 lbs.

\$490.00 LHR21III



RUPES® USA, INC. POLISERS & PADS

BIGFOOT LK900E MILLE GEAR-DRIVEN DUAL ACTION POLISER

RUPES USA, INC.

FEATURES

- Gear-driven orbital movement produces consistent polishing action
- High-visibility electronic speed control dial
- Ergonomic, rubberized grips
- Internally balanced for operator comfort
- 9 Meter (29½') electrical cord

SPECIFICATIONS

- 6" & 5" backing plate included
- Powerful 900 watt motor
- RPM Range of 265 - 535 RPM
- Weight: 6.17 lbs.

\$520.00 LK900E



FOAM POLISER PADS WITH CONTOUR EDGE DESIGN

RUPES USA, INC.

- All pads listed are compatible with random orbital and gear-driven orbital tools, not intended for rotary polisher use

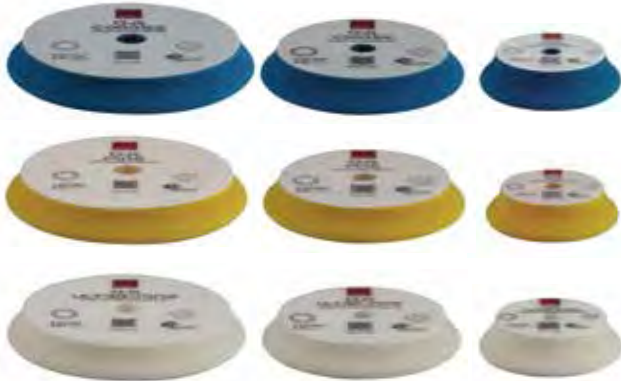

PRICE	PART #	TEXTURE	COLOR	FACE	BACKING
\$11.28	9DA180H	Coarse	Blue	7"	6"
\$10.77	9DA150H	Coarse	Blue	6"	5"
\$8.02	9DA100H	Coarse	Blue	4"	3"
\$11.28	9DA180M	Fine	Yellow	7"	6"
\$10.77	9DA150M	Fine	Yellow	6"	5"
\$8.02	9DA100M	Fine	Yellow	4"	3"
\$11.28	9DA180S	Ultrafine	White	7"	6"
\$10.77	9DA150S	Ultrafine	White	6"	5"
\$8.02	9DA100S	Ultrafine	White	4"	3"

FLEX

FLEX XFE 7-15 150 POLISER & ACCESSORIES

THE FINISHER (XFE 7-15 150) ORBITAL POLISER

FLEX ORBITAL POLISERS

- VR microprocessor control allows for constant speed control, soft start, continuous control trigger, restart protection, overload protection, temperature monitoring and speed selection
- Free-spinning drive for hologram-free finishing
- Efficient 15 mm orbit
- Cushioned special hook and counterweight facilitates smoother operation
- Optimized air flow deters troublesome exhaust
- Operational in any position thanks to flat gear head
- SoftGrip® grip hood allows for precision control
- Low heat generation
- Comes standard with 1 special velcro backing pad (6")

SPECIFICATIONS

- **PAD DIA.:** 6½"
- **BACK-UP PAD DIA.:** 6"
- **ORBIT:** 15 mm
- **ORBIT RATE:** 3200-9600 OPM
- **POWER:** 8.6 amp
- **CABLE LENGTH:** 13'

\$472.50 FLEX436712



PRICE	PART #	DESCRIPTION	TEXTURE	COLOR	SIZE
\$22.99	FLEX487988	Pad Backing Plate, Cushioned	Medium-hardness	-	6"
\$18.99	FLEX700137	Cutting / Go to pad	Thin	Orange	6½"
\$19.99	FLEX750224	Cutting / Go to pad	Thick	Orange	6½"
\$18.99	FLEX700143	Ultimate Finishing Pad	Thin	Black	6½"
\$19.99	FLEX750232	Ultimate Finishing Pad	Thick	Black	6½"
\$18.99	FLEX700135	Heavy Compounding Pad, For Spot Repair	Thin	Gray	6½"
\$19.99	FLEX750222	Heavy Compounding Pad, For Spot Repair	Thick	Gray	6½"
\$18.99	FLEX700139	Silky Foam Pad	Thin	White	6½"
\$11.72	FLEX750226	Silky Foam Pad	Thick	White	6½"
\$10.48	FLEX750126	Silky Foam Pad	Thick	White	5½"
\$18.99	FLEX700141	All-In-One Pad	Thin	Red	6½"
\$11.10	FLEX700131	All-In-One Pad	Thin	Red	5½"
\$19.99	FLEX750228	All-In-One Pad	Thick	Red	6½"
\$19.99	FLEX750128	All-In-One Pad	Thick	Red	5½"

FLEX XC 3401 VRG POLISHER



THE BEAST (XC 3401 VRG) ORBITAL POLISHER

FLEX ORBITAL POLISHERS

- Seven-fold microprocessor electronics with consistent speed control, soft start, accelerator trigger switch, restart and overload protection temperature monitoring and speed selection
- 8 mm orbital movement
- Facilitates an even, uniform polish thanks to a permanent direct drive
- Removable ergonomic knob grip
- High-power motor for handling tough jobs and extreme loads
- Protects brushes from damage thanks to auto shut-off feature if brushes become too worn
- Comes standard with 1 grip cover, 1 knob grip, 1 special velcro backing pad (5.5")

SPECIFICATIONS

- **PAD DIAMETER:** 6"
- **VELCRO PAD:** 150 mm
- **SPEED:** 160-480 RPM
- **POWER:** 900 watts
- **POWER OUTPUT:** 590 watts
- **ORBIT:** 8 mm
- **ORBIT RATE:** 3200-9600 OPM

\$472.50	FLEX334839	10' Cord
\$524.99	FLEX392715	25' Cord



DETAILING PADS FOR XC 3401 VRG

FLEX ORBITAL POLISHER ACCESSORIES

\$19.99	FLEX651100	Blue Coarse Sponge Pad, 6½" x 1¼"
\$19.99	FLEX651150	White Polishing Pad, 6" x 1¼"
\$19.99	FLEX651250	Red Ultra Finishing Pad, 6" x 1¼"
\$41.99	FLEX342637	Velcro Backing Plate for 5½" Pads
\$29.99	FLEX452661	Velcro Backing Plate for 4¾" Pads

FLEX 8-4 80 POLISHER



KOMPAKT (PE 8-4 80)

FLEX ORBITAL POLISHERS

- VR electronic control, stepless speed selection, tachogenerator with constant speed control, overload protection, restart inhibition and temperature monitoring
- High power motor for handling extreme loads
- Spindle lock prevents operating error and does not interfere with grip area

SPECIFICATIONS:

- **PAD DIAMETER:** 3"
- **BACK-UP PAD DIA.:** 3"
- **SPEED (W/O LOAD):** 1300-3900 RPM
- **POWER INPUT:** 7.6 amps

\$234.25	FLEX411752	10' Cord
\$222.99	FLEX439711	25' Cord

POLISHING PADS FOR PE 8-4 80

FLEX ORBITAL POLISHER ACCESSORIES

\$4.05	FLEX555120	Orange Heavy Pad, 1"	\$4.08	FLEX555150	Black Soft Pad, 1"
\$7.99	FLEX555115	Orange Heavy Pad, 2"	\$7.99	FLEX555145	Black Soft Pad, 2"
\$9.99	FLEX555110	Orange Heavy Pad, 3"	\$5.54	FLEX555140	Black Soft Pad, 3"
\$4.37	FLEX555135	Green Medium Pad, 1"	\$16.99	FLEX556111	Yellow Backing Pad, 1"
\$4.43	FLEX555130	Green Medium Pad, 2"	\$17.99	FLEX556115	Yellow Backing Pad, 2"
\$5.47	FLEX555125	Green Medium Pad, 3"	\$11.05	FLEX556125	Yellow Backing Pad, 3"



BACKING PAD



POLISHFLEX (PE 14-2 150)

FLEX ORBITAL POLISHERS

- VR electronic control facilitates stepless speed selection, tacho-generator-controlled constant speed, overload protection restart inhibition and temperature monitoring
- Continuous speed control trigger
- Optimized air flow deters troublesome exhaust
- Angular gears reduce operation noise
- Flat gear head allows for use in any position
- SoftGrip® grip hood facilitates precision control
- Rubberized backing

SPECIFICATIONS

- PAD DIAMETER: 6"
- BACK-UP PAD DIAMETER: 8"
- SPEED: 600-2100 RPM
- POWER: 10 Amp input, 880 Watt output
- TOOL FIXTURE: 5/8"
- MOTOR: 1400 Watt

\$472.50	FLEX373923	Polisher
\$36.99	FLEX289957	Velcro Backing Pad

BACKING AND POLISHING PADS NOT INCLUDED, EACH SOLD SEPARATELY



RANDOM ORBITAL POLISHER (XFE 7-12 80)

FLEX ORBITAL POLISHERS

- VR electronic control facilitates stepless speed selection, tacho-generator-controlled constant speed, overload protection restart inhibition and temperature monitoring
- Free-running drive
- SoftGrip® grip hood facilitates precision control
- Lightweight, handy for use in smaller areas
- Low heat generation

SPECIFICATIONS:

- PAD DIAMETER: 3"
- BACK-UP PAD DIAMETER: 3"
- ORBIT RATE: 1800-5500 RPM
- ORBIT: 12 mm
- POWER: 700 watt

\$399.99	FLEX447145
-----------------	-------------------

BACKING AND POLISHING PADS NOT INCLUDED, EACH SOLD SEPARATELY



ERGONOMIC ROTARY POLISHER WITH SPEED CONTROL TRIGGER (PE 14-3 125)

FLEX ORBITAL POLISHERS

- VR Microprocessor Control: With Tachogenerator Constant Speed Control
- Soft Start
- Continuous Speed Control Trigger
- Restart Protection After Power Failure
- Overload Protection
- Temperature Monitoring
- Speed Selection
- Spindle lock
- 4 meters PUR H05-BQF cable: wear-resistant, flexible, resistant to cuts and abrasions
- Accelerator switch for a slow and gentle start
- Works with polishing pads from Ø 80 mm to Ø 160 mm
- Recommended polishing pad Ø 140 mm
- Ergonomic designed slim shaft handle grip cover optimizes handling reducing fatigue when polishing

\$335.99	FLEX494704
-----------------	-------------------



XFE 15 150 18V CORDLESS ORBITAL POLISHER

FLEX ORBITAL POLISHERS

- The FLEX XFE15 150 Cordless Orbital Polisher is an orbital polisher with a 15 mm throw that will remove swirls, scratches, and more from your paint – all without having to plug in a cord!
- Brushless motor with greater efficiency and a longer service life
- Electronic management system protects the machine, extends service life and increases efficiency.
- Free spinning drive for hologram-free finishing.
- Low heat generation on the surface makes it ideal for temperature sensitive paints.
- Sold in a set with 2 - 5.0 Amp Batteries and Charger or sold alone

SPECIFICATIONS:

- PAD DIAMETER: 6½"
- BACK-UP PAD DIAMETER: 6"
- SPEED: 2300-3800 RPM
- ORBIT: 5½"
- BATTERY CAPACITY: 5.0 Ah (2.5 Ah x 2 batteries)

\$599.99	FLEX459542	Polisher, 2 batteries and charger set
\$499.99	FLEX463000	Polisher Only

HANDLE, BACKING AND POLISHING PADS NOT INCLUDED, SOLD SEPARATELY



FLEX POLISHERS & ACCESSORIES

PE 150 18V CORDLESS ROTARY POLISHER

FLEX ORBITAL POLISHERS



- Electronic management system (EMS) protects the machine, extends service life, and increases efficiency
- Brushless motor with greater efficiency and a longer service life
- Continuous speed control trigger for a gentle start and a lock-on for continuous operation.
- Front housing: ergonomically shaped with SoftGrip
- Spindle lock: ideally positioned to prevent operating error and does not interfere with the grip area
- Rubberized resting bar for safe setting down

SPECIFICATIONS

- PAD DIAMETER: 6½"
- BACK-UP PAD DIAMETER: 6"
- SPEED: 150-1450 RPM
- ORBIT: 5½"
- BATTERY CAPACITY: 5.0 Ah (2.5 Ah x 2 batteries)

\$629.99	FLEX459569	Polisher with 2 batteries and charger set
\$524.99	FLEX463027	Polisher Only
\$36.99	FLEX289957	Velcro Backing Pad

**HANDLE AND PADS
NOT INCLUDED,
EACH SOLD SEPARATELY**

BATTERY PACKS FOR 18V CORDLESS POLISHERS

FLEX ORBITAL POLISHER ACCESSORIES



- 18V lithium ion cells
- Phase-changing material for heat management
- Intelligent Electronic Management System to control working process
- Charge level gauge
- Dust and water protection
- Integrated charge and discharge protection
- KEEP CONTROL™ intelligent battery management system

- KEEP COOL efficient battery cooling system
- Use with the Flex **FLEX456993** battery charger
- High-performance cells utilize the full battery capacity for longer battery run times
- Works with the following cordless model polishers:
PE 150 18.0-EC (**FLEX463027**) &
XFE 15 150 18.0-EC (**FLEX463000**)

\$84.99	FLEX461083	Single parallel cells - 2600mA-h pack
\$108.32	FLEX461091	Dual parallel cells - 5200mA-h pack



DELUXE CANVAS POLISHER BAG

FLEX POLISHER ACCESSORIES

COMPATIBLE WITH:

- The Finisher (XFE 7-15 150)
- The Beast (XC 3401 VRG)
- The Rotary Polisher (PE 14-2 150)
- The Kompakt 3 Polisher (PE8-4 80)
- The Lightweight Rotary Polisher (L 3403 VRG)

\$41.98 **FLEX991100**



MULTI-PURPOSE CANVAS POLISHER BAG

FLEX POLISHER ACCESSORIES

COMPATIBLE WITH:

- The Finisher (XFE 7-15 150)
- The Beast (XC 3401 VRG)
- The Rotary Polisher (PE 14-2 150)
- The Kompakt 3 Polisher (PE8-4 80)
- The Lightweight Rotary Polisher (L 3403 VRG)

\$32.65 **FLEX992100**



DOUBLE ADAPTER

FLEX POLISHER ACCESSORIES

- 5/8" x 11" double adapter for rotary polishers

\$13.99 **FLEX951125**



IMPORTANT

- Batteries are classified as hazardous materials in transit.
- Products containing lithium ion batteries only ship ground to continental US and Canada.
- Not eligible for expedited services.



CYCLO® POLISHERS & PADS

MODEL 5 MARK II DUAL-HEAD ORBITAL POLISHER

CYCLO TOOLMAKER



- Features a metal body and attractive powder coating! Its synchronized, dual orbiting heads mimic the patterns made when hand polishing. Plus, it's balanced, so you don't have to deal with unnecessary vibration and swirl marks.
- The Cyclo polisher can deoxidize gel coats, scrub non-skid surfaces, restore luster to vinyl, and even scrub interior upholstery! You can use it on cars, trucks, RVs, and boats. Some have even found it useful for tile/grout cleaning, hockey arena board cleaning, metal polishing, and headlight restoration! Simply choose your appropriate accessories (sold separately) and tackle the job at hand. Features a 1-year warranty.
- **MOTOR:** Alternating current, semi-enclosed 24-bar commutator, Output: 1/3 HP
- **HOUSING:** Heavy-duty powder coated cast aluminum
- **POWER SUPPLY:** 115V, 60 Hertz, 220 Watts
- **WEIGHT:** 6.5 lb.
- **ELECTRIC CORD:** 10' length, 16 ga/2SJTOW
- **SPEED:** 3000 orbits/minute
- **HEAD DIAMETER:** Clockwise/4"

\$305.88 CY80010 PADS SOLD SEPARATELY

PARTS & ACCESSORIES

CYCLO TOOLMAKERS

- **\$5.31** CY30500 Carbon Brush/Spring/Dead Stop
- **\$10.07** CY60010 Nylon Drive Gear for Model 5 Pro

CYCLO CAR WASH KIT

CYCLO TOOLMAKERS

- All of the top pads for the car wash detailing environment!
- INCLUDES THE FOLLOWING PADS:**
 - (4) Yellow Cutting Pads • (8) Green Polishing Pads • (4) Blue Polishing Pads • (4) White Finishing Pads

\$59.50 CYKIT01



4 YELLOW CUTTING PADS

CYCLO TOOLMAKERS

- A firm, versatile pad that can be used on everything from compounding and scratch removal to applying paint cleaners and polishes

RECOMMENDED APPLICATIONS INCLUDE:

- Paint Polish/Cleaner, Paint Compound, Paint Deox, Paint Scratch Remover

\$16.70 CY72135



4 GREEN POLISHING PADS

CYCLO TOOLMAKERS

- A more aggressive pad than the white or blue pads. The pore density makes it perfect for polishing and removing light oxidation for a stunning shine

RECOMMENDED APPLICATIONS INCLUDE:

- Sealant, Paint Polish, Paint Cleaner, Metal Sealant

\$14.58 CY72120



4 BLUE POLISHING PADS

CYCLO TOOLMAKERS

- Perfect for light polishing on any surface. Use with wax and polish for a fine gloss finish or to remove swirl marks

RECOMMENDED APPLICATIONS INCLUDE:

- Paint/Metal Sealant, Paint Polish, Paint Cleaner, Final Wax Buff, Wax Application

\$14.58 CY72115



4 WHITE FINISHING PADS

CYCLO TOOLMAKERS

- This superfine pad is used in final buffing, after polishing with other pads is complete. Excellent for applying sealants and buffing out wax

RECOMMENDED APPLICATIONS INCLUDE:

- Extreme Shine, Final Wax Buff, Wax Application, Sealant, Metal Sealant

\$14.58 CY72110



ATTACHMENTS

CYCLO ATTACHMENTS & PADS

- Only Genuine Cyclo pads have been designed to work precisely with their polishers. Their foam pads are 4 inches in diameter and made from high quality, reticulated polyester urethane foams. They are durable, long-lasting and provide top performance. And, they offer a variety of textures – ranging from compounding, cutting, scrubbing, polishing, cleaning, waxing, sealing and finessing – to meet the exacting needs of the professional detailer.



PRICE	PART #	DESCRIPTION	COLOR	QTY
\$36.44	CY76830	Softer Shampoo Brush	Aqua	2 Pack
\$18.75	CY72145	Compounding Foam Polishing Pad	Orange	4 Pack
\$35.29	CY76810	Ultra Soft Shampoo Brush	Gray	2 Pack
\$14.58	CY72120	Foam Polishing Pad w/Velcro	Green	4 Pack
\$16.70	CY72135	Foam Cutting Pad w/Velcro	Yellow	4 Pack

PRICE	PART #	DESCRIPTION	COLOR	QTY
\$36.55	CY76840	Soft Shampoo Brush	White	2 Pack
\$36.55	CY76870	Stiff Scrub Brush	Black	2 Pack
\$36.91	CY79112	ProGuard Orbital Backing Plate	Blue/Black	2 Pack
\$14.58	CY72115	Foam Polishing Pad	Blue	4 Pack

MEGIAR'S® POLISERS



The MT300 is equipped with A Digital Torque Management system TO ensures proper torque to help maintain load speed and provide you with outstanding results.

MEGIAR'S® MT300 PROFESSIONAL DUAL ACTION POLISHER

MEGIAR'S DETAILING POLISERS

- Meguiar's MT300 Professional Dual Action Polisher is Meguiar's NEW dual action polisher with plenty of power to get those swirls and light scratches out.
- With Digital Torque Management you're sure to have the power you need each and every time. A well balanced machine with the comfort for those long jobs.
- Digital Torque Management (DTM) - Electronically adjusts torque needed to maintain set speed level
- Multi-Position D Handle - Improves comfort & control for all skill levels
- Billet Counter Weight with Triple Bearing Design - Ensures smooth precision balance with increased durability
- Thumb Adjustable Speed Dial - Wide 3000-7500 OPM Speed Range. Allows for faster compounding & superior final polishing
- Ergonomic Design - Perfect combination of form and function
- Soft Start - Provides easy control when turning on machine
- Replaceable Brushes - Easily accessible side ports for fast & easy brush changes
- Safe Universal 8mm Throw - Great for compounding, polishing and waxing on large surfaces as well as in tight contours.
- Wattage: 500

\$263.07 MGD300

MEGIAR'S® ACTION PLATES & DISCS



BACKING PLATE MEGIAR'S ACTION PLATES & DISCS

- For Dual Action Polisher
- 5" or 6"

\$22.15	MGDBP5	5"
\$22.15	MGDBP6	6"



CUTTING DISC MEGIAR'S ACTION PLATES & DISCS

- For Dual Action Polisher
- 5" or 6"

\$11.04	MGDFC5	5"
\$12.43	MGDFC6	6"



POLISHING DISC MEGIAR'S ACTION PLATES & DISCS

- For Dual Action Polisher
- 5" or 6"

\$11.04	MGDFP5	5"
\$12.43	MGDFP6	6"



FINISHING DISC MEGIAR'S ACTION PLATES & DISCS

- For Dual Action Polisher
- 5" or 6"

\$11.04	MGdff5	5"
\$12.43	MGdff6	6"

New!



POLISHING DISC MEGIAR'S ACTION PLATES & DISCS

- For Dual Action Polisher

\$23.54	MGDMC6	6"
----------------	---------------	----

New!



FINISHING DISC MEGIAR'S ACTION PLATES & DISCS

- For Dual Action Polisher

\$23.54	MGDMF6	6"
----------------	---------------	----



MYTEE® EXTRACTORS & DETAILING EQUIPMENT



80-120 PREP CENTER S™ MYTEE DETAILING EQUIPMENT



- The Prep Center S series offers the ultimate cleaning power, organization and versatility for your automotive detailing challenges. The Prep Center S can do the job of multiple units.
- Multiple Chemical Dispenser: Three bottles powered by a shop air compressor with coiled hoses and adjustable nozzles.
- Features heated extraction, vacuuming, exterior drying and tool organization

INCLUDES:

- 25' Vacuum and Solution Hose
- Air Lite™ 4" Upholstery Tool
- 25' Dry Vacuum Hose
- Dry Vacuum Claw
- Dry Vacuum Crevice
- Exterior drying tool

CORD	25'
AMP DRAW	20
WEIGHT	210 lbs.

DIMENSIONS	31" x 19" x 53½"
HEATER	1200W - 210° max.

CALL FOR PRICING MY80120

80-120 PREP CENTER S™ REPLACEMENT PARTS

\$116.99	VAL6765	Vac Motor	\$248.00	MYA907	Heater
\$169.73	SF8000812288	Pump	\$14.85	MYPE515	2 Position Switch

BUNDLE AVAILABLE!



HP120 GRAND PRIX™ AUTOMOTIVE HEATED DETAIL EXTRACTOR MYTEE EXTRACTORS



INCLUDES:

- 15' vacuum & solution hose combo
- Heatguard housewrap, made of neoprene wetsuit material
- Air Lite™ 4" Upholstery Tool

BODY	Roto-molded polyethylene						
SOLUTION TANK	10-Gallon						
RECOVERY TANK	9-Gallon						
VACUUM	Single 3 stage low amp						
CFM	100	H2O	130"	PSI	120	GPM	1.3

CORD	25'
AMP DRAW	20
WEIGHT	120 lbs.
DIMENSIONS	28" x 18½" x 39"
HEATER	1200W inline - 210° max.

CALL	MYHP120	-
	MYHP120-B	Bundle: 1 qt. Mytee System Maintainer (3601) • 1 gal. Kleen-Shine All-Purpose Soap (KS1091) • 1 gal. Kleen-Shine Extractor Defoamer Additive (KS1118) • 8700 Crevice Tool • 8390-EZ 10" Jet Carpet Cleaning Wand

REPLACEMENT PARTS FOR HP120

\$104.00	MYH8501	15' x 1¼" Vacuum and solution hose combo w/ Cuff-Lynx 2" female vacuum hose connector
\$14.85	MYA935	7½" X ½" Solution hose with ¼"MPT X ½"MPT fittings
\$25.16	MYAH156	6½" Solution hose
\$91.44	VMK200	120V Motor
\$91.44	VMK200	Vacuum Motor
\$164.59	ATP1060	120 PSI demand pump, 115V

\$17.34	MYPE573	Thermostat, 200 °F, ¼"
\$18.87	MYPE574	Thermostat, 310 °F, ¼"
\$12.40	MYG061	Solution tank cover
\$38.81	MYG090	7" Vacuum tank lid
\$1.05	MYH219	½" Black oxide axle cap
\$27.41	MYH225	1½" Drain valve
\$14.85	MYPE515	2 Position rocker switch
\$62.91	MYE531	25' Power cord, 12/3

VMK200 **MYH225**

BUNDLE AVAILABLE!



HP60 SPYDER™ AUTOMOTIVE HEATED DETAIL EXTRACTOR MYTEE EXTRACTORS



INCLUDES:

- 15' vacuum & solution hose combo
- Heatguard housewrap, made of neoprene wetsuit material
- Air Lite™ 4" Upholstery Tool

BODY	Roto-molded polyethylene						
SOLUTION TANK	Approx. 5 gallon capacity						
VACUUM TANK	Approx. 5 gallon capacity						
VACUUM	Single 3 stage low amp						
CFM	100	H2O	130"	PSI	120	GPM	1.3

CORD	25' 12/3
AMP DRAW	20
WEIGHT	69 lbs.
DIMENSIONS	25" x 15½" x 29½"
HEATER	1200W - 210° max.

CALL	MYHP60	-
	MYHP60-B	Bundle: 1 qt. Mytee System Maintainer (3601) • 1 gal. Kleen-Shine All-Purpose Soap (KS1091) • 1 gal. Kleen-Shine Extractor Defoamer Additive (KS1118) • 8700 Crevice Tool • 8390-EZ 10" Jet Carpet Cleaning Wand

REPLACEMENT PARTS FOR HP120 & HP60

\$116.99	VAL6765	Vac Motor
\$169.73	SF8000812288	Pump
\$248.00	MYA907	Heater

\$14.85	MYPE515	2 Position Switch
\$27.41	MYH225	Drain Valve

MYTEE® EXTRACTORS & DETAILING EQUIPMENT



EXTRACTOR STARTER CHEMICAL KIT

MYTEE EXTRACTORS

INCLUDES:

- MY3601 Mytee System Maintainer: Keep your lines free of hard water and chemical build up with this specially-formulated system maintainer - helps to prevent chemical build-up through regular usage.
- KS1091 Kleen-Shine All Kleen All-Purpose Cleaner: An all-purpose formula capable of cleaning virtually any automotive surface, including carpeting.
- KS1118 Kleen-Shine Defoamer: A concentrated extractor additive that kills foam in an extractor recovery tank and protects extractor motor from damage.

28.99	KRK2500	\$48.99	KRK2500-1	Includes all, plus KS2115 and S3364012
--------------	----------------	----------------	------------------	--

BUNDLE AVAILABLE!



8070 MYTEE® LITE HEATED CARPET EXTRACTOR

MYTEE EXTRACTORS

- Hot water extractor in a four-gallon body. Great for spotting, upholstery cleaning, automotive detailing, and more.
- Do everything you can do with a full size unit. All in a compact, lightweight package. Perfect for quick jobs - also great as a rental unit.

INCLUDES:

- Storage Basket
- Air Lite™ 4" Upholstery Tool
- Heatguard hosewrap
- A110 Drain Hose
- 15' vacuum solution hose
- Included handle with cord wrap

BODY	Roto-molded polyethylene						CORD	25' 12/3	
SOLUTION TANK	4 gallon capacity						AMP DRAW	19	
VACUUM TANK	4 gallon capacity						WEIGHT	60 lbs.	
VACUUM	Single 3 Stage						DIMENSIONS	18" x 12" x 28½"	
CFM	120	H2O	130"	PSI	120	GPM	1.3	HEATER	1,000W - 210° max.

CALL	MYA8070	-
	MYA8070-B	Bundle: 1 qt. Mytee System Maintainer (3601) • 1 gal. Kleen-Shine All-Purpose Soap (KS1091) • 1 gal. Kleen-Shine Extractor Defoamer Additive (KS1118) • 8700 Crevice Tool



MYTEE® REPLACEMENT PARTS FOR 8070 MYTEE® LITE

\$106.38	VMK151MP	Replacement Vac Motor - 120V	\$185.33	MYA901	Heater
\$169.73	SF8000812288	120 PSI Pump	\$27.41	MYH225	Drain Valve



S-300H TEMPO™ HEATED EXTRACTOR

MYTEE EXTRACTORS

- Easy to fill and empty. Perfect for the occasional job or for the serious auto detailer.
- One of the most powerful two-stage vacuum motors in its class, producing 85" of water lift and reducing drying times
- Powerful 600 watt heater
- Compact tank capacity of 1 gallon and weighs only 28 lbs. making it easy to transport
- Convenient transport handle and wheels

INCLUDES:

- Air Lite™ 4" Upholstery Tool
- 8' vacuum and solution hose combo
- Heatguard hose wrap
- 25' power cord

CALL	MYS300H	Extractor only
	MYS300H-B	Bundle Includes: 1 quart Mytee System Maintainer, 1 gallon Kleen-Shine All-Purpose Soap, 1 gallon Kleen-Shine Extractor Defoamer Additive



S-300 TEMPO™ UPHOLSTERY SPOTTER

MYTEE EXTRACTORS

- Easy to fill and empty. Perfect for the occasional job or for the serious auto detailer.
- One of the most powerful two-stage vacuum motors in its class, producing 85" of water lift and reducing drying times
- Compact tank capacity of 1 gallon and weighs only 20 lbs. making it easy to transport
- Water-resistant switches protect against dust and water intrusion while a lighted power cord indicates the cord has power

INCLUDES:

- Air Lite™ 4" Upholstery Tool
- 8' vacuum and solution hose combo
- Heatguard hose wrap
- 25' power cord

CALL	MYS300	Extractor only
	MYS300-B	Bundle Includes: 1 quart Mytee System Maintainer, 1 gallon Kleen-Shine All-Purpose Soap, 1 gallon Kleen-Shine Extractor Defoamer Additive



MYTEE® EXTRACTORS & DETAILING EQUIPMENT

1000DX-200 & 1001DX-200 SPEEDSTER® DELUXE CARPET EXTRACTORS

MYTEE STEAMERS AND EXTRACTORS

- 10" foam-filled wheels and 5" locking casters for easy mobility around the job site or even stairs.
 - Waist-high switches and bucket-high drains
- INCLUDES:** Detachable power cords, 2" Cuff-Lynx™ hose adapter and 2" to 1½" Cuff-Lynx™ reducer and drain elbow

BODY	Roto-molded polyethylene						
SOLUTION TANK	10 gallon capacity						
VACUUM TANK	9 gallon capacity						
VACUUM	Dual 3 Stage						
CFM	200	H2O	130"	PSI	220	GPM	1.35

CORD	1000DX - single cord 1001DX - dual cord
AMP DRAW	Cord One: 20 amps
SHIP WEIGHT	120 lbs.
SHIPPING DIMENSIONS	30" x 20" x 47"
PRODUCT DIMENSIONS	28" x 18½" x 39"

CALL	MY1000DX-200	Standard
	MY1001DX-200	HEATED

EFFICIENT 2,000-WATT, MAXIMUM 200° HEATER AND TWO 3-STAGE LA (LOW AMP) MOTORS

1003DX SPEEDSTER® DELUXE HEATED CARPET EXTRACTOR

MYTEE STEAMERS AND EXTRACTORS

- 10" foam-filled wheels and locking casters for easy mobility around the job site or even stairs.
 - Waist-high switches and bucket-high drains
- INCLUDES:** Detachable power cords, 2" Cuff-Lynx™ hose adapter and 2" to 1½" Cuff-Lynx™ reducer and drain elbow

BODY	Roto-molded polyethylene						
SOLUTION TANK	10 gallon capacity						
VACUUM TANK	9 gallon capacity						
VACUUM	Dual 3 Stage						
CFM	200	H2O	130"	PSI	Adj. 0-500	GPM	1.5

CORD	Dual 50' 12/3
AMP DRAW	Cord One: 20 • Cord Two: 18
SHIP WEIGHT	150 lbs. (pallet not included)
SHIPPING DIMENSIONS	30" x 20" x 47"
PRODUCT DIMENSIONS	28" x 18.5" x 39"

CALL	MY1003DX
-------------	-----------------

HEATED MODEL - 1600 WATT - 210 DEGREE MAX

1005LX SPEEDSTER® DELUXE CARPET EXTRACTOR

MYTEE STEAMERS AND EXTRACTORS

- 10" foam-filled wheels and locking casters for easy mobility around the job site or even stairs.
 - Waist-high switches and bucket-high drains
- INCLUDES:** Detachable power cords, 2" Cuff-Lynx™ hose adapter and 2" to 1½" Cuff-Lynx™ reducer and drain elbow

BODY	Roto-molded polyethylene						
SOLUTION TANK	10 gallon capacity						
VACUUM TANK	9 gallon capacity						
VACUUM	Dual Mytee Exclusive LX™ Vacuum Motors						
CFM	225-250	H2O	182"	PSI	Adj. 0-500	GPM	1.5

CORD	Dual 50' 12/3
AMP DRAW	Cord One: 20 • Cord Two: 15
SHIP WEIGHT	140 lbs. (pallet not included)
SHIPPING DIMENSIONS	30" x 20" x 47"
PRODUCT DIMENSIONS	28" x 18½" x 39"

CALL	MY1005LX
-------------	-----------------

7303LX AIR HOG™ VACUUM BOOSTER

MYTEE STEAMERS AND EXTRACTORS

- Two machines in one - The Air Hog™ can be used as a vacuum booster as well as a stand-alone extractor!
- FEATURES:** Dual Mytee Exclusive LX™ Vacuum Motors, 225-250 CFM, 182" water lift
INCLUDES: Dual 25' extension cords, 2" x 2" male Cuff-Lynx™, 2" x 2" female Cuff-Lynx™, 2" x 1½" Cuff-Lynx™

TANK	7-gallon		
VACUUM	Dual Mytee Exclusive LX™ Vacuum Motors		
CFM	225-250		
H2O	182"		
PUMP-OUT	Diaphragm	GPM	3.3

AMP DRAW	Cord 1: 15 amps, Cord 2: 15 amps
POWER CORD	Dual 25' 12/3
SHIPPING WEIGHT	70 lbs.
SHIPPING DIMENSIONS	30½" x 14½" x 37"
PRODUCT DIMENSIONS	25" x 14" x 27"

CALL	MY7303LX
-------------	-----------------

DO NOT USE WITH A TRUCK MOUNT



MYTEE® EXTRACTORS & DETAILING EQUIPMENT



T-REX™ TOTAL ROTARY EXTRACTOR

MYTEE STEAMERS AND EXTRACTORS

- 15" Cleaning path
- 6 vacuum slots
- Clear swivel tube
- Lightweight
- 80 lbs.
- 60-160 RPM
- High solution flow; 6 jets
- Amp Draw: 8
- 1 HP
- 115/240V
- Ambidextrous safety switch – prevents damage to nearby objects
- Elevated, easy handle adjustment
- Pigtail with detachable 25' 16/3 lighted power cord

INCLUDES:

2" Cuff-Lynx™ hose connection with retainer, storage cover, 15" stainless steel cleaning head, 4 oz. bottle of PTFE lubricant

- **MYA105 HOSE NOT INCLUDED**

CALL MYTREX



T-REX™ JR. ROTARY EXTRACTOR

MYTEE STEAMERS AND EXTRACTORS

- 12" Cleaning path
- 4 vacuum slots
- Clear swivel tube
- Lightweight
- 53 lbs.
- 80-180 RPM
- High solution flow; 4 jets
- Amp Draw: 3.8
- 0.5 HP
- 115/240V
- Ambidextrous safety switch – prevents damage to nearby objects
- Elevated, easy handle adjustment
- Pigtail with detachable 25' 16/3 lighted power cord

INCLUDES:

2" Cuff-Lynx™ hose connection with retainer, storage cover, 12" stainless steel cleaning head, 4 oz. bottle of PTFE lubricant

- **MYA105 HOSE NOT INCLUDED**

CALL MYTREX-JR



240-120 MYTEE® HOT TURBO

MYTEE STEAMERS AND EXTRACTORS

- 2400-watt portable heater that can be hooked up to any cold water extractor to produce hot water
- Switches allow you to select either 600, 1200, 1800, or 2400 watts of heat for 210 degree maximum heat

AMPS	5A, 10A, 15A, or 20A - four switches
MAX. PRESSURE	1,500+ PSI
MAX. TEMP	210 Degree
MAX. WATTS	2400 (4 x 600W)
POWER CORD	Single 25' 12/3
SHIPPING DIMENSIONS	18¾" x 7" x 8½"
SHIPPING WEIGHT	30w lbs., pallet not included
PRODUCT DIMENSIONS	11½" x 12½" x 11"

CALL MY240-120

HEATED MODEL

Contains cUL listed components



ECO-17 PRO ORBITAL ALL-SURFACE FLOOR MACHINE

MYTEE STEAMERS AND EXTRACTORS

- Mytee's Orbital All Surface Floor Machines are not just your average orbital floor machines. They're the only ones in the industry with a 1.5 horsepower motor, powerful enough to overcome surface tension. That means the job gets done faster so you get paid faster. Perfect for: carpet encapsulation cleaning, tile & grout cleaning, sanding, scrubbing, and polishing concrete, stone, and vinyl flooring.

FEATURES: 17" cleaning path with built-in 4 gallon shampoo tank, 60 PSI solution pump, dual front-mounted spray jets - low drift, smooth operating with low vibration design, 10" non-marking foam-filled wheels for increased maneuverability over stairs, curbs, etc.

INCLUDES: 17" pad driver and 50' twist-lock power cord

MOTOR	1.5 HP
PUMP	Diaphragm spray pump
SOLUTION TANK	4-gal. capacity with faucet fill hose & drain cap
LEVERS	Stainless steel
DECK PLATE	Stainless steel
POWER CORD	50' twist-lock
SHIPPING WEIGHT	140 lbs. (does not include pallet weight)
PRODUCT WEIGHT	110-120 lbs.

CALL MYECO17

Contains cUL listed components



8390-EZ STAINLESS STEEL EXTRACTOR WAND

MYTEE STEAMERS AND EXTRACTORS

- 10" Polished aluminum head
- Straight tube
- Easy-touch valve
- Jets: Single
- Rated to: 1200 PSI
- Tube Diameter: 1.5"
- Ergonomic grip • Shipping Weight: 9 lbs.

CALL MY8390-EZ



MYTEE® EXTRACTORS, DETAILING EQUIPMENT & MORE

LTD12-LX SPEEDSTER® CARPET EXTRACTOR

MYTEE STEAMERS AND EXTRACTORS

- 10" foam-filled wheels and locking 4" casters for easy mobility around the job site or even stairs
 - Waist-high switches and bucket-high drains, waist-high prime valve with recovery tank rinse hose
- INCLUDES:** 2" Cuff-Lynx™ coupler swivel (2" female x 2" female vac hose) and 2" to 1½" Cuff-Lynx™ reducer (2" female x 1½" female), drain elbow, 5 qt. bottle for chemical metering

BODY	Roto-molded polyethylene			CORD	Detachable Dual 50' 12/3
SOLUTION TANK	Approx. 11 gallon capacity			AMP DRAW	Cord One: 14 amps Cord Two: 20 amps
VACUUM TANK	Approx. 11 gallon capacity			SHIP WEIGHT	188 lbs., pallet not included
VACUUM	Dual 3 Stage			SHIPPING DIMENSIONS	37¼" x 21½" x 50½"
CFM	225-250	H2O	145"	PSI	Adjustable 50-1200
PUMP GPM	2.2		PUMP	Pumptec Piston Pump	
PUMP OUT GPM	3.3				

CALL MYLTD12

LTD5-LX SPEEDSTER® LTD CARPET EXTRACTOR

MYTEE STEAMERS AND EXTRACTORS

- Water resistant switches protect against dust and water entry
 - Locking casters provide a stable base that won't move by accident
- INCLUDES:** 2" Cuff-Lynx™ coupler swivel (2" female x 2" female vac hose) and 2" to 1½" Cuff-Lynx™ reducer (2" female x 1½" female), drain elbow, 5 qt. bottle for chemical metering

BODY	Roto-molded polyethylene			CORD	Detachable Dual 50' 12/3
SOLUTION TANK	Approx. 11 gallon capacity			AMP DRAW	Cord One: 20 amps Cord Two: 14 amps
VACUUM TANK	Approx. 11 gallon capacity			SHIP WEIGHT	160 lbs., pallet not included
VACUUM	Dual Mytee Exclusive LX™ Vacuum Motors			SHIPPING DIMENSIONS	37¼" x 21½" x 50¾"
CFM	225-250	H2O	182"	PSI	Adjustable to 500
PUMP GPM	1.5		PUMP	Pumptec Piston Pump	
PUMP OUT GPM	3.3				

CALL MYLTD5-LX

LTD3 SPEEDSTER® HEATED CARPET EXTRACTOR

MYTEE STEAMERS AND EXTRACTORS

- 10" foam-filled wheels and locking casters for easy mobility around the job site or even stairs.
 - Waist-high switches and bucket-high drains, waist-high prime valve with recovery tank rinse hose
- INCLUDES:** 2" Cuff-Lynx™ coupler swivel (2" female x 2" female vac hose) and 2" to 1.5" Cuff-Lynx™ reducer (2" female x 1.5" female), drain elbow, 5 qt. bottle for chemical metering

BODY	Roto-molded polyethylene			CORD	Detachable Dual 50' 12/3
SOLUTION TANK	Approx. 11 gallon capacity			AMP DRAW	Cord One: 20 amps Cord Two: 20 amps
VACUUM TANK	Approx. 11 gallon capacity			SHIP WEIGHT	180 lbs., pallet not included
VACUUM	Dual 3 Stage			SHIPPING DIMENSIONS	37 1/4" x 21 1/2" x 50 3/4"
CFM	200	H2O	130"	PSI	Adjustable to 500
PUMP GPM	1.5		PUMP	Pumptec Piston Pump	
PUMP OUT GPM	3.3				

CALL MYLTD3

HEATED MODEL - 1600 WATT - 210 DEGREE MAX

7000LX HEAVY DUTY FLOOD HOG™ FLOOD EXTRACTOR

MYTEE STEAMERS AND EXTRACTORS

- Professional, portable flood extractor designed specifically for large flood restoration jobs
- FEATURES:** Dual circuit indicator light & tone, 10" foam-filled wheels and 4" locking casters, built-in stainless steel debris filter
INCLUDES: 50' x 1.5" pump-out hose, 2" to 1.5" Cuff-Lynx™ reducer

RECOVERY TANK	12 gallon			CORD	Dual 50' 12/3
VACUUM	Dual Mytee Exclusive LX™ Vacuum Motors			AMP DRAW	Cord One: 18 amps Cord Two: 13 amps
WATER LIFT	182"			SHIP WEIGHT	147 lbs., pallet not included
PUMP OUT	66 GPM			SHIPPING DIMENSIONS	30" x 19" x 50"
DEBRIS FILTER	Built-in stainless steel			PRODUCT DIMENSIONS	29" x 17.5" x 35"

CALL MY7000LX





MYTEE® EQUIPMENT & ACCESSORIES



8904 T-HANDLE STYLE 1½" SPINNER® TILE & GROUT CLEANING TOOL

MYTEE STEAMERS AND EXTRACTORS

FEATURES: 1.5" port that can be attached to a truckmount, high-pressure extractor, or pressure washer, removable brush ring with built-in vacuum relief for instant drying, low profile for cleaning under toe kicks and hard-to-reach areas, rebuildable flange mounted swivels, durable carbide seals, replaceable skirt brush, lightweight and scratch-resistant nylon handle, tested at 500 PSI, recommend at least 800 PSI for operation.

BODY	Roto-molded polyethylene	JETS	Dual
CLEANING PATH	12"	JET SIZE	1502
TUBE CONSTRUCTION	Stainless Steel	BRUSH	12" Replaceable
TUBE DIAMETER	1½"	SHIPPING WEIGHT	20 lbs.
PSI	800-3000	PRODUCT DIMENSIONS	19" x 16" x 49"
SWIVEL	Carbide	SHIPPING DIMENSIONS	23" x 14" x 52"

CALL MY8904

8400GT MYTEE DRY™ GT ALL METAL UPHOLSTERY TOOL

MYTEE ACCESSORIES

FEATURES:

- Sleek, triggerless design reduces fatigue and hand strain
- 22 individual spray orifices ensures an even clean
- Dual PTFE glide slots allow for cleaning in both directions and leaves upholstery drier for rapid turnaround
- Black, powder-coated, all-metal housing withstands daily use for years to come
- Made from a lightweight alloy
- Clear sight window allows you to see dirt and grime being extracted
- Easy-adjust flow valve lets you control the flow level or stop it completely
- Machine end shut-off valve with an inline mesh filter built-in
- Pre-installed on an extra flexible 15 ft. vacuum and solution hose combo

INCLUDES:

- Pack of 2 comfort grips - one black and one blue
- 2" to 1.25" Cuff-Lynx™ reducer
- 1.5" vinyl cuff
- 1.5" barbed coupler
- Heatguard™ hose wrap



CALL MY8400GT 

AIR LITE UPHOLSTERY TOOL

MYTEE ACCESSORIES

- Constructed of crack-resistant, clear plastic so you can see the dirt being extracted
- 4" Positive Ventilation glide, clear construction, comfort grip spray lever, lightweight at only 1.25 lbs.

CALL MY8400P



MYTEE® HEATGUARD VACUUM & SOLUTION HOSE WRAPS

MYTEE ACCESSORIES

- Made from Closed Cell Neoprene (wet-suit material) that guards you from heated solution lines and quick disconnects. These are much more efficient and reliable than your basic Velcro straps.
- Fits on 1¼", 1½", and 2" hoses
- Comes in a Pack of 5

CALL MYG079



2" F x M STARTER

MYTEE ACCESSORIES

- Allows you to easily change your extractor hose cuff from female to male. This male starter is made from high-quality vinyl that is crack-resistant and longer lasting than standard plastic starters.
- Durable vinyl - resistant to breaks, splits and cracks
- Slim profile
- For use with standard hoses

CALL MYH135V



WIRE HOSE HANGER

MYTEE ACCESSORIES

- Black formed wire hanger for hose.
- Optional addition to all Mytee machines (excludes Prep Center).

CALL MYH375

CUTIES™ REUSABLE QD SAFETY COVERS

MYTEE ACCESSORIES

- Pack of 2
- Cuties are protective caps that attach to QDs, making them safe to touch - no more burns!

CALL MYP590



STAINLESS STEEL FLOAT SWITCH RETROFIT KIT

MYTEE ACCESSORIES

- Stainless steel float switch retrofit kit for Speedster®, LTD Speedster®, and Breeze™ units
- INCLUDES:**
- 2x E373 float switches
 - 2x B103 brass elbows
 - 1x B113 brass tee
 - 2x H211 washers
 - 1x B107 brass nipple

CALL MYA128





MR-100 PRIMO

VAPAMORE STEAM CLEANING SYSTEMS

- Perfect for carpet and upholstery
- 60 minutes of operation per tank
- 1.6-liter stainless steel boiler with a 1500W water heater
- Solenoid operated steam control with adjustable steam output
- Produces 210°F - 220°F steam to clean and sanitize without chemicals
- Removes dirt, grease, grime and stains
- Kills germs, dust mites, bed bugs (extremely effective), mold and mildew

\$349.00 VMR100

FREE SHIPPING

LIFETIME WARRANTY



MR-1000 FORZA COMMERCIAL STEAMER

VAPAMORE STEAM CLEANING SYSTEMS

- The all new Forza features an easy to remove U shape handle and removable parts storage basket so fitting the machine in tight spaces is no problem
- Produces 270°F - 280°F steam
- 90 PSI steam pressure
- 50 accessories & attachments
- Over 3 gallons of on-board water capacity
- Continuous flow, no down time
- 1900 Watt heating element
- Computer-controlled operation
- Removable u handle & parts basket
- Commercial grade construction
- Adjustable steam output

\$1,599.00 VMR1000

FREE SHIPPING

LIFETIME WARRANTY



MR-750 OTTIMO HEAVY DUTY STEAM CLEANER

VAPAMORE STEAM CLEANING SYSTEMS

- Produces 270°F - 280°F steam with 75 PSI steam pressure
- 4-litre stainless steel boiler (largest available), 1600 watt heater with dual thermostat operation
- Made from commercial-grade, powder-coated steel
- 3 hour work time for larger jobs
- Water level indicator dipstick
- Computer controlled operation
- Small, lightweight machine is easy to move, store and ready to tackle any job

\$899.00 VMR750

FREE SHIPPING

LIFETIME WARRANTY



VAPAMORE MR-75 AMICO HAND HELD STEAMER

VAPAMORE STEAM CLEANING SYSTEMS

- Produces 210°F, cleaning and sanitizing without chemicals
- Kills germs, dust mites, bed bugs, mold and mildew
- Largest selection of accessories
- Removes dirt, grease, grime and stains
- Portable handheld design weighing only 3.5 lbs
- 1000W water heater

\$99.00 VMR75

FREE SHIPPING

LIFETIME WARRANTY

EXTRACTORS & STEAMERS



THRESHER® EXTRACTORS

DIAMOND LUSTRE INT, LTD. EXTRACTORS

- This machine is intended for commercial use
- 100 PSI solution demand pump
- 15' solution and 15' vacuum hose Included
- Instant heat (150° or 200° F)
- Dual cord - Thresher-2 (200° F)
- Powerful 3 stage vacuum motor (150" lift)
- 13-gallon solution/ 13-gallon recovery tank
- Detailing hand wand included
- Single cord - Thresher-1 (150° F)

\$2,111.76	EXTHRESHER-1	Single Cord Model	150° F
\$2,152.94	EXTHRESHER-2	Dual Cord Model	200° F

EXTRACTOR PARTS & ACCESSORIES



STAINLESS STEEL FLOOR WAND

EXTRACTOR PARTS & ACCESSORIES

\$253.51 EXPSSFW



STAINLESS STEEL HAND WAND

EXTRACTOR PARTS & ACCESSORIES

\$95.24 EXPSSHW



BRASS TRIGGER VALVE ASSEMBLY

EXTRACTOR PARTS & ACCESSORIES

\$24.64 EXPV1245



VACUUM MOTOR

EXTRACTOR PARTS & ACCESSORIES

\$87.77 VMK6765



CREVICE WAND WITH SPRAYER

EXTRACTOR PARTS & ACCESSORIES

- Stainless steel

\$92.26 EXPSSCT-1



12" SOLUTION HOSE FOR HAND WAND

EXTRACTOR PARTS & ACCESSORIES

\$17.68 EXPHOSE-12



VACUUM MOTOR GASKET

EXTRACTOR PARTS & ACCESSORIES

- 5" OD, 2" ID

\$1.25 VAGS036



15' VACUUM HOSE

EXTRACTOR PARTS & ACCESSORIES

\$24.82 EXPVHOSE



VEEJET NOZZLE FOR SPRAY HEAD

EXTRACTOR PARTS & ACCESSORIES

\$12.20 EXPH27



FEMALE QUICK DISCONNECT

EXTRACTOR PARTS & ACCESSORIES

- Brass

\$16.91 EXPH24



MALE QUICK DISCONNECT

EXTRACTOR PARTS & ACCESSORIES

- Brass

\$10.06 EXPH21

KLEENRITE® EDGE KLEENRITE EXTRACTORS

- The EDGE® 3 has an individual solution and waste tanks (1.1 gallon solution/11.5 gallon waste), a large opening on the waste tank with a rotationally molded vacuum connection lid. The solution and vacuum connection are on the front of the machine and the waste discharge is on the rear of the machine.
- All machines in the EDGE® Series offer you many choices in pump, vacuum and heater configurations. Preheat capability, which allows you to heat the solution tank prior to cleaning and vacuum silencing, making your EDGE® very quiet (72 db), are available depending on the model you choose. All units include 25' of solution and vacuum hose and 25' of power cord(s).

KLEENRITE® EDGE 200 PSI KLEENRITE® EXTRACTORS

- **VACUUM:** 3 stage
- **HEATER:** 1200 watt inline
- **CORD:** Single attached
- **CASTERS:** Locking
- **HOSES:** 25' (¼" solution & 1¼" vacuum)
- **DETAIL TOOL:** Stainless steel
- Hose bag

\$2,781.10 KRE3100

KLEENRITE® EDGE 120 PSI KLEENRITE® EXTRACTORS

- **VACUUM:** 3 stage
- **HEATER:** 1000 & 1750 watt inline
- **TANK:** Stainless steel
- **CORD:** Single attached
- **CASTERS:** Locking
- **HOSES:** 25' (¼" solution & 1½" vacuum)
- **DETAIL TOOL:** Stainless steel

\$2,781.07 KRE3200

KLEENRITE® EDGE 300 PSI KLEENRITE® EXTRACTORS

- **VACUUM:** 3 stage
- **HEATER:** 1750 watt inline
- **CORD:** Single attached
- **CASTERS:** Locking
- **HOSES:** 25' (¼" solution & 1½" vacuum)
- **DETAIL TOOL:** Stainless steel
- Hose Bag

\$3,929.57 KRE3300

KLEENRITE® SPHERE KLEENRITE EXTRACTORS

- The SPHERE® is a compact, portable unit, designed for cleaning upholstery, automobiles, office partitions, and smaller areas of carpet. This 4-gallon unit is available with multiple pump, vacuum and heat choices. You can even have a heated unit that operates on a single cord at 15 amps. Each unit comes with a 15' hose set (upgrades are optional). Complimenting tools are optional.
- The SPHERE® has a convenient lift out vacuum tank that doubles as your waste bucket. These rotationally molded units have a durable polyethylene housing. All internal components are easily accessible. Internal components utilize high pressure and high temperature rated solution hoses with brass fittings and a plug-in wiring system for easy replacement.

- **PRESSURE:** 120PSI
- **HEATER:** 1000 watt inline
- **CASTERS:** Locking (2)
- **DETAIL TOOL:** Stainless steel
- **VACUUM:** 3 stage
- **CORD:** Single attached
- **HOSES:** 25' (¼" solution & 1¼" vacuum)
- Hose bag

\$1,826.56 KRE3000

KLEENRITE® EXTRACTOR REPLACEMENT PARTS KLEENRITE EXTRACTORS



- Kleen-Rite extractor replacement parts

\$234.01	KREP100	Blower, 3 Stage, 120 Volt, 5.7 Comp. Electro
\$211.69	KREP105	Kleen Rite Pump - 120PSI 115V with Plug
\$254.08	KREP110	Kleen Rite Pump - 200PSI 115V with Plug
\$145.71	KREP115	¼" Solution Hose - 25' with Quick Connect
\$94.01	KREP120	1½" x 25' Vacuum Hose
\$378.00	KREP125	Heat Exchange (Edge) 110V 1000W
\$354.50	KREP130	Heat Exchange (Edge) 120V 1200W

\$92.36	KREP135	Tubular Heater - 750W 110V 9.8" x 6.48"
\$31.37	KREP140	3" Import Caster with Lock
\$43.09	KREP152	10" Wheel - ½" Bore Economy
\$100.53	KREP155	Cord, 25' 12/3 SJT with TRM Main Circuit
\$21.55	KREP160	Water Resistant On/Off Switch
\$98.00	KREP165	Complete Lid for Edge (Gray)
\$12.79	KS1118	1 Gallon Defoamer Extractor Additive

OZONE MACHINES & AIR ACTIVATORS



MAKO OZONE MACHINE AND AIR DUCT SANITIZER OZONE MACHINES & AIR ACTIVATORS

SPECIFICATIONS:

- Output: 550mg/hr 3 ppm in 1 hr
- Warranty: 6-years on components and 6 months on UV tube
- Weight: 8 lbs.
- Coverage: 1400 cu ft.
- Quickly and Easily Eliminates Odors from: Chemicals, Pets, Food and Body Odors, Mold and Mildew, Fish, Dairy Spills, Tobacco, Skunk, Pesticides, etc.

FEATURES:

- Limited Maintenance Required
- Programmable Timer
- No Chemicals Needed
- Eliminates Mold in Air Conditioning Ducts
- Quick and Economical

\$562.50 EXMAKO-1



RAINBOW AIR ACTIVATOR 2000 THE OZONE SPECIALIST

ACCESSORIES AVAILABLE

- Designed for hotels, carpet cleaning and small ozone chambers
- Variable ozone output up to 2000 mg/hr
- 0.95 amps at maximum output
- 24 hour timer with a continuous run mode
- 20,000 sq/ft treatable area 230 CFM air movement
- Portable with a 6' removable power cord
- High output
- Weighs 18.5
- 5-year warranty on parts and labor (6 months on generator plates)
- Steel or aluminum cabinetry, powder coat finish
- Outstanding technical support and customer service
- All models available in 110 or 220 volt configurations

RAINBOW AIR ACTIVATOR 2000 WITH DUAL AUTO KIT THE OZONE SPECIALIST

- Same great features as OZ5401, but designed specifically to eliminate odors in automobiles, RVs, boats, showrooms, the 5600 Dual-Auto comes with two flanges, (2) 5 ft' hoses and (4) pieces of foam to enable the user to direct concentrated levels of ozone into 2 areas of a vehicle.

\$808.39 OZ5600-AUTO

\$601.01	OZ5600	Air Activator
\$121.47	OZ5600-AUTOKIT	Hose & Flange Kit



RAINBOW AIR ACTIVATOR 1000 THE OZONE SPECIALIST

ACCESSORIES AVAILABLE

- Designed for hotels, carpet cleaning and fire & flood restoration companies, this compact unit offers the following features:
- Variable ozone output up to 1000 mg/hr
- 0.55 amps at maximum output
- 24 hour timer with a continuous run mode
- 10,000 sq/ft treatable area 115 CFM air movement
- 6' removable power cord
- Weighs 14 lbs.
- 12" L x 7" H x 9" W
- 5-year warranty on parts and labor (6 months on generator plates)
- Aluminum cabinetry with some stainless steel components, powder coat finish
- Outstanding technical support and customer service
- All models available in 110 or 220 volt configurations

RAINBOW AIR ACTIVATOR 1000 WITH AUTO KIT THE OZONE SPECIALIST

- Same great features as OZ5600, but designed specifically to eliminate odors in automobiles, RVs, boats, showrooms, the 5401-Auto comes with a flange, (1) 5 ft. hose and (2) pieces of foam to enable the user to direct concentrated levels of ozone into a specific area.

\$612.68 OZ5401-AUTO

\$519.99	OZ5401	Air Activator
\$75.34	OZ5401-11MK	Maintenance Kit



SIGN UP FOR OUR WEEKLY EMAIL BLAST!

PUMPS

CAT PUMPS® EXTRACTOR PUMP

CAT PUMPS PLUNGER PUMPS



- This is a compact, direct drive (1750 RPM) motorized pump unit used in portable extractors, electric truck mounts, misting, hydrostatic testing, and wash down applications. It is constructed of plated aluminum crankcase body, 304 stainless steel valve assemblies, solid ceramic plungers, special blend fluorocarbon seals and O-rings. Pump features a patented greaseless design, 100% sealed wet end and keyed shaft so the pump can operate clock-wise or counterclockwise rotation. Equipped with a DC permanent magnet, ODP motor.
- Perfect fit for extractor foot print
- The most reliable extractor pump available
- MAX FLOW:** 0.75 GPM
- MIN PRESSURE:** 100 PSI
- MAX PRESSURE:** 500 PSI
- INLET PORT:** 3/8" NPT
- OUTLET PORT:** 3/8" NPT
- HORSEPOWER:** 1/3 HP

\$339.97 PU1XP075.03DC

CAT PUMPS® EXTRACTOR PUMP

CAT PUMPS PLUNGER PUMPS



- This is a compact, direct drive (1750 RPM) motorized pump unit used in portable extractors, electric truck mounts, misting, hydrostatic testing, and wash down applications. It is constructed of plated aluminum crankcase body, 304 stainless steel valve assemblies, solid ceramic plungers, special blend fluorocarbon seals and O-rings. Pump features a patented greaseless design, 100% sealed wet end and keyed shaft so pump can operate clock-wise or counterclockwise rotation. Equipped with a AC induction, ODP motor certified to CE, UL and CSA.
- Perfect fit for extractor foot print
- The most reliable extractor pump available
- MAX FLOW:** 1.5 GPM
- MIN PRESSURE:** 100 PSI
- MAX PRESSURE:** 600 PSI
- INLET PORT:** 3/8" NPT
- OUTLET PORT:** 3/8" NPT
- HORSEPOWER:** 1/2 HP

\$535.55 PU1XP150.051

MODEL G57 DOUBLE DIAPHRAGM AIR DRIVEN TRANSFER PUMP

FLOJET PUMPS



- Constructed of corrosion-resistant materials to handle a variety of chemicals
- Patented shuttle valve eliminates stalling
- Air inlet & outlet are 1/4", product inlet & outlet are 1/2" or 3/8"
- Double diaphragm air driven transfer pump
- Diaphragms and check valves are Santoprene® or Viton®
- Flow rates to 7 GPM
- Pressures to 100 PSI
- Self priming to 15'

PRICE	PART #	FLOJET #	TYPE
\$103.58	FP7040	G575215D	Santoprene®
\$153.27	FP7020	G573215D	Viton®

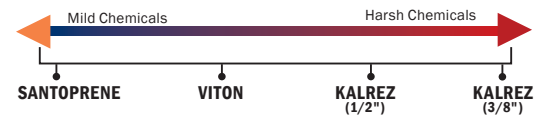

HYDROMINDERS



511 LOW VOLUME HYDROMINDER (4.5 GPM) WITH SIPHON BREAKER

HYDRO SYSTEMS

- Dilution Ratio: 240:1 (Max) to 4:1 (Min)
- Consistent automatic dilution for better chemical performance
- Siphon breaker & mounting bracket
- Uses water power; no electricity required

\$167.50 IN511

515 LOW VOLUME HYDROMINDER (1.5 GPM) WITH SIPHON BREAKER

HYDRO SYSTEMS

- Dilution Ratio: 100:1 (Max) to 1:1 (Min)
- Consistent automatic dilution for better chemical performance
- Siphon breaker & mounting bracket
- Uses water power; no electricity required

\$210.75 IN515

208 HYDROMASTER HI-CONCENTRATE

HYDRO SYSTEMS

- High flow, automatic dilution for large tanks, totes, and drums
- Drum or wall-mounted proportioners automatically mix liquid cleaning and sanitizing concentrates with water and dispense the diluted solution into any container

\$108.89 INH208



THESE PUMPS ARE ROHS COMPLIANT

CAT PUMPS® CERAMIC PLUNGER PUMPS



2530 CAT PUMPS CERAMIC PLUNGER PUMPS

- FLOW: 25 GPM
- RPM: 1025 RPM
- PRESSURE: 100 - 1200 PSI
- HP: 20.5

\$3,736.58 PU02530

2530 KITS CAT PUMPS CERAMIC PLUNGER PUMPS

PART #	DESCRIPTION	KITS NEEDED
PU33952	Valve Kit	x 2
PU30952	Seal Kit	x 1
PU30614	Pump Rails	-



5CP2140WCS3 DIRECT DRIVE CAT PUMPS CERAMIC PLUNGER PUMPS

- FLOW: 4.0 GPM
- RPM: 1725 RPM
- PRESSURE: 100 - 2500 PSI
- HP: 6.9

\$839.17 PU5CP2140WCS3

5CP2140WCS3 KITS CAT PUMPS CERAMIC PLUNGER PUMPS

PART #	DESCRIPTION	KITS NEEDED
PU30821	Valve Kit	x 2
PU31638	Seal Kit (high temp)	x 1
PU08230	Flex Coupler 20MM x 1½"	-
PU76184.5CP	Bell Housing	-



5CP6190 DIRECT DRIVE CAT PUMPS CERAMIC PLUNGER PUMPS

- FLOW: 10.0 GPM
- RPM: 1750 RPM
- PRESSURE: 100 - 1200 PSI
- HP: 8.2

\$922.20 PU5CP6190

NOTE: This pump no longer includes a shaft protector.

5CP6190 KITS CAT PUMPS CERAMIC PLUNGER PUMPS

PART #	DESCRIPTION	KITS NEEDED
PU34920	Valve Kit	x 2
PU76620	Seal Kit	x 1
PU8275	Flex Coupler 20MM x 1¾"	-
PU76215.5CP	Bell Housing	-



5CP6180CSS DIRECT DRIVE CAT PUMPS CERAMIC PLUNGER PUMPS

- FLOW: 8.2 GPM
- RPM: 1750 RPM
- PRESSURE: 100 - 1500 PSI
- HP: 8.4

\$922.12 PU5CP6180CSS

5CP6180CSS KITS CAT PUMPS CERAMIC PLUNGER PUMPS KITS

PART #	DESCRIPTION	KITS NEEDED
PU34920	Valve Kit	x 2
PU76620	Seal Kit	x 1
PU8275	Flex Coupler 20MM x 1¾"	-
PU76215.5CP	Bell Housing	-



56 CAT PUMPS CERAMIC PLUNGER PUMPS

- FLOW: 5.5 GPM
- RPM: 1210 RPM
- PRESSURE: 100 - 3500 PSI
- HP: 13.2

\$1,467.91 PU00056

56 KITS CAT PUMPS CERAMIC PLUNGER PUMPS KITS

PART #	DESCRIPTION	KITS NEEDED
PU33820	Valve Kit	x 2
PU30799	Seal Kit	x 1
PU30645	Pump Rails	-
PU30206	Pump Pulley	-



CAT PUMPS® CERAMIC PLUNGER PUMPS

THESE PUMPS ARE ROHS COMPLIANT



310

CAT PUMPS CERAMIC PLUNGER PUMPS

- FLOW: 4 GPM
- RPM: 950 RPM
- PRESSURE: 100 - 2200 PSI
- HP: 6

\$711.38 PU00310

310S

CAT PUMPS CERAMIC PLUNGER PUMPS

- FLOW: 4 GPM
- RPM: 950 RPM
- PRESSURE: 100 - 2200 PSI
- HP: 6

\$780.94 PU00310S

310B

CAT PUMPS CERAMIC PLUNGER PUMPS

- FLOW: 4 GPM
- RPM: 950 RPM
- PRESSURE: 100 - 2200 PSI
- HP: 6

\$774.48 PU00310B



5CP2120W & 5CP2120B

CAT PUMPS CERAMIC PLUNGER PUMPS

- FLOW: 4 GPM
- RPM: 950 RPM
- PRESSURE: 100 - 2500 PSI
- HP: 6.9

\$683.66 PU5CP2120W
\$795.64 PU5CP2120B



3CP1120

CAT PUMPS CERAMIC PLUNGER PUMPS

- FLOW: 4.2 GPM
- RPM: 1725 RPM
- PRESSURE: 100 - 2200 PSI
- HP: 6.3

\$550.40 PU3CP1120



270

CAT PUMPS CERAMIC PLUNGER PUMPS

- FLOW: 3.5 GPM
- RPM: 1420 RPM
- PRESSURE: 100 - 1500 PSI
- HP: 3.6

\$588.80 PU00270



1540E

CAT PUMPS CERAMIC PLUNGER PUMPS

- FLOW: 19.3 GPM
- RPM: 1180 RPM
- PRESSURE: 100 - 1200 PSI
- HP: 15.8

\$2,501.12 PU1540E

310 & 310S KITS

CAT PUMPS CERAMIC PLUNGER PUMP KITS



PART #	DESCRIPTION	KITS NEEDED
PU30821	Valve Kit	x 2
PU30623	Seal Kit	x 1
PU30945	Bushing	-
PU30633	Pump Pulley	-
PU30696	Reverse Plier	-
PU33004	Seal Case Socket for 1/2" Drive	-
PU810027	Complete Head for 310, 340, 350	-
PU310RA-WP	Rear Assembly with Plungers	-

NOTE: PU00310 pump no longer includes a shaft protector.

5CP2120W & 5CP2120B KITS

CAT PUMPS CERAMIC PLUNGER PUMP KITS



PART #	DESCRIPTION	KITS NEEDED
PU30821	Valve Kit	x 2
PU33628	Seal Kit	x 1
PU30945	Bushing	-
PU30611	Pump Rails	-
PU30633	Pump Pulley	-

3CP1120

CAT PUMPS CERAMIC PLUNGER PUMP KITS

PART #	DESCRIPTION	KITS NEEDED
PU33062	Valve Kit	x 2
PU33983	Seal Kit	x 1
PU30612	Pump Rails	-
PU30246	Pump Pulley	-

270 KITS

CAT PUMPS CERAMIC PLUNGER PUMP KITS

PART #	DESCRIPTION	KITS NEEDED
PU30915	Valve Kit	x 1
PU30914	Seal Kit	x 1
PU30612	Pump Rails	-
PU30246	Pump Pulley	-

1540E KITS

CAT PUMPS CERAMIC PLUNGER PUMP KITS

PART #	DESCRIPTION	KITS NEEDED
PU31775	Valve Kit	x 2
PU31770	Seal Kit	x 1
PU30613	Pump Rails	-
PU30206	Pump Pulley 10" 2-Groove	-



THESE PUMPS ARE ROHS COMPLIANT

CAT PUMPS® CERAMIC PLUNGER PUMPS



340 DIRECT DRIVE

CAT PUMPS CERAMIC PLUNGER PUMPS

- FLOW: 4 GPM
- RPM: 1725 RPM
- PRESSURE: 100 - 1800 PSI
- HP: 5.0

\$711.38	PU00340	With Brass Manifold
\$780.94	PU00340S	With Stainless Steel Sleeves
\$774.48	PU00340B	With Special Brass Manifold



350 DIRECT DRIVE

CAT PUMPS CERAMIC PLUNGER PUMPS

- FLOW: 5 GPM
- RPM: 1725 RPM
- PRESSURE: 100 - 1500 PSI
- HP: 5.1

\$711.38	PU00350	With Brass Manifold
\$820.74	PU00350B	With Special Brass Manifold



350S

CAT PUMPS CERAMIC PLUNGER PUMPS

- FLOW: 5 GPM
- RPM: 1725 RPM
- PRESSURE: 100-1500 PSI

\$827.98	PU00350S	304 stainless steel sleeve inserts
-----------------	-----------------	------------------------------------



530

CAT PUMPS CERAMIC PLUNGER PUMPS

- FLOW: 5 GPM
- RPM: 1100 RPM
- PRESSURE: 100 - 2500 PSI
- HP: 8.6

\$1,203.71	PU00530
-------------------	----------------

NOTE: Brackets not included.



1050

CAT PUMPS CERAMIC PLUNGER PUMPS

- FLOW: 10 GPM
- RPM: 958 RPM
- PRESSURE: 100 - 2200 PSI
- HP: 15.1

\$2,142.21	PU01050
-------------------	----------------

NOTE: Brackets not included.

340 KITS

CAT PUMPS CERAMIC PLUNGER PUMP KITS

PART #	DESCRIPTION	KITS NEEDED
PU30821	Valve Kit	x 2
PU30623	Seal Kit	x 1
PU08022	Hollow Shaft Motor Flange*	-
PU76184.5FR	Bell Housing	-
PU08230	Flex Coupler 20mm x 1 1/8"	-

* FOR USE WITH BALDOR MOTOR PU8029M

350 & 350S KITS

CAT PUMPS CERAMIC PLUNGER PUMP KITS

PART #	DESCRIPTION	KITS NEEDED
PU30821	Valve Kit	x 2
PU30623	Seal Kit	x 1
PU76184.5FR	Bell Housing	-
PU08230	Flex Coupler 20MM x 1 1/8"	-

530 KITS

CAT PUMPS CERAMIC PLUNGER PUMPS

PART #	DESCRIPTION	KITS NEEDED
PU30820	Valve Kit	x 2
PU30488	Seal Kit	x 1
PU30645	Pump Rails	-
PU30206	Pump Pulley	-

1050 KITS

CAT PUMPS CERAMIC PLUNGER PUMP KITS

PART #	DESCRIPTION	KITS NEEDED
PU34920	Valve Kit	x 2
PU30913	Seal Kit	x 1
PU30613	Pump Rails	-
PU30206	Pump Pulley	-



3535

CAT PUMPS CERAMIC PLUNGER PUMPS

- FLOW: 36 GPM
- RPM: 800 RPM
- PRESSURE: 100 - 1200 PSI
- HP: 29.7

\$4,660.68	PU03535
-------------------	----------------

3535 KITS

CAT PUMPS CERAMIC PLUNGER PUMP KITS

PART #	DESCRIPTION	KITS NEEDED
PU34235	Valve Kit	x 2
PU31040	Seal Kit	x 1
PU92674	Pump Rails	-
Factory Sized	Pump Pulley	-

FOR HIGHER GPM NEEDS, CONSIDER 3545

CAT PUMPS® PISTON PUMPS



290

CAT PUMPS PISTON PUMPS

- FLOW: 3.5 GPM
- RPM: 1200 RPM
- PRESSURE: 100 - 1200 PSI
- HP: 2.9

\$572.93	PU00290
-----------------	----------------

290 KITS

CAT PUMPS PISTON PUMP KITS

PART #	DESCRIPTION	KITS NEEDED
PU76023	Cup Kit	x 1
PU30686	Valve Kit (Quiet)	x 1
PU30305	Seal Kit	x 1
PU30431	Sleeve & Seal Kit	x 1
PU30272	Hot-Cup Kit	x 1
PU30246	Pulley & Key	-



CAT PUMPS® PISTON PUMPS

THESE PUMPS ARE ROHS COMPLIANT



323 CAT PUMPS PISTON PUMPS

- FLOW: 5.0 GPM
- RPM: 1000 RPM
- PRESSURE: 100 - 1500 PSI
- HP: 5.1

\$871.93 PU00323



390 CAT PUMPS PISTON PUMPS

- FLOW: 12 GPM
- RPM: 1200 RPM
- PRESSURE: 100 - 600 PSI
- HP: 4.9

\$949.76 PU00390



430 CAT PUMPS PISTON PUMPS

- FLOW: 5.0 GPM
- RPM: 1040 RPM
- PRESSURE: 100 - 1000 PSI
- HP: 3.4

\$808.96 PU00430

NOTE: Brackets not included.



623 CAT PUMPS PISTON PUMPS

- FLOW: 6.0 GPM
- RPM: 850 RPM
- PRESSURE: 100 - 1,200 PSI
- HP: 4.9

\$1,380.86 PU00623

NOTE: Brackets not included.



820 CAT PUMPS PISTON PUMPS

- FLOW: 10 GPM
- RPM: 940 RPM
- PRESSURE: 100 - 1000 PSI
- HP: 6.9

\$1,380.86 PU00820



1010 CAT PUMPS PISTON PUMPS

- FLOW: 13 GPM
- RPM: 900 RPM
- PRESSURE: 100 - 700 PSI
- HP: 6.2

\$1,380.86 PU1010

323 KITS

CAT PUMPS PISTON PUMP KITS

PART #	DESCRIPTION	KITS NEEDED
PU30993	Cup Kit	x 1
PU30859	Valve Kit	x 1
PU30305	Seal Kit	x 1
PU30312	Sleeve & Seal Kit	x 1
PU30858	Bac-Cup Kit	x 1
PU34011	Blue Dot Seal Kit	x 1
PU30611	Pump Rails	-
PU30633	Pump Pulley	-

390 KITS

CAT PUMPS PISTON PUMPS

PART #	DESCRIPTION	KITS NEEDED
PU31822	Cup Kit	x 1
PU34010	Valve Kit	x 1
PU30305	Seal Kit	x 1
PU31824	Sleeve & Seal Kit	x 1
PU30611	Pump Rails	-
PU30633	Pump Pulley	-

430 KITS

CAT PUMPS PISTON PUMP KITS

PART #	DESCRIPTION	KITS NEEDED
PU30023	Cup Kit	x 1
PU30686	Valve Kit	x 1
PU30305	Seal Kit	x 1
PU30312	Sleeve & Seal Kit	x 1
PU30229	Blue Dot Seal Kit	x 1
PU30611	Pump Rails	-
PU30048	Pump Pulley	-

623 KITS

CAT PUMPS PISTON PUMP KITS

PART #	DESCRIPTION	KITS NEEDED
PU30220	Cup Kit	x 1
PU30687	Valve Kit	x 1
PU30305	Seal Kit	x 1
PU30397	Sleeve & Seal Kit	x 1
PU30822	Bac-Cup Kit	x 1
PU30226	Blue Dot Seal Kit	x 1
PU30613	Pump Rails	-

820

CAT PUMPS PISTON PUMP KITS

PART #	DESCRIPTION	KITS NEEDED
PU30222	Cup Kit	x 1
PU30687	Valve Kit	x 1
PU30305	Seal Kit	x 1
PU30397	Sleeve & Seal Kit	x 1
PU30226	Blue Dot Seal Kit	x 1
PU30613	Pump Rails	-

1010

CAT PUMPS PISTON PUMP KITS

PART #	DESCRIPTION	KITS NEEDED
PU30224	Cup Kit	x 1
PU30687	Valve Kit	x 1
PU30305	Seal Kit	x 1
PU30397	Sleeve & Seal Kit	x 1
PU30226	Blue Dot Seal Kit	x 1
PU30613	Pump Rails	-



310-340-350-310B-340B-350B CAT PUMPS

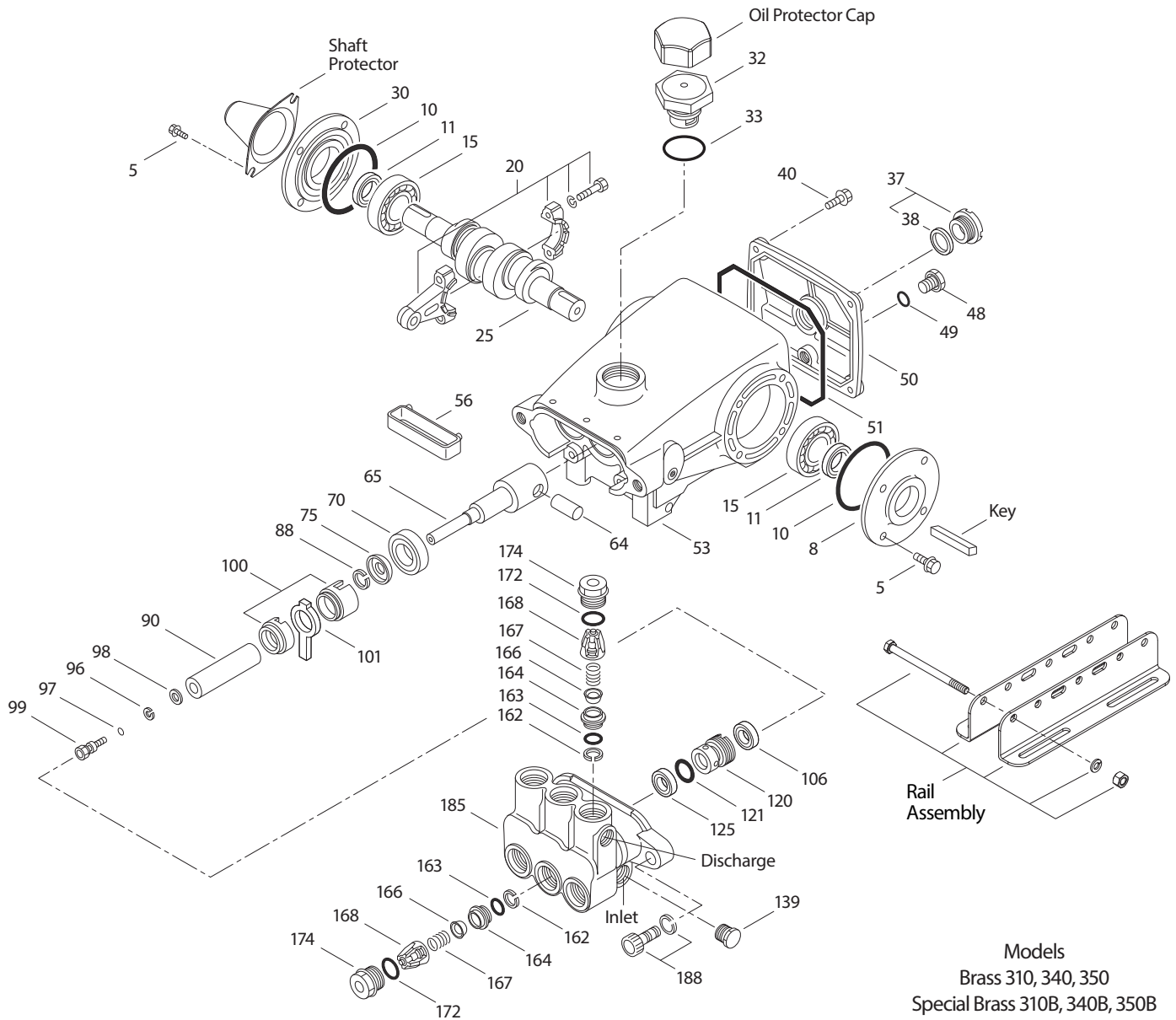

Models
Brass 310, 340, 350
Special Brass 310B, 340B, 350B
November 2023

OPTIONAL PARTS AND ACCESSORIES

PART	DESCRIPTION	QTY
30057	Key (M6 x 6 x 25)	1
30659	Kit, Complete Mounting	1
30611	Mount, Rail Assembly (Belt Drive Only)	1
30243	Mount, Direct (Belt Drive Only)	1
118672	Protector, Shaft	1
828710	Protector, Oil Cap	1
30633	Assembly, Pulley & Key (Not Shown)	1
30944	Assembly, Hub & Key (Not Shown)	1
34334	Kit, Oil Drain (3/8" x 24") (Not Shown)	1

SERVICE PARTS

PART	DESCRIPTION	QTY
30623	Kit, Seal – Standard NBR	1
30821	Kit, Valve – Standard NBR	2
6107	Oil, Bottle (21 oz) (Fill to Specified Crankcase Capacity Prior to Start-up)	1
30696	Reverse Pliers (Not Shown)	1
33004	Socket, Seal Case (1/2" Drive) (Not Shown)	1
810027	Head, Complete with NBR Seals and O-Rings (Models 310, 340, 350)	1
818471	Head, Complete with NBR Seals and O-Rings (Models 310B, 340B, 350B)	1



ITEM	PART NUMBERS				DESCRIPTION	QTY
	310, 340 350	MATL	310B, 340B 350B	MATL		
5	125824	STCP R	125824	STCP R	Screw, HHC, Sems (M6 x 16) (See Tech Bulletin 074)	8
8	43344	AL	43344	AL	Cover, Bearing	2/1/2
10	43343	NBR	43343	NBR	O-Ring, Bearing Cover-70D	2
11	43222	NBR	43222	NBR	Seal, Oil, Crankshaft	2/1/2
15	14480	STL	14480	STL	Bearing, Ball	2
20	45883	HS	45883	HS	Rod, Connecting Assembly (See Tech Bulletin 074)	3
25	43342	FCM	43342	FCM	Crankshaft, Dual-End (M18) Models 310, 310B)	1
	44945	FCM	44945	FCM	Crankshaft, Single-End (M10) Models 340, 340B)	1
	43838	FCM	43838	FCM	Crankshaft, Dual-End (M12) Models 350, 350B)	1
30	44949	AL	44949	AL	Cover, Blind Shaft (Models 340, 340B)	1
32	43211	ABS	43211	ABS	Cap, Oil Filler	1
33	14177	NBR	14177	NBR	O-Ring, Filler Cap-70D	1
37	92241	PC	92241	PC	Gauge, Oil, Bubble with Gasket	1
38	44428	NBR	44428	NBR	Gasket, Flat, Oil Gauge-80D	1
40	126541	STCP R	126541	STCP R	Screw, HHC, Sems (M6 x 20) (See Tech Bulletin 074)	4
48	25625	STCP	25625	STCP	Plug, Drain (1/4" x 19 BSP)	1
49	23170	NBR	23170	NBR	O-Ring, Drain Plug-70D	1
50	48772	AL	48772	AL	Cover, Rear	1
51	48773	NBR	48773	NBR	O-Ring, Rear Cover	1
53	48769	AL	48769	AL	Crankcase	1
56	43355	POP	43355	POP	Pan, Oil	1
64	43351	CM	43351	CM	Pin, Crosshead	3
65	43365	ZZCP	43365	ZZCP	Rod, Plunger	3
70	43228	NBR	43228	NBR	Seal, Oil, Crankcase	3
75	43328	S	43328	S	Slinger, Barrier	3
88	45697	S	45697	S	Washer, Keyhole (M18 x 10)	3
90	43367	CC	43367	CC	Plunger (M20 x 72)	3
96	43235	PTFE	43235	PTFE	Backup Ring, Plunger Retainer	3
97	17399	NBR	17399	NBR	O-Ring, Plunger Retainer-80D	3
98	45891	CU	45891	CU	Gasket	3
99	104360	S	104360	S	Retainer, Plunger with Stud	3
100	45688	PVDF	45688	PVDF	Retainer, Seal, 2-Piece	3
101	43302	—	43302	—	Wick, Long Tab	3
106	43305	NBR	43305	NBR	Seal, Low-Pressure with S-Spring	3
120	45679	BB	45679	BB	Case, Seal (See Tech Bulletin 074)	3
121	14200	NBR	14200	NBR	O-Ring, Seal Case-70D	3
125	43307	SNG	43307	SNG	Seal, High-Pressure with S-Support	3
139	22179	BBCP	22179	BBCP	Plug, Inlet (1/2" NPT[M])	1
162	48361	D	48361	D	Backup Ring, Seat	6
163	43358	NBR	43358	NBR	O-Ring, Seat-70D	6
164	43725	S	43725	S	Seat	6
166	43723	S	43723	S	Valve	6
167	43750	S	43750	S	Spring, Valve	6
168	44565	PVDF	44565	PVDF	Retainer, Valve Spring	6
172	17615	NBR	17615	NBR	O-Ring, Valve Plug-75D	6
174	43849	BBCP	43849	BBCP	Plug, Valve (See Tech Bulletin 074)	6
185	44837	BBCP	49721	SBCP	Head, Manifold	1
188	126520	STCP R	126520	STCP R	Screw, HSH, Sems (M10 x 35) (See Tech Bulletin 074)	2

Bold print part numbers are unique to a particular pump model. *Italics are optional items.* R Components comply with RoHS Directive.

*Review individual parts in each kit for material code identification. For additional technical information see www.catpumps.com/literature/tech-bulletins

MATERIAL CODES (Not Part of Part Number): ABS=ABS Plastic AL=Aluminum BB=Brass BBCP=Brass/Chrome Plated CC=Ceramic CM=Chrome-moly CU=Copper D=Acetal EPDM=Ethylene Propylene Diene Monomer FCM=Forged Chrome-moly FPM=Fluorocarbon HS=High Strength HT=High Temp (EPDM Alternative) NBR=Medium Nitrile (Buna-N) PC=Polycarbonate PE=Polyethylene POP=Polypropylene PTFE=Pure Polytetrafluoroethylene PVDF=Polyvinylidene Fluoride S=304SS SBCP=Special Brass/Chrome Plated SNG=Special Blend (Buna) ST2=Special PTFE 2 STL=Steel STCP=Steel/Chrome Plated STZP=Steel/Zinc Plated ZZCP=Chrome Plated/Steel - Zamak



5CP2120W-5CP2140WCS-5CP2150W-5CP2120B-5CP2140BCS-5CP2150B CAT PUMPS

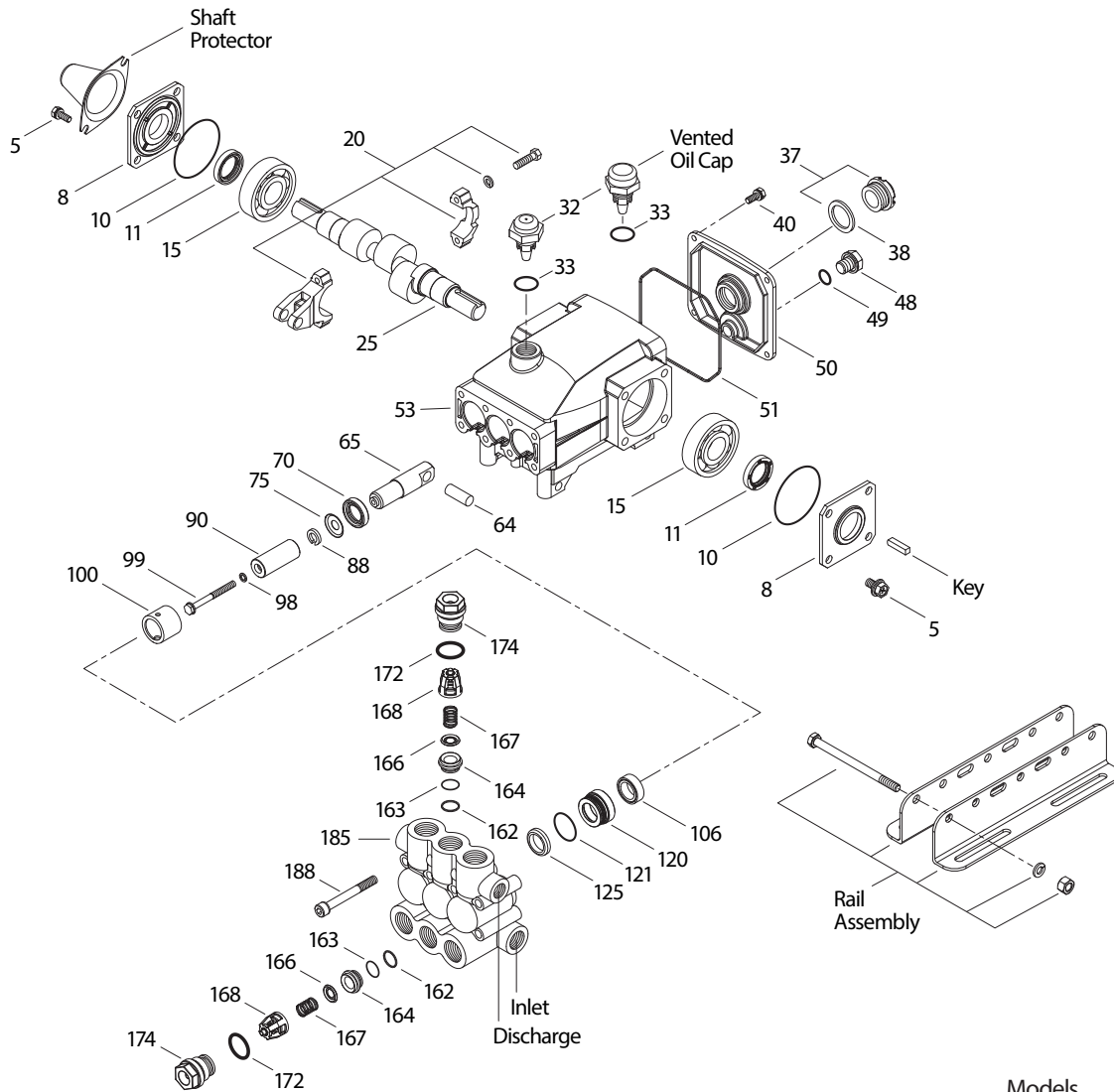

Models
5CP2120W, 5CP2120B
5CP2140WCS, 5CP2140BCS
5CP2150W, 5CP2150B
November 2023

OPTIONAL PARTS AND ACCESSORIES

PART	DESCRIPTION	QTY
30057	Key (M6 x 6 x 25)	1
30659	Kit, Complete Mounting	1
30611	Mount, Rail Assembly (4.22" – See Dimensional Drawing)	1
30613	Mount, Rail Assembly (5.02" – See Dimensional Drawing)	1
76513	Mount, Rail Assembly (5.52" – See Dimensional Drawing)	1
30637	Mount, Rail Assembly (Retro-Fit) (See Tech Bulletin 078)	1
30243	Mount, Direct (Belt Drive Only)	1
118672	Protector, Shaft	1
127409	Cap, Vented with O-Ring	1
30633	Assembly, Pulley & Key (Not Shown)	1
30944	Assembly, Hub & Key (Not Shown)	1
34334	Kit, Oil Drain (3/8" x 24") (Not Shown)	1

SERVICE PARTS

PART	DESCRIPTION	QTY
33628	Kit, Seal – Standard NBR	1
30821	Kit, Valve – Standard NBR	2
6107	Oil, Bottle (21 oz) (Fill to Specified Crankcase Capacity Prior to Start-up)	1
30696	Reverse Pliers (Not Shown)	1
33004	Socket, Seal Case (1/2" Drive) (Not Shown)	1
816650	Head, Complete with NBR Seals & O-Rings (Models 5CP2120W, 2140WCS, 2150W)	1
818472	Head, Complete with NBR Seals & O-Rings (Models 5CP2120B, 2140BCS, 2150B)	1



PARTS LIST

ITEM	PART NUMBER	MATL	PART NUMBER	MATL	PART NUMBER	MATL	DESCRIPTION	QTY
	5CP2120W		5CP2140WCS		5CP2150W			
	5CP2120B		5CP2140BCS		5CP2150B			
5	126542	STCP R	126542	STCP R	126542	STCP R	Screw, Sems HHC (M8 x 16) (See Tech Bulletin 074)	8
8	46910	AL	46910	AL	46910	AL	Cover, Bearing	2/1/2
10	14028	NBR	14028	NBR	14028	NBR	O-Ring, Bearing Cover-70D	2
11	43222	NBR	43222	NBR	43222	NBR	Seal, Oil, Crankshaft	2/1/2
15	14480	STL	14480	STL	14480	STL	Bearing, Ball	2
20	48742	TNM	48742	TNM	48742	TNM	Rod, Connecting Assembly (See Tech Bulletin 074)	3
25	46928	FCM	—	—	46982	FCM	Crankshaft, Dual-End	1
	—	—	48203	FCM	—	—	Crankshaft, Single-End (M10)	1
30	—	—	48224	AL	—	—	Cover, Bearing Blind	1
32	46798	—	46798	—	46798	—	Cap, Oil Filler, Domed	1
33	14179	NBR	14179	NBR	14179	NBR	O-Ring, Oil Filler Cap-70D	1
37	92241	PC	92241	PC	92241	PC	Gauge, Oil, Bubble with Gasket-80D	1
38	44428	NBR	44428	NBR	44428	NBR	Gasket, Flat, Oil Gauge-80D	1
40	125824	STCP R	125824	STCP R	125824	STCP R	Screw, Sems HHC (M6 x 16) (See Tech Bulletin 074)	4
48	25625	STCP	25625	STCP	25625	STCP	Plug, Drain (1/4" x 19 BSP)	1
49	23170	NBR	23170	NBR	23170	NBR	O-Ring, Drain Plug-70D	1
50	46940	AL	46940	AL	46940	AL	Cover, Rear	1
51	14044	NBR	14044	NBR	14044	NBR	O-Ring, Rear Cover	1
53	48617	AL	48617	AL	48617	AL	Crankcase	1
64	46746	CM	46746	CM	46746	CM	Pin, Crosshead	3
65	48458	BBNP	48458	BBNP	48458	BBNP	Rod, Plunger	3
70	46838	NBR	46838	NBR	46838	NBR	Seal, Oil, Crankcase	3
75	43328	S	43328	S	43328	S	Slinger, Barrier	3
88	45697	S	45697	S	45697	S	Washer, Keyhole (M18 x 10)	3
90	46841	CC	46841	CC	46841	CC	Plunger (M20 x 50)	3
98	46730	NBR	46730	NBR	46730	NBR	Washer, Seal-90D	3
99	† 48201	SS	† 48201	SS	† 48201	SS	Retainer, Plunger with Stud (M6)	3
100	46749	PVDF	46749	PVDF	46749	PVDF	Retainer, Seal	3
106	43305	NBR	43305	NBR	43305	NBR	Seal, Low-Pressure with S-Spring	3
120	46843	BB	46843	BB	46843	BB	Case, Seal (Press-in-Style)	3
121	13978	NBR	13978	NBR	13978	NBR	O-Ring, Seal Case-70D	3
125	43307	SNG	43307	SNG	43307	SNG	Seal, High-Pressure with S-Support	3
162	48361	D	48361	D	48361	D	Backup Ring, Seat	6
163	43358	NBR	43358	NBR	43358	NBR	O-Ring, Seat-70D	6
164	43725	S	43725	S	43725	S	Seat	6
166	43723	S	43723	S	43723	S	Valve	6
167	43750	S	43750	S	43750	S	Spring	6
168	44565	PVDF	44565	PVDF	44565	PVDF	Retainer, Spring	6
172	17615	NBR	17615	NBR	17615	NBR	O-Ring, Valve Plug-75D	6
174	43849	BBCP	43849	BBCP	43849	BBCP	Plug, Valve (See Tech Bulletin 074)	6
185	48245	W770	48245	W770	48245	W770	Manifold, Head-W770	1
	49716	SBCP	49716	SBCP	49716	SBCP	Manifold, Head-Special Brass	1
188	126513	STCP R	126513	STCP R	126513	STCP R	Screw, HSH (M8 x 70) (See Tech Bulletin 074)	8

Bold print part numbers are unique to a particular pump model. Italics are optional items. † Production parts are different than repair parts.
 R Components comply with RoHS Directive. W770 effective with 97 production. For additional technical information see www.catpumps.com/literature/tech-bulletins
 MATERIAL CODES (Not Part of Part Number): AL=Aluminum BB=Brass BBCP=Brass/Chrome Plated BBNP=Brass/Nickel Plated CC=Ceramic CM=Chrome-moly
 D=Acetal EPDM=Ethylene Propylene Diene Monomer FCM=Forged Chrome-moly FPM=Fluorocarbon HT=Hi-Temp (EPDM Alternative)
 NBR=Medium Nitrile (Buna-N) PC=Poly Carbonate PVDF=Polyvinylidene Fluoride S=304SS SBCP=Special Brass/Chrome Plated SS=316SS
 SNG=Special Blend (Buna) STL=Steel SHT=Special PTFE High Temp STCP=Steel/Chrome Plated STZP=Steel/Zinc Plated
 TNM=Special High Strength W770=Special Alloy

CAT PUMPS® CENTRIFUGAL PUMPS



VARIOUS CENTRIFUGAL PUMPS

CAT PUMPS CENTRIFUGAL PUMPS



- Stainless steel end-suction single stage centrifugal pumps offer dependable performance and flexibility in moving high volume liquids at low pressure. Sold as either a Pump Kit With Seal or Motorized Unit. *Two Stage Motorized Unit available upon request.

\$851.46	PU3K124WT313	Cat Pump 1HP 3PH 24GPM 45PSI
\$1,001.57	PU3K152WT0	Cat Pump 1 1/2HP 1PH 63GPM 44PSI
\$1,053.80	PU3K162WT3	Cat Pump 3HP 3PH 63GPM 63PSI
\$981.08	PU3K131MT3	Cat Pumps 2HP 3PH 38GPM 63PSI

PUMP SUPPLIES & KITS



CAT PUMPS 310 REPAIR KIT

KLEEN-RITE KITS



- Kit will service 310, 310B, 310S, 340 and 350 pumps.
- (1) 36H993 Nitrile Coated Gloves - Large
- (1) 6100 Cat Pumps Oil - 21 oz. Bottle
- (1) **30623 CAT PUMPS SEAL KIT**
 - (3) 43307 Seal, HPS w/S-NBR
 - (3) 43305 Seal, LPS w/S-Spg-NBR
 - (3) 14200 O-Ring, Seal Case-NBR
 - (3) 17399 O-Ring, Ret, Plgr-NBR
 - (3) 43302 Wick, Long Tab
- (2) **30821 CAT PUMPS VALVE KITS**
 - (3) 44565 Retainer, Spring-PVDF
 - (3) 43750 Spring-S
 - (3) 43723 Valve-S
 - (3) 43725 Seat-S
 - (3) 43358 O-Ring, Seat-70D-NBR
 - (3) 48361 Back-Up Ring, Seat-D
 - (3) 17615 O-Ring, Valve Plug-75D-NBR

\$256.07 KRK2101



CAT PUMPS 5CP2120W REPAIR KIT

KLEEN-RITE KITS



- Kit will service 5CP2120W pumps
- Seals, valves, and oil are genuine Cat Pumps® replacement parts
- (2) 30821 Valve Kits
 - (1) 33628 Seal Kit
- (1) 6100 Cat Pumps Oil - 21 oz. Bottle
 - (1) 36H993 Nitrile Coated Gloves - Large

\$261.62 KRK2102



OIL DRAIN KITS

CAT PUMPS SUPPLIES & KITS



- For 3FR, 4FR, 5FR, 7FR, 10FR, 15FR, 25FR Piston Pumps or Plunger Pumps

\$46.08 PU34334



OIL DRAIN KITS

CAT PUMPS SUPPLIES & KITS



- Fits piston pumps 6020-6041, plunger pumps 3501-3560, 3801-3841K, 6747-6775 & 6801-6861K

\$51.98 PU34314



CAT PUMPS OIL

CAT PUMPS SUPPLIES & KITS



\$9.01	PU06100	21 oz. bottles
\$93.75	PU06105	2.5 gallons



ACCUMULATOR PULSATION DAMPENER SUPPLIES & KITS

- Absorbs system shocks while minimizing pulsations, pipe vibration, water hammering and pressure fluctuations. Pumps will see decreased wear and have longer life. Pulsation dampeners are tied directly onto the discharge manifold or plumbed immediately downstream of the pump.

\$117.18	PDK103	10 GPM • 600-3000 PSI
\$339.22	PDK403	40 GPM • 3000 PSI

PUMPS



EMPEROR SERIES FROM GENERAL PUMP®

EMPEROR SERIES GENERAL PUMP

- Specifically designed to handle the rigorous duty cycles, high temperatures and chemicals associated with self-serve carwash applications.
- These premium pumps can withstand temperatures up to 185°F and can run dry for several hours.



GPHTS2215SR

EMPEROR SERIES FROM GENERAL PUMP

- **FLOW:** 4.0/5.0 GPM
- **PSI:** 2300
- **SHAFT OD:** 24MM
- **RPM:** 950/1200

FEATURES & BENEFITS:

- Can run dry for several hours
- Water temps up to 185°F
- Nickel-plated manifold & valve caps provide corrosion resistant operation and helps reduce damage caused by cavitation
- Side sight glass
- Direct replacement for CAT 310/5CP2120W with same RPM and Flow
- **SPECIFY LEFT HAND DRIVE IF YOU'RE LOOKING AT THE PUMP MANIFOLD AND YOUR PULLEY OR THE PUMP CRANKSHAFT IS ON THE LEFT**

\$730.46	GPHTS2215SR	Right Side Shaft
\$730.46	GPHTS2215SL	Left Side Shaft

GPHTS2215SR PARTS & KITS

EMPEROR SERIES FROM GENERAL PUMP

- **If replacing CAT 310/5CP2120W you may also want to order the following:**

\$19.01	GPP540015	Adapter Rail Kit
\$15.66	PU33000	24mm "H" Bushing
\$23.25	GPP540016	Rail Kit for CAT 530
\$6.67	GPO100216	Series 100 Oil - 16oz bottle
\$81.88	GPO100552	Series 100 Oil - 2½ gal



These innovative and patented pumps offer increased pump life and performance, making them perfect for the car wash industry!



GPHTCK4050S

EMPEROR SERIES FROM GENERAL PUMP

- 36 GPM @ 800 RPM, 1500 PSI
- 40.5 GPM @ 900 RPM, 1500 PSI
- Shaft OD: 40MM

\$3,731.77	GPHTCK4050S	Right Side Shaft
\$3,704.32	GPHTCK4050SL	Left Side Shaft

GPHTCK4050S OIL & KITS

EMPEROR SERIES FROM GENERAL PUMP

\$341.56	GPK2012	Valve Kit
\$346.55	GPK2013	Discharge Valve Kit
\$593.94	GPK2033	Hi-Temp Seal Kit
\$260.09	GPK2034	Packing Kit
\$75.19	GPO100450	2½ Gallon - 220 Oil

GPHTCK4050S CONVERSION PARTS

EMPEROR SERIES FROM GENERAL PUMP

If converting from CW1451 Pump you will need 1 of each of the parts in the chart below

\$21.50	GPPZUH40	Hub for Pump
\$28.60	GPPZUH178	Hub for Motor
\$263.81	GPPZP3B136	Pulley for Pump
\$94.86	GPPZP3B60	Pulley for Motor
\$51.87	GPP510476	1½" Hose Barb

AND choose (1) from the below:

\$151.63	GPPHT150CWS	If your pump is positioned above the motor on a PDQ Pump Stand
\$151.63	GPPHT150CWL	If your pump is positioned below the motor on a PDQ Pump Stand
\$109.22	GPPHT150RCK	If you are converting from a Cat 3535 to a HTCK4050S



PEHT PLATINUM SERIES PUMPS

EMPEROR SERIES FROM GENERAL PUMP

- Forged stainless steel manifold with a nickel plated crankcase, solid ceramic plungers, heavy-duty tapered roller bearings, and HT technology packings.
- **PRESSURE:** 3000 PSI
- **MAX. TEMP.:** 185°F

PRICE	PART #	SHAFT	GPM	RPM	HP
\$708.28	GPEHT2214SR	Right	4	950	5.2
\$708.28	GPEHT2214SL	Left			
\$708.29	GPEHT2010SR	Right	3.43-4	1450-1750	7-8.2
\$708.28	GPEHT2010SL	Left			
\$708.28	GPEHT2012SR	Right	2.64-4.76	950-1750	5.4-9.8
\$708.28	GPEHT2012SL	Left			
\$708.28	GPEHT2213SR	Right	3.43-5.55	950-1450	7-11.4
\$708.28	GPEHT2213SL	Left			



PEHT2214S PARTS & KITS

EMPEROR SERIES FROM GENERAL PUMP

\$25.14	GPPZBBH24	Pulley Bushing (Recommended)
\$130.42	GPP101112	SS Rail Kit for CAT 310/5CP Conversion

The PEHT2214S is a direct replacement for Cat 310/5CP2120W with the same RPM and flow

The PEHT2010S is a direct replacement for Cat 5CP2140 with the same RPM and flow

EMPEROR SERIES FROM GENERAL PUMP®



GPHTCK3623S

EMPEROR SERIES FROM GENERAL PUMP

- FLOW: 18/21/25 GPM
- RPM: 1000/1150/1350
- PSI: 1500/1300
- SHAFT OD: 30MM

\$2,954.60 GPHTCK3623S

GPHTCK3623S KITS & OIL

EMPEROR SERIES FROM GENERAL PUMP

\$640.82	GPK2030	Valve Kit
\$452.50	GPK212	High Pressure Seal Kit
\$233.40	GPK2032	High Temperature Packing Kit
\$75.19	GP0100450	2½ Gallon 220 Series Oil



HTF SERIES

EMPEROR SERIES FROM GENERAL PUMP

- SHAFT OD: 24MM

\$1,565.95	GPHTF2018S	GPM: 4.0/5.0/7.5
	GPHTF2018SL*	PSI: 3600 RPM: 950/1200/1750
\$1,565.95	GPHTF2221S	GPM: 8.5/10.2
	GPHTF2221SL*	PSI: 3000 RPM: 1450/1750
\$1,565.95	GPHTF2421S	GPM: 10.0/12.0
	GPHTF2421SL*	PSI: 3000/2500 RPM: 1450/1750

***Left Side Shafts**

HTF SERIES PUMP OILS

EMPEROR SERIES FROM GENERAL PUMP

\$6.67	GP0100216	Series 100 Oil - 16oz bottle
\$81.88	GP0100552	Series 100 Oil - 2½ gal.

GENERAL PUMP®



New!



EPHT SERIES

GENERAL PUMP

- New forged brass manifold, increases working pressure to 4,000 PSI

\$635.12	GPEPHT1810S	GPM: 3.3
	GPEPHT1810SL*	PSI: 4000/2465 RPM: 1450
\$560.91	GPEPHT1812S	GPM: 3.9
		PSI: 4000/2465 RPM: 1750
\$635.12	GPEPHT1813S	GPM: 3.4
	GPEPHT1813SL*	PSI: 4000/2465 RPM: 1450

***Left Side Shafts**

EPHT SERIES PUMP OIL

GENERAL PUMP

\$6.67	GP0100216	Series 100 Oil - 16oz bottle
\$81.88	GP0100552	Series 100 Oil - 2½ gal.

New!



PHTCK4050S PLUNGER PUMP

GENERAL PUMP

- SHAFT OD: 40MM
- MAX. TEMP.: 140 °F

\$3,704.32	GPPHTCK4050S	GPM: 45
	GPPHTCK4050SL*	PSI: 1500 RPM: 900

***Left Side Shafts**

PHTCK4050S PLUNGER PUMP OILS

GENERAL PUMP

\$49.15	GP0100016	Series 220 Oil - 16oz bottle
\$75.19	GP0100450	Series 220 Oil - 2½ gal.



GPCW2040 DUAL SHAFT PUMP GENERAL PUMP

- FLOW: 4.0/5.0 GPM • PSI: 2000/1500
- RPM: 1000/1250 • SHAFT OD: 24MM

\$576.92 GPCW2040

GPCW2040 PUMP KITS

\$42.50	GPK01	Valve Kit
\$6.66	GPK02	Piston Rod Oil Seal
\$15.88	GPK03	Crankshaft Oil Seal
\$75.83	GPK04	Valve Caps, O-Rings
\$23.25	GPK06	Plunger Repair Kit
\$83.95	GPK201	Valve Kit Hi-Temp
\$258.28	GPK220	Seal Packing Kit

GPCW2040 PUMP OIL

For series 100

\$6.67	GP0100216	16oz bottle
\$81.88	GP0100552	2½ gal.

GPCW2040 PUMP ACCESSORIES

\$48.49	GPK910	Low Pressure Assembly
\$38.90	GPK9101A	Packing Assembly: 3 needed per pump
\$66.33	GPK969	Packing Kit: High/Low Pressure



ET SERIES GENERAL PUMP

- Compact design, 5/8" hollow shaft, flanged for direct couple to electric motors (NEMA 56C), dust protection chamber, solid ceramic plungers with oversized plunger guide

PRICE	PART #	SHAFT	GPM	PSI	RPM
\$283.42	GPET1507E34	-	3.2	2610	3400



EP SERIES GENERAL PUMP

- 24 mm solid ceramic plungers with innovative dual guide system and guide bushing for superior performance

T-50 SERIES					
PRICE	PART #	SHAFT	GPM	PSI	RPM
\$339.75	GPEP1812S17L	Left	4.0	2500	1750
\$339.75	GPEP1812S17	Right	4.0	2500	1750
\$7.81	GPPZFEETEVO	Rail kit/mounting bracket			



T/TS-47 SERIES GENERAL PUMP

- Solid shaft pump. Heavy duty tapered roller bearings with oversized connecting rods. 24 MM shaft, forged brass manifold

PRICE	PART #	SHAFT	GPM	PSI	RPM
\$497.83	GPT1011L	Left	4.5 5.6	2000 1500	1125 1450
\$516.26	GPTS1011R	Right	4 4.75	2000 1500	1450 1750
\$545.34	GPTS1511	Right	4	3500	1450
\$545.34	GPTS1511L	Left	4	3500	1450
\$531.60	GPTSS1021L	Left	4.5 5.6	3000 1700	1125 1450
\$531.60	GPT1321L	Left	5.5	2100	1150
\$531.66	GPT1321R	Right	5.5	2100	1150
\$516.26	GPT921L	Left	5	1700	1050
\$539.92	GPTS1811	Right	4.5 4.0 5.0	3500 3500 3500	1450 1290 1610
\$539.92	GPTS1811L	Left	4.5 4.0 5.0	3500 3500 3500	1450 1290 1610
\$624.70	GPTS2011L	Left	4 4.75	3500 2300	1450 1750
\$624.70	GPTS2011R	Right	4 4.75	3500 2300	1450 1750
\$569.40	GPTS2021L	Left	4.5 5.6	3500 3500	1125 1450
\$569.40	GPTS2021R	Right	4.5 5.6	3500 3500	1125 1450
\$842.08	GPT9281	Right	4	4000	1750
\$842.08	GPT9281L	Left	4	4000	1750



EZ 44 SERIES GENERAL PUMP

- Hollow shaft pump for electric direct drive, NEMA 184TC mount motor, forged brass manifold, 1½" hollow shaft

PRICE	PART #	SHAFT	GPM	PSI	RPM
\$433.66	GPEZ2542E	Right	4.2	2500	1750
\$433.66	GPEZ2542EL	Left	4.2	2500	1750
\$433.66	GPEZ2536E	Right	3.6	2500	1750
\$433.66	GPEZ2536EL	Left	3.6	2500	1750

GP SERIES 100 PUMP INDUSTRIAL OIL GENERAL PUMP

\$6.67	GP0100216	16 oz. bottle
\$81.88	GP0100552	2½ gal



GENERAL PUMP® AND SUPPLIES



GPCW1012 & GPCW1012L

GENERAL PUMP

- FLOW: 12.0 GPM
- RPM: 900
- PRESSURE: 1000 PSI
- SHAFT OD: 35MM

\$1,619.24	GPCW1012	Right Shaft
\$1,619.24	GPCW1012L	Left Shaft
\$84.04	GPO100734	Series 8090 Oil

TO WATCH A VIDEO ABOUT THESE PUMPS VISIT OUR WEBSITE, OR SIMPLY SCAN THIS QR CODE WITH YOUR HANDHELD MOBILE DEVICE:



GPCW3040R

GENERAL PUMP

- FLOW: 5.0 GPM
- RPM: 1250
- PRESSURE: 3000 PSI
- SHAFT OD: 24MM

\$661.92	GPCW3040R	Right Shaft
-----------------	------------------	-------------

GPCW3040R OIL

GENERAL PUMP

\$6.67	GPO100216	Series 100 Oil - 16oz bottle
\$81.88	GPO100552	Series 100 Oil - 2½ gal



GPCW2004

GENERAL PUMP

- FLOW: 4.0 GPM
- RPM: 1750
- PRESSURE: 2000 PSI
- SHAFT OD: 24MM

\$671.06	GPCW2004	Right Shaft
\$671.06	GPCW2004L	Left Shaft

GPCW2004 OIL

GENERAL PUMP

\$6.67	GPO100216	Series 100 Oil - 16 oz bottle
\$81.88	GPO100552	Series 100 Oil - 2½ gal



GP INDUSTRIAL OIL

GENERAL PUMP

- Pump crankcase oil must be changed after an initial 50-hour break-in period. Oil must be changed every 3 months or 500 hour intervals thereafter

100 SERIES OIL

GENERAL PUMP®

- For use with these General Pumps:

All Emperor Series	
Except HTCK4050S and HTCK3623S	
All T50 Series	GPCW2040
All T47 Series	GPCW3040R

\$81.88	GPO100552	2½ Gallon
\$6.67	GPO100216	16 oz. bottle

8090 SERIES OIL

GENERAL PUMP®

- For use with these General Pumps:

GPCW61
GPCW1012L
GPCW61L

\$84.04	GPO100734	2½ Gal.
----------------	------------------	---------

220 SERIES OIL

GENERAL PUMP®

- For use with these General Pumps:

GPHTCK4050S
GPHTCK3623S

\$75.19	GPO100450	2½ Gal.
----------------	------------------	---------

OTHER GP KITS

GENERAL PUMP

\$44.44	GPK08	20MM High Pressure Seals
\$31.12	GPK28	20MM Packing Assembly
\$91.92	GPK80	45MM Packing Assembly



PULLEYS

GENERAL PUMP

\$43.03	GPP639015	1 Groove - 8" - 24MM
\$45.14	GPPZP140	2 Groove - 5½" - 24MM
\$45.14	GPPZP160	2 Groove - 6¾" - 24MM

PUMPS



CW2040

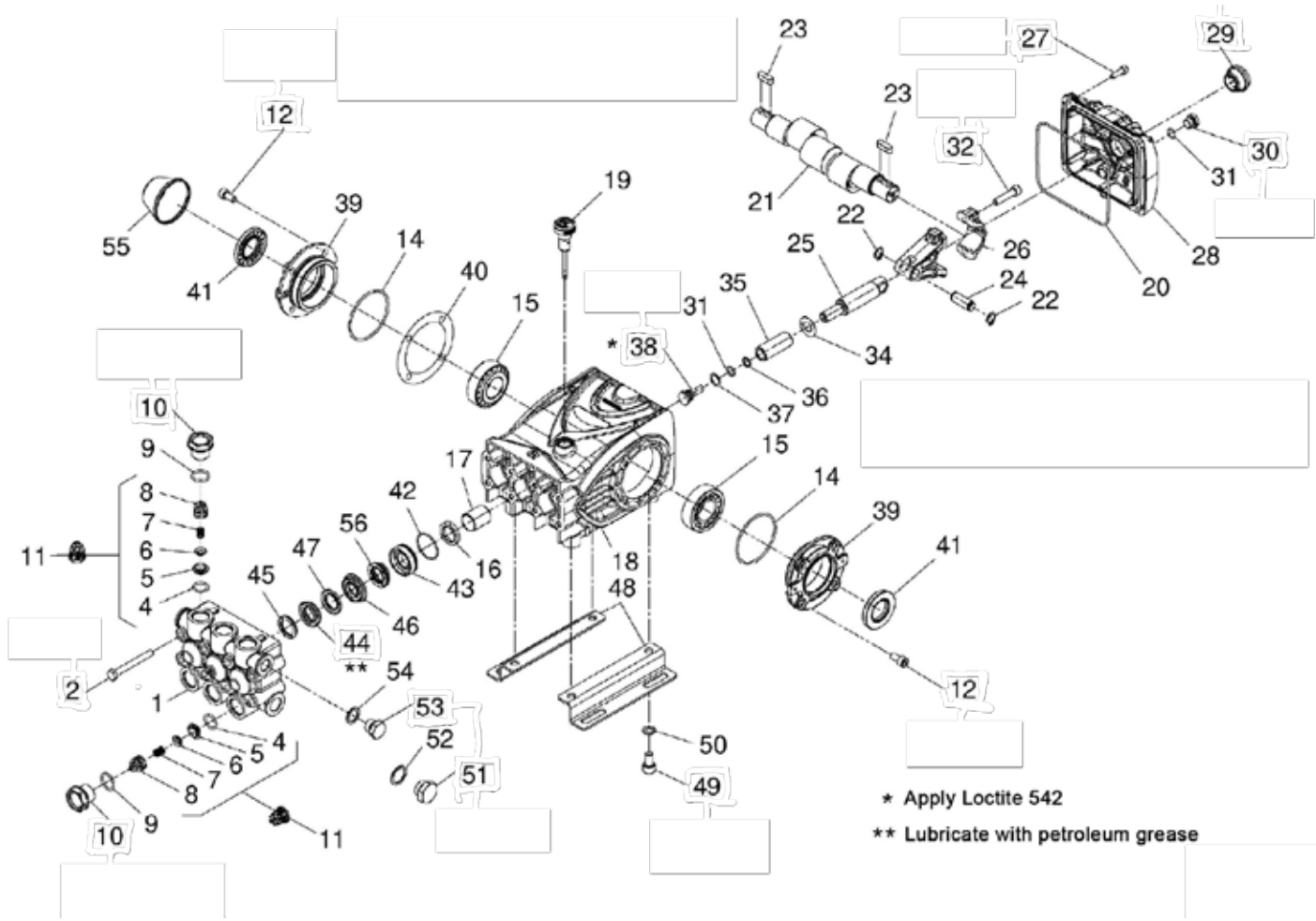

* Apply Loctite 542

** Lubricate with petroleum grease

PART LIST

No.	Part No.	Description	Qty.	No.	Part No.	Description	Qty.	No.	Part No.	Description	Qty.
1.	47120841	Manifold	1	21.	47020035	Crankshaft	1	40.	97567800	Shim	2
2.	99320600	Screw, M8 x 70	8	22.	90055700	Ring, Snap	6	41.	90164800	Seal, Oil	1
4.	90384100	O-ring, Ø17.13 x 2.62	8	23.	91487700	Key		42.	90361600	O-ring, Ø34.65 x 1.78	3
5.	36200366	Seat, Valve	6	24.	97738000	Pin, Wrist	3	43.	47080570	Retainer, packing	3
6.	36200176	Plate, Valve	6	25.	47050466	Guide, Plunger	3	44.	90270500	Packing	3
7.	94737600	Spring	6	26.	47030001	Connecting Rod	3	45.	47100051	Ring, Head, M20	3
8.	36200251	Guide, Valve	6	27.	99188400	Screw, M6x20	5	46.	47216970	Intermed. Ring	3
9.	90384700	O-ring, Ø20.29 x 2.62	6	28.	47160622	Cover, Crankcase	1	47.	90270400	Restop Ring	3
10.	98222000	Cap	6	29.	47221301	Oil Indicator	1	48.	47200074	Pump Feet	2
11.	36703201	Valve Assembly	6	30.	98204250	Plug	1	49.	99364400	Screw, M10 x 18	4
12.	99303900	Screw, M8 x 16	8	31.	90358500	O-ring, 10.82 x 1.78	4	50.	96710600	Washer, M10.2	4
14.	90391300	O-ring, Ø67.95 x 2.62	2	32.	99309900	Screw, M8 x 35	6	51.	98217600	Cap	1
15.	640047	Bearing, Roller	2	34.	96728600	Washer, M14	3	52.	96751400	Washer, M21.5	1
16.	90162500	Seal, Oil, Ø22 x 32 x 2.5	3	35.	47040409	Plunger, 20 mm	3	53.	98210000	Cap	1
17.	90912600	Bushing, Ø22 x 25 x 30	3	36.	90506700	Ring, Back-up	3	54.	96738000	Washer, M17.5	1
18.	47010822	Crankcase	1	37.	96728000	Washer	3	55.	47212451	Shaft Cover	1
19.	98210600	Oil Dip Stick	1	38.	47219566	Screw, Plunger	3	56.	90271000	Seal, Low Press, 20 mm	3
20.	90392200	O-ring, Cover	1	39.	47151022	Cover, Crankcase	13				

GENERAL PUMP® SUPPLIES, OIL & KITS FROM KLEEN-RITE



REPAIR KIT FOR GENERAL PUMP EZ3040G

KLEEN-RITE KITS

• KIT WILL SERVICE EZ3040G PUMPS

- Packing assemblies, valves, and oil are genuine General Pump® replacement parts
- (1) K88 Seal Kit
- (1) 100216 16 oz. General Pumps® Oil
- (1) K123 Valve Kit
- (1) 36H993 Large Size Coated Nitrile Gloves

\$85.72 KRK2201



REPAIR KIT FOR GENERAL PUMP EZ4040G

KLEEN-RITE KITS

• KIT WILL SERVICE EZ4040G PUMPS

- Packing assemblies, valves, and oil are genuine General Pump® replacement parts
- (1) K153 Seal Kit
- (1) 100216 16 oz. General Pumps® Oil
- (1) K123 Valve Kit
- (1) 36H993 Large Size Coated Nitrile Gloves

\$135.17 KRK2202



REPAIR KIT FOR GENERAL PUMP TS1511 & TS2021

KLEEN-RITE KITS

• KIT WILL SERVICE TS1511 & TS2021 PUMPS

- Packing assemblies, valves, and oil are genuine General Pump® replacement parts
- (1) K69 Packing Kit
- (3) 100216 16 oz. General Pumps® Oil
- (1) K01 Valve Kit
- (1) 36H993 Large Size Coated Nitrile Gloves

\$101.14 KRK2203



REPAIR KIT FOR GENERAL PUMP TS1511 & TS2021 WITH BRASS

KLEEN-RITE KITS

• KIT WILL SERVICE TS1511 & TS2021 PUMPS WITH BRASS

- Packing assemblies, valves, and oil are genuine General Pump® replacement parts
- (3) K28 Packing Kit
- (3) 100216 16 oz. General Pumps® Oil
- (1) K01 Valve Kit
- (1) 36H993 Large Size Coated Nitrile Gloves

\$123.75 KRK2204

PENTAIR HYPRO PUMP ACCESSORIES



PULSE HOSE

PENTAIR HYPRO ACCESSORIES

- Quality pulsation dampener hoses constructed of special Hi-Flex horizontally-braided hose.
- **MAX. PRESSURE:** 1500 PSI
- **MEASUREMENTS:** 3/8" x 24"

\$26.18 HYP33750012



PUMP OIL

PENTAIR HYPRO ACCESSORIES

- Specially-formulated SAE 30 weight, non-detergent, high-grade oil
- Reduces scuff and wear in diaphragm, piston, and plunger pumps
- Inhibits moisture that causes damage
- Prevents oxidation that could lead to sludge formation
- Resists foaming and aeration that can cause equipment to operate erratically and oil to oxidize
- Provides smooth pump operation in a variety of temps.

\$11.77 HY00038 1 Quart

ALL PENTAIR BRANDS ARE TRADEMARKS OF PENTAIR.

PUMPS



GIANT PLUNGER PUMPS

PLUNGER PUMPS

- Ceramic plungers
- Stainless steel and brass wetted parts
- Dipstick for easy oil level inspection
- Large drain plug for easy oil change and maintenance
- Self-adjusting, spring-loaded Packings
- Corrosion-resistant Hastalloy valves for longer life
- Heavy-duty ball bearings
- Mounting rails are not included with pumps
- Brass or aluminum/bronze fluid ends
- Compact design for easy fit
- Die-cast aluminum crankcase

PUP318AL & PUP318AR

GIANT PLUNGER PUMPS



- Specs when used at a **LOWER** GPM
- **FLOW:** 4.8 GPM
- **DISCHARGE:** (2) 3/8" BSP
- **PRESSURE:** 2000 PSI
- **INLET:** (2) 1/2" BSP
- **RPM:** 1450
- Specs when used at a **HIGHER** GPM
- **FLOW:** 5.8 GPM
- **DISCHARGE:** (2) 3/8" BSP
- **PRESSURE:** 1000 PSI
- **INLET:** (2) 1/2" BSP
- **RPM:** 1750

\$543.87	PUP318AL	Left Shaft
\$540.14	PUP318AR	Right Shaft

PUP318AL & PUP318AR KITS

GIANT PLUNGER PUMPS

\$50.64	PU09145	Plunger Packing
\$56.38	PU09116	Valve Kit
\$28.92	PU01161	Rails



PUP420A

GIANT PLUNGER PUMPS

- **MAX FLOW:** 12.8 GPM
- **DISCHARGE:** (2) 3/4" NPT
- **MAX PRESSURE:** 2175 PSI
- **INLET:** (2) 1" NPT
- **MAX RPM:** 1450

\$1,314.29	PUP420AL	Left
\$1,408.24	PUP420AR	Right

PUP420A REPAIR KITS

GIANT PLUNGER PUMPS

\$122.41	PU09140	Plunger Packing
\$273.38	PU09143	Valve Kit
\$44.46	PU07358	Rails



PULP122

GIANT LP SERIES PUMPS

- **MAX FLOW:** 35.4 GPM
- **MANIFOLD:** Alum/Bronze
- **INLET:** (2) 1 1/2" NPT
- **MAX PRESSURE:** 1300 PSI
- **MAX RPM:** 800
- **DISCHARGE:** (2) 1" NPT

\$4,158.07	PULP122	USES RECLAIMED WATER
-------------------	----------------	-----------------------------

PULP122 KITS

GIANT LP SERIES PUMPS

\$268.63	PU09477	Plunger Packing
\$268.85	PU09136	Valve Kit



PULP123

GIANT LP SERIES PUMPS

- **MAX FLOW:** 35.4 GPM
- **MAX RPM:** 800
- **MAX PRESSURE:** 1300 PSI
- **INLET:** (2) 1 1/2" NPT
- **MAX TEMP:** 140° F.
- **DISCHARGE:** (2) 1" NPT
- **MANIFOLD:** Brass

\$3,529.76	PULP123	USES FRESH WATER
-------------------	----------------	-------------------------

PUP220E SERIES



- Can include flange and coupler for direct mounting, direct drive fits 184TC face motor
- **MAX FLOW:** 4.7 GPM
- **MAX RPM:** 1750
- **MAX PRESSURE:** 2000 PSI
- **INLET:** (2) 1/2" BSP
- **MAX TEMP:** 160° F
- **DISCHARGE:** (2) 3/8" BSP

\$405.06	PUP220R	Right Shaft	184TC motor
\$405.06	PUP220L	Left Shaft	184TC motor
\$430.96	PUP220LE1B	Left Shaft	56C Electric Motor • 5/8"
\$430.96	PUP220RE1B	Right Shaft	56C Electric Motor • 5/8"
\$499.27	PUP220RE1BUT	Right Shaft	56C Electric Motor • 5/8" with Unloader, Thermal
\$445.09	PUP220RE2F	Right Shaft	56C Electric Motor • 1 1/8"
\$445.09	PUP220RE2	Right Shaft	TC Face Electric Motor
\$445.09	PUP220RE2F	Right Shaft	TC Face Electric Motor • 1 1/8"
\$506.32	PUP220RE2FU	Right Shaft	TC Face Electric Motor • 1 1/8" with Unloader
\$511.03	PUP220RE2FU3T	Right Shaft	TC Face Electric Motor • 1 1/8" with Unloader 2.1mm Fixed Siphon Injector, Thermal



PUP220E KITS

GIANT PUMPS

\$59.57	PU09164	Plunger Packing
\$56.38	PU09116	Valve Kit

GIANT PLUNGER PUMPS & PARTS



PUP46W
GIANT PUMPS

- MAX FLOW: 3.9 GPM
- MAX TEMP: 160° F.
- INLET: (2) 1/2" BSP
- MAX PRESSURE: 2200 PSI
- MAX RPM: 1420
- DISCHARGE: (2) 3/8" BSP

\$522.70 PUP46W

PUP46W KITS
GIANT PUMPS

\$114.38	PU09081	Plunger Packing
\$134.70	PU09039	Valve Kit
\$50.28	PU01075	Rails



PUP55W
GIANT PUMPS

- MAX FLOW: 4.9 GPM
- MAX TEMP: 160° F.
- INLET: (2) 1/2" NPT
- MAX PRESSURE: 2320 PSI
- MAX RPM: 1750
- DISCHARGE: (2) 3/8" NPT

\$762.82 PUP55W

PUP55W KITS
GIANT PUMPS

\$113.75	PU09089	Plunger Packing
\$119.15	PU09041	Valve Kit
\$50.28	PU01075	Rails



PUP56W
GIANT PUMPS

- MAX FLOW: 6.1 GPM
- MAX TEMP: 160° F.
- INLET: (2) 1/2" NPT
- MAX PRESSURE: 1900 PSI
- MAX RPM: 1420
- DISCHARGE: (2) 3/8" NPT

\$743.59 PUP56W

PUP56W KITS
GIANT PUMPS

\$119.99	PU09061	Plunger Packing
\$119.15	PU09041	Valve Kit
\$50.28	PU01075	Rails



PUP470
GIANT PUMPS

- MAX FLOW: 18.4 GPM
- MAX RPM: 1450
- MAX PRESSURE: 2030 PSI
- INLET: (1) 1" BSPP & (2) X 3/4" BSPP
- MAX TEMP: 160° F.
- DISCHARGE: (2) 3/4" BSPP

\$1,688.54 PUP470R Right Shaft
\$1,688.54 PUP470L Left Shaft



PUP536
GIANT PUMPS

- MAX FLOW: 26.4 GPM
- MAX RPM: 1450
- MAX PRESSURE: 1740 PSI
- INLET: (2) 1" BSP
- MAX TEMP: 104° F.
- DISCHARGE: (2) 3/4" BSP

\$8,294.80 PUP536R Right Shaft
\$8,294.80 PUP536L Left Shaft



STAINLESS STEEL ACCUMULATOR
GIANT PUMPS



\$143.90	PU22050-38	12 GPM	3000 PSI	3/8" FNPT
\$127.78	PU22050	12 GPM	3000 PSI	1/2" MNPT
\$141.13	PU22155	30 GPM	3000 PSI	3/4" MNPT



GIANT PUMPS CRANKCASE OIL
GIANT PUMPS



\$42.25	PU01154	1 Gallon 80-90
\$12.62	PU01153	1 Quart 20W-50

20W-50

View our complete listing of Giant Pump parts and accessories at

KLEENRITE.COM



THERMAL RELIEF VALVES
GIANT PUMPS



\$6.00	PU23420	1/4"	140°
\$6.00	PU23421	3/8"	140°
\$5.77	PU23422	1/2"	140°

FEATURED PRODUCT

HYDRA-CELL PUMPS FROM WANNER ENGINEERING, INC.

Hydra-Cell positive displacement pumps have an incredibly efficient design that nearly eliminates maintenance and helps the pumps last longer – even when processing difficult liquids that contain abrasives and particulates! Each Hydra-Cell pump is engineered without seals, packing or cups, and boast hydraulically balanced diaphragms that aren't stressed while flexing.

- Made with tough, durable materials
- Virtually no maintenance: low stress, hydraulically balanced, sealless design
- Highly efficient with low power consumption
- Self-priming
- Capable of running dry
- Handles the full spectrum of low - high viscosity fluids
- Low vibration often eliminates the need for pulsation dampeners

KEY DETAILS OF HYDRA-CELL DISPLACEMENT PUMPS

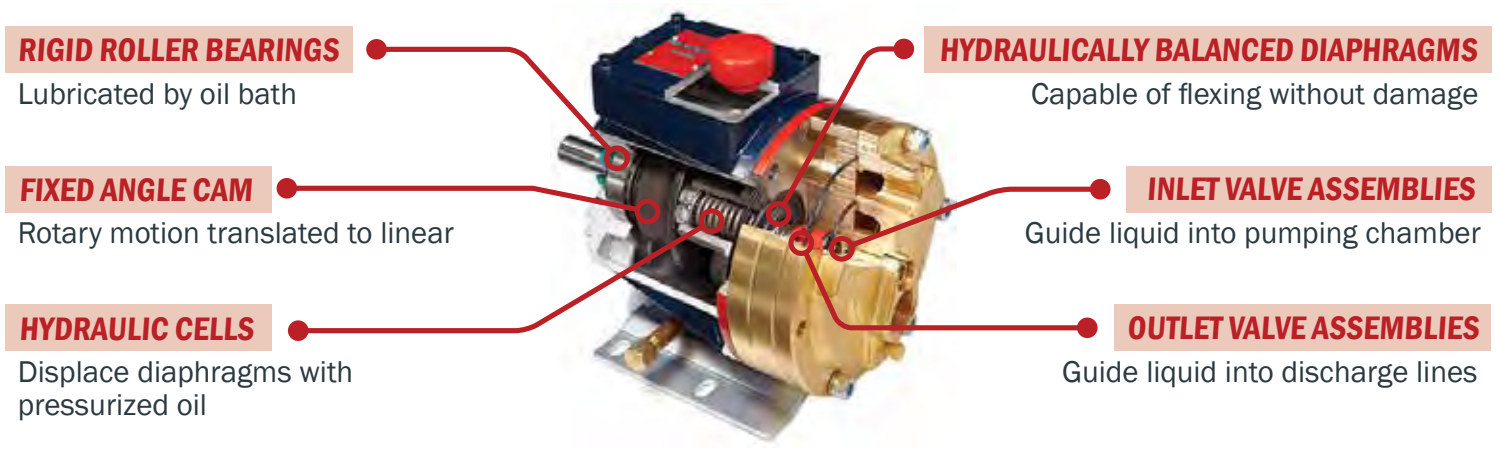

RIGID ROLLER BEARINGS

Lubricated by oil bath

HYDRAULICALLY BALANCED DIAPHRAGMS

Capable of flexing without damage

FIXED ANGLE CAM

Rotary motion translated to linear

INLET VALVE ASSEMBLIES

Guide liquid into pumping chamber

HYDRAULIC CELLS

Displace diaphragms with pressurized oil

OUTLET VALVE ASSEMBLIES

Guide liquid into discharge lines

HYDRA-CELL SERIES OPTIONS

Hydra-Cell pumps are useful in applications like car washes, agriculture, and landscaping. There are several different series of Hydra-Cell pumps available that satisfy different pressure and flow rate needs. Popular series include the H-25 Series and the D-10 Series.

H-25 SERIES PUMP



- **FLOW:** 20 GPM
 - **PRESSURE:** 1000 PSI
 - **INLET:** 1½" NPT
 - **OUTLET:** 1" NPT
 - **MAX. TEMP:** 180° F
- H25XKBTHFECA MODEL SHOWN

D-10 SERIES PUMP



- **FLOW:** 8.8 GPM
 - **PRESSURE:** 1000 PSI
 - **INLET:** 1" NPT
 - **OUTLET:** 3/4" NPT
 - **MAX. TEMP:** 180° F
- D10EKBTHFECA MODEL SHOWN

FEATURED PRODUCT

HYDRA-CELL PUMPS

HYDRA-CELL[®]
SEAL-LESS PUMP TECHNOLOGIES

HYDRA-CELL PUMPS

WANNER ENGINEERING

• For difficult solutions like reclaim water, wettable powders, slurries & abrasives. Solutions never come in contact with pumping mechanisms. Diaphragm design has no cups, packing or mechanical seals

- American made
- Positive displacement pumps
- Can be run dry without damage
- Hydraulically balanced diaphragms
- Timken roller bearings
- Shaft direction can be in either direction for easy mounting
- Brass pump heads
- Buna-N elastomers
- Stainless steel valves, seats, & valve springs



D35-X

HYDRA-CELL PUMPS

- **MAX FLOW:** 37.0 GPM
- **MAX RPM:** 1050
- **INLET:** 2½" NPT
- **MAX PRESSURE:** 1250 PSI
- **SHAFT DIAMETER:** 2"
- **OUTLET:** 1¼" NPT
- **MAX TEMP:** 180° F.
- **SHAFT ROTATION:** Bi-directional
- **WEIGHT:** 240 lbs.

\$6,333.54	WPD35XKBTH	Pump
\$675.02	D35K52THFEC	Repair Kit



D10-X (BELT DRIVEN)

HYDRA-CELL PUMPS

- **MAX FLOW:** 8.1 GPM
- **MAX RPM:** 1450
- **INLET:** 1" NPT
- **MAX PRESSURE:** 1000 PSI
- **SHAFT DIAMETER:** 7/8"
- **OUTLET:** 3/4" NPT
- **MAX TEMP:** 180° F.
- **SHAFT ROTATION:** Bi-directional
- **WEIGHT:** 48 lbs.

\$1,527.50	D10XKBTHFECA	Pump
\$246.88	D10K52THFEC	Repair Kit



D10-E (DIRECT DRIVE)

HYDRA-CELL PUMPS

- **MAX FLOW:** 8.8 GPM
- **MAX RPM:** 1750
- **INLET:** 1" NPT
- **MAX PRESSURE:** 1000 PSI
- **SHAFT DIAMETER:** 7/8"
- **OUTLET:** 3/4" NPT
- **MAX TEMP:** 180° F.
- **SHAFT ROTATION:** Bi-directional
- **WEIGHT:** 48 lbs.

\$1,527.50	WPD10EKBTH	Pump
\$246.88	D10K52THFEC	Repair Kit



H25-X

HYDRA-CELL PUMPS

- **MAX FLOW:** 20 GPM
- **MAX RPM:** 1050
- **INLET:** 1½" NPT
- **MAX PRESSURE:** 1000 PSI
- **SHAFT DIAMETER:** 1½"
- **OUTLET:** 1" NPT
- **MAX TEMP:** 180° F.
- **SHAFT ROTATION:** Bi-directional
- **WEIGHT:** 125 lbs.

\$3,637.93	WPH25XKBTH	Pump
\$406.26	D25K52THFEC	Repair Kit



Hydra-Cell positive displacement pumps feature a seal-less pumping chamber so there are no seals, packing or cups to leak or replace.

The seal-less design and check valves enable Hydra-Cell to handle abrasives and particulates that would damage other types of pumps.



HYDRA-OIL

HYDRA-CELL PUMPS

\$16.86	WPOA011143430	1 Qt
\$112.96	WPOA011143432	2½ Gal

PUMPS



UDOR PUMPS

New!



UDPND3020S

PRICE	KR #	GPM	PSI	RPM	CRANK SHAFT
\$308.20	UDPND3020S	3.0	2030	1750	Solid
\$332.60	UDPND3020Z	3.0	2030	1750	Hollow
\$332.60	UDPNL3020T	3.0	2030	3400	Hollow
\$332.60	UDPNL2020Z	2.0	2030	3400	Hollow

OIL SEAL KIT	VALVE KIT
UD606107	UD606101
UD606107	UD606101
UD606107	UD606101
UD606107	UD606101



UDBC1520S

\$399.35	UDBC1520S	4.0	2900	1450	Solid
\$417.01	UDBC1820S	4.9	2900	1450	Solid

UD606128	UD606102
UD606128	UD606102



UDBD4030S

\$399.35	UDBD4030S	4.1	2900	1750	Solid
\$441.15	UDBD4030U	4.1	2900	1750	Hollow
\$559.67	UDBD40L	4.1	2900	1750	Hollow

UD6061B2	UD606102
UD6061B2	UD606102
UD6061B2	UD606102



UDBKC1530S

\$458.85	UDBD5030U	5.0	2900	1750	Hollow
----------	-----------	-----	------	------	--------

UD606128	UD606102
----------	----------

\$473.93	UDBKC1530S	4.0	4350	1450	Solid
\$492.27	UDBKC1825S	4.9	3625	1450	Solid
\$500.78	UDBKC2125S	5.5	3625	1450	Solid
\$491.63	UDBKD5036S	4.8	3650	1750	Solid

UD606128	UD606130
UD606128	UD606130
UD606128	UD606130
UD606128	UD606130



UDBKC1530S

\$545.18	UDBKD4044S	4.0	4350	1750	Solid
\$481.09	UDBKL4044W	4.0	4350	3400	Hollow

UD6061B2	UD606130
UD6061B2	UD606130



UDBKL4044W

\$964.11	UDCKC3820S	10.0	3000	1450	Solid
\$964.11	UDCKC3820SL	10.0	3000	1450	Solid
\$902.29	UDCKC4220S	11.6	2900	1450	Solid

UD606112	UD606103
UD606112	UD606103
UD606112	UD606103

New!



Triple Diaphragm Pumps					
PRICE	KR #	GPM	PSI	RPM	CONFIG.
\$1,148.17	UDZ40P	10.5	-	540	Universal VA Drive Face
\$1,447.36	UDZ40PGR	10.5	300	540	Gear Reduction for 3/4" Shaft Gas Engine, 4-6.5 HP
\$1,306.76	UDZ85P	22.0	300	550	Universal VA Drive Face
\$1,521.46	UDZ85PGR5	22.0	300	540	Gear Reduction for 3/4" Shaft Gas Engine, 4-6.5 HP

DIAPHRAGM KIT	COMPLETE KIT
UD606297	UD870060-CK
UD606297	UD870060-CK
UD606297	UD870060-CK
UD606297	UD870060-CK

New!



06-UBI22 MONO-BLOCK UNLOADER

- GPM: 5
- PSI: 3000
- INLET: 1/2" Female
- OUTLET: 3/8" Male

\$102.98 UDUBI22 M Series with Injector

New!



CASE ROD OIL SEAL

\$12.75 UD000743



ARIMITSU PUMPS CONVERSION KITS



ARIMITSU 313 SELF SERVE ARIMITSU PUMPS

- Includes 313 pump rails
- 7.2" single groove pulley
- 4.0 GPM @ 1050 RPM, 0-1500 PSI

CALL	ARM61000	Left Shaft
	ARM61001	Right Shaft

MODEL 313 KITS ARIMITSU PUMPS

\$97.30	ARM30108	Valve Kit (3 valves per kit)
\$91.14	ARM30114	Seal Kit



ARIMITSU 516 SELF SERVE ARIMITSU PUMPS

- Includes 516 pump rails
- 8" single groove pulley
- 4.0 GPM @ 950 RPM, 0-2300 PSI
- 5.0 GPM @ 1200 RPM, 0-2000 PSI

\$978.38	ARM61002	Left Shaft
\$978.37	ARM61003	Right Shaft

MODEL 516 KITS ARIMITSU PUMPS

\$127.49	ARM30101	Valve Kit (3 Valves Per Kit)
\$110.57	ARM30100	Seal Kit



ARIMITSU 508 PREP STAND ARIMITSU PUMPS

- Includes 508 pump rails
- 9.75" double groove pulley
- 8.0 GPM @ 950 RPM, 0-1200 PSI
- 10.0 GPM @ 1200 RPM, 0-1000 PSI

\$1,082.23	ARM61004	Left Shaft
\$1,053.07	ARM61005	Right Shaft

MODEL 508 KITS ARIMITSU PUMPS

\$194.59	ARM30111	Inlet Valve Kit
\$155.55	ARM30112	Outlet Valve Kit
\$112.85	ARM30110	Seal Kit

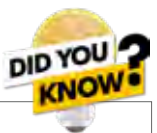

Arimitsu Pumps offer premium-quality pumps known to be quiet, durable, and compact resulting in lower energy consumption, quieter equipment rooms, and lower cost of ownership than other brands.



<https://www.facebook.com/arimitsupumpsofnorthamerica/photos>



ARIMITSU PUMPS & ACCESSORIES

New!



FOAM AND WAX APPLICATOR PUMP

ARIMITSU PUMPS

- 2 GPM @ 80 PSI
- 120V motor
- FKM seal provides superior longevity when used with foams and waxes

\$396.96 ARM8090

New!



MODEL 510 DIRECT DRIVE PUMP AND BALDOR MOTOR

ARIMITSU PUMPS

- 7.5 GPM @ 1200 PSI
- RPM: 1800
- MAX TEMP: 175 °F
- Motor: Baldor 5HP/Phase 3
- 230V/460V 3 phase motor
- Inlet: 3/4"
- Outlet: 1/2" and 3/8"

\$2,386.65 ARM510R-A Right Pump
\$2,386.65 ARM510L-A Left Pump



MODEL 313

ARIMITSU PUMPS

- 4 GPM @ 1050 RPM, 0-1500 PSI
- Compact, quiet, durable
- Ideal for self-serve equipment
- 310/5CP replacement rails available

\$705.32 ARM313R Right Pump
\$705.32 ARM313L Left Pump

MODEL 313 KITS

ARIMITSU PUMPS

\$97.30 ARM30108 Valve Kit (3 valves per kit)
\$91.14 ARM30114 Seal Kit



MODEL 508

ARIMITSU PUMPS

- 8 GPM @ 950 RPM, 0-1200 PSI
- 10 GPM @ 1200 RPM, 0-1000 PSI
- Quiet, compact, long-lasting
- Ideal for dual-gun prep. units
- 7CP replacement rails available

\$886.69 ARM508R Right Pump
\$886.69 ARM508L Left Pump

MODEL 508 KITS

ARIMITSU PUMPS

\$194.59 ARM30111 Inlet Valve Kit
\$155.55 ARM30112 Outlet Valve Kit
\$112.85 ARM30110 Seal Kit



MODEL 516

ARIMITSU PUMPS

- 4 GPM @ 950 RPM, 0-2300 PSI
- 5 GPM @ 1200 RPM, 0-2000 PSI
- Powerful, quiet, heavy-duty
- Ideal for truck wash or super self serve bays
- 310/5CP replacement rails available

\$941.78 ARM516R Right Pump
\$941.78 ARM516L Left Pump

MODEL 516 KITS

ARIMITSU PUMPS

\$127.49 ARM30101 Valve Kit (3 valves per kit)
\$110.57 ARM30100 Seal Kit



32 OZ. PUMP OIL

ARIMITSU PUMPS

- For use with all model Arimitsu pumps
- ISO100 Premium

\$24.66 ARM30103

ARIMITSU PUMPS

Arimitsu Pumps are perfect in applications that require low noise, compact size and durability.



PULSAFEEDER PUMPS, PARTS & KITS



PULSATRON SERIES A PLUS PULSAFEEDER METERING PUMPS



- Reliable metering performance
- Rated "hot" for continuous duty
- High viscosity capability
- Leak-free, sealless, liquid end
- 1/4" x 3/8" OD tubing
- 1/4" FNPT piping
- 125 strokes per minute

PRICE	PART #	GPH	GPD	LPH	PSI
\$427.11	PFLB03	0.50	12	1.9	150
\$380.70	PFLB04	1.00	24	3.8	100
\$433.51	PFLB64	1.25	30	4.7	100
\$422.41	PFLB64SAPHC1	1.25	30	4.7	100



PULSATRON SERIES C PULSAFEEDER METERING PUMPS

- Reliable metering performance
- Rated "hot" for continuous duty
- High viscosity capability
- Leak-free, sealless, liquid end
- 1/4" x 3/8" OD tubing
- 1/4" FNPT piping

PRICE	PART #	GPH	GPD	LPH	PSI
\$346.23	PFLD03EA*	0.50	12	1.9	80
\$334.29	PFLC54SAVTC1	1.25	30	4.7	80

***INCLUDES EXTERNAL PACING INPUT**

PULSATRON INJECTION CHECK VALVE

PULSAFEEDER

- For Pulsatron and other pumps with end codes **PTC1, PTC2, PTCH, PTCJ**
- 3/8" OD tubing connection fitting with coupling nut
- 1/2" NPT male connection for the injection point

PRICE	PART #	SEAT
\$76.40	PFJ41766	FPP/HYP construction with ceramic ball
\$67.67	PFJ41996	PVC/TFE construction with ceramic ball
\$80.13	PFJ61098	FPP/FTF construction with ceramic ball



PULSATRON VALVE ASSEMBLIES

PULSAFEEDER

- Suction type valves install on the lower part of metering pump heads
- Discharge type valves install on the upper part of metering pump heads
- Bleed type valves attach to the discharge valve to facilitate pump priming

PRICE	PART #	TYPE	FOR WET END
\$32.27	PFL3101HC1	Suction	PHC1
\$44.00	PFL3101TC1	Suction	PTC1
\$44.00	PFL3101TC1-PVC	Suction	VTC1
\$44.00	PFL3101TC3	Suction	PTC3
\$32.27	PFL3102HC3	Suction	PHC3
\$32.27	PFL3201HC1	Discharge	PHC1
\$32.27	PFL3201HC3	Discharge	PHC3
\$44.00	PFL3201TC1	Discharge	PTC1
\$44.00	PFL3201TC1-PVC	Discharge	VTC1
\$58.40	PFL3300H01-FPP	Bleed	PHC1
\$58.40	PFL3300H03-PVC	Bleed	VHC3, WHC3
\$58.40	PFL3300T01	Bleed	PTCH, PTCJ, PTC1, PTT1
\$58.40	PFL3300T03	Bleed	PTCA, PTC3, PTS3, PTT3

PULSATRON KOPKIT REPAIR KITS

PULSAFEEDER

- A KOPkit is the best way to ensure proper maintenance of your Pulsafeeder metering pump
- Includes pump head assembly with valve, diaphragm, head screws, washers and an exploded view assembly drawing
- All listed kits include ceramic balls and tubing connection

PRICE	PART #	HEAD	SEATS/O-RINGS	SUCTION/DISCHARGE
\$84.73	PFK2PHC1	Size 2, GFPP	CSPE	.25" x .38"
\$98.00	PFK3PTC1	Size 3, GFPP	TFE	.25" x .38"
\$98.00	PFK4PHC1	Size 4, GFPP	CSPE	.25" x .38"
\$115.53	PFK4PTC1	Size 4, GFPP	TFE	.25" x .38"
\$133.73	PFK4PVC1	Size 4, GFPP	Viton	.25" x .38"
\$115.53	PFK4VTC1	Size 4, PVC	TFE	.25" x .38"
\$133.73	PFK6PHC3	Size 6, GFPP	CSPE	.38" x .50"
\$133.73	PFK6PTC3	Size 6, GFPP	TFE	.38" x .50"
\$115.73	PFKX100-AAAA	KOP Kit for .100, 150, 200 Pumps w/ AAAA Wet End Kits		

PULSATRON PARTS FOR 150 PSI MODELS

PULSAFEEDER

\$49.07	PFL0200300	PVC Head
----------------	-------------------	----------

ELECTRONIC CONTROL BOARDS

PULSAFEEDER

\$133.87	PFL9906201-000	Dual Function 115V, for all LD and LB Models, and LE02, 03, 12, 13, 14, 34, 33, 44
-----------------	-----------------------	--

COMET PUMPS



COMET HIGH PRESSURE PLUNGER PUMPS

COMET POWER WASH SPRAY PUMPS

PRICE	PART #	MODEL #	GPM	PSI	RPM	GAS HP	ELECTRIC HP	SEAL KIT	VALVE KIT
\$584.93	CP64100500	FW25530S	5.5	3000	1450	10.5	11.3	CP50190219	CP50250011
\$859.03	CP65120100	TWN6036S	6	3600	1000	19.6	14.8	CP50190646	CP50250020
\$859.03	CP65120300	TWN8025S	8	2500	1000	18.2	13.7	CP50190647	CP50250020
\$1,238.59	CP65131201	TW11025S	11	2500	1450	25	18.8	CP50190663	CP50250020
\$1,054.92	CP65140900	TWS13020S	13	2000	1750	23.7	17.9	CP50190647	CP50250020
\$623.27	CP65170900	RW6030S	6.2	3000	1450	16.9	12.7	CP50190672	CP50250025



PUMPS

Blue-White
CHEM-FEED

BLUE-WHITE® PUMPS



C-1500N SERIES INJECTION METERING PUMPS

BLUE-WHITE PUMPS

- Ideal for dispensing precise amounts of various solutions with easy to adjust feed rate
- Weather-resistant housing for indoor or outdoor use
- Includes: 5' suction tubing with flow indicator, 5' discharge tubing, mounting hardware, foot valve and injection fitting

C-1500 STANDARD FEATURES:

- FKM O-ring & PTFE/EP diaphragm
- PVDF suction (foot) valve with FKM and TFE/P O-rings, ceramic check ball and removable polypropylene filter screen

SPECIFICATIONS

- **STROKE:** .055" • **MAX FLOW:** 26.6 GPD • **VOLTAGE:** 115V
- **MAX PRESSURE:** 125 PSI • **MAX TEMP:** 130°F • **RPM:** 45

\$411.80	BW15N202X	2.4 oz./minute	\$411.80	BW15N304X040V7	.51 oz./minute
\$411.80	BW15N302X	2.7 oz./minute	\$411.80	BW15N332X	2.7 oz./minute
\$411.80	BW15N302X066	1.4 oz./minute	\$411.80	BW15N332X066V7	1.4 oz./minute
\$411.80	BW15N402X	5.9 oz./minute	\$411.80	BW15N432X24V	5.9 oz./minute
\$411.80	BW15N404X	10.6 oz./minute			

C-1500N SERIES INJECTION METERING PUMPS PARTS

BLUE-WHITE PUMPS

\$53.64	BWK406VT	Diaphragm Kit - FKM/PTFE
\$91.94	BWPK5686A	Bullet Valve - Pack of 2
\$41.72	BWPC395N6A	Polypropylene Injection Check Valve - for 3/8" tubing
\$33.20	BWP340N6V	Foot Valve 3/8" O.D.



BWPK568V1



BWPC5606V



BWP340N6V



BWPC395N6A



BWK406VT



BWP7618
(10 FOOT LENGTH)

PUMP PARTS & ACCESSORIES

BLUE-WHITE PUMPS

\$53.64	BWK406VT	FKM/PTFE Diaphragm Kit for 1500N
\$33.20	BWP340N6V	Foot Valve - 3/8" O.D. (C-340A)
\$25.54	BWPC5606V	3/8" O.D. Adapter - FKM O-Ring Housing
\$21.96	BWPK568V1	Bullet Valve (sold in single packs) (K-568A)
\$35.76	BWP7618	10' Tubing With Flow Indicator - 3/8" O.D.
\$26.38	BWP7638	5' Tubing With Flow Indicator - 3/8" O.D.
\$41.72	BWPC395N6A	Polypropylene Injection Check Valve for 3/8" tubing

C-1700N SERIES PUMP PARTS

BLUE-WHITE PUMPS

\$41.72	BWPC395N6A	Polypropylene Injection Check Valve - for 3/8" tubing
\$53.64	BWK406VT	Diaphragm Kit FKM/PTFE
\$91.94	BWPK5686A	Bullet Valve - Pack of 2



Established in 1957, Blue-White started out with a focus on the pool industry, but has grown over time to become a leading innovator in pumps for all purposes. All Blue-White Industries products are proudly made in the United States, at their central manufacturing facility in California. With in-house CNC capabilities and multiple Quality Assurance departments, Blue-White brings you homegrown quality you can count on!

ETATRON PUMPS



ELECTRIC DIAPHRAGM METERING PUMP

ETATRON FROM DILUTION SOLUTIONS

Dilution
SOLUTIONS

- Ideal for dispensing precise amounts of various solutions
- Simple-to-use, highly reliable and provides a compact design
- Great for accurate injections with presoaks, detergents, waxes and drying aids
- Unique one-piece Teflon® diaphragm

STANDARD FEATURES:

- Adjustable during operation
- Can handle applications up to 140° F
- Wall and base mounting option
- 24 or 120V - 50/60 Hz
- IP65 acid-resistant housing

- Flashing LED indicator during operation
- Manual air bleed pump head facilitates faster priming
- Automatic suction shut-off when de-powered
- Fully adjustable 0-100% range
- Polypropylene housing

CONSTRUCTION:

- Pump Head: Polypropylene
- Suction Tube: PVC
- Seals: Viton

- Diaphragm: Teflon®
- Valves: Viton
- Discharge Tube: Polyethylene

DIMENSIONS:

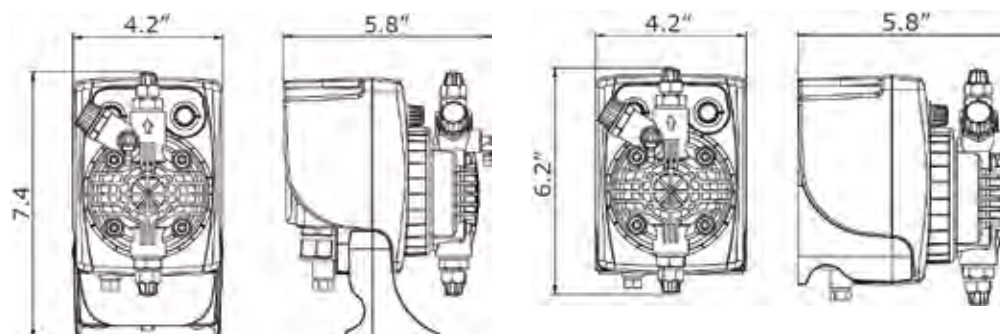

BASE MOUNT

WALL MOUNT



PRICE	PART #	ETATRON #	FLOW	PRESSURE	VOLTAGE
\$274.89	EP107510	PKX0107510EA	.55 oz/minute	72 PSI	120V
\$270.11	EP129010	PKX0129010EA	1.13 oz/minute	87 PSI	120V
\$270.10	EP108510	PKX0108510EA	2.82 oz/minute	72 PSI	120V
\$280.13	EP114601	PKX0114601EA	.55 oz/minute	72 PSI	24V
\$298.16	EP129401	PKX0129401EA	1.13 oz/minute	87 PSI	24V
\$274.95	EP129801	PKX0129801EA	2.82 oz/minute	72 PSI	24V

EXAMPLE OF FOAMING SYSTEM INSTALLATION USING THE PKX PUMP



33" CHEMSTICK WITH BUNG ADAPTER

DILUTION SOLUTIONS

Dilution
SOLUTIONS

The Dilution Solutions CS33 ChemStick is chemical- and acid-resistant, thanks to its polypropylene construction and Viton seals. Keep unwanted particulates out of your chemical system - bung adaptor prevents debris from entering drum after installation, while adjustable depth of ChemStick avoids sucking up debris that has settled at the bottom of the chemical barrel. Hastelloy strainer prevents particulates from being extracted during pumping, and is easy to access for cleaning. Check valve helps prevent any back flow, keeping other liquids out of the barrel.

SPECIFICATIONS & INFORMATION:

- 33" length reaches bottom of most 55-gallon drums
- Adjustable stopper makes it easy to set depth for pipe
- Includes foot spacer and foot valve
- 4 polypropylene hose barbs included: 1/4", 3/8", 1/2", and 3/4"

\$110.09 **CS33**

Your one-stop PUMP warehouse



CAT Pumps
310 Triplex 5-Frame
Plunger Pump

310 triplex plunger pump is designed to deliver smooth, low pulsation flows at different pressures and flow rates. CAT Pumps pressure washing pumps are known as the pumps with nine lives because of their reliability and long life.

4.0 GPM • 950 RPM
2200 PSI

PU00310

Flojet
Air Operated
G57 Series Pump



Flojet's most popular air-operated diaphragm pump. Innovative compact design features a patented shuttle valve that eliminates stalling and provides a long life.

5.0 GPM • 100 PSI

FP7040/ FP7020



Giant Pumps
P316R Pump

The P316R is a triplex plunger positive displacement pump with reciprocating plungers for direct or belt drive applications. This pump features an aluminum crankcase with sight glass and a vented dipstick. It has a forged, ground, and polished crankshaft.

4.0 GPM • 1450 RPM
3350 PSI

PUP316R

General Pump
Car Wash Series
Triplex Plunger Pump



Triplex plunger pump for car washes and preferred in self-service applications. Constructed with a forged brass manifold and solid ceramic plungers.

5.0 GPM • 1250 RPM
1500 PSI

GPCW2040

PROCON® PUMPS

ROTARY VANE PUMPS

PROCON PRODUCTS

- Excellent for tire cleaner, presoak, spot-free RO water, and foam brush
- All pumps use stainless steel rotors
- Feature durable, dependable, three-bearing construction
- Available in either flange or clamp mount
- Buna-N or other elastomer seals available for added chemical resistance
- Special internal materials used to eliminate metal to metal contact allowing for long life and quiet operation



CLAMP STYLE ROTARY VANE PUMPS

PROCON PRODUCTS

PRICE	PART #	PROCON #	MOUNT	PORT SIZE	BODY
\$102.87	PPC01304XLV	101A100R11BB	Clamp	3/8"	Brass
\$84.21	PPC01504A	102A100F11XX	Clamp	3/8"	Brass
\$165.02	PPC01504R	103A100F31RA	Clamp	3/8"	SS
\$94.88	PPCB1304XH	101B100F11BC060	Clamp	3/8"	Brass
\$90.09	PPC01504XLV	102A100R11BB	Clamp	3/8"	Brass
\$170.43	PPC01604XLV	103A100R31BB	Clamp	3/8"	SS
\$150.17	PPCB2507X	104B240F11BA	Clamp	1/2"	Brass
\$166.65	PPCB2507XLV	104B240R11BB	Clamp	1/2"	Brass
\$275.81	PPCB2607X	105B240F31BA	Clamp	1/2"	SS
\$297.30	PPCB2607XLV	105B240R31BB	Clamp	1/2"	SS
\$161.01	PP2507EFX	104E240G12BA200	Clamp	1/2"	Brass



FLANGE STYLE ROTARY VANE PUMPS

PROCON PRODUCTS

PRICE	MODEL	PROCON #	MOUNT	PORT SIZE	BODY
\$100.71	PP1504XLV	102E100R11BB	Flange	3/8"	Brass
\$148.64	PP2507A	104E240F11XX	Flange	1/2"	Brass
\$153.41	PP2504XL	104E165F11BB	Flange	1/2"	Brass
\$153.39	PP2507X	104E240F11BA	Flange	1/2"	Brass
\$264.19	PP2607A	105E240F31XX	Flange	1/2"	SS
\$148.64	PP2508AF	104E265F12XX	Flange	5/8"	Brass
\$594.83	PP3608A	106N480F11XX	Flange	1"	SS



PUMP EXTRAS

PROCON PRODUCTS

PRICE	PART #	DESCRIPTION
\$2.25	PPC1113	Replacement V-Band Clamp
\$38.01	PPC3045	5/8" x 7/16" coupling
\$86.52	PPC32061	5/8" x 5/8" coupling
\$64.87	PPA10481C	Adapter for 56C
\$94.75	PPA3207	Adapter for 3600
\$357.78	PPM012	1/2 HP clamp style motor
\$291.11	PPM013	1/3 HP clamp style motor

ROTARY VANE PUMPS

FLUID-O-TECH PUMPS

- Excellent for tire cleaner, presoak, spot-free RO water, and foam brush
- All pumps use stainless steel rotors
- Feature durable, dependable, three-bearing construction
- Buna-N or other elastomer seals available for added chemical resistance
- Special internal materials used to eliminate metal-to-metal contact allowing for long life and quiet operation
- Available in either flange or clamp mount

TECHNICAL FEATURES AND MANUFACTURING CHARACTERISTICS:

- The rotary vane pumps are available in brass or stainless steel base material, with a stainless steel AISI 303 rotor, and carbon graphite internal parts.
- These inlet and outlet ports are 3/8", 1/2", or 1" NPT/GAS threaded.
- The pumps are designed to be directly mounted to the motor with a stainless steel clamp.
- Maximum operative temperature: 70°C (158°F).

CLAMP STYLE

FLUID-O-TECH PUMPS

PRICE	PART #	DESCRIPTION
\$75.36	FTP300	Brass, 3/8", 1.7 GPM, Clamp Mount, No Relief
\$210.77	FTP811A	Stainless, 1/2", 4.3 GPM, Clamp Mount, Brass Key w/Relief
\$84.62	FTP0301V	Brass, 3/8", 1.7 GPM, Clamp, Viton, w/Relief
\$91.54	FTP0301XV	Brass, 3/8", 1.7 GPM, Clamp, Strainer, Viton, w/Relief
\$117.69	FTP0311V	Stainless, 3/8", 1.7 GPM, Clamp, Viton, w/Relief
\$133.85	FTP0801AV	Brass, 1/2", 4.3 GPM, Clamp, Key, Viton, w/Relief
\$214.62	FTP0811AV	Stainless, 1/2", 4.3 GPM, Clamp, Key, Viton, w/Relief
\$126.15	FTP1000	Brass, 1/2", 5.3 GPM, Clamp Mount, No Relief
\$94.62	FTP401	Brass, 3/8", 2.4 GPM, Clamp Mount, w/Relief



FTPB401



FTP300



FTP0801AV



FTP801F



FTP0311V



FTP811A

FLANGE STYLE

FLUID-O-TECH PUMPS

PRICE	PART #	DESCRIPTION
\$136.15	FTP800F	Brass, 1/2", 4.3 GPM, Flange Mount, No Relief
\$136.15	FTP801F	Brass, 1/2", 4.3 GPM, Flange Mount, w/Relief
\$215.38	FTP810F	Stainless, 1/2", 4.3 GPM, Flange Mount, No Relief
\$91.54	FTP0301FV	Brass, 3/8", 1.7 GPM, Flange, Viton, w/Relief
\$680.00	FTP04040	Stainless, 1", 7.7 GPM, Flange, No Relief



FTP0301V



FTP800F

EXTRAS

FLUID-O-TECH PUMPS

PRICE	PART #	DESCRIPTION
\$25.60	FTP918111	Coupling for 56C to Clamp Mount
\$18.46	FTP928003	Adapter for 56C to Clamp Mount
\$3.24	FTP948001	Replacement V-Band Clamp



FTP0301XV



FTP04040

FLOJET® PUMPS



MODEL G57 DOUBLE DIAPHRAGM AIR DRIVEN TRANSFER PUMP

FLOJET PUMPS

- Constructed of corrosion-resistant materials to handle a variety of chemicals
 - Double diaphragm air driven transfer pump
 - **FLOW:** 7 GPM
 - **PRESSURE:** 100 PSI
 - **MAX TEMP:** 120 °F
 - Self-priming to 15'
 - Patented shuttle valve eliminates stalling
- **AIR INLET/OUTLET:** 1/4" barb
 - **PRODUCT INLET/OUTLET:** 1/2" OR 3/8"



PRICE	PART #	FLOJET #	TYPE
\$104.29	FP7040	G575215D	Santoprene
\$145.98	FP7020	G573215D	Viton
\$205.38	FP57212	G57C212D	Kalrez (1/2")
\$205.63	FP57202	G57C202D	Kalrez (3/8")



REPAIR KITS FOR G57 SERIES

FLOJET PUMPS



PRICE	PART #	FLOJET #	TYPE	QTY/KIT	PIECE #
CHECK VALVE ASSEMBLY KIT					
\$17.18	FPK207400*	20740050A	Santoprene	4	1
\$63.04	FPK207400V	20740020A	Viton	4	1
\$68.98	FPK20740022*	20740022A	Kalrez	4	1
DIAPHRAGM KIT (INCLUDES PISTONS)					
\$25.86	FPK20730	20730000A	Santoprene	2	2
\$47.93	FPK20730V	21000209	Viton	2	2
\$137.41	FPK21000661*	21000661A	Kalrez	2	2
FLANGE HOUSING KIT					
\$47.67	FPK208960	20896000A	-	2	4
HARDWARE KIT (INCLUDES: 14 SCREWS (#10X1.5" HI-LOW), SMALL RETAINER CLIP, LARGE RETAINER CLIPS, EXHAUST PORTS, EXHAUST MUFFLER)					
\$21.84	FPK207931*	20793100A	-	1	5
SHAFT SIDE VALVE KIT					
\$44.10	FPK20751*	20751000A	Santoprene	1	3
\$43.74	FPK20751V*	20751002A	Viton	1	3
PORT KIT					
\$18.96	FPK20381099	20381099	Viton Extreme	-	-
END CAP KIT					
\$41.96	FPK20753	20753000A	-	-	-



FPK20730V

FPK20730



The car wash chemicals and soaps pumped through Flojet air-powered pumps often are corrosive and can shorten the life of a pump and pump components.

To combat this, Flojet pump components are made with tough DuPont elastomers that resist corrosion and help extend their life.



MOUNTING BRACKET

FLOJET PUMPS



- Spring brackets snap together easily - installation is a breeze!
- Ideal for mounting on rack or wall

\$16.16 FPK209821

POLYTUBE & BARB FITTINGS FOR MODEL G57 SERIES

FLOJET PUMPS

\$6.04	FPK06V	3/8" Barb Viton	\$13.88	FPK04PT	1/4" Polytube Fitting
\$4.19	FPK08B	1/2" Barb	\$4.19	FPK06B	3/8" Barb Kit
\$6.20	FPK08B90	90° 1/2" Barb	\$4.19	FPK06B90	90° 3/8" Barb
\$6.47	FPK08MPE	1/2" Male Pipe End	\$6.47	FPK06MPE	3/8" Male Pipe End
\$6.12	FPK08MPE90	90° 1/2" Male Pipe	\$6.12	FPK06MPE90	90° 3/8" Male Pipe
\$24.89	FPK08PT	1/2" Polytube Fitting	\$4.19	FPK06B	3/8" Conversion Kit

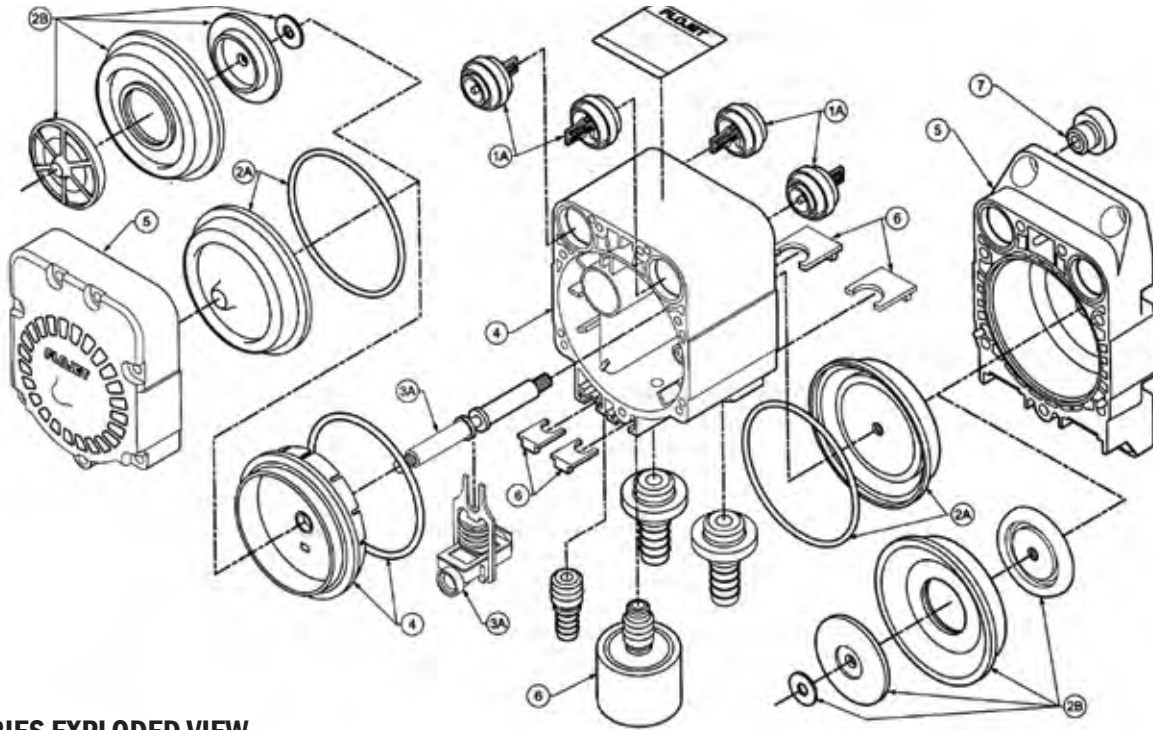

MODEL G57 SERIES EXPLODED VIEW
FLOJET PUMPS

1A	FPK207400	Check Valve Assembly - Santoprene
1B	FPK207400V	Check Valve Assembly - Viton
2A	FPK20730	Diaphragm Kit - Santoprene
2B	FPK20730V	Diaphragm Kit - Viton
3A	FPK20751	Shaft & Slide Valve Assembly - Santoprene

3B	FPK20751V	Shaft & Slide Valve Assembly - Viton
4	FPK208960	Flange & Housing Assembly with O-Ring
5	FPK20753	End Caps
6	FPK207931	Hardware Kit

FLOJET LOW PRESSURE PUMPS



MODEL 5100
FLOJET LOW PRESSURE PUMPS



- **FLOW:** 2.5 GPM
- **MAX PSI:** 80
- **MAX TEMP:** 120 °F
- **LIQUID INLET/OUTLET:** 3/8" barb
- **AIR INLET/OUTLET:** 1/4" barb
- **SEALS:** See Chart
- Compact design with plug-in hose connections
- Pressure relief or bypass plumbing necessary
- Air operated double diaphragm

PRICE	PART #	FLOJET #	TYPE
\$91.61	FP51040	N5100040B	Santoprene®
\$116.50	FP51020	N5100020B	Viton® Elastomer
\$3.97	FPK01510	1/4" Brass Air Inlet Fitting	



DUAL AIR PUMPS
FLOJET LOW PRESSURE PUMPS



- **FLOW:** 10.0 GPM
- **MAX PSI:** 100
- **MAX TEMP:** 120 °F
- **LIQUID INLET/OUTLET:** 1/2" FNPT
- **AIR INLET/OUTLET:** 1/4" barb
- **HOUSING:** Polypropylene
- Compact design with plug-in hose connections
- Pressure relief or bypass plumbing necessary
- Air operated double diaphragm

PRICE	PART #	FLOJET #	TYPE
\$248.31	FP257501	G257501A	Santoprene
\$306.63	FP257301	G257301A	Viton



FLOJET ELECTRIC DIAPHRAGM PUMPS



FP04300042

FLOJET ELECTRIC DIAPHRAGM PUMPS



- **FLOW:** 3.4 GPM
- **VOLTAGE:** 115V
- **DIAPHRAGM:** Santoprene
- **BODY:** Polypropylene
- **MAX PSI:** 45
- **PORTS:** 1/2" barb
- **CHECK VALVE:** EPDM

\$159.20 FP04300042

Flojet #04300042A

FP04300043

FLOJET ELECTRIC DIAPHRAGM PUMPS



- **FLOW:** 5.0 GPM
- **VOLTAGE:** 115V
- **DIAPHRAGM:** Santoprene
- **BODY:** Polypropylene
- **MAX PSI:** 45
- **PORTS:** 3/4" barb
- **CHECK VALVE:** EPDM

\$162.53 FP04300043

Flojet #04300043A

FP04300043 & FP04300042 KITS

FLOJET ELECTRIC DIAPHRAGM PUMPS

PRICE	PART #	FLOJET #	DESCRIPTION
\$70.74	FPK20404018	20404018	Upper Housing Kit
\$30.57	FPK20407030	20407030	Check Valve Kit
\$19.57	FPK20403040	20403040	Diaphragm Kit
\$53.26	FPK20115210	20115210	Brush Endbell Kit
\$38.78	FPK20400002	20400002	CAM KIT FOR FP04300042
\$50.65	FPK20400003	20400003	CAM KIT FOR FP04300043

FP04100143

FLOJET ELECTRIC DIAPHRAGM PUMPS



- **FLOW:** 5.0 GPM
- **PORTS:** 3/4"
- **BODY:** Polypropylene
- **MAX PSI:** 25
- **DIAPHRAGM:** Santoprene
- **VOLTAGE:** 12VC Demand
- **CHECK VALVE:** EPDM

\$152.43 FP04100143 Flojet #04100143

FP04100143 KITS

FLOJET ELECTRIC DIAPHRAGM PUMPS

PRICE	PART #	FLOJET #	DESCRIPTION
\$44.53	FPK20404011	20404011	Upper Housing Kit
\$30.57	FPK20407030	20407030	Check Valve Kit
\$50.65	FPK20400003	20400003	Cam Bearing Kit



FP04300504

FLOJET ELECTRIC DIAPHRAGM PUMPS

- **FLOW:** 5.0 GPM
- **VOLTAGE:** 12V
- **DIAPHRAGM:** Santoprene
- **BODY:** Polypropylene
- **MAX PSI:** 45
- **PORTS:** 3/4" barb
- **CHECK VALVE:** Viton

\$192.21 FP04300504

Flojet #04300504A



"QUAD" DEMAND PUMPS

FLOJET ELECTRIC DIAPHRAGM PUMPS

- **FLOW:** 3.5 GPM
- **VOLTAGE:** 12V
- **DIAPHRAGM:** Santoprene
- **BODY:** Polypropylene
- **MAX PSI:** 45
- **PORTS:** 1/2"
- **CHECK VALVE:** Viton

\$192.21 FP04300500

Flojet #04300500A



FP04300504 KITS

FLOJET ELECTRIC DIAPHRAGM PUMPS

PRICE	PART #	FLOJET #	DESCRIPTION
\$80.34	FPK20404017	20404017	Upper Housing Kit
\$40.03	FPK20407020	20407020	Check Valve Kit
\$19.57	FPK20403040	20403040	Diaphragm Kit
\$50.65	FPK20400003	20400003	CAM BEARING KIT FOR FP04300504
\$38.78	FPK20400002	20400002	CAM BEARING KIT FOR FP04300500



Established in 1975 as a manufacturer of special application pumps with an initial focus on the emerging cleaning machine market, XYLEM FLOJET has blossomed into a leading global supplier of small pumps, motors and dispensing pumps for a variety of industries.

FLOJET ELECTRIC DIAPHRAGM PUMPS



FP02130032

FLOJET ELECTRIC DIAPHRAGM PUMPS



- **FLOW:** 2.0 GPM
- **MAX PSI:** 95
- **VOLTAGE:** 115V
- **BODY:** Nylon
- **DIAPHRAGM:** EPDM
- **CHECK VALVE:** EPDM

\$214.63	FP02130032
Flojet #02130032A	

FP02130232

FLOJET ELECTRIC DIAPHRAGM PUMPS



- **FLOW:** 1.8 GPM
- **MAX PSI:** 95
- **VOLTAGE:** 230V
- **BODY:** Nylon
- **DIAPHRAGM:** EPDM
- **CHECK VALVE:** EPDM

\$224.85	FP02130232
Flojet #02130232A	

FP02130032 & FP02130232 KITS

FLOJET ELECTRIC DIAPHRAGM PUMPS

PRICE	PART #	DESCRIPTION	FLOJET #
\$11.70	FPP11028101	Baseplate Assembly, Plastic, Includes grommets and screws	11028101
\$62.00	FPK20316003A	Upper Housing/Switch Assembly	20316003A



DUPLEX SERIES PUMP

FLOJET ELECTRIC DIAPHRAGM PUMPS



- **FLOW:** 1.6 GPM
- **MAX PRESSURE:** 60 PSI
- **VOLTAGE:** 115V DEMAND W/ Bypass

\$135.69	FP1631H5011	Flojet# D1631H5011A
-----------------	--------------------	---------------------

DUPLEX SERIES KITS

PRICE	PART #	DESCRIPTION	FLOJET #
\$44.53	FPP02090100	Pressure Switch	02090100
\$17.11	FPK20914003	EPDM Check Valve Kit	20914003A
\$62.00	FPK21022042	Cam Bearing/Diaphragm Kit	21022042A
\$139.73	FPM02029000	Motor Assembly - 115V	02029000A
\$53.26	FPK20115210	End Bell Brush Kit	20115210



TRIPLEX SERIES PUMP

FLOJET ELECTRIC DIAPHRAGM PUMPS



- **FLOW:** 2.0 GPM
- **INLET:** 3/8" NPTF
- **MAX PSI:** 60 PSI
- **OUTLET:** 3/8" NPTF
- **LIQUID TEMP:** 40° F - 140° F

\$132.03	FP03501503	Flojet# 03501503A
-----------------	-------------------	-------------------

TRIPLEX SERIES KITS

PRICE	PART #	DESCRIPTION	FLOJET #
\$48.90	FPK02091060	Pressure Switch	02091060
\$39.30	FPK20407033	Check Valve Kit	20407033

VARIOUS PUMP MODELS & KITS

(ALL PUMP MODELS & KITS AVAILABLE!)
FLOJET ELECTRIC DIAPHRAGM PUMPS



- Great choice for tire cleaner, presoak, carpet cleaning and extraction applications. All pumps can be run dry without damage and have superior self-priming capabilities. Rated to 160° F.

AVAILABLE IN TWO STYLES:

- **BYPASS:** Pump continues to run and internally bypass if discharge is partially or fully closed.
- **DEMAND:** Pressure switch automatically starts and stops pumps at specific pressure settings

PRICE	PART #	FLOJET #	GPM	VOLTS	PSI	CONTROL	CONNECTION
\$166.90	FP02100032	02100032A	1.6	115	60	DEMAND	Hard wire
\$192.81	FP02100022 With Viton seal	02100022A	1.6	115	60	DEMAND	Hard wire
\$313.41	FP304010110 With Viton seal	I304010110	3.5	115	45	DEMAND	6' Cord
\$217.95	FP02100689	02100689A	2.0	230	55	BYPASS	Hard wire
\$56.30	FP508224	ET508224A	0.4	115	55	ON/OFF	Hard wire
\$188.21	FP04300545	04300545A	3.5	115	45	DEMAND	6' Cord
\$201.69	FP3635E7011	D3635E7011A	2.0	115	100	DEMAND	Hard wire
\$182.44	FP3835H1411	D3835H1411A	2.0	115	70	BYPASS	6' Cord

PENTAIR STA-RITE BOOSTER & CENTRIFUGAL PUMPS



BOOSTER PUMPS PENTAIR STA-RITE PUMPS

- The HP/HPS Booster Pumps are the most durable booster pump available. The patented SignaSeal™ floating impeller design minimizes thrust loads allowing for continuous operation without damage to motor bearings, mechanical seal or pump hydraulic components.
- MAX. INLET PRESSURE:** 80 PSI • **MAX. SUCTION LIFT:** 15 ft.
- MAX. WORKING PRESSURE:** 315 PSI • **MAX. TEMP.:** 140° F

PRICE	PART#	MATERIAL	MOTOR	GPM	PSI	PORT SIZE DISCHARGE/SUCTION
\$1,080.35	HP10D	Cast Iron	3/4HP - 1 Phase	10 GPM	100 PSI	3/4" / 3/4"
\$1,221.77	HP10E		1 HP - 1 Phase	10 GPM	135 PSI	3/4" / 3/4"
\$1,311.72	HP10E3		1 HP - 3 Phase	10 GPM	135 PSI	3/4" - 3/4"
\$1,578.80	HP10G		2 HP - 1 Phase	10 GPM	195 PSI	3/4" / 3/4"
\$1,323.29	HP10G3		2 HP - 3 Phase	10 GPM	195 PSI	3/4" / 3/4"
\$1,455.91	HP20G		2 HP - 1 Phase	15 GPM	145 PSI	1" / 1"
\$1,246.80	HP20G3		2 HP - 3 Phase	15 GPM	145 PSI	1" / 1"
\$2,210.73	HP20H		3 HP - 1 Phase	20 GPM	195 PSI	1" / 1"
\$2,005.34	HP20H3		3 HP - 3 Phase	20 GPM	195 PSI	1" / 1"
\$2,151.09	HP30H		3 HP - 1 Phase	30 GPM	125 PIS	1 1/4" / 1 1/4"
\$2,071.72	HP30H3	3 HP - 3 Phase	30 GPM	125 PSI	1 1/4" / 1 1/4"	
\$1,231.87	HP7E	Stainless Steel	1 HP - 1 Phase	6 GPM	195 PSI	3/4" / 3/4"
\$1,712.94	HPS10G3		2 HP - 3 Phase	10 GPM	195 PSI	3/4" / 3/4"
\$1,644.32	HPS20G3		2 HP - 3 Phase	15 GPM	145 PSI	1" / 1"
\$2,470.48	HPS20H		3 HP - 1 Phase	20 GPM	315 PSI	1" / 1"
\$2,764.21	HPS20H3		3 HP - 3 Phase	20 GPM	155 PSI	1" / 1"
\$2,521.95	HPS30H		3 HP - 1 Phase	30 GPM	125 PSI	1 1/4" / 1 1/4"
\$2,647.01	HPS30H3		3 HP - 3 Phase	30 GPM	125 PSI	1 1/4" / 1 1/4"
\$1,564.17	HPS7E		1 HP - 1 Phase	6 GPM	195 PSI	3/4" / 3/4"
\$1,795.14	HPS10F		1 1/2 HP - 1 Phase	10 GPM	175 PSI	3/4" / 3/4"
\$1,816.30	HPS10F3		1 1/2 HP - 3 Phase	10 GPM	175 PSI	3/4" / 3/4"
\$1,531.54	HPS10E0	1 HP - 1 Phase	10 GPM	134 PSI	3/4" / 3/4"	



J & JB SERIES HIGH HEAD CENTRIFUGAL PUMP PENTAIR STA-RITE PUMPS

- Drain port provides for easy winterizing
- Delivers up to 140' of head, with flow rates up to 90 GPM
- Replaceable wear ring and simple back pull-out design provide easy serviceability
- Silicon bronze impellers and shaft seals (in JB series) allow use with water up to 225° F

PRICE	PART #	MOTOR	DESCRIPTION
\$1,418.03	JHG3-52HMS7	2 HP - 3 Phase	Vertical Discharge, seal flush line, Shaft Seal - Viton w/silicon carbide face
\$930.76	JHG3-52HMS10	2 HP - 3 Phase	Horizontal discharge, seal flush line, Standard Shaft Seal w/carbon ceramic faces

PENTAIR STA-RITE JET PUMPS



PLASTIC



CAST IRON



STAINLESS STEEL



JET PUMPS

PENTAIR STA-RITE PUMPS

- Pentair Sta-Rite Jet pumps are an ideal choice for water booster systems in car washes, farms, home, etc. Designed for use in shallow well pumping systems (to 25' lift) or in foam brush, presoak and tire cleaner applications. All pumps come standard with adjustable pressure switches with shut-off pressures to 70 PSI (no pressure switch on CJ models). Available with cast iron, stainless or plastic bodies.
- MAX. TEMPERATURE LIMITS:** 122° F (50° C)
- MAX. INLET PRESSURE:** 50 PSI
- AVG. PRIMING TIME AT 20 FEET:** CJ90E = 5.3 min. CJ90F = 4.2 min.

ALL PENTAIR BRANDS ARE TRADEMARKS OF PENTAIR

PRICE	PART #	MAX FLOW	SHUT-OFF PSI	BODY	1-PHASE MOTORS	PORT SIZE DISCHARGE/SUCTION
\$605.77	HNC	15.0 GPM	70	Cast Iron	1/2 HP 115/230 V	1" / 1/4"
\$769.62	HND	21.4 GPM	64	Cast Iron	3/4 HP 115/230 V	1" / 1/4"
\$853.85	HNE	28.5 GPM	67	Cast Iron	1 HP 115/230 V	1" / 1/4"
\$560.88	PNC	8.6 GPM	77	Plastic	1/2 HP 115/230 V	1" / 1/4"
\$576.73	PND	12.8 GPM	77	Plastic	3/4 HP 115/230 V	1" / 1/4"
\$628.20	PNE	18.0 GPM	67	Plastic	1 HP 115/230 V	1" / 1/4"
\$618.10	PWP-MS1	10.3 GPM	-	Plastic	1/2 HP 115/230 V	1" / 1/4"
\$843.88	CJ90F	14.1 GPM	80	Stainless	1 1/2 HP 115/230 V	1" / 1/4"
\$853.18	CJ90E	14.1 GPM	63	Stainless	1 HP 115/230 V	1" / 1/4"

PUMPS



PENTAIR STA-RITE PUMPS



RECLAIM PUMPS

PENTAIR STA-RITE PUMPS

- Drain port provided for easy winterizing
- Normal wear parts are easily accessible for service and replacement without disturbing piping or mounting
- Heavy-duty motors are designed for continuous operation

PRICE	PART #	DESCRIPTION
\$887.47	DHE350	Reclaim Pump 1HP/3PH - 1½" Port
\$1,376.18	DHG352	Reclaim Pump 2HP/3PH - 2" Port
\$2,065.23	DHH316	Reclaim Pump 3HP/3PH - 2" Port
\$2,139.06	DHJ3	Reclaim Pump 230/460 3PH 5HP - 2" Port
\$312.07	PKG51	6" Trap with Basket - 2" FPT - 1 & 2 HP - 1½" Port
\$216.85	PKG53	2" Inlet Flange with Flapper - 1 & 2 HP - 2" Port
\$243.20	PKG73	3" Inlet Flange with Flapper - 3 & 5 HP - 3" Port
\$872.10	PKG98	8" Trap with Basket - 3" FPT - 3 & 5 HP - 3" Port



SUBMERSIBLE PUMPS

PENTAIR STA-RITE PUMPS

- Reduced amp draw
- Cooler and quieter operation
- **IMPELLERS** - Precision molded for perfect balance... ultra smooth for the highest performance and efficiency. Allows for .080" solids.
- **SHAFT** - Positive drive, hexagonal 7/16" - 300-grade stainless steel shaft offers generous impeller drive surfaces.
- **SHAFT BEARING** - Exclusive self-lubricating Nylatron® bearing resists wear surface from sand and abrasives.
- **SHELL** - Heavy-walled, corrosion-resistant 300-grade stainless steel.

PRICE	PART #	GPM	PSI	VOLTAGE	PORT	PRICE	PART #	GPM	PSI	VOLTAGE	PORT
\$518.94	20DM5121	14	50	1/2HP 115V	1¼"	\$548.65	30DM5121	30	25	1/2HP 115V	1½"
\$518.94	20DM5221	14	50	1/2HP 230V	1¼"	\$548.65	30DM5221	30	25	1/2HP 230V	1½"

ALL PENTAIR BRANDS ARE TRADEMARKS OF PENTAIR

BOOSTER PUMPS



MULTI-STAGE BOOSTER PUMPS

FLINT & WALLING PUMPS



PRICE	PART #	DESCRIPTION
\$806.40	FWPB1014S101	Multi-stage booster pump with a stainless steel shell Cast iron suction & discharge 14 stage, 1HP, 1PH, 115/230v, 185PSI
\$654.96	FWPB1016A151	Multi-stage booster pump with a stainless steel shell 16 stage, 1½HP, 1PH, 115/230v, 211PSI
\$1,038.33	FWPB1914A203	Multi-stage booster pump with a cast iron housing 2HP, 3PH 208-230/460v, 190 PSI

MULTI-STAGE BOOSTER PUMP

DAYTON PUMPS



- Includes o-ring casing seal: High-pressure sealing with simple disassembly for easy maintenance and repair.
- Highly-resistant diffusers: Glass-filled with fixed impeller design
- 300 stainless steel rabbit lock bowls, no gaskets required
- 13-stage
- Continuous duty
- Dimensions: 29½" L x 6¾" W x 8¾" H
- Ball-bearing
- 56J Frame

\$615.61	45MW74	1 Phase, 115/230 Voltage
\$899.04	45MW90	3 Phase, 208-230/460 Voltage

GOULDS PUMPS



GB SERIES - MULTI-STAGE BOOSTER PUMPS GOULDS PUMPS

- Multi-stage design provides steady, quiet, vibration free operation
- Standard cast iron for general service or stainless steel for filtration applications
- Reliable high-pressure sealing with easy disassembly for maintenance or repair
- Motors are designed for continuous operation
- Impellers and diffusers are glass filled composite material with fixed impeller design
- High resistance to corrosion and abrasion
- Bowls: 300 stainless steel rabbit lock for positive alignment with no gaskets required
- Maximum suction inlet pressure: 75 PSI

GB SERIES GOULDS PUMPS

PRICE	PART #	MOTOR	MATERIAL	FLOW
\$1,001.84	GL7GBC1014R0	1HP - 1 Phase	Cast Iron/Buna-N Seals	7 GPM
\$1,266.23	GL7GBS1014R4	1HP - 1 Phase	Stainless Steel/Viton Seals	7 GPM
\$1,491.12	GL7GBS1517R4	1½HP - 3 Phase	Stainless Steel/ Viton Seals	7 GPM
\$1,469.30	GL10GBC1514Q0	1½HP - 1 Phase	Cast Iron/Buna-N Seals	10 GPM
\$1,759.10	GL10GBC2017S0	2HP - 3 Phase	Cast Iron/Buna-N Seals	10 GPM
\$1,329.04	GL10GBS1514Q4	1½HP - 1 Phase	Stainless Steel/Viton Seals	10 GPM
\$1,460.22	GL10GBS2014S4	2HP - 1 Phase	Stainless Steel/Viton Seals	10 GPM
\$1,536.70	GL10GBS2017S4	2HP - 3 Phase	Stainless Steel/Viton Seals	10 GPM
\$1,141.13	GL18GBC2014N0	2HP - 1 Phase	Cast Iron/Buna-N Seals	18 GPM
\$1,250.03	GL18GBC2017N0	2HP - 3 Phase	Cast Iron/Buna-N Seals	18 GPM
\$1,492.64	GL18GBC3014Q0	3HP - 1 Phase	Cast Iron/Buna-N Seals	18 GPM
\$1,678.52	GL18GBC3017Q0	3HP - 3 Phase	Cast Iron/Buna-N Seals	18 GPM
\$1,405.01	GL18GBS2014N4	2HP - 1 Phase	Stainless Steel/Viton Seals	18 GPM
\$1,755.00	GL18GBS3014Q4	3HP - 1 Phase	Stainless Steel/Viton Seals	18 GPM

NPE SERIES - 1" x 1¼" GOULDS PUMPS

PRICE	PART #	MOTOR	GPM	PSI	MAX GRAVITY
\$858.51	GL1ST1C4E4	½HP - 1 Phase	12	30	1.0
\$858.51	GL1ST1C4F4	½HP - 1 Phase	28	15	1.0
\$848.88	GL1ST1D1D2	¾HP - 1 Phase	17	36	1.0
\$825.08	GL1ST1D1D4	1 Phase Open Drip Proof Motor	Call for Info	Call for Info	1.0
\$1,402.80	GL1ST1F1B4	1½HP - 1 Phase	Call for Info	Call for Info	Call for Info
\$1,074.78	GL1ST1F4C4	1½HP - 1 Phase	20	45	1.0
\$943.60	GL1ST1E4D4	1HP - 1 Phase	30	30	1.0
\$1,191.78	GL1ST1G4A4	2HP - 1 Phase	30	56	1.0
\$1,191.78	GL1ST1G4B4	2HP - 1 Phase	50	30	1.0
\$1,601.03	GL1ST1H9B4	3HP - 3 Phase	50	30	1.4
\$1,118.34	GL1ST1G9B4*	2HP - 3 Phase	50	30	Call for Info

NPE SERIES - 2 ST - 1½" x 1¼" GOULDS PUMPS

PRICE	PART #	MOTOR	GPM	PSI	MAX GRAVITY	INLET x OUT
\$899.03	GL2ST1E1J4*	1HP - 1 Phase Open Drip Proof Motor	40	25	Call for Info	1½" x 1¼"
\$1,602.55	GL2ST4H9B4*	3HP - 3 Phase	45	40	Call for Info	
\$1,602.55	GL2ST1H4D4*	3HP - 1 Phase	50	45	1.0	
\$1,034.77	GL2ST1F1H4*	1½HP - 1 Phase	60	25	Call for Info	
\$1,093.01	GL2ST1F4H4*	1½HP - 1 Phase	70	20	1.0	
\$1,208.49	GL2ST1G4G4*	2HP - 1 Phase	70	30	1.0	
\$1,602.55	GL2ST1H9G4*	3HP - 3 Phase	70	30	1.4	
\$1,607.10	GL2ST1J1C4*	5HP - 1 Phase	70	52	1.0	
\$1,602.55	GL2ST1H9D4*	3HP - 3 Phase	80	40	Call for Info	

NPE SERIES - 3 ST - 1½" X 2" GOULDS PUMPS

PRICE	PART #	MOTOR	GPM	PSI	MAX GRAVITY	INLET x OUT
\$2,103.97	GL3ST1J9D4*	5HP - 3 Phase	125	25	1.5	2" x 1½"
\$1,613.69	GL3ST1H9E4*	3HP - 3 Phase	110	25	Call for Info	

* INDICATES THIS PUMP IS HIGH EFFICIENCY!



NPE SERIES - CENTRIFUGAL PUMPS GOULDS PUMPS

- Complete AISI 316L stainless steel liquid handling components and mounting bracket for corrosion resistance, appearance, and improved strength.
- Enclosed impeller with unique floating seal ring design maintains efficiency for the life of the pump without adjustments.
- Stainless steel construction with NPT threads, center line connections, accessible vent, prime and drain connections with SS plugs.
- Rugged ball bearing design for continuous reliable duty under all operating conditions.

NPE SERIES - SEAL KIT GOULDS PUMPS

\$120.78 GLKNPE



BERKELEY PUMPS

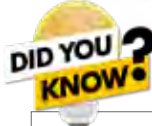

ALSO AVAILABLE IN 3 PHASE

High-head performance and quiet operation join corrosion-resistant dependability with Berkeley SSCX Series centrifugal pumps.

SSCX SERIES CENTRIFUGAL PUMPS

BERKELEY PUMPS

- **STAINLESS-STEEL HOUSING AND SHAFT** – Maximum corrosion resistance in chemical as well as water applications; smooth flow path assures quiet operation.
- **HIGH-TEMPERATURE RATING** – The SSCX Series centrifugal pump (with 304 SS Impeller) is designed for temperatures to 250 °F, making it an ideal choice for a wide range of pump applications and varying temperature conditions. The Noryl® impeller is rated to a maximum operating temperature of 185 °F.
- **MECHANICAL SHAFT SEALS** – Choice of seal options to meet your application needs. All are precision lapped and highly polished for long life and reliability.
- **IMPELLER OPTIONS** – 304 Stainless Steel or precision-molded Noryl® feature ultra-smooth flow ports to maximize performance and efficiency.
- **DRAIN/VENT PORTS** – Priming and draining is easier, faster.

PRICE	KR PART #	DESCRIPTION
\$873.31	B82411	Berkeley Centrifugal Pumps 3/4 HP Single Phase
\$1,056.76	B82493	Berkeley Centrifugal Pumps 1 HP Single Phase 50 PSI
\$1,216.55	B82421	Berkeley Centrifugal Pumps 1½ HP Single Phase



ARO DIAPHRAGM PUMPS



GRIME FIGHTER PUMP

ARO DIAPHRAGM PUMPS

- **AIR INLET:** 1/4" NPTF
- **FLUID INLET:** 1/2" NPTF
- **FLUID OUTLET:** 1/2" NPTF
- **MAX PRESSURE:** 100 PSI
- **WEIGHT:** 7.2 LBS
- **RATIO:** 1:1
- **MAX FLOW:** 7 GPM
- **MATERIALS:** Virgin PTFE, polypropylene & Santoprene

\$503.43 APJGF



ARO J-STYLE PUMP

ARO DIAPHRAGM PUMPS

- **AIR INLET:** 1/4" NPTF
- **FLUID INLET:** 1/2" NPTF
- **FLUID OUTLET:** 1/2" NPTF
- **MAX PRESSURE:** 100 PSI
- **MAX FLOW:** 13 GPM
- **MATERIALS:** Polypropylene

PRICE	PART #	MFG PART #
\$867.60	APJ388	66605J-388
\$889.00	APJ3EB	66605J-3EB
\$1,047.60	APJ344	66605J-344



1/4" COMPACT DIAPHRAGM PUMP

ARO DIAPHRAGM PUMPS

- Versatile OEM fluid dosing, from cleaners to chemicals to paint
- **INLET:** 1/4"
- **OUTLET:** 1/4"
- **MAX PRESSURE:** 125 PSI
- **MAX FLOW:** 5.3 GPM
- **MAX TEMP:** 175° F
- **MATERIALS:** Varies

PRICE	PART #	MATERIAL
\$393.30	APM01	Santoprene
\$527.72	APM01T	Teflon



1/2" DIAPHRAGM PUMP

ARO DIAPHRAGM PUMPS

- Ease of service through modular design
- Simul-Shift™ valve provides ultra-positive, reliable shift signal
- ARO's patented "Unbalanced" air valve ensures no-stall operation
- Center, end, and dual inlet/outlet manifold configurations for your application needs
- Bolted construction for leak-free fluid handling
- **INLET:** 1/2" • **OUTLET:** 1/2"
- **MAX PRESSURE:** 100 PSI • **MAX FLOW:** 13 GPM
- **MAX TEMP:** 150° F • **MATERIALS:** Varies

PRICE	PART #	DIAPHRAGM MATERIAL
\$854.10	AP388	Urethane (for Soap)
\$823.50	AP3EB	Santoprene (for Soap)
\$1,033.20	AP344	Teflon (for tire/engine cleaner)

1/2" DIAPHRAGM PUMP KITS

ARO DIAPHRAGM PUMPS

PRICE	PART #	GPM
\$116.67	APK141	Air Service Kit
\$170.00	APK88	Diaphragm Kit 388
\$138.88	APKEB	Diaphragm Kit 3EB
\$564.45	APK33	Diaphragm Kit 333

AR NORTH AMERICA PUMPS

RTX30 SERIES TRIPLEX PLUNGER PUMP

AR NORTH AMERICA PUMPS



- **MAX FLOW:** Varies by model - see below
- **MAX SPEED:** 1450 RPM
- **INLET:** 1" Female
- **BODY:** Die cast aluminum alloy
- **STROKE:** Varies by model - see below
- **MAX PRESSURE:** Varies by model - see below
- **MAX TEMP:** 140 °F
- **OUTLET:** 1/2" Female
- **BORE:** Varies by model - see below

PRICE	PART #	MODEL	MAX FLOW	MAX PRESSURE	BORE	STROKE
\$2,020.75	ARTX30	RTX30	7.9 GPM	4350 PSI	20 mm	23 mm
\$2,020.75	ARTX50	RTX50	13.2 GPM	2900 PSI	25 mm	23 mm
\$2,020.75	ARTX60	RTX60	15.8 GPM	4350 PSI	25 mm	28 mm
\$1,707.68	ARTX70	RTX70	18.5 GPM	1450 PSI	30 mm	23 mm
\$1,707.68	ARTX85	RTX85	22.5 GPM	2200 PSI	30 mm	28 mm
\$1,707.68	ARTX100	RTX100	26.4 GPM	1800 PSI	36 mm	22 mm



RKA45G40HN PUMP

AR NORTH AMERICA PUMPS

- **MAX FLOW:** 4.5 GPM
- **MAX PRESSURE:** 4000 PSI
- **MAX SPEED:** 1750 RPM
- **MAX TEMP:** 140 °F
- **INLET:** 1/2" Female
- **OUTLET:** 3/8" Female
- **BORE:** 30 mm
- **STROKE:** 28 mm

\$397.03 ARKA45G40HN



XTA3G22N PUMP

AR NORTH AMERICA PUMPS

- **MAX FLOW:** 3.0 GPM
- **MAX PRESSURE:** 2200 PSI
- **MAX SPEED:** 1750 RPM
- **MAX TEMP:** 140 °F
- **INLET:** 1/2" Female
- **OUTLET:** 3/8" Female
- **BORE:** 18 mm
- **STROKE:** 9.6 mm

\$324.39 ARXTA3G22N

AR NORTH AMERICA PUMPS FOR PRESSURE CLEANING

PRESSURE CLEANING PUMPS

AR NORTH AMERICA



ARXMV25G26DF25



ARXWAM8G35N



ARRCA35G25N

\$421.23	ARKA35G40HEF17	3.5 GPM	4000 PSI	1750 RPM	1 1/8" Shaft
\$397.03	ARKA35G40HN	3.5 GPM	4000 PSI	1750 RPM	24 mm Shaft
\$397.03	ARKA4G40HN	4 GPM	4000 PSI	1750 RPM	24 mm Shaft
\$115.23	ARMV25G24D	2.5 GPM	2400 PSI	3400 RPM	3/4" Shaft
\$115.23	ARMW22G24EZ	2.2 GPM	2400 PSI	3400 RPM	7/8" Shaft
\$250.32	ARRCA35G25N	3.5 GPM	2500 PSI	1750 RPM	24 mm Shaft
\$397.03	ARRK1528HN	3.96 GPM	4000 PSI	1450 RPM	24 mm Shaft
\$385.41	ARRKV35G40HD24	3.5 GPM	4000 PSI	3400 RPM	1" Hollow
\$364.34	ARRKV4G30AD	4 GPM	3000 PSI	3400 RPM	1" Hollow
\$426.07	ARRKV4G40HD	4 GPM	4000 PSI	3400 RPM	1" Hollow
\$242.10	ARSJV25G27D-F7	2.5 GPM	2700 PSI	3400 RPM	3/4" Hollow
\$789.21	ARSXWA55G50	5.5 GPM	5000 PSI	1750 RPM	24 mm Shaft
\$295.35	ARXMV25G26DF25	2.5 GPM	2600 PSI	3400 RPM	3/4" Shaft
\$314.72	ARXTA2G15EBAF8	2.11 GPM	1800 PSI	1750 RPM	3/4" Shaft
\$634.28	ARXWAM8G35N	8 GPM	3500PSI	1750 RPM	24 mm Shaft
\$14.22	AR1836				1/2" Rail Kit
\$18.76	AR1836H				1 1/8" Rail Kit

SANDPIPER® STANDARD DUTY BALL NON-METALLIC PUMPS

SANDPIPERPUMPS

- Standard duty non-metallic pumps are ideally suited for highly corrosive fluids, intermittent/on-demand, portable, low abrasive fluids, and suspended solids. Standard duty non-metallic pumps are constructed in polypropylene, PVDF, conductive acetal and conductive polypropylene with TPE (thermal plastic elastomers) and PTFE options in diaphragms and check valves.



1/4" PB SERIES

SANDPIPER STANDARD DUTY BALL NON-METALLIC PUMPS



PRICE	PUMP #	BODY	DIAPHRAGM	PORTS	MAX. FLOW
\$427.09	SP04PS	Poly	Santoprene	1/4"	5 GPM @ 6 CFM
\$519.68	SP04PT	Poly	Teflon	1/4"	5 GPM @ 6 CFM

1/4" PB SERIES KIT

SANDPIPER STANDARD DUTY BALL NON-METALLIC PUMP



PRICE	KIT #	PUMP #	DESCRIPTION
\$244.91	SPK476129	SP04PS	1/4" Air End Kit



1/2" S05 SERIES

SANDPIPER STANDARD DUTY BALL NON-METALLIC PUMPS



- The only pump with the anti-stall guarantee

PRICE	PUMP#	BODY	DIAPHRAGM	PORTS	MAX. FLOW
\$918.40	SP08PPS	Poly	Santoprene	1/2"	14 GPM @ 16 CFM
\$1,116.27	SP08PT	Poly	Teflon	1/2"	14 GPM @ 16 CFM
\$918.40	SP08PU	Poly	Urethane	1/2"	14 GPM @ 16 CFM

1/2" S05 SERIES KITS

SANDPIPER STANDARD DUTY BALL NON-METALLIC PUMP



PRICE	KIT#	PUMP #	DESCRIPTION
\$399.47	SPK08A	SP08PPS	Air End Kit
\$109.21	SPK08DS	SP08PPS	Santoprene Diaphragm Kit
\$434.56	SPK08DT	SP08PT	Teflon Diaphragm Kit
\$156.05	SPK08DU	SP08PU	Urethane Diaphragm Kit



3/4" S07 SERIES

SANDPIPER STANDARD DUTY BALL NON-METALLIC PUMPS



PRICE	PUMP #	BODY	DIAPHRAGM	PORTS	MAX. FLOW
\$1,082.67	SP12PS	Poly	Santoprene	3/4"	23 GPM @ 20 CFM
\$1,127.47	SP12PT	Poly	Teflon	3/4"	23 GPM @ 20 CFM

VERSAMATIC® PUMPS



3/8" DIAPHRAGM PUMP

VERSAMATIC PUMPS

- Can be mounted in any position (vertical, horizontal, upside down)
- Inlet/discharge manifolds can be rotated to meet your mounting needs
- Available in polypropylene or Kynar wetted sections and fitted with Santoprene or Teflon for superior chemical resistance

PRICE	PART #	BODY	DIAPHRAGM	PORT SIZE	MAX FLOW
\$459.89	VME8PS	Poly	Santoprene	3/8"	6.8 GPM
\$527.81	VME8PT	Poly	Teflon	3/8"	6.8 GPM
\$1,200.50	VME8KT	Kynar	Teflon	3/8"	6.8 GPM



1/2" DIAPHRAGM PUMP

VERSAMATIC PUMPS

- Drop in replacement for ARO 1/2" (same center line & foot print)
- Multiple porting options
- Patented non-stalling, anti-icing, lubrication free air valve system
- Available in Kynar/Teflon for superior chemical resistance

PRICE	PART #	BODY	DIAPHRAGM	PORT SIZE	MAX FLOW
\$689.51	VME5PS	Poly	Santoprene	1/2"	11 GPM
\$834.97	VME5PT	Poly	Teflon	1/2"	10 GPM
\$1,200.50	VME8KT	Poly	Bonded PTFE	3/8"	6.8 GPM

DIAPHRAGM PUMP KITS

VERSAMATIC PUMPS

PRICE	PART #	DESCRIPTION
\$78.40	VMKE8DS	Santoprene Wet End Kit 3/8" (for VME8PS)
\$294.20	VMKE8DT	Teflon Wet End Kit 3/8" (for VME8PT & VME8KT)
\$115.00	VMKE5DS	Santoprene Wet End Kit 1/2" (for VME5PS)
\$462.56	VMKE5DT	Teflon Diaphragm Kit
\$184.44	VMKE1DS	Santoprene Wet End Kit 1" (for VME1PS)

PRICE	PART #	DESCRIPTION
\$634.22	VMKE1DT	Teflon Wet End Kit 1" (for VME1PS)
\$107.52	VMKE8A	Air End Kit 3/8" (for all E8 models)
\$223.25	VMKE5A	Air End Kit 1/2" (for all E5 models)
\$211.30	VMKE1A	Air End Kit 1" (for all E1 models)



MANIFOLDS

VERSAMATIC PUMPS

PRICE	PART#	DESCRIPTION	INLET	OUTLET	DISTRIBUTION PORTS	PSI	MAX. FLUID TEMP	MOUNTING THREAD
\$24.11	VM7003022	Polypropylene (glass filled)	9/16-18" UNF	3/8-18" FNPT	1/4-18 FNPT	150	175°	1/4"



166 SERIES AIR DRIVEN PUMPS

PENTAIR SHURFLO AIR-DRIVEN PUMPS

- The Pentair Shurflo 166 Air Operated Demand Pumps employ a dual diaphragm design, with a patented fast action switching mechanism allowing for consistent flow and pressure. They are built for the toughest pumping applications and are available in a variety of elastomers that allow them to be compatible with mild caustic or acidic fluids. Ideal for chemical transfer, injection and spraying.
- 2-chamber dual diaphragm
- **Positive displacement**
- **On-demand operation**
- **BODY:** Polypropylene
- **PRESSURE:** 30-60 PSI
- **MAX TEMP:** 120° F
- **DIAPHRAGM:** Varies

PRICE	PART #	DIAPHRAGM
\$115.29	SF16620056	EPDM
\$103.17	SF16620036	Viton

8000 SERIES DIAPHRAGM PUMPS

PENTAIR SHURFLO DIAPHRAGM PUMPS

- The 8000 Series diaphragm pump is Pentair Shurflo's most widely used industrial pump. With spherically shaped valves and automatic demand switch, these pumps deliver consistent, dependable operation and priming. Up to 1.8 GPM (6.8 l/min).

PRICE	PART #	DESCRIPTION	GPM	PSI	PORT SIZE
\$134.41	SF8000151296	Low Flow Demand Pump W/ Internal Bypass 24 VDC	1	60	3/8"
\$141.08	SF8000343236	Standard Demand Pump 12VDC	1.2	60	3/8"
\$147.73	SF8000532256	Standard Demand Pump w/Internal Bypass 115VAC	1.4	60	3/8"
\$147.73	SF8000533236	Standard Demand Pump 115VAC	1.4	60	3/8"
\$135.13	SF8000533250	Standard Internal Bypass Pump 115VAC	1.4	50	3/8"
\$107.83	SF8000543236	Standard Demand Pump 12 VDC	1.8	60	3/8"
\$112.13	SF8000543238	High Pressure Demand Pump 12 VDC	1.8	100	3/8"
\$146.10	SF8000633236	Transfer Pump 115VAC	1.4	60	3/8"
\$120.45	SF8000643236	Standard Demand Pump 12 VDC	1.8	60	3/8"
\$169.73	SF8000812288	High Pressure Demand Pump w/Bypass 115VAC	1.4	100	3/8"
\$125.34	SF8005233236	Standard Demand Pump 115VAC	1.4	60	3/8"
\$150.02	SF8000713238	High Pressure Demand Pump 115VAC	1.6	100	3/8"
\$163.38	SF8000813238	High Pressure Demand Pump 115VAC	1.6	100	3/8"
\$168.70	SF8030813239	Standard Demand Pump 12 VDC	1.5	150	3/8"
\$128.00	SF8005733255	Standard Demand Pump w/Internal Bypass 115VAC	1.4	60	3/8"
\$107.83	SF8009543236	ShurFlo Pump 12VDC	1.8	60	3/8"
\$189.16	SF8020833238	ShurFlo Pump 115V	1.6	100	3/8"
\$44.20	SFK9439505	ShurFlo Viton Diaphragm Kit	For 8000-033-236 & 343-236		
\$14.74	SF9437900	Upper Housing	For 8000 Series Diaphragm Pumps w/o Bypass		

ALL PENTAIR BRANDS ARE TRADEMARKS OF PENTAIR.



Whether you need to pump water for your RV, marine, agricultural, automotive, or floor care operation, Pentair Shurflo pumps are the answer! Innovative designs and high performance materials combine to deliver a high quality electric diaphragm pump solution that many operators trust to provide easy, maintenance-free performance.

PENTAIR SHURFLO PUMPS



SLV SERIES PUMP

PENTAIR SHURFLO PUMPS

- Ideal for low volume intermittent duty applications requiring a compact pump with low power consumption.
- Unique design has no metal parts in the fluid path for maximum chemical resistance.
- Automatic demand operation and elastomers that handle a wide variety of fluids offer great versatility.
- Perfect for low volume spraying and transfer.
- **PORTS:** 3/8" Barb
- **VOLTAGE:** 12 VDC
- **FLOW:** 1 GPM
- **PSI:** Varies - see below
- **VALVES:** Viton

PRICE	PART #	DESCRIPTION	PSI
\$64.46	SFSLV10AA40	Automatic Demand Pump with Integral on/off Switch	40
\$61.10	SFSLV10AA41	Automatic Demand Pump	40



5050 SERIES PUMP

PENTAIR SHURFLO PUMPS

- Designed for high flow, SHURFLO's 5000 series pump design was created with a unique one-piece co-molded diaphragm, assuring long life and top performance in any system. The 5000 series pump is built for powerful, smooth flow. The 5000 series automatic demand pump is powerful and can run dry without damage.
- Pump Type - Demand
- **PORTS:** 1/2"
- **FLOW:** 5.3 GPM
- **PRESSURE:** 60 PSI
- **PUMP BODY:** Polypropylene
- **DIAPHRAGM:** Santoprene
- **VOLTAGE:** 12 VDC
- **VALVES:** Viton
- **SHUT-OFF:** 60 PSI

\$201.40 SF50501311D011



GENERAL PURPOSE PUMPS

PENTAIR SHURFLO PUMPS

- Compact, rugged and reliable, the 100 is a positive displacement pump for flooded inlet, low volume, and low-pressure applications. Perfect where a low volume fill pump is needed, the unique wobbler design has no valves, and can pump a wide range of chemicals and fluids. Available in 12 VDC. Pump must be mounted below the supply tank to prime. Not for applications that require dry running.
- Easy installation
- Unique design eliminates valves
- **OUTLET PORT:** 3/8" Barb
- **FLOW:** 1 GPM (open)
- **O-RINGS:** EPDM
- **INLET PORT:** 3/8" Barb
- **PRESSURE:** 15 PSI
- **LIP SEAL:**
- **HOUSING:** Ryton
- **VOLTAGE:** 12 VDC

\$46.79 SF10000021



2088 SERIES DIAPHRAGM PUMPS

PENTAIR SHURFLO PUMPS

- Deliver reliable performance in high flow, moderate pressure applications.
- They are used in a variety of spraying, and transferring applications
- They are available in a variety of chemical-resistant materials, can be mounted in any position, and are designed for easy maintenance.

PRICE	PART #	DESCRIPTION	GPM	PSI	PORT SIZE
\$128.51	SF2088343435	Standard Demand Pump 12 VDC	3.0	45	1/2"
\$200.21	SF2088394144	Standard Pump with 6' Power Cord 115VAC	3.0	40	1/2"
\$114.07	SF2088443144	Standard Demand Pump 12 VDC	3.5	45	1/2"
\$118.90	SF2088474144	Standard Demand Pump 24 VDC	3.0	45	1/2"
\$185.18	SF2088514144	Standard Demand Pump 12 VDC	4.0	45	1/2"
\$215.28	SF2088313445	Premium Pump w/Fin Cooled Motor 12 VDC	3.6	45	1/2"
\$178.71	SF2088514500	Bypass No Control Pump 12VDC	4.0	45	1/2"
\$170.07	SF2088594144	Standard Demand Pump 115VAC	3.0	45	1/2"
\$150.89	SF2088594154	Standard Demand Pump 115VAC	3.3	45	1/2"

ALL PENTAIR BRANDS ARE TRADEMARKS OF PENTAIR



NDP-5FPT SERIES PUMP

YAMADA AIR OPERATED DIAPHRAGM PUMPS



- **AIR EXHAUST:** 3/8" Female NPT (includes silencer)
- **AIR INLET:** 1/4" Female NPT (includes ball valve)
- **MAX. LIQUID TEMP.:** 180 °F (82 °C)
- **FLOW:** 3.1 GPM
- **AIR SUPPLY PRESSURE:** 20 to 100 PSI (1.4 to 7 kgf/cm²)
- **PORTS:** 1/4" Female NPT
- **O-RINGS:** Teflon
- **FLAT VALVE:** Teflon
- **DIAPHRAGMS:** Teflon
- **BODY:** Polypropylene

\$322.50 YANDP5FPT

NDP-5FPT SERIES PUMP KITS

YAMADA AIR OPERATED DIAPHRAGM PUMPS

\$126.00	YANDK5T	(2) 771093 - Diaphragm 5t, (4) 771094 - Flat Valve 5pp-T, (4) 643003 - O-Ring, (4) 643013 - O-Ring, (2) 643015 - O-Ring	(Old Style Repair Kit) For Models Before Serial #228480
\$126.00	YANDK5T-2	(2) 771093 - Diaphragm 5t, (4) 771094 - Flat Valve 5pp-T, (4) 643003 - O-Ring, (6) 643015 - O-Ring	(New Style Repair Kit) For Models After Serial #228480
\$170.00	YANDK5AM	(5) 771098 - Seal Ring, (1) 640002 - O-Ring, (1) 640017 - O-Ring, (2) 640000 - O-Ring, (2) 685752 - V-Packing, (2) 640139 - O-Ring, (1) 771980 - Gasket, (2) 771239 - Cushion, (2) 709319 - Spring, (1) 771465 - Filter, (6) 771097 - O-Ring, (1) 771132 - Tool 5/15	(Air Motor Rebuild Kit)

YADP10BPT POLYPROPYLENE/TEFLON DP-10 SERIES PUMP

YAMADA AIR OPERATED DIAPHRAGM PUMPS



- **AIR EXHAUST:** 3/8" Female NPT (includes silencer)
- **AIR INLET:** 1/4" Female NPT (includes ball valve)
- **MAX. LIQUID TEMP.:** 180 °F (82 °C)
- **FLOW:** 6.0 GPM
- **AIR SUPPLY PRESSURE:** 20 to 100 PSI (1.4 to 7 kgf/cm²)
- **PORTS:** 3/8" Female NPT
- **O-RINGS:** Teflon
- **FLAT VALVE:** Teflon
- **DIAPHRAGMS:** Teflon
- **BODY:** Polypropylene

\$446.25 YADP10BPT

YADP10BPT POLYPROPYLENE DP-10 SERIES PUMP KITS

YAMADA AIR OPERATED DIAPHRAGM PUMPS

\$172.00	YADK10PT	(2) 770933 - Diaphragm 10t, (4) 770931 - Ball 10t, (4) 643005 - O-Ring, (4) 643018 - O-Ring	Liquid Side Repair Kit
\$107.00	YANDK115AM	(2) 640131 - O-Ring, (4) 684900 - O-Ring, (1) 771358 - Gasket, (4) 684284 - V-Packing, (1) 801404 - Spool	Air Motor Rebuild Kit

NDP-15FPT SERIES PUMP

YAMADA AIR OPERATED DIAPHRAGM PUMPS



- **AIR EXHAUST:** 3/8" Female NPT (includes silencer)
- **AIR INLET:** 1/4" Female NPT (includes ball valve)
- **MAX. LIQUID TEMP.:** 180 °F (82 °C)
- **FLOW:** 13.5 GPM
- **AIR SUPPLY PRESSURE:** 20 to 100 PSI (1.4 to 7 kgf/cm²)
- **PORTS:** 1/2" Female NPT
- **O-RINGS:** Teflon
- **FLAT VALVE:** Teflon
- **DIAPHRAGMS:** Teflon
- **BODY:** Polypropylene

\$436.15 YANDP15FPT

NDP-15FPT SERIES PUMP KITS

YAMADA AIR OPERATED DIAPHRAGM PUMPS

\$163.00	YANDK15AM	(1) 771347 - Gasket, (1) 640022 - O-Ring, (1) 640002 - O-Ring, (6) 683123 - O-Ring, (5) 771484 - Seal Ring, (2) 771483 - Cushion, (2) 640144 - O-Ring, (2) 640020 - O-Ring, (2) 684284 - V-Packing, (2) 771342 - Cushion	Air Motor Rebuild Kit
\$196.00	YANDK15T	(8) O-Ring 643027, (4) Flat Valve 771340, (2) Diaphragm 770933, (4) O-Ring - 643005	Liquid Side Repair Kit

YAMADA® AIR OPERATED DIAPHRAGM PUMPS



YANDP15FPS-PLS POLYPROPYLENE/SANTOPRENE NDP-15 SERIES PUMP

YAMADA AIR OPERATED DIAPHRAGM PUMPS



- **AIR EXHAUST:** 3/8" Female NPT (includes silencer)
- **AIR INLET:** 1/4" Female NPT (includes ball valve)
- **MAX. LIQUID TEMP.:** 180 °F (82 °C)
- **FLOW:** 13.5 GPM
- **AIR SUPPLY PRESSURE:** 20 to 100 PSI (1.4 to 7 kgf/cm²)
- **PORTS:** 1/2" Female NPT
- **O-RINGS:** EPDM
- **FLAT VALVE:** Teflon
- **DIAPHRAGMS:** Santoprene
- **BODY:** Polypropylene

\$438.36 YANDP15FPS-PLS

YANDP15FPS-PLS POLYPROPYLENE NDP-15 SERIES PUMP KITS

\$130.00	YANDK15S	(2) 771972 - Diaphragm 10/15 Santoprene, (4) 771340 - Flat Valve 15t, (8) 684115 - O-Rings	Liquid Side Repair Kit
\$163.00	YANDK15AM	(1) 771347 - Gasket, (1) 640022 - O-Ring, (1) 640002 - O-Ring, (6) 683123 - O-Ring, (5) 771484 - Seal Ring, (2) 771483 - Cushion, (2) 640144 - O-Ring, (2) 640020 - O-Ring, (2) 684284 - V-Packing, (2) 771342 - Cushion	Air Motor Rebuild Kit

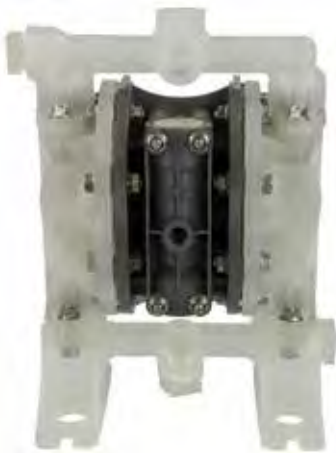

G15 SERIES PUMPS

YAMADA AIR OPERATED DIAPHRAGM PUMPS



- **AIR EXHAUST:** 3/8" Female NPT (includes silencer)
- **AIR INLET:** 1/4" Female NPT
- **MAX. LIQUID TEMP.:** 180 °F (100 °C)
- **FLOW:** 16.6 GPM
- **AIR SUPPLY PRESSURE:** 20-100 PSI (1.4 to 7 kgf/cm²)
- **PORTS:** 1/2" Female NPT
- **O-RINGS:** Teflon or Santoprene
- **FLAT VALVE:** Teflon or Santoprene
- **DIAPHRAGMS:** Teflon or Santoprene
- **BODY:** Polypropylene

PRICE	PART #	DIAPHRAGM, O-RINGS, BALLS
\$471.33	YAG15PS11	Santoprene
\$527.33	YAG15PT11	PTFE (Teflon)

G15 SERIES PUMP KITS

\$150.00	YAKG15PS	(2) 640147 O-Ring, (2) 773315 Diaphragm, (4) 773424 Ball, (4) 684114 O-Ring	Liquid Side Repair Kit
\$114.63	YAKG15-AM-P	(2) 686893 O-Ring, (4) 640015 O-Ring, (2) 684900 O-Ring, (1) 773407 Gasket, (2) 685135 O-Ring, (4) 771080 O-Ring, (1) 805208 Spool Assembly, (1) 773428 Cushion	Air Motor Repair Kit

STENNER® PUMPS



STENNER PUMP COMPANY

- Self-priming: No foot valve assemblies required
- Low maintenance: Primary modular components are replaceable without tools
- External dial ring allows full adjustment from 5 to 100% of maximum flow
- Wall or shelf mount
- Consistent output and uniform flow
- Ideal for hyper-concentrates and a wide variety of car wash solutions
- Pressure rated up to 100 PSI
- International voltages and connections available
- **PERISTALTIC ADVANTAGE** - With peristaltic pumps you don't need diaphragms or foot valves while allowing the system to be completely self-priming

85 SERIES SINGLE HEAD PUMP

- 120V single head pump
 - Select suction/discharge tubing size 1/4" or 3/8"
 - Select pump tube material*
- * Versilon is recommended for oil based chemicals (drying agents, waxes and polymer conditioners)

CALL FOR PRICING	PART #	CONN. SIZE	PUMP TUBE MATERIAL	MAX. OUTPUT
	SP85MJH7A3S	3/8"	Santoprene	3.6 oz./min.
	SP85MJH7A1S	1/4"	Santoprene	3.6 oz./min.
	SP85MJH2A1S	1/4"	Santoprene	1.5 oz./min.
	SP85MJH1A1S	1/4"	Santoprene	.45 oz./min.



GRACO® HUSKY PUMPS



HUSKY 307 SERIES

GRACO PUMPS

- **OUTLET PORT:** 3/8" NPTF
- **INLET PORT:** 3/8" NPTF
- **FLOW:** 6.5 GPM
- **PRESSURE:** 100 PSI
- **MAX TEMP.:** 150° F
- **BODY:** Polypropylene

\$459.80	GD32966	Santoprene
\$592.80	GD32911	Teflon
REPAIR KITS		
\$212.56	GDK263720	Santoprene
\$281.71	GDK03911	Teflon



HUSKY 515 SERIES

GRACO PUMPS

- **OUTLET PORT:** 1/2" NPTF
- **INLET PORT:** 1/2" NPTF
- **FLOW:** 15 GPM
- **PRESSURE:** 100 PSI
- **MAX TEMP.:** 150° F
- **BODY:** Polypropylene

\$592.04	GD52966	Santoprene
\$817.00	GD52911	Teflon
REPAIR KITS		
\$240.31	GDK5966	Santoprene
\$375.61	GDK5911	Teflon



HUSKY 205 SERIES

GRACO PUMPS

- **OUTLET PORT:** 1/4" NPTF
- **INLET PORT:** 1/4" NPTF
- **FLOW:** 5 GPM
- **PRESSURE:** 100 PSI
- **MAX TEMP.:** 180° F
- **BODY:** Polypropylene

\$337.44	GD12096	Santoprene
\$463.60	GD12091	Teflon
REPAIR KITS		
\$85.36	GDK01096	Santoprene
\$129.33	GDK01091	Teflon



HUSKY 1050 SERIES

GRACO PUMPS

- **OUTLET PORT:** 1" NPTF
- **INLET PORT:** 1" NPTF
- **FLOW:** 50 GPM
- **PRESSURE:** 125 PSI
- **BODY:** Polypropylene

\$1,330.00	GD649029	Santoprene
\$1,508.60	GD649034	Teflon



FAST-FLO 55 GALLON DRUM PUMP

GRACO PUMPS

- **CONSTRUCTION:** 304 Stainless Steel
- **PACKING:** PTFE
- **FLOW:** 4.0 GPM
- **MAX PRESSURE:** 180 PSI
- **MAX PUMP SPEED:** 100 CPM
- **AIR INLET:** 1/4"
- **FLUID OUTLET:** 3/4"
- Air powered for high reliability and low cost
- Continuous or dead end transfer

\$2,090.00	GD237129
-------------------	-----------------



AQUATEC PUMPS

5800 SERIES PUMPS

AQUATEC

- **PORTS:** 3/8" John Guest Push-to-Connect
- **DIAPHRAGM:** Santoprene
- **HOUSINGS:** Polypropylene
- **APPLICATION:** Pressurized water delivery

PRICE	PART #	PSI	GPM	MAX. TEMP	VOLTAGE	LEADS	PRIME
\$102.37	ATP1000	60	0.9	140°F	115 VAC/60 hz	12" motor leads	7 ft.
\$103.93	ATP1005	60	0.9	140°F	115 VAC/60 Hz	12" motor leads	5.5 ft.
\$103.93	ATP1010	60	1.22	140°F	115 VAC/60 Hz	12" motor leads	7 ft.
\$105.35	ATP1015	100	1.22	140°F	115 VAC/60 Hz	12" motor leads	7 ft.



5800 SERIES CARPET CLEANING EQUIPMENT PUMPS

AQUATEC

- **PORTS:** 3/8" NPT Female
- **DIAPHRAGM:** Santoprene
- **VALVES:** Viton
- **HOUSINGS:** Nylon
- **MAX TEMP:** 170°F
- **MAX. PRESSURE:** Varies, see chart
- **PRIME:** 9 feet
- **MOTOR LEADS:** 12"

PRICE	PART #	PRESSURE SWITCH	GPM	VOLTAGE
\$141.75	ATP1025	170 PSI	0.5 GPM @ 145 PSI w/ #2 nozzle tip	12 VDC
			0.98 GPM @ 90 PSI w/ #6 nozzle tip	
\$147.00	ATP1030	220 PSI	0.55 GPM @ 175 PSI w/ #2 nozzle tip	115 VAC
			0.98 GPM @ 90 PSI w/ #6 nozzle tip	
\$164.59	ATP1060	120 PSI	0.55 GPM @ 175 PSI w/ #2 nozzle tip	115 VAC
			0.98 GPM @ 90 PSI w/ #6 nozzle tip	



550 SERIES PUMPS

AQUATEC

- **PORTS:** 1/2" NPT Female
- **DIAPHRAGM:** Santoprene
- **VALVES:** EPDM
- **HOUSINGS:** Polypropylene
- **MAX TEMP:** 140°F
- **MAX. PRESSURE:** 60 PSI
- **PRIMARY APPLICATION:** beverage/drinking water
- **MOTOR LEADS:** 12"

PRICE	PART #	GPM	VOLTAGE	PRIME	PRICE	PART #	GPM	VOLTAGE	PRIME
\$104.98	ATP1040	3.2	115 VAC	10 ft.	\$111.29	ATP1050	4.25	12 VDC	11 ft.
\$139.65	ATP1045	3.2	115 VAC	10 ft.	\$111.29	ATP1055	4.5	24 VDC	10 ft.



Aquatec's 3-chamber and 5-chamber diaphragm pumps are used for a variety of water delivery applications. Commonly used either to pressurize water from an atmospheric tank, to deliver purified water to a specific point of use, or simply to increase pressure when required. Most models are designed for intermittent duty, although some models are rated for continuous operation.

Aquatec provides professional-quality pump systems for beverage and water delivery, industrial water transfer and floor care applications. Aquatec pumps feature thermal caps on motors for safe usage and temperature control.

Each Aquatec pump boasts reliable performance and great service life for your facility!

PUMP ACCESSORIES

REGULATORS, RELIEF VALVES & UNLOADERS



NICKEL PLATED ADJUSTABLE PRESSURE REGULATOR

KLEEN-RITE

KLEEN-RITE.com



- **MAX. PSI:** 2000
- **DISCHARGE:** 1/4" NPT-F
- **BYPASS:** 1/2" FPT
- Maintains pressure to within 5% of setting
- Regulates pressure, absorbs pulsation in system
- Dual function often eliminates need for accumulator
- **INLET:** 3/8" NPT-F
- **MAX. TEMP:** 190° F
- **MAX. FLOW:** 5.0 GPM

\$58.88	REK52	Unloader
\$4.99	REK52-PK	Repair Kit
\$13.31	REBR52E	Elbow Only



BALANCED UNLOADERS

KLEEN-RITE

KLEEN-RITE.com



- **INLET:** 3/8" FPT
- **MAX. TEMP:** 200° F
- **MAX. FLOW:** 8.0 GPM
- **SEALS:** Buna-N
- **DISCHARGE:** 3/8" FPT
- **BYPASS:** 1/4"
- **BODY:** Brass

PRICE	PART #	PSI	SPRING
\$73.98	RE7100	800-2000	Brown
\$96.01	RE7150	400-1000	Yellow
\$89.09	RE7300	1500-3000	Red
\$6.99	RE7100K	Repair Kit For All Models	



STAINLESS STEEL ADJUSTABLE PRESSURE REGULATOR

KLEEN-RITE

KLEEN-RITE.com



- **MAX. PSI:** 2000
- **MAX. TEMP:** 190° F
- **MAX. FLOW:** 13.0 GPM
- **INLET:** 3/8" NPT-F
- **OUTLET:** 1/2" NPT-F
- **MATERIAL:** SS, Viton, PTFE

\$89.23	REK132
----------------	---------------



BALANCED PRESSURE REGULATOR

KLEEN-RITE

KLEEN-RITE.com



- **MAX. PSI:** 2900
- **MAX. TEMP:** 195° F
- **MAX. FLOW:** 53 GPM
- **INLET:** 3/4" NPT-F
- **BYPASS:** 1/2" NPT-F
- **BODY:** Brass

\$163.35	REK5325
-----------------	----------------



BALANCED RELIEF VALVE

KLEEN-RITE

KLEEN-RITE.com

- **MAX. PSI:** 2450
- **MAX. TEMP:** 195° F
- **MAX. FLOW:** 6.3 GPM
- **INLET:** 3/8" BSPP-F
- **OUTLET:** 3/8" BSPP-F

\$33.20	REK624	Valve
\$8.26	REK624K	Repair Kit



REGULATING UNLOADER

CAT PUMPS



- Brass construction

PRICE	MODEL #	PSI	GPM
\$66.88	PU07581	232-2320	0.5-6.6



REGULATORS

CAT PUMPS



- Conical piston and seat facilitates smooth flow
- Flow-through design
- Consistent pressure for multiple pump or shut-off gun application
- Easy pressure control with adjustable nut

PRICE	MODEL #	PSI	GPM
\$371.88	PU07002	500-2000	0.5-5
\$463.75	PU7011	100-1000	1-10
\$485.63	PU07012	500-2000	1-10
\$982.50	PU07032	1000-2000	3.5-35



UNLOADERS

CAT PUMPS



- Minimum pressure fluctuations with alternating use of multiple guns
- Full system pressure maintained during bypass without full load on pump
- Bypasses flow from built up downstream changes for best pump protection
- Color coded spring

PRICE	MODEL #	PSI	GPM
\$171.88	PU07537	406-2320	1-21
\$177.50	PU07542	406-4060	1-21
\$87.50	PU7500	100-2000	0.5-6
\$154.38	PU07600	700-3500	2-5



T SHAPED BALANCED PRESSURE REGULATOR

J.E. ADAMS

J.E. ADAMS



- **MAX. PSI:** 2000
- **OUTLET:** 3/8" NPT
- **MAX. FLOW:** 7.0 GPM
- Brass construction with stainless steel inner seat and piston
- **INLET:** 3/8" NPT
- **MAX. TEMP:** 200° F

\$34.64	RE7085
----------------	---------------



L SHAPED BALANCED PRESSURE REGULATOR

J.E. ADAMS

J.E. ADAMS



- **MAX. PSI:** 2000
- **OUTLET:** 3/8" NPT
- **MAX. FLOW:** 7.0 GPM
- Brass construction with stainless steel inner seat and piston
- **INLET:** 3/8" NPT
- **MAX. TEMP:** 200° F

\$35.91	RE7075	Unloader
\$4.35	RE7075K	Repair Kit

PUMP ACCESSORIES

REGULATORS, RELIEF VALVES & UNLOADERS



BRASS REGULATING VALVE

GENERAL PUMP



- **PRESSURE:** 300 PSI
- **INLET:** 3/8" BSP-F
- **OUTLET:** 3/8" BSP-F
- **MAX. FLOW:** 6.3 GPM
- **MAX. TEMP:** 195° F

\$34.72 GPP100269

UNLOADERS ARE TYPICALLY DESIGNED FOR...
a single gun or single pump operation. The unloader will maintain set system pressure with the trigger gun open and goes into bypass with the release of the trigger.

UNLOADERS ARE NOT RECOMMENDED FOR...
Weep systems. 5-10% in bypass is recommended for optimum performance.



BRASS REGULATING VALVE

GENERAL PUMP



- **PRESSURE:** 2500 PSI
- **INLET:** 3/4" NPT-F
- **OUTLET:** 1/2" NPT-F
- **MAX. FLOW:** 45 GPM
- **MAX. TEMP:** 195° F
- Regulates pressure and protects against spikes
- Grease zerk keeps the piston and seal lubricated
- Compatible with General Pump Emperor HTCK pumps
- Multiple connection points
- Lubricated piston and seal
- Durable brass body
- Great for in-bay automatic car washes
- **PLEASE NOTE:** if this valve is installed with a positive displacement pump, the manufacturer recommends incorporating a safety relief device (not included)

\$143.62 GPCWR4525

BALANCED PRESSURE REGULATORS

THE SPECIALTY MFG. CO.

THE SPECIALTY MFG. CO.
Custom to Our Specialty



- **PRESSURE:** 200-2000 PSI
- **INLET:** 3/8" FPT
- **MAX. TEMP:** 180° F
- **OUTLET:** 1/2" NPT-F
- **MAX. FLOW:** 7.0 GPM
- Designed for car wash and pressure wash applications where a weep gun is used or bypass can be returned to the supply tank. Offers instant response
- Buna-N, Ethylene Propylene and Fluoroelastomer (Viton®) seals are available for chemical compatibility
- Available with three standard spring pressure ranges to 2000 PSI
- Can be used in systems with more than one outlet
- Mounts to a "T" from the pump outlet and is repairable

PRICE	KR PART #	DESCRIPTION	SMC PART #
\$40.37	RE55590	Brass	5550090
\$115.81	RE55590SS	Stainless Steel	5551390

PRICE	KR PART #	DESCRIPTION	SMC PART #
\$40.37	RE55590L	Brass With Spring	5551090
\$5.68	RE55590K	Repair Kit	5550490

FLOW THRU BALANCED PRESSURE REGULATOR

THE SPECIALTY MFG. CO.

THE SPECIALTY MFG. CO.
Custom to Our Specialty



- **PRESSURE:** 200-2000 PSI
- **INLET:** 3/8" FPT
- **MAX. TEMP:** 180° F
- **MAX. FLOW:** 7.0 GPM
- Designed for car wash and pressure wash applications where a weep gun is used or bypass can be returned to the supply tank. Offers instant response
- Buna-N, Ethylene Propylene and Fluoroelastomer (Viton®) seals are available for chemical compatibility
- Can be used in systems with more than one outlet
- Mounts to the pump outlet with a flow through "T-Body" & is repairable

PRICE	KR PART #	DESCRIPTION	SMC PART #
\$44.70	RE55690	Regulator	5551890
\$5.68	RE55590K	Repair Kit	5550490

DIRECT PILOT - NORMALLY OPEN AIR OPERATED SHUT OFF VALVE

LEXAIR

Lexair Inc.



- **MAX. PRESSURE:** 1000 PSI
- **PORTS:** 1" FPT
- **COMPONENTS:** Bronze, brass, stainless steel
- For use in high-pressure lines and change over between spray arch and underbody on PDQ LaserWash 4000 automatic car wash - Valve replacement used in PDQ Car Wash Systems
- Large resilient poppet provides bubble-tight closure - single, direct operated poppet design
- Easy-remove Pilot Cap for quick access to one-piece poppet assembly
- O-ring on poppet and U-cup pilot piston seal prevent controlled and pilot media from mixing, permitting use of different media for pilot/control

\$485.19	LX4136202	Valve
\$139.71	LX4136002	Repair Kit

PUMP ACCESSORIES



GENERAL PUMP® UNLOADERS



BLUE SPRING TRAPPED PRESSURE UNLOADER VALVE

GENERAL PUMP

- **PRESSURE:** 4500 PSI | New GP: 4060 PSI
- **INLET:** 3/8"
- **OUTLET:** 3/8"
- **MAX. FLOW:** 10.5 GPM
- **MAX. TEMP:** 195° F

\$52.27	GPU831D	Original GP Version (PA)
\$49.19	GPUZH284	New GP Version - Interpump



BRASS UNLOADER VALVE

GENERAL PUMP

- **PRESSURE:** 2450 PSI | New GP: 2465 PSI
- **INLET:** 1"
- **MAX. FLOW:** 53 GPM
- **MAX. TEMP:** 200° F

\$361.99	GPU5221	Original GP Version (PA)
\$328.57	GPUZH1520	New GP Version - Interpump



WHITE SPRING TRAPPED PRESSURE UNLOADER VALVE

GENERAL PUMP

- **PRESSURE:** 2600 PSI | New GP: 2300 PSI
- **INLET:** 3/8"
- **OUTLET:** 3/8"
- **MAX. FLOW:** 10.5 GPM
- **MAX. TEMP:** 195° F

\$52.37	GPU815D	Original GP Version (PA)
\$53.62	GPUZH224	New GP Version - Interpump



ADJUSTABLE TRAPPED PRESSURE UNLOADER VALVE

GENERAL PUMP

- **PRESSURE:** 2600 PSI | New GP: 2300 PSI
- **INLET:** 3/8" NPT-F
- **OUTLET:** 3/8" NPT-F
- **MAX. FLOW:** 10.5 GPM
- **MAX. TEMP:** 195° F

\$54.73	GPU4KLP	Original GP Version (PA)
\$53.62	GPUZH224K	New GP Version - Interpump



EZ START TRAPPED PRESSURE UNLOADER

GENERAL PUMP

- **PRESSURE:** 4500 PSI | New GP: 4060 PSI
- **INLET:** 3/8" FNPT
- **OUTLET:** 3/8" FNPT
- **MAX. FLOW:** 10.5 GPM
- **MAX. TEMP:** 195° F

\$53.27	GPU4KHP	Original GP Version (PA)
\$53.76	GPUZH284K	New GP Version - Interpump

New!



ZH288 DUAL 1/2" BYPASS UNLOADER VALVE

GENERAL PUMP

- **PRESSURE:** 4060 PSI
- **INLET:** 1/2" FNPT
- **OUTLET:** 1/2" FNPT
- **MAX. FLOW:** 21.1 GPM
- **MAX. TEMP:** 185° F

\$116.26	GPUZH288
-----------------	-----------------

New!



ZH168 DUAL 1/2" BYPASS UNLOADER VALVE

GENERAL PUMP

- **PRESSURE:** 2320 PSI
- **INLET:** 1/2" FNPT
- **OUTLET:** 1/2" FNPT
- **MAX. FLOW:** 21.1 GPM
- **MAX. TEMP:** 185° F

\$116.26	GPUZH168
-----------------	-----------------



PUMP ACCESSORIES

REGULATORS & UNLOADERS



REGULATOR/UNLOADER SUTTNER



- **INLET:** 3/8" FPT
- **OUTLET:** 3/8" FPT
- **BYPASS:** 1/4"
- **MAX. TEMP:** 176° F
- **MAX. FLOW:** 8.0 GPM
- **PRESSURE:** 500-4060 PSI
- **SEALS:** Viton
- Pressure sensitive - full adjustable PSI
- For single or multiple gun systems

\$71.73 SUT280



REGULATOR/UNLOADER SUTTNER



- **INLET:** 3/8" FPT
- **OUTLET:** 3/8" FPT
- **BYPASS:** 1/4"
- **MAX. TEMP:** 176° F
- **MAX. FLOW:** 8.0 GPM
- **PRESSURE:** 500-3625 PSI
- **SEALS:** Viton & PTFE
- Allows limit setting on max & min pressure

\$54.73 SUT261



BYPASS REGULATOR BALANCED RELIEF VALVE SUTTNER



- **INLET:** 1/4" FNPT
- **BYPASS:** 1/4" FNPT
- **MAX. TEMP:** 200° F
- **MAX. FLOW:** 8.0 GPM
- **MAX. PSI:** 3600
- **HOUSING:** Brass
- Valve member rides on elastomeric cushion which eliminates metal-to-metal contact, which is a common cause of failure
- Stainless steel piston and seat
- Ideal for weep gun systems
- Mountable "off-line"

\$38.08 SUT230 Bypass Regulator Balanced Relief Valve
\$23.51 SUT230KN Repair Kit



HIGH FLOW REGULATOR PENTAIR HYPRO



- **MAX. PSI:** 2000
- **MAX. FLOW:** 55 GPM
- **MAX. TEMP:** 185° F
- Balanced design allows for smooth transitioning from regulating to relief without damaging pressure spikes to the pump system
- Provides system pressure setting and protection for single or multiple gun and pump systems from 20 gpm to 55 gpm

\$545.38 HYP33000102



BALANCED RELIEF VALVE AR NORTH AMERICA



- **MAX. PSI:** 4040
- **MAX. FLOW:** 6.6 GPM
- **INLET:** (2) 3/8" FPT
- **OUTLET:** (2) 3/8" FPT
- **MAX. TEMP:** 194° F
- **HOUSING:** Brass

\$30.37 ARSVT28



UNLOADER

AR NORTH AMERICA



- **MAX FLOW:** 10.5 GPM
- **HOUSING:** Brass
- **MAX TEMP:** 194° F
- **INLET:** (2) 3/8" FPT
- **OUTLET:** 3/8" FPT
- **BYPASS:** (2) 3/8" FPT
- May be used for variable pressure adjustment
- Diverts water flow into bypass when the trigger gun valve is closed

PRICE	PART #	PSI	SPRING
\$44.27	ARVRT3160	2320	Yellow
\$44.27	ARVRT3250	3650	Blue
\$44.25	ARVRT3310	4500	Black

ALL PENTAIR BRANDS ARE TRADEMARKS OF PENTAIR.

PUMP ACCESSORIES



GENERAL PUMP® UNLOADERS

PMRPULSAR4KHPEZ PUMPS MADE READY COMPLETE UNLOADER KIT

GENERAL PUMP



- **PRESSURE:** 4050 PSI rated | 4500 PSI max
- **MAX. FLOW:** 10 GPM

KIT INCLUDES:

- PULSAR4KHPEZ Trapped Pressure Unloader Valve
- 680017 Inlet Fitting Assy, Long, 1/2" NPT, 1/4" Port, Capped
- 700004 Filter Washer
- 680110 Seal Ring, 1/2" BSPP
- 639387 Hose, 3/8" ID, 250 PSI BLK
- 639897 Hose Clamp, Crimp Type, 39/64" to 47/64", 9/32" WD
- 638147 3/8" Hose Barb x 1/4" NPT
- 638148 3/8" Hose Barb x 3/8" NPT
- 639298 Adapter, Hex, 3/8" BSPP-M x 3/8" NPT, Steel, 5000 PSI
- 680029 Washer, Face Seal, 3/8" BSP
- D11009 Plug, 3/8" QC x 3/8" NPT-M, Zinc Plated Steel, Hardened
- D10004 Coupler, 3/8" QC x 3/8" NPT-M, Brass
- 400128 Warning Label, Prop. 65, 1.5" x .25"
- 639385 Fitting, 1/2" F-NPT x 1/2" BSPP

\$76.05 GPU4KHP-EZ-PMR

TRAPPED PRESSURE UNLOADER

GENERAL PUMP

SPECIFICATIONS:

- **PRESSURE:** 2175 PSI
- **INLET:** 1" NPTF
- **OUTLET:** 1" NPTF
- **MAX. FLOW:** 52.5 GPM
- **BYPASS:** 1" NPTF
- **MAX. TEMP:** 200° F

FEATURES:

- Features pressure-sensitive, high-pressure unloader valves that are designed to trap pressure when the gun is closed and drop bypass pressure to zero
- Immediate pressure available when gun is opened
- Sturdy steel and brass materials
- Check valve has a hexagonal shape to avoid jamming
- User may adjust pressure by screw and locknut for easy use and maintenance

\$361.99 GPU5221

General Pump recommends using a safety relief device in conjunction with this unloader valve when installed on a positive displacement pump.



TRAPPED PRESSURE UNLOADER

GENERAL PUMP

SPECIFICATIONS:

- **MAX. FLOW:** 10.5 GPM
- **INLET:** (2) 3/8" NPT-F
- **OUTLET:** 3/8" NPT-F
- **BYPASS:** (2) 3/8" NPT-F
- **MAX. TEMP:** 195° F

FEATURES:

- Features pressure-sensitive, high-pressure unloader valves that are designed to trap pressure when the gun is closed and drop bypass pressure to zero
- Immediate pressure available when gun is opened
- Minimal maintenance
- Reliably maintains consistent pressure

PRICE	PART #	SPRING COLOR	PSI
\$52.37	GPU815D	White	2600
\$52.27	GPU831D	Blue	4050

GPU831D



K7 SERIES UNLOADER

GENERAL PUMP

- **MAX TEMP:** 165° F
- **PRESSURE:** 3500 PSI
- **INLET:** 3/8" FPT
- **BYPASS:** 3/8" FPT
- **OUTLET:** 3/8" MPT
- **MATERIAL:** Brass, Stainless Steel

- Valves require a minimum of 5% bypass at ALL times!
- Bypass Restrictor eliminates high pressure in all lines while unit is in bypass mode
- Easy maintenance & service
- Best for single pump or non-weep guns
- Precise pressure adjustment
- Gradual pressure build up when system is closed
- No external moving parts or springs

PRICE	PART #	GPM	PRICE	PART #	GPM
\$114.06	GPUZK70	2.1-2.9	\$114.06	GPUZK72	4.2-6.6
\$114.06	GPUZK71	3-4.2	\$114.06	GPUZK73	6.6-10.8

FLOW SENSITIVE



PUMP ACCESSORIES



GENERAL PUMP® UNLOADERS

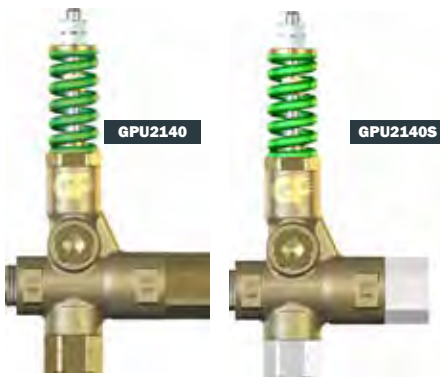

TRAPPED PRESSURE UNLOADER (GREEN SPRING)

GENERAL PUMP



SPECIFICATIONS:

- MAX. FLOW: 21 GPM
- MAX. TEMP: 200 °F
- INLET: (2X) 1/2" NPT-F
- OUTLET: 1/2" NPT-F
- BYPASS: (2X) 1/2" NPT-F
- MAX. PSI: 4500
- RATED PSI: 4050

FEATURES:

- Adjustable
- Reduced pressure loss
- Streamlines gun operation
- Reliable service and simple maintenance

\$136.15	GPU2140	Brass with Stainless Steel Components
\$162.23	GPU2140S	Brass with Stainless Steel Inlet/Outlet Port Fittings



ADJUSTABLE TRAPPED PRESSURE UNLOADER (YELLOW SPRING)

GENERAL PUMP



SPECIFICATIONS:

- MAX. FLOW: 21 GPM
- MAX. TEMP: 200 °F
- INLET: (2X) 1/2" NPT-F
- OUTLET: 1/2" NPT-F
- BYPASS: (2X) 1/2" NPT-F
- MAX. PSI: 2600
- RATED PSI: 2300

FEATURES:

- Updated design surpasses previous models
- Reduced pressure loss
- Streamlines gun operation
- Reliable service and simple maintenance
- Brass housing with a yellow spring

\$136.15	GPU2121
-----------------	----------------

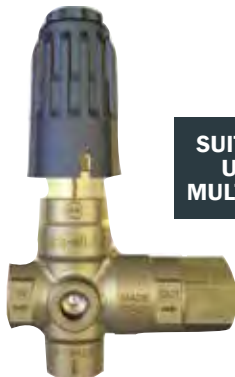

SUITABLE FOR USE WITH MULTIPLE GUNS

PRESSURE TRAPPING UNLOADER

GENERAL PUMP

SPECIFICATIONS:

- MAX FLOW: 21 GPM
- RATED PSI: 4050
- MAX TEMP: 195 °F
- Max PSI: 4500
- INLET: 1/2" NPT-F
- OUTLET: 1/2" NPT-F
- BYPASS: 1/2" NPT-F
- MATERIALS: Brass, Stainless Steel

FEATURES:

- Maintains consistent pressure - avoid dangerous spikes
- Includes high temp brass components
- For continual temperatures up to 185° F and short periods at 195°F

\$137.00	GPU4021B
-----------------	-----------------

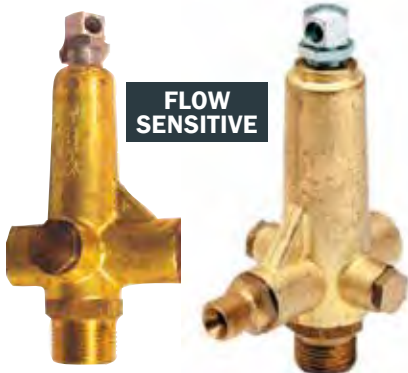

K3 & K5 SERIES UNLOADERS

GENERAL PUMP

SPECIFICATIONS:

- MAX. TEMP: 165° F
- INLET: 3/8" FPT
- BYPASS: 3/4" MPT
- OUTLET: 3/8" MPT
- MATERIAL: Brass, Stainless steel

FEATURES:

- Motors draw less amps, engines run with less load during unloading cycle
- No external moving parts or springs
- Piston design allows precise pressure adjustment
- Best for single pump or non-weep guns

K3 SERIES

REGULATORS & UNLOADERS

PRICE	PART #	PSI	GPM
\$89.61	GPUZK30	1450	2.1-3.0
\$89.61	GPUZK31	1450	3-4.2
\$89.61	GPUZK32	1450	4.2-5.5

K5 SERIES

REGULATORS & UNLOADERS

PRICE	PART #	PSI	GPM
\$95.14	GPUZK51	1450-3000	3.0-4.2
\$95.14	GPUZK52	1400-3000	4.2-6.6
\$95.14	GPUZK53	1450-3000	6.6-10.8

PUMP ACCESSORIES

REGULATORS, UNLOADERS & RELIEF VALVES



BYPASS PRESSURE REGULATORS

U.S. PARA PLATE



- Accurate, repeatable bypass regulation
- Continually regulates pressure within 5% of setting
- Can be set up to both regulate and absorb normal pulsation, eliminating the need for pulsation dampener
- Can be parallel mounted
- Designed for weep systems
- Not recommended for use with single or two cylinder pumps

PRICE	PART #	PSI	GPM	INLET	OUTLET
\$79.16	REBR52	750-2000	5	3/8"	1/4"
\$213.38	REBR101	100-1000	10	1/2"	1/4"
\$209.63	REBR1015	500-1500	10	1/2"	1/4"
\$220.06	REBR102	750-2000	10	1/2"	1/4"



WATER PRESSURE REGULATOR

WATTS REGULATORS



- **MAX. PRESSURE:** 10-125 PSI
- **DIMENSIONS:** 4 3/8" x 2 1/8"
- **MAX. TEMP:** 140° F

NOW LEAD FREE

PRICE	PART #	SIZE	DESCRIPTION
\$294.97	RE263A4	1/4"	With 1/4" Port
\$325.73	RE263A6	3/8"	With 1/4" Port
\$360.00	RE263A8	1/2"	With 1/4" Port
\$271.35	RE26A4	1/4"	No Port
\$271.35	RE26A6	3/8"	No Port
\$349.99	RE26A8	1/2"	No Port
\$34.90	RE26ARK		Repair Kit



REBR52 SERIES BYPASS PRESSURE REGULATOR KITS

U.S. PARA PLATE



PRICE	PART #	DESCRIPTION
\$10.23	REBR52K	Repair Kit
\$13.31	REBR52E	Elbow
\$19.92	REBR52S	Stem

REBR10 SERIES BYPASS PRESSURE REGULATOR KITS

U.S. PARA PLATE



PRICE	PART #	DESCRIPTION
\$14.58	REBR10K	Repair Kit
\$13.58	REBR10E	Elbow
\$30.34	REBR10S	Stem



DIAPHRAGM PRESSURE REGULATING VALVE

SPRAYING SYSTEMS CO.

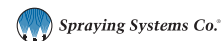

- Throttling valves regulate flow in systems equipped with centrifugal pumps
- Adjustable pressure relief valves accurately control spray line pressures – liquid waste caused by excessive pressures is minimized as excess liquid is bypassed back to the liquid source or pump inlet

PRICE	PART #	PSI	MATERIAL	INLET
\$41.43	RES8460	300	Nylon Body	1/2"
\$43.08	RES8460-12	300	Plastic	3/4"
\$103.10	RE6815	700-1200	Brass, stainless steel body with hardened stainless steel guide seat and inlet adapter	1/2"



BACK PRESSURE REGULATOR

U.S. PARA PLATE



- Regulates pressure and absorbs normal pulsation
- Repeatable and accurate setting
- Regulates press, within 5% (regardless of flow rate)
- Standard temp. 250° (higher ranges available)
- Easily maintained

\$383.33 **RE13166**



PRESSURE RELIEF VALVE

SPRAYING SYSTEMS CO.

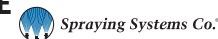

- **MAX. PRESSURE:** 300 PSI
- **CONSTRUCTION:** Brass

\$49.97	RES110300	3/8" M x F
\$37.62	RES110300-1/4	1/4" M x F



HIGH CAPACITY PRESSURE REGULATOR

GENERANT



- **SIZE:** 1/2" with 4 ports
- **MATERIAL:** Brass Body
- **MAX. PRESSURE:** 125 PSI
- Spring reference, fully balanced

PRICE	PART #	DESCRIPTION
\$90.55	G4HC500B	Pressure Regulator
\$33.42	GHC200B	Repair Kit

A REGULATOR IS DESIGNED FOR...

single or multiple pumps, weep or multi-nozzle systems. A regulator maintains set system pressure even when only one of several guns or nozzles is performing bypassing the unused flow. 5-10% in bypass is recommended for optimum performance.

PUMP ACCESSORIES



REGULATORS, UNLOADERS & RELIEF VALVES



PRESSURE ACTUATED UNLOADERS

GIANT

- **MAX. PSI:** 3000
- **MAX. FLOW:** 8.0 GPM
- **INLET:** 3/8" FNPT
- **OUTLET:** 3/8" FNPT
- **MAX. TEMP:** 160° F
- **BYPASS:** 2 x 1/4" BSP
- **MATERIALS:** Brass, stainless steel
- **USE:** Multiple guns

PRICE	PART #	DESCRIPTION
\$92.12	PU22760	Unloader
\$5.20	PU09108	Repair Kit

RECOMMENDED FOR
CAT PUMPS 310 PUMP!

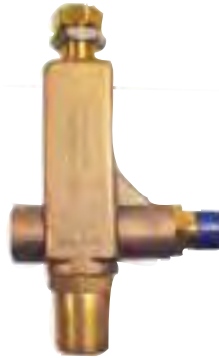

FLOW ACTUATED UNLOADERS

GIANT

- **INLET:** 3/8" FPT
- **OUTLET:** 3/8" FPT
- **MAX. TEMP:** 160° F
- **MATERIALS:** Wetted stainless steel
- **HOUSING:** Brass
- **INFO:** Press. unloaded to zero during bypass and is not trapped in discharge line

PRICE	PART #	GPM	PSI	REPAIR KIT
\$151.94	PU22654A	3.5-4.8	4000	PU22666A
\$104.55	PU22648	1.5-4.0	3000	-
\$104.55	PU22655	3.0-5.5	3000	PU22666
\$104.55	PU22656	4.5-6.5	3000	PU22666
\$102.38	PU22650	3.0-4.5	3000	PU22666A



ADJUSTABLE UNLOADERS

GIANT

- **INLET:** 1/2" FNPT
- **OUTLET:** 1/2" FNPT
- **BYPASS:** 1/2" BSP
- **MAX. TEMP:** 160° F
- **ACCESSORY PORTS:** 4 x 1/4"
- **FLOW:** 1.3 - 13.0 GPM
- **MATERIALS:** Wetted stainless steel
- **HOUSING:** Bronze
- **USE:** Multiple guns

PRICE	PART #	GPM	PSI	COLOR
\$127.46	PU22910	13	375 - 800	Silver
\$98.50	PU22911	13	375 - 1450	Yellow
\$98.50	PU22912	13	375 - 2000	Red
\$98.50	PU22913	13	725 - 3000	Orange
\$20.76	PU12099	Repair Kit		



PRESSURE ACTUATED HIGH FLOW UNLOADERS

GIANT

- **MAX. PSI:** 1740
- **INLET:** 3/4" FNPT
- **OUTLET:** 3/4" FNPT
- **BYPASS:** 3/4" BSP
- **SIDE PORTS:** (4) 1/4" FPT
- **FLOW:** 35 GPM
- **MATERIALS:** Wetted stainless steel
- **HOUSING:** Bronze

PRICE	PART #	DESCRIPTION
\$321.35	PU22971	Unloader
\$124.99	PU09461	Repair Kit



PRESSURE REGULATOR/RELIEF VALVE

GIANT

- **PRESSURE:** 2000 PSI
- **BYPASS:** 3/8" FNPT
- **MAX. TEMP:** 160° F
- **HOUSING:** Brass
- **INLET:** 3/8" FNPT
- **FLOW:** 10 GPM
- **SEALS:** Buna-N

\$34.66	PU21905
----------------	----------------



BRASS REGULATOR

GIANT

- **PRESSURE:** 50-150 PSI
- **BYPASS:** 3/8" FNPT
- **FLOW:** 10 GPM
- **MATERIALS:** Wetted stainless steel
- **INLET:** 3/8" FNPT
- **MAX. TEMP:** 160° F
- **HOUSING:** Brass

\$34.66	PU21906
----------------	----------------



PRESSURE REGULATOR/RELIEF VALVE

GIANT

- **MAX. PSI:** 2000
- **MAX. TEMP:** 160° F
- **MATERIALS:** Brass
- **BYPASS:** 3/8" FNPT
- **INLET:** (2) 3/8" FNPT
- **MAX. FLOW:** 10.0 GPM
- **SEALS:** Buna-N

\$36.25	PU21905F
----------------	-----------------



HELPFUL HINT!

PURCHASING A PRESSURE REGULATOR?

Make sure you get a pressure gauge to go with it!



PUMP ACCESSORIES

REGULATORS



C24 1-1/4" NPT

C23 1" NPT

C22 3/4" NPT

REGULATION VALVES

HYDRDA-CELL REGULATORS

HYDRA-CELL®
SEAL-LESS PUMP TECHNOLOGIES

- C Series Hydra-Cell valves bypass system fluid to prevent excess system pressure. When a system discharge is completely closed - such as a closed spray gun, closed valve or plugged nozzle - the Hydra-Cell valve bypasses the total system fluid flow. Balance system pressure for multiple-gun operations.
- For service, simply remove the top of the body and replace the worn internal components. Valves can be serviced in place without removing any fittings or plumbing.
- Heavy-duty construction
- Flow-through design
- Immediate response

PRICE	PART #	GPM	PSI	TEMP	INLET	OUTLET
\$260.65	WPC22ABBNSSEF	10	1000	200°	3/4"	3/4"
\$368.55	WPC23ABBNSSJG	20	1000	200°	1"	1"
\$924.30	WPC24ABBNSSNH	40	1000	200°	1-1/4"	1-1/4"



1/4" LUBRICATOR FOR AIR SYSTEM

IMI NORGREN



- Compact design
- Provides air line lubrication to one or more air driven tools or other devices
- Nearly constant oil density output with varying airflow
- All around (360°) visibility of the sight-feed dome simplifies installation and adjustment
- Screw-on bowl reduces maintenance time
- Can be disassembled without the use of tools or removal from the air line

\$59.53 REL720



REN2214

REN201FR

MINI/FILTER REGULATOR

IMI NORGREN



- Use for air or liquid

PRICE	PART #	SIZE	TYPE
\$53.43	REN201FR	1/4"	Filter
\$25.46	REN2212	1/8"	Composite
\$31.99	REN2214	1/4"	Brass



1/4" COMPRESSED AIR REGULATOR

IMI NORGREN



- Has a snap action knob to set the desired pressure
- Handles a flow rate of 15 SCFM.
- Pressure level adjusts from 5 to 100 PSI and handles a maximum of 300 PSI

\$25.46 REN2214C



3/8" PRESSURE REGULATOR

IMI NORGREN



- **MAX. INLET PRESSURE:** 150 PSI
- **TEMP. RANGE:** -30° - 175° F
- Allows reduction of downstream pressure when the system is dead-ended
- Does not include a pressure gauge

\$65.40 REN2216



R72G SERIES PRESSURE RELIEVING REGULATOR

IMI NORGREN



- Allows for inline or modular installation of air preparation components for easy mix, match, and adjustment of your system
- Features uni-directional flow, PTF threads, knob adjustment, and relieving diaphragm
- Includes gauge

\$60.24 REN2213



3/8" COMPRESSED AIR REGULATOR

IMI NORGREN



- Made with corrosion resistant brass
- Handle maximum pressure of 400 PSI
- Max Temperature: 200° F
- Not for potable water

\$178.49 REN2215

PUMP ACCESSORIES

REGULATORS

MINI REGULATOR

IR ARO REGULATORS



- **PRESSURE RANGE** 0-125 PSI
- **MAX. INLET PRESSURE:** 250 PSI
- Ideal choice where a small, compact unit is required to provide accurate control of either air or water flow.
- A stainless steel valve spring is the only metallic part to come in contact with the regulated medium

PRICE	PART #	SIZE	DESCRIPTION
\$23.03	REA127142	1/4"	Composite
\$24.89	REA27122	1/4"	Brass
\$34.21	REA129121	1/4"	Composite Filter
\$24.89	REA27120	1/8"	Brass
\$6.89	APP29668		Bracket
\$2.85	APP104094		Panel Nut For Bracket



REA127142

REA27122

REA129121



BRACKET



ZERO PRESSURE REGULATOR

REGULATORS

- Zero Pressure Regulator offers an entirely new approach to chemical metering into pumping systems using pressurized water supplies. The use of this regulator eliminates the need for troublesome float tanks with their inherent problems of corrosion, leakage, stuck float valves, clogged filter screens and excessive space requirements.

PRICE	PART #	DESCRIPTION
\$75.29	RE1000A	Weep
\$76.24	RE1000A1	Non-Weep

PRICE	PART #	DESCRIPTION
\$33.58	RE1000A1K	Kit for Non-Weep
\$40.14	RE1000AK	Kit for Weep



KLEEN-RITE CORP.
YOUR RELIABLE SUPPLIER FOR THE CAR WASH INDUSTRY

>>> FAST SHIPPING!

1 Day 
2 Day 
3 Day 

PUMP ACCESSORIES

REGULATORS



MODULE/AIR 2000 PIGGYBACK FILTER

IR ARO



- MAX. INLET PRESSURE: 200 PSI
- FILTER: 40 Micron
- TEMP. RANGE: 0° - 125° F
- Polycarbonate bowl with bowl guard
- Manual drain
- 1/4" gauge included

PRICE	PART #	SIZE/DESCP.
\$100.80	REA29231	3/8"
\$100.63	REA29241	1/2"
\$19.87	REA104405	Wall Bracket



MODULE/AIR 3000 PIGGYBACK FILTER

IR ARO



- MAX. INLET PRESSURE: 140 PSI
- FILTER: 40 Micron
- TEMP. RANGE: 14° - 140° F
- Extends life of air operated equipment
- Polycarbonate bowl with bowl guard
- Automatic drain

PRICE	PART #	SIZE
\$155.09	REA39354	3/4"
\$100.63	REA29241	1/2"



1000 SERIES AIR FILTER

IR ARO



- MAX PRESSURE: 175 PSI

PRICE	PART #	SIZE
\$64.60	REA125221	1/4"
\$65.93	REA12531	3/8"
\$82.59	REA12541	1/2"



1/4" LARGE BODY LUBRICATOR

PARKER LUBRICATORS



- Proportional oil delivery over a wide range of air flows
- Precision needle valve assures repeatable oil delivery & provides simple adjustment of delivery rate
- Bowl can be filled while air line is under pressure
- Transparent sight dome for 360° visibility

\$122.93	REPL118
-----------------	----------------



FILTER REGULATOR

PARKER



- PRESSURE RANGE: 2-125 PSI
- FILTER: 40 Micron
- SIZE: 1/2" NPT
- One-unit combo compressed air filter/regulator
- Polycarbonate bowl with metal bowl guard
- Gaugeless relieving filter regulator
- Manual drain

\$186.87	REP413
-----------------	---------------



COMPOSITE FILTER REGULATOR

PARKER



- MAX. PRESSURE: 120 PSI
- FILTER: 5 Micron
- SIZE: 1/4" FPT
- GAUGE PORT: 1/8"
- For use with air pumps
- Polycarbonate bowl
- Manual drain

\$49.82	REPL3FA
----------------	----------------



REP119



REP113

COMPOSITE REGULATORS

PARKER REGULATORS



- Use for air or liquid

PRICE	PART #	SIZE
\$26.41	REP118	1/8"
\$69.87	REP113	1/4" Large body
\$26.41	REP119	1/4"
\$72.14	REP213	3/8"
\$115.92	REP313A	1/2"



BRASS MINI REGULATOR

PARKER REGULATORS



- Use for air or liquid

PRICE	PART #	SIZE
\$25.96	REM362	1/8"
\$23.46	REM364	1/4"

PUMP ACCESSORIES



REGULATORS



MINI/FILTER REGULATOR

SMC PNEUMATICS



- **PORTS:** 1/4" NPT
- **OPERATING PSI:** 0 - 145
- **TEMP. RANGE:** 23° to 140°F (with no freezing)
- **FILTER ELEMENT:** 5 micron
- Low profile embedded gauge
- SMC 20 series filter/regulator with gauge

PRICE	PART #	MFG. PART #
\$32.43	SMC110	AW20-N02E-Z-B



MINI REGULATOR

SMC PNEUMATICS



- **PORTS:** 1/4" NPT
- **OPERATING PSI:** 0 - 145
- **TEMP. RANGE:** 23° to 140°F (with no freezing)
- **FILTER ELEMENT:** 5 micron
- Low profile embedded gauge
- SMC 20 series filter/regulator with gauge

PRICE	PART #	MFG. PART #	FLOW TYPE
\$18.37	SMC105	AR20-N02E-Z-B	Left to Right
\$23.63	SMC100	AR20-N02E-RZ-B	Reverse Flow - Right to Left



ELECTRO-PNEUMATIC 2000 SERIES AIR REGULATOR

SMC PNEUMATICS

- Air pressure regulator that uses an electrical signal to control the pressure level
- **PORTS:** 3/8" NPT
- **OPERATING PSI:** 0.72 - 130
- **TEMP. RANGE:** 32° to 122°F (with no freezing)
- **VOLTAGE:** 24 VDC

\$367.65	SMC250
-----------------	---------------



COMPACT FRL SPACER

SMC PNEUMATICS

- Compact spacer with bracket reduces assembly space
- Easy maintenance
- Attach FRL's using screws
- O-ring prevents leaks

\$7.16	SMCP105
---------------	----------------



1/4" MODULAR COMBO UNIT

SMC PNEUMATICS



- **TEMP. RANGE:** 23° to 140°F (with no freezing)
- **PORTS:** 1/4" NPT
- Push drain metal bowl with bowl guard
- Compact, space-saving unit

PRICE	PART #	MFG. PART #
\$84.94	SMC115	AC20-N02E-ZZ-B



WATER SEPARATOR

SMC PNEUMATICS



- The AMG series water separator is installed on the air pressure line to remove water drops in the compressed air. It is suitable for use in cases where "water must be removed, but the air does not have to be as dry as when an air dryer is used" or "an air dryer cannot be used because an electric power supply is not available". Through the adoption of an element that is used exclusively for removing water drops and the provision of ample housing interior space, a 99% water removal rate has been achieved.
- Auto drain • Mounting bracket

PRICE	PART #	SIZE	MFG PART #
\$88.28	SMC125	1/4"	AMG250C-N02BC
\$127.50	SMC130	3/8"	AMG350C-N03BC
\$146.67	SMC135	1/2"	AMG450C-N04BC



ITV SERIES REGULATOR CABLE

SMC PNEUMATICS

- Used to connect ITV Series Electro-Pneumatic Regulators to a power source
- Compatible with ITV1000, ITV2000, ITV3000
- 3 Meters (9.84252 Feet)
- Angle: Right
- Design: 4 Wire
- Connector Style: M12

\$21.72	SMC255
----------------	---------------



1/2" MODULAR COMBO UNIT

SMC PNEUMATICS



- **TEMP. RANGE:** 23° to 140°F (with no freezing)
- **FILTER:** 5 Micron
- **PORTS:** 1/2" NPT
- Push drain polycarbonate bowl with bowl guard
- SMC 40 series filter/regulator/lubricator with embedded gauge

PRICE	PART #	MFG. PART #
\$126.86	SMC120	AC40-N04E-Z-B

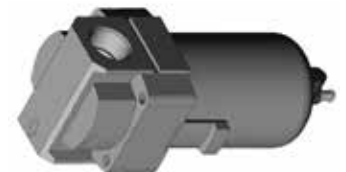

AIR FILTER

SMC PNEUMATICS

- An AF series air filter that combines the element and bowl in one piece
- **PORTS:** 3/8" NPT
- **OPERATING PSI:** 145
- **TEMP. RANGE:** 23° to 140°F (with no freezing)

\$26.04	SMC251	One Piece Air Filter
\$47.22	SMC252	Mist Separator and Air Filter

PUMP ACCESSORIES

PRESSURE SWITCHES & TANKS

**NO
MANUAL
SWITCH**



**WITH
MANUAL
SWITCH**



PRESSURE SWITCHES SQUARE D



- For low-pressure pumps, tire cleaner, presoak, and foam brush systems
- For both air and liquid
- PSI: On-30 Off-50

\$28.02	ST0320	NO Manual Switch
\$33.85	ST0320-M	Manual Switch Included
\$38.81	ST0322	WITH Manual Switch
\$33.85	ST0322-M	Manual Switch Included



2 GALLON EXPANSION TANK FLEXICON INDUSTRIES



- **SIZE:** 2 Gallons
- **DRAW:** 1 Gallon
- **TANK CAPACITY:** 1 Gallon Liquid
- **INLET:** 3/4" MIP

\$72.23 **TAWX101**



5 GALLON EXPANSION TANK FLEXICON INDUSTRIES



- **SIZE:** 5 Gallons
- **DRAW:** 2 1/2 Gallon
- **TANK CAPACITY:** 2 1/2 Gallon Liquid
- **INLET:** 3/4" MIP

\$85.98 **TAWX102**



PRESSURE SWITCH FURNAS **Furnas**

- For water - liquids only
- Adjustable differential
- 2 pole contact
- PSI Range: 30-50

PHASE	120V	240V	600V
1	1 1/2	2	-
3	-	3	1

\$70.20 **ST0323**



PRESSURE SWITCH FURNAS **Furnas**

- Reverse action - liquids only
- 2 pole contact
- Cut in: 50 PSI - Cut out: 30 PSI
- 1/4" F

PHASE	120V	240V	600V
1	2	3	-
3	-	5	1

\$80.64 **ST0325**



We carry a full selection of pump accessories, including valves, pressure gauges, pressure switches, belts, motors and more. Our accessories consist of the highest-quality components, manufactured to provide the best service and durability.

Visit KLEENRITE.COM for great deals and low prices on all your pump accessories and other car wash related items to keep your business running! Choose from a large, constantly growing selection of pumps and pump accessories for any application.

PUMP ACCESSORIES

STRAINERS, DRAINS, & DRYERS



MECHANICAL CONDENSATE DRAINS

COILHOSE PNEUMATICS



- **DIMENSIONS:** 5 3/4"H x 2 1/8" Diameter
- **BOWL VOLUME:** 3.8 oz.
- MAXIMUM SUPPLY PRESSURE**
- **PLASTIC BOWL:** 150 PSI
- **METAL BOWL:** 250 PSI
- MAXIMUM OPERATING TEMPERATURE**
- **PLASTIC BOWL:** 120 °F
- **METAL BOWL:** 250 °F
- MATERIALS**
- **BODY:** Aluminum
- **BOWL:** Polycarbonate plastic with high-impact guard OR die-cast zinc
- **FLOAT:** Plastic and stainless steel internals

\$69.29	REA8514	With polycarbonate bowl
\$77.77	REA8514M	With metal bowl



DESICCANT AIR DRYERS

COILHOSE PNEUMATICS



- **PRESSURE DROP:** Less than 1 PSI
- **MAX. FLOW CAPACITY:** 10 SCFM
- **MAX. PRESSURE:** 150 PSI
- **MAX. TEMP:** 125 ° F
- **BODY MATERIAL:** Zinc die-cast
- **BOWL MATERIAL:** Polycarbonate
- **BOWL GUARD:** Steel
- **DIMENSIONS:** 12.25"W x 4.5"W

\$256.45	REA8422	1/4" Port
\$256.45	REA8423	3/8" Port
\$256.45	REA8424	1/2" Port
\$41.92	REA8422-GEL	Desiccant Gel Refill



EXTRACTOR/DRYER

FLOJET AIR DRYERS



- Developed for air-driven pumps, valves or any other air-driven equipment. Removes condensation, oil and contaminants from compressor air supply.
- Easy to install in-line
- Perform maintenance without removal
- Weep drain for condensate removal
- 2 Stage filter medium
- **MICRON RATING:** 5 Micron Rating
- **PRESSURE:** 250 PSI
- **HOUSING:** Lightweight, rust-proof aluminum

\$141.48	FP520B
-----------------	---------------



HIGH PRESSURE STRAINER

SPRAYING SYSTEMS CO



- **SIZE:** 1/4" M X F
- **MAX PRESSURE:** 4000 PSI
- **SCREEN:** Stainless steel 100 mesh
- **BODY MATERIAL:** Brass
- Helps keep debris from damaging or clogging rotating spray nozzles

\$38.32	STR36387
----------------	-----------------



STRAINERS

SPRAYING SYSTEMS CO STRAINERS



- Polypropylene bowl and head for corrosion and chemical resistance
- Stainless steel screen
- Ethylene propylene gasket
- Clear nylon bowl is UV resistant

1/2" STRAINERS

SPRAYING SYSTEMS CO® STRAINERS

PRICE	PART #	BOWL	MESH
\$15.19	STR0830	Nylon (Clear)	30
\$15.19	STR0850	Nylon (Clear)	50
\$12.08	STR0870	Polypropylene	100
\$15.19	STR0880	Nylon (Clear)	80
\$12.24	STR0880WB	Nylon (White)	80

3/4" STRAINERS

SPRAYING SYSTEMS CO® STRAINERS

PRICE	PART #	BOWL	MESH
\$15.19	STR12100	Nylon (Clear)	100
\$14.61	STR1250	Nylon (Clear)	50
\$15.19	STR1280	Nylon (Clear)	80
\$15.19	STR1230	Nylon (Clear)	30

STRAINER PARTS

SPRAYING SYSTEMS CO® STRAINERS

PRICE	PART #	PART
\$6.26	STR122CB	Clear Nylon Bowl
\$4.87	STR122CB-P	Polypropylene Bowl
\$4.58	STR122SCR	80 Mesh Screen
\$4.17	STR1230S	30 Mesh Screen
\$8.95	STR1680S	80 Mesh Screen
\$3.56	STR16800	O-Ring
\$3.43	STRG122	Gasket for 1/2" and 3/4"



CLEAR BOWL STRAINERS

GENERAL PUMP STRAINERS



- **MAX. PRESSURE @ 70°F:** 150 PSI
- **MAX. PRESSURE @ 125°F:** 125 PSI
- **O-RING MATERIAL:** EPDM
- **BODY MATERIAL:** Nylon
- **BOWL MATERIAL:** Polycarbonate
- **SCREEN:** Stainless steel 50 mesh

PRICE	PART #	INLET/OUTLET	PRICE	PART #	INLET/OUTLET
\$7.87	GPDF05050	1/2"	\$23.42	GPDF12550	1-1/4"
\$8.49	GPDF07550	3/4"	\$25.30	GPDF15050	1-1/2"
\$20.54	GPDF10050	1"			

PUMP ACCESSORIES

STRAINERS

CLEARBOWL INLINE STRAINERS

THE SPECIALTY MFG. CO.

THE SPECIALTY MFG. CO.
Custom to Our Specialty

- "T" Style Inline Strainers have large filter areas for better filtration of liquids. Strainer components are easily cleaned or replaced without removing entire strainer. Bowls and tops have heavy buttress threads to prevent cross threading.



SMALL CLEARBOWL INLINE STRAINERS

THE SPECIALTY MFG. CO.

PRICE	PART #	SIZE	MESH
\$8.17	PU07101	3/8" M x M	50
\$8.17	PU07102	1/2" M x M	50
\$8.33	PU07103	1/4" M x M	50
\$8.17	PU071034	1/4" M x M	80



LARGE CLEARBOWL INLINE STRAINERS

THE SPECIALTY MFG. CO.

PRICE	PART #	SIZE	MESH
\$16.08	PU07104	1/2" F x F	80
\$12.78	PU071044FF	1/2" F x F	50
\$16.08	PU07105	3/4" F x F	80
\$16.08	PU071054	3/4" F x F	50
\$27.55	PU07106	1" F x F	50
\$29.65	PU0710680	1" F x F	80
\$28.42	PU07107	1 1/4" F x F	50
\$36.79	PU07108	1 1/2" F x F	50

CLEARBOWL INLINE STRAINER PARTS

THE SPECIALTY MFG. CO.

THE SPECIALTY MFG. CO.
Custom to Our Specialty

PRICE	PART #	DESCRIPTION	SIZE
\$8.39	PU07103B	Gasket	For 1/4" M x M
\$0.76	PU07103G	Gasket	For 1/4", 3/8", 1/2" M x M
\$3.73	PU07103S40	Screen	1/4", 3/8", 1/2" 50 mesh
\$10.66	PU071045B	Clear bowl only	For 1/2" & 3/4"
\$0.91	PU07105G	Gasket	For 1/2" & 3/4"
\$6.10	PU07105S40	Screen	1/2" & 3/4" 50 mesh

PRICE	PART #	DESCRIPTION	SIZE
\$18.21	PU07106B	Clear bowl only	For 1"
\$1.46	PU07106G	Gasket	For 1" & 1 1/4"
\$6.10	PU07105S80	Screen	1/2" & 3/4" 80 mesh
\$7.23	PU07106S40	Screen	1" for 50 mesh
\$11.20	PU07106S80	Screen	1" for 80 mesh

40 MESH BASKET STRAINERS

THE SPECIALTY MFG. CO.

THE SPECIALTY MFG. CO.
Custom to Our Specialty

PRICE	PART #	SIZE
\$3.51	IN003	1/8" M or 3/8" Barb
\$3.99	IN010	1/4" MIP or 1/2" Barb
\$4.53	IN015	3/8" M or 5/8" Barb
\$5.11	IN020	1/2" M or 3/4" Barb
\$5.11	IN021	1/2" M or 3/4" Barb 80 mesh
\$5.47	IN025	3/4" M or 1" Barb
\$6.98	IN030	1" M or 1 1/4" Barb
\$8.47	IN035	1 1/2" MIP

Y-TYPE LINE STRAINERS

DEMA ENGINEERING

DEMA

- SCREEN: Stainless steel
- MAX. PRESSURE @ 150°F: 300 PSI
- MAX. PRESSURE @ 375°F: 150 PSI
- BODY: Brass or cast bronze

PRICE	PART #	DESCRIPTION
\$25.68	INDS2B40	1/4" 40 Mesh
\$25.68	INDS2B80	1/4" 80 Mesh
\$25.68	INDS3B40	3/8" 40 Mesh
\$25.68	INDS3B80	3/8" 80 Mesh
\$30.28	INDS4B40	1/2" 40 Mesh
\$30.28	INDS4B80	1/2" 80 Mesh
\$59.79	INDS6B40	3/4" 40 Mesh
\$59.79	INDS6B80	3/4" 80 Mesh
\$81.75	INDS10B40	1" 40 Mesh
\$7.22	INDS3P	3/8" Plastic 100 Mesh

California Proposition 65



Y BRASS INTAKE FILTER

J.E. ADAMS

J.E. ADAMS

- SCREEN: 50 mesh stainless steel
- MAX. PRESSURE: 300 PSI
- BODY: Brass
- PORTS: 1/2" F

\$16.27 IN2111P

REPLACEMENT CAP & SCREEN FOR Y-TYPE LINE STRAINERS

DEMA ENGINEERING

DEMA

PRICE	PART #	DESCRIPTION
\$8.31	INDPS21	1/4" 40 Mesh
\$8.31	INDPS22	1/4" 80 Mesh
\$5.27	INDPS31	3/8" 40 Mesh
\$8.31	INDPS32	3/8" 80 Mesh
\$9.28	INDPS41	1/2" 40 Mesh
\$9.28	INDPS42	1/2" 80 Mesh
\$23.91	INDPS61	3/4" 40 Mesh
\$23.91	INDPS62	3/4" 80 Mesh
\$29.45	INDPS101	1" 40 Mesh

California Proposition 65

PUMP ACCESSORIES



FLOW SWITCHES & PRESSURE GAUGES

YFL7 SWITCH - 3/8" FLOW SWITCH

GENERAL PUMP FLOW SWITCHES

- **MAX. OP. PRESSURE:** 5100 PSI
- **ACTIVATION FLOW RATE:** Horizontal 1.5 GPM
- **MAX. VOLTS:** 250V
- **MAX. PRESSURE:** 5650 PSI
- **VERTICAL:** 2.1 GPM
- **MAX. AMPS:** 1 amp
- **MAX. FLOW:** 8.0 GPM
- **MAX. TEMP:** 180 °F

\$66.03 ST0392

FLOW SWITCH - 3/8" FLOW SWITCH

GENERAL PUMP FLOW SWITCHES

- **MAX. VOLUME:** 7.5 GPM
- **MAX. VOLTAGE:** 250V
- **MIN. FLOW REQUIRED FOR ACTIVATION:** 1 gallon
- **MATERIALS:** Brass, stainless steel, Buna-N
- **MAX. AMPS:** 1 Amp - non-inductive loads
- **OPERATING TEMPERATURE RANGE:** Up to 175 °F

\$45.75 ST0390

TMT FLOW SWITCH W/ STAINLESS STEEL SHUTTLE INLINE FLOW

GENERAL PUMP FLOW SWITCHES

STANDARD FEATURES:

- Micro-switch technology eliminates reed switch
- Activates with 1.5 GPM flow
- Minimal pressure drop up to 12 GPM flow
- Can be mounted in any position
- Stainless steel shuttle
- **MAXIMUM OPERATING PRESSURE:** 5000 PSI
- **MINIMUM FLOW REQUIRED FOR ACTIVATION:** 1.5 GPM @ 50 PSI
- **MAXIMUM OPERATING FLOW:** 12.0 GPM
- **OPERATING TEMPERATURE RANGE:** 40 - 180 °F

\$42.31 GPP100975

TMT FLOW SWITCH

GENERAL PUMP FLOW SWITCHES

- Tri-magnet flow switch is available with (GPP100879) or without pilot feature (GPP100904)

STANDARD FEATURES:

- Micro-switch technology eliminates reed switch
- Activates with .5 GPM flow
- Minimal pressure drop up to 12 GPM flow
- Mount in vertical position
- **MAXIMUM OPERATING PRESSURE:** 4000 PSI
- **MINIMUM FLOW REQUIRED FOR ACTIVATION:** 0.5 GPM @ 50 PSI
- **MAXIMUM OPERATING FLOW:** 12.0 GPM
- **OPERATING TEMPERATURE RANGE:** 40 - 180 °F

\$101.73 GPP100904 WITHOUT Pilot Feature

\$115.60 GPP100879 WITH Pilot Feature



LIQUID FILLED 1/4" BOTTOM MOUNT

- 2 1/2" face diameter
- 304 SS satin finish

PART #	PSI
GAL60B	0-60
GAL100B	0-100
GAL200B	0-200
GAL300B	0-300
GAL400B	0-400
GAL1000B	0-1000
GAL1500B	0-1500
GAL2000B	0-2000
GAL3000B	0-3000
GAL5000B	0-5000
GAL6000B	0-6000
GAL10000B	0-10000

\$14.11



LIQUID FILLED 1/4" REAR MOUNT

- 2 1/2" face diameter
- 304 SS satin finish

PART #	PSI
GAL100R	0-100
GAL200R	0-200
GAL300R	0-300
GAL1000R	0-1000
GAL2000R	0-2000
GAL3000R	0-3000
GAL5000R	0-5000

\$15.00



New!



NON-LIQUID FILLED 1/4" BOTTOM MOUNT

- 2" face diameter

PART #	PSI
GA100B	0-100
GA200B	0-200
GA300B	0-300

\$5.05



NON-LIQUID FILLED 1/4" REAR MOUNT

- 2" face diameter

PART #	PSI
GA100R	0-100
GA200R	0-200
GA300R	0-300

\$5.38



MINI GAUGE

- 1/8" MPT rear mount
- 1 1/2" diameter

PART #	PSI
GAM160	0-160

\$6.35



HOUR METER

- Panel mount
- 24V

PART #
GS18165

\$80.96



PUMP ACCESSORIES

MOTORS



BALDOR MOTORS



- Other sizes available upon request
- Electric motor efficiency standards: As of December 19, 2010, all motors on this page are now compliant with the NEMA Premium® energy efficiency levels

PRICE	PART #	HP	PHASE	ENCLOSURE	FRAME	RPM	
\$1,055.54	MBEM3211T	3	3PH	ODP	182T	1760	
\$884.48	MBEM3218T	5	3PH		184T	1760	
\$1,157.01	MBCEM3211T (C-FACE)	3	3PH		182TC	1765	
\$1,259.09	MBCEM3218T (C-FACE)	5	3PH		184TC	1750	
\$770.72	MBL1408T	3	1PH		184T	1725	
\$1,009.26	MBL1410T	5	1PH		184T	1725	
\$1,530.36	MBCL1410TM (C-FACE)	3	1PH		184TC	1725	
\$1,084.05	MBCEM3611T (C-FACE)	5	1PH		184TC	1760	
\$1,095.10	MBCEM3615T (C-FACE)	5	3PH		TEFC	184TC	1750
\$1,660.26	MBCEM3710T (C-FACE)	7.5	3PH			213TC	1770
\$2,018.81	MBEM2513T	1.5	3PH	ODP	254T	1765	
\$1,501.29	MBEM3311T	7.5	3PH		213T	1770	

PRICE	PART #	HP	PHASE	ENCLOS.	FRAME	RPM
\$842.94	MBEM3611T	5	3PH	TEFC	182T	
\$915.95	MBEM3615T	5	3PH		184T	1750
\$1,385.00	MBEM3711T	10	3PH		215T	3490
\$1,237.02	* PU8026M	3	1PH	Direct Drive	-	-
\$1,290.06	* PU8027M	3	3PH		-	-
\$844.73	MBCEM3546	1	3PH	TEFC	56C	1760
\$847.88	MBEM3157T	2	3PH	OPSB	145T	1750
\$1,408.75	MBEJMM3212T	5	3PH	OPSB	182JM	3450
\$656.02	MBVEL11304	0.5	1PH	OPEN	56C	1725

* HOLLOW SHAFT FOR CAT PUMPS



MARATHON WASH DOWN MOTORS

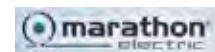

- Double sealed ball bearings
- 303 Stainless steel shaft with spring loaded contact seals in each endshield
- Encapsulated electronic starting switch is impervious to moisture
- Cast oversized conduit box with high-temperature nitrile gaskets and threaded entrance
- Internal corrosion-resistant coatings on frame, base, endshields, rotor and stator
- Stainless steel conduit box cover, nameplate, fan guard (TEFC) and hardware
- Plugged drain holes in each endshield for all angle mounting
- Capacitor start induction run design for high starting torque unless otherwise noted
- Class F insulation, 1.15 Service Factor, and UL Recognized and CSA Certified

\$868.54	MWD450	1/3 HP, 3600 RPM, 56C with base
----------	--------	---------------------------------

New!



ELECTRIC WEG MOTOR



- Has an IC411 enclosed fan-cooled enclosure to keep it from overheating
- **OUTPUT:** 7.5 HP | 15HP
- **RATED SPEED:** 1765 RPM | 1770 RPM
- **FREQUENCY:** 60 Hz
- **RATED VOLTAGE:** 230/460 V

\$807.85	WEG11723875	For: Sonny's Prep Gun Station
\$1,273.49	WEG11611480	For: Sonny's H25 Pump Station



FRAGRAMATICS TURBO MOTOR



- 120V, 2-stage vacuum motor
- 1500 hour motor brush life
- Dimensions: 10" x 10" x 10"

\$88.71	FMVAC820
---------	----------



CONTACTORS

HARTLAND CONTROLS



\$34.04	MS0100	2 Pole Contactor	24V
\$34.04	MS0105		120V
\$43.69	MS0110	3 Pole Contactor	24V
\$43.69	MS0115		120V



ADJUSTABLE OVERLOAD PROTECTOR

ALLEN/BRADLEY MOTOR STARTERS

- Used with 3HP/5HP self serve motors

\$90.67	MS18968
---------	---------



CONTACTOR

ALLEN/BRADLEY MOTOR STARTERS

- Used with 3HP/5HP self serve motors

\$76.80	MS18967
---------	---------

PUMP ACCESSORIES

HYDRAULIC FLUID



KLEEN & GREEN WATER-BASED HYDRAULIC FLUID

- Biodegradable
- No special handling
- Usually does not require special waste disposal
- Does not require hazardous storage
- Usually no exposure hazards (some individuals may have adverse skin reactions)
- Compatible with existing standard hydraulic components
- Prolonged high heat does not produce varnish or sludge
- Clean up with soap & water
- Fire-resistant

\$91.08	KNG5	5 Gallon
\$942.19	KNG55	55 Gallon



AW32 HYDRAULIC FLUID

- Premium A/W Hydraulic Oils are superior anti-wear hydraulic and circulating fluids specially formulated with high-quality base stocks and improved thermally stable additives. These oils offer outstanding resistance to sludge formation, are chemically stable, and exhibit excellent anti-wear protection.

\$101.33	HF5	5 Gallon
\$843.75	HF55	55 Gallon

V-BELTS

V-BELTS CONTINENTAL



PRICE	PART #	PITCH DIA.	O.D.
\$10.04	BLOB30	30" P.D.	33"
\$10.28	BLOB31	31" P.D.	34"
\$10.43	BLOB32	32" P.D.	35"
\$10.65	BLOB33	33" P.D.	36"
\$11.19	BLOB34	34" P.D.	37"
\$11.06	BLOB35	35" P.D.	38"
\$11.39	BLOB36	36" P.D.	39"

PRICE	PART #	PITCH DIA.	O.D.
\$11.82	BLOB37	37" P.D.	40"
\$12.19	BLOB38	38" P.D.	41"
\$12.43	BLOB39	39" P.D.	42"
\$12.73	BLOB40	40" P.D.	43"
\$12.98	BLOB41	41" P.D.	44"
\$13.27	BLOB42	42" P.D.	45"
\$13.55	BLOB43	43" P.D.	46"

PRICE	PART #	PITCH DIA.	O.D.
\$13.83	BLOB44	44" P.D.	47"
\$14.11	BLOB45	45" P.D.	48"
\$14.38	BLOB46	46" P.D.	49"
\$14.57	BLOB47	47" P.D.	50"
\$14.84	BLOB48	48" P.D.	51"
\$15.03	BLOB49	49" P.D.	52"
\$15.26	BLOB50	50" P.D.	53"

V-BELTS BDH BELTS



- Composite Links offer a smooth transition from sheave to sheave.
- Manufactured with premium micro-milled urethanes and resins with ultra low VOCs
- Compatible with standard and SP sheaves. • Made in the USA

PRICE	PART #	DESCRIPTION
\$62.16	BL321830S	6.5" "A" Section - 1/2" Duro Drive Belts
\$70.27	BL321850S	6.5" "B" Section - 5/8" Duro Drive Belts
\$89.19	BL320130	10" "A" Section - 1/2" Duro Drive Belts
\$101.35	BL320150	10" "B" Section - 5/8" Duro Drive Belts
\$222.97	BL322530	25" "A" Section - 1/2" Duro Drive Belts

PRICE	PART #	DESCRIPTION
\$253.38	BL322550	25" "B" Section - 5/8" Duro Drive Belts
\$445.95	BL325030	50" "A" Section - 1/2" Duro Drive Belts
\$506.76	BL325050	50" "B" Section - 5/8" Duro Drive Belts
\$844.59	BL321030	100" "A" Section - 1/2" Duro Drive Belts
\$1,013.51	BL321050	100" "B" Section - 5/8" Duro Drive Belts

BUSHINGS & CAST IRON PULLEYS



H BUSHINGS REPLACEMENT PARTS

PRICE	PART #	SHAFT	PRICE	PART #	SHAFT
\$13.06	PL0010	3/4"	\$19.53	PU30942	16.5MM
\$13.08	PL0015	7/8"	\$16.41	PU01065	18MM
\$13.06	PL0020	1"	\$15.66	PU30945	20MM
\$13.06	PL0025	1 1/8"	\$13.06	PU01056	22MM
\$13.06	PL0030	1 3/8"	\$15.66	PU33000	24MM
			\$18.25	PU30234	25MM
			\$13.06	PU30059	30MM
			\$13.06	GPPBH35	35MM



SINGLE GROOVE CAST IRON PULLEYS

PRICE	PART #	O.D.	PRICE	PART #	O.D.
\$31.00	PL0100	3.15	\$37.80	PL0128	5.45
\$32.94	PL0105	3.35	\$40.26	PL0129	5.95
\$32.94	PL0110	3.55	\$42.96	PL0130	6.25
\$33.24	PL0115	3.75	\$44.20	PL0131	6.45
\$33.24	PL0120	3.95	\$45.64	PL0132	6.75
\$33.94	PL0122	4.25	\$47.84	PL0133	6.95
\$34.84	PL0123	4.45	\$49.86	PL0134	7.25
\$35.60	PL0124	4.75	\$51.44	PL0135	7.75
\$36.26	PL0126	4.95	\$78.06	PL0139	9.75
\$37.10	PL0127	5.25			



DOUBLE GROOVE CAST IRON PULLEYS

PRICE	PART #	O.D.	PRICE	PART #	O.D.
\$50.86	PL0140	3.35	\$70.76	PL0180	5.45
\$51.10	PL0145	3.55	\$72.34	PL0181	5.75
\$52.20	PL0150	3.75	\$73.34	PL0182	5.95
\$52.66	PL0155	3.95	\$79.06	PL0183	6.25
\$48.68	PL0160	4.25	\$80.40	PL0185	6.45
\$59.64	PL0165	4.45	\$82.56	PL0190	6.75
\$60.66	PL0170	4.75	\$96.04	PL0195	7.75
\$62.24	PL0174	4.95	\$97.66	PL0197	8.75
\$69.56	PL0175	5.25	\$102.12	PU30206	9.75

CHANGERS & COUNTERS



AMERICAN CHANGER

Kleen-Rite now offers financing through QuickSpark Financial. Visit our website for full details! With financing we give you the power to make much needed equipment upgrades without breaking your budget.



**AMC1005
PYRAMID VALIDATOR**
AMERICAN CHANGER - REAR LOAD

AMC1005



**AMC2005
PYRAMID VALIDATOR**
AMERICAN CHANGER - REAR LOAD

• 5,200 quarters/tokens total

AMC2005 Non-Returnable

**AMC2225
PYRAMID VALIDATOR**
AMERICAN CHANGER - REAR LOAD

• 11,200 quarters/tokens total

AMC2225 Non-Returnable

If replacement, specify width

**AMC2221
PYRAMID VALIDATOR**
AMERICAN CHANGER - REAR LOAD

• 5,200 quarters/tokens total

AMC2221

**AMC1005-M
CPI TALOS VALIDATOR
(500 NOTE)**
AMERICAN CHANGER - REAR LOAD

AMC1005-M



**AMC2005-M
CPI TALOS VALIDATOR
(500 NOTE)**
AMERICAN CHANGER - REAR LOAD

AMC2005-M

**AMC2225-M
CPI TALOS VALIDATOR
(500 NOTE)**
AMERICAN CHANGER - REAR LOAD

AMC2225-M

If replacement, specify width

**AMC2221-M
CPI TALOS VALIDATOR
(500 NOTE)**
AMERICAN CHANGER - REAR LOAD

AMC2221-M

THESE MODELS CAN BE UPGRADED TO INCLUDE THE OPTIONAL REMOTE ACCESS BOARD

MODELS	AC1005	AC2005	AC2225	AC2221
STANDARD CAPACITY	2,600 quarters/tokens	2,600 quarters/tokens per hopper	5,600 quarters/tokens per hopper	2,600 quarters/tokens per hopper
PAY OUT	Hopper loaded, quarters or tokens (20mm - 30mm)	2 hoppers & optional .25 token acceptor	2 hoppers, 2 validators, 2 logic boards	2 hoppers, 2 validators, 2 boards, 2 power supplies
SUSAN B. ANTHONY/\$1	Yes	Yes	Yes	Yes, any 2 coin payout
VALIDATOR ACCEPTANCE	\$1, \$5, \$10, \$20	\$1, \$5, \$10, \$20	\$1, \$5, \$10, \$20 (2 Validators)	\$1, \$5, \$10, \$20 (2 validators)
HOLE DIMENSIONS	8½" W x 26" H x 13" D	13½" W x 26" H x 13½" D	19¼" W x 29" H x 14" D	17¼" W x 26" H x 13" D
FACEPLATE DIMENSIONS	12½" W x 30" H	17½" W x 30" H	23" W x 33" H	21" W x 30" H

CHANGERS & COUNTERS



AMERICAN CHANGER



FRONT LOAD CHANGERS - STANDARD WITH PYRAMID VALIDATORS

AMERICAN CHANGER

MODELS	AMC1001	AMC2001*	AMC1002*	AMC2002*
HOPPER CAPACITY	2,600 Qrts/Tkn or 1,800 \$1 Coins	5,200 Qrts/Tkn or 3,200 \$1 coins	2,600 Qrts/Tkn or 1,600 \$1 Coins	5,200 Qrts/Tkn or 3,200 \$1 Coins
HOPPERS	1	2	1	2
ACCEPTS	\$1, \$5, \$10, \$20	\$1, \$5, \$10, \$20	\$1, \$5, \$10, \$20	\$1, \$5, \$10, \$20
DIMENSIONS	8½" W x 26" H x 13" D	13½" W x 26" H x 13" D	10½" W x 26" H x 13" D	15½" W x 26" H x 13½" D
OPTIONAL VALIDATORS	AMC1001-M CPI Talos Validator (500 Note)	AMC2001-M* CPI Talos Validator (500 Note)	AMC1002-M* CPI Talos Validator (500 Note)	AMC2002-M* CPI Talos Validator (500 Note)
		* Non-Returnable	* Non-Returnable	* Non-Returnable



AMC2207 - CASH, COIN & CREDIT CARD "TOKEN" DISPENSER

AMERICAN CHANGER

PRODUCT FEATURES:

- Credit card reader accepts: Visa, Master Card, and American Express
- Pyramid validator accepts: \$1, \$5, \$10, \$20
- Stacker capacity: 500 bills
- 2 Hoppers: Total capacity up to 11,200 tokens
- \$1 coin/quarter acceptor
- UNLIMITED bonus payouts
- Four programmable selections
- LCD screen
- Receipt and audit printer
- Token range: Diameter: ¾" to 1½" - Thickness: .049" to .098"
- Operates over a cellular or optional IP/Ethernet connection

DIMENSIONS:

- 21" W x 26½" H x 14" D
- Weight: 125 lbs.
- Requires rough-in opening of ½" all around

STAINLESS STEEL FACE PLATE:

- 25" W x 30½" H
- Weight: 25 lbs.

AMC2207

YOU CAN ADD CRYPTOPAY TO THIS MODEL!



AMC7715 - REAR LOAD BILL TO BILL DISPENSER

AMERICAN CHANGER

PRODUCT FEATURES:

- Single bill dispenser
- Dispenser capacity: (1) 700-note cartridge
- High security design
- Stainless steel face plate
- Pyramid validator Accepts: \$1, \$5, \$10, \$20
- Stacker Capacity: 500 Bills
- LCD digital display
- "Out of service" light
- Decal provided for multiple payouts

DIMENSIONS:

- 19¼"W x 26"H x 18.10"D
- Weight: 140 lbs.
- Stainless steel face plate: 23¼" W x 30" H

OPTIONS:

- CPI Talos T702-U10M Validator
- Bill Accepts: \$50, \$100
- 700 note stacker
- High security T-handle
- Medeco lock & key
- Remote Access Board

AMC7715

CHANGERS & COUNTERS



AMERICAN CHANGER



AMC8002 FRONT LOAD PLATINUM SERIES

AMERICAN CHANGER

PRODUCT FEATURES:

- Can dispense one of the following: quarters, tokens or \$1 coins
- Hopper capacity: 2,600 quarters/tokens, 2,000 \$1 coins
- Token range: Diameter: 3/4" to 1 1/8", Thickness: .049" to .098"
- Pyramid validator accepts: \$1, \$5, \$10, \$20
- Welded stainless steel construction
- (2) High security Medeco locks
- Stacker capacity: 500 bills

DIMENSIONS:

- 10 1/2" W x 26" H x 13 1/4" D
- Weight: 84 lbs.

OPTIONS:

- Stainless steel console base 10 1/2" W x 32" H x 13 1/4" D
- High security pedestal base 20" W x 26 3/4" H x 15 3/4" D
- Micro-Coin coin acceptor
- CPI Talos validator (\$1, \$5, \$10, \$20)
- IDX electronic coin acceptor
- Audit printer
- Heater
- Remote Access Board Kit
- NAYAX Credit Card Reader

AMC8002

Non-Returnable



REPLACEMENT HOPPER

AMERICAN CHANGER

PART #	DESCRIPTION
AC1047.5-A-HPH	AC1047.5-A-HPH Hopper Kit – Front Load, Rear Load Replaces AMCP1047-SFL & AMCP1047-SRL

AMERICAN CHANGER PARTS

PART #	TYPE	DESCRIPTION
AMCP1065.3KIT	UNIVERSAL BOARD	Operates One Validator and Two Hoppers ***MUST SPECIFY MACHINE AND SERIAL NUMBER***
AMCP10671-24	SUPER UNIVERSAL BOARD	Can operate Credit Card, Two Validators and/or Two Hoppers AC7021 is the retrofit kit for 110 Validators
L00127 (AC1095)	MEDECO T-HANDLE LOCK	1 Lock with 1 Key
AMCP5080-QSPIN	HIGH SECURITY	Fluted T-handle with anti-drill pins for theft protection
AMCP7076	AUDIT PRINTER	Call for more information



AMERICAN CHANGER PRICE STICKERS

AMERICAN CHANGER

PART #	DESCRIPTION
AMCSTICKERS-1	\$1 Bills Only Sticker
AMCSTICKERS-5	\$1, \$5, & \$10 Dollar Bills Sticker

CHANGERS & COUNTERS

CURRENCY VALIDATORS



BILL ACCEPTOR WITH FLEXSTACK

PAYCOMPLETE/COINCO

PayComplete **COINCO**

- Accepts: \$1 - \$20 bills, four-way insertion
- Cashbox size: FlexStack - cashbox holds 200-500 bills
- Communication Interface: MDB
- Quick release bezel speeds installation and maintenance
- Optical stringing protection
- Streamlined bill path and intelligent bill transport software reduce jam conditions providing highest in-service time
- Bezel type: Basic
- Voltage: 34VDC
- Mounting orientation: Upstack
- Superior water protection
- Attention grabbing impulse lights

\$387.84	VX63B45US00	Basic bezel
\$365.75	VX63M45US00	Basic metal bezel for added durability



CURRENCY VALIDATORS

PYRAMID TECHNOLOGIES



- 12VDC standard, with 24VAC, MDB, and 120VAC power supply options
- Numerous interfaces available - pinouts compatible with other manufacturers
- Accepts bills up to 72mm wide for foreign applications
- Automatic self-calibration, never requires user calibration
- Lighted arrows on bezel and bill entry area
- Simple setup with configuration card
- Free currency upgrades
- Dual-stage optical anti-stringing
- High security against fraudulent bills
- Push-button/LED on-board diagnostics

\$13.50	PT05AA0012	Wall Plug Adapter
\$70.50	PT02AA3005	Universal 500 Note Plastic Cashbox For Apex And Spectra Stackers
\$290.41	PTAPEX7400-DB4	No Mag Head: \$1 - \$20 - Down Stacker - 500 Bill - MDB Harness
\$292.26	PTAPEX7400-UB4	No Mag Head: \$1 - \$20 - Upstacker - 500 Bill - MDB Harness
\$292.26	PTAPEX7401-DB4	No Mag Head: \$1 - \$20 - Coinco Bezel - Downstacker - 500 Bill - MDB Harness
\$271.78	PTAPEX7401-UB4	No Mag Head: \$1 - \$20 - Coinco Bezel - Upstacker - 500 Plastic Bill - MDB Harness
\$292.26	PTAPEX7402-UB4	No Mag Head: \$1 - \$20 - VFM Bezel - Upstacker - 500 Plastic Bill - MDB Harness
\$336.22	PTAPEX7600-UB3	Mag Head: \$1 - \$100 - Upstacker - 500 Bill - 120 VAC
\$293.55	PTAPEX7401-UB3	Coinco Bezel: Upstacker - 500 Plastic Bill non-locking plastic cassette - 120 VAC



Did you know that Kleen-Rite creates The Kleen-Scene Magazine, its own car wash magazine, twice a year?

Our seasoned car wash technicians and professionals create a magazine that is chock full of useful tips, new item information, industry news and troubleshooting articles. This magazine is the only publication created by car wash professionals for car wash professionals.

To start receiving your free subscription to the Kleen-Scene Magazine, simply contact Kleen-Rite today and request to be on our mailing list.

Phone: 800-233-3873 | email: sales@kleen-ritecorp.com
or sign up on the web: kleenrite.com

CHANGERS & COUNTERS

CURRENCY VALIDATORS



CPI TALOS VALIDATORS



- Secures banknotes in speeds under 2.5 seconds
- Light Bar recognition system delivers best in class fraud detection
- Firmware updates via USB, increases update speed ten-fold
- Addresses new advances in banknote security
- Encrypted, secure, seamless updates
- 32-bit microprocessor with processing power to support enhanced features
- Enhanced security modes provide additional theft protection, early detection, and alarm triggering
- External error code access
- Replaces 2000 Series Bill Validators

CHANGES FROM 2000 SERIES:

- Light Bar recognition replaces Pellet Sensors
- No more dip switches
- Denomination acceptance programming w/banknote or coupon
- Increased banknote transport speed
- New bezel designs - VFM & Compact applications
- Single high security mode
- USB supported updates

SIMILARITIES WITH 2000 SERIES:

- All bezel design types are compatible, including cashless
- Retro bill magazine compatibility
- Reliable banknote transport and stacking mechanism performance
- Supports all OEM communication protocols and interface types
- Drop-in replacement for 2000 Series units
- Programming push button found behind the bill magazine

COINBOX VALIDATORS SPECIFY CHANGER AND MODEL

\$507.43	T6T1-U5E	T6T1-U5EUS	\$1 - \$20 110 VAC 500 Bill
\$434.99	T612-U3E	T612-U3E	\$1 - \$20 24 VAC 300 Bill
\$548.69	T631-D7E	T631-D7EUS	\$1 - \$20 110 VAC 700 Bill
\$537.07	T601-U7E	253100290P1	\$1 - \$20 110 VAC 700 Bill
\$496.53	T602-U5E	T602-U5E	\$1-\$20 24 VAC 500 Bill



\$507.43	T612-U5E	T612-U5E	\$1-\$20 24 VAC 500 Bill
\$496.46	T7T2-U5M	T7T2-U5M	\$1-\$20 24 VAC 500 Bill
\$496.46	T702-U5M	T702-U5M	\$1-\$20 24 VAC 500 Bill
\$545.20	T632-D7M	T632-D7M	\$1-\$20 24 VAC 700 Bill
\$507.43	T611-U5E	253100261P1	\$1-\$20 110 VAC 500 Bill

\$130.61	MARSBOX300	300 Note
\$172.98	MARSBOX500	500 Note
\$170.48	MARSBOX700	700 Note
\$116.64	MARSBOX1000	1000 Note

COINCO VALIDATORS - VANTAGE SERIES (DIRECT REPLACEMENT FOR MARS) VALIDATORS



- Accepts: \$1 - \$20 bills, four-way insertion
- Cashbox size: 400 bills
- Voltage: 110 VAC
- Communication Interface: MDB, Pulse, Parallel, Vend Serial
- Mounting orientation: Upstack
- Quick release bezel speeds installation and maintenance
- Streamlined bill path and intelligent bill transport software reduce jam conditions providing highest in-service time
- Superior water protection
- Optical stringing protection
- Attention grabbing impulse lights

\$474.32	VL61R44US00	110 Volt \$1-\$20 - 400 Note
\$474.32	VL61R45US00	110 Volt \$1-\$20 - Flex Stack

EVOLUTION COIN HOPPERS PAYCOMPLETE



- A belt-driven model designed for high speed and easy service
- Used by American Changer and Namco CyberTainment
- Black Bulgin plug connector (same as Money Controls MK4 connector) - pulse or on/off
- Connector can be easily changed from front to back
- Includes mounting plate
- Voltage 24VDC
- Operating Temperature: 32° to 158° F
- 1500 quarter capacity

\$219.28	EV100-011B	Bulgin Connector and Parallel Interface
\$217.32	EV100-001B	Cinch Connector, Parallel Interface

CHANGERS & COUNTERS



BILL CHANGERS & BREAKERS

"In \$20 Pay \$20
Thank You"



Bill Recycler

OR



Bill Validator

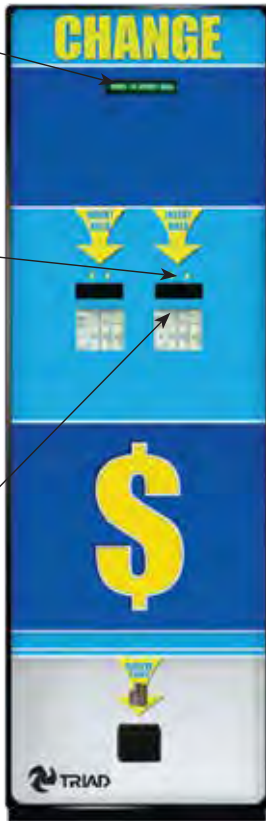

TRIAD 400A SERIES REAR LOAD BANKNOTE CHANGER WITH HIGH SECURITY CPI ACCEPTORS

TRIAD BILL CHANGERS & BREAKERS

STANDARD FEATURES:

- Two high-security CPI Talos validators accept \$1, \$5, \$10, \$20
- Only bill changer with a dual user feedback display
- Advanced 2-line display presents clear messages for user convenience and makes service simple
- Audit report displays bills accepted and coins/bills dispensed
- MDB compatible
- Each coin hopper has a capacity of 5,600 quarters or tokens
- Secure, heavy duty cabinet with 2 T-handle locks
- Provisioned for wall, table, or optional base mounting
- Power: 120 VAC, 60 Hz, 230W/4 AMP

OPTIONS:

- 2 or 4 CPI Talos bill recyclers (depending on model) with high security or high visibility bezels
- CPI Talos 700 note or 1000 note stackers available on rear load models
- Mounting base
- Token or custom graphics
- Coin acceptor
- Medeco Lock & Key
- Front load options available
- Steel faceplate
- Remote access board
- Drill Resistant T-Handle

CABINET DIMENSIONS:

- 38.62" H x 12.06" W x 18" D
- 130 lbs

FACE PLATE DIMENSIONS:

- 44.6" H x 18" W

KR PART #	FEATURES	# OF HOPPERS
TC400A-RL3	Rear load - 2 recyclers with high security bezels	2
TC400A-RL4	Rear load - 2 recyclers with high visibility bezels	2
TC400A-RL5	Rear load - 4 recyclers with high security bezels	4
TC400A-RL5HVB	Rear load - 4 recyclers with high visibility bezels	4

NOW UPDATED WITH AMERICAN CHANGER COMPONENTS!



TRIAD 500A SERIES REAR LOAD BILL BREAKER WITH HIGH SECURITY CPI ACCEPTORS

TRIAD BILL CHANGERS & BREAKERS

INCOMING BILLS:

- CPI Talos \$1, \$5, \$10, \$20 bill acceptor with 4-way acceptance direction

OUTGOING BILLS:

- Fujitsu F53 bill dispenser - 2,3 or 4 denominations
- Bill cassette capacities:
- Cassettes hold 500 new bills each

OUTGOING COINS/TOKENS:

- Coin hopper capacity: 1600 quarters/tokens (\$400)
- Optional coin hopper with extension capacity: 4,000 quarters/tokens (\$1,000)

DIMENSIONS:

- Cabinet dimensions: 38.62" H x 12.06" W x 18" D
- Face Plate Dimensions: 43" H x 18" W
- 160 lbs (500RL-2)
- 170 lbs (500RLC1-2)

POWER:

- 120 VAC, 60 Hz, 230W/3.5A

KR PART #	FEATURES	# OF HOPPERS
TC500A-RL2	2 Bill Denominations	0
TC500A-RLC1-2	2 Bill Denominations	1
TC500A-RL3	3 Bill Denominations	0
TC500A-RL4	4 Bill Denominations	0

TC500A-FL SERIES FRONT LOAD OPTIONS AVAILABLE!

NOW UPDATED WITH AMERICAN CHANGER COMPONENTS!

**MOUNTING BASE, CUSTOM EXTERIOR GRAPHICS, REMOTE AUDIT REPORTING & MORE AVAILABLE ON 500A-RL MODELS
CALL 800-233-3873 TO SPEAK WITH A SALES REPRESENTATIVE**

CHANGERS & COUNTERS



STANDARD CHANGE-MAKERS



SC CONVERSION KITS - US CURRENCY

STANDARD CHANGE-MAKERS

- Converts Systems 200/A, 500, 500E, & 600 to CPI Talos Bill Acceptor
- KIT INCLUDES:**
- SC Conversion Controller
 - CPI Talos Bill Acceptor
 - 24VDC Power Supply
 - Stainless External Bill Acceptor Plate
 - Internal Bill Acceptor Mount Bracket
 - Detailed Installation Instructions
 - Emailed Audit reports & Text Error Msgs (Requires On-site internet for this feature)

\$1,920.94	DCP4K01328-FI	SYSTEM 500, 500E & 600
\$1,954.62	DCP4K01465-FI	SYSTEM 200/A

BX1000RL-GM & BX2000RL-GM

STANDARD CHANGE-MAKERS

STANDARD FEATURES:

- Rear-Load, Dispensing Bills ONLY
- CPI Talos \$1- \$20 Bill Acceptor
- Single or dual Genmega dispenser
- EF Pus Module
- Cab. 19" W x 37.25" H x 20" D
- Powder Coated Plate 23" W x 41 1/4" H

OPTIONAL FEATURES:

- Upgrade to \$50 & \$100 Acceptance
- Patron Display w/Attendant Key Switch
- Stainless Steel Faceplate

\$6,320.83	DCBX1000RL-GM	1000 Bills
\$8,904.17	DCBX2000RL-GM	2000 Bills



BX1020RL/1030RL/1040RL BILL-TO-BILL EXCHANGERS

STANDARD CHANGE-MAKERS

STANDARD FEATURES:

- Rear-load
- Dispenses bills only
- CPI Talos \$1- \$20 Bill Acceptor
- 2,3, or 4 cassette Fujitsu F53 dispenser
- 500 bills per cassette
- EF Plus Module
- 17" W x 28" H x 18" D cabinet
- Powder coated plate: 21" W x 32" H

OPTIONAL FEATURES:

- Upgrade to a \$50 & \$100 acceptance

\$8,904.17	DCBX1020RL	2 Note
\$10,283.33	DCBX1030RL	3 Note
\$12,033.33	DCBX1040RL	4 Note



MC600RL SERIES REAR LOAD CHANGER

STANDARD CHANGE-MAKERS

STANDARD FEATURES:

- Pyramid APEX-7000 bill acceptor
- Multiple hopper configurations
- 34" H x 29 1/4" W x 18" D
- Expanded function module
- 370 lbs shipped freight fully assembled
- **New K5000 hopper!**
- Dual redundancy feature
- (2) 1,000 bill stackers
- Powder coated plate 33 1/4" W x 38" H

*** MUST SPECIFY CURRENCY TO BE DISPENSED IN ORDER NOTES: TOKENS, QUARTERS, OR DOLLAR COINS. IF TOKENS, MUST SPECIFY TOKEN SIZE AND PAYOUT PER DOLLAR**

PRICE	PART #	HOPPERS	CAPACITY
\$8,104.17	DC620RL-DA	2	18,000 Quarters
\$8,445.83	DC630RL-DA	3	15,400 Quarters
\$9,033.33	DC640RL-DA	4	12,800 Quarters



MC700 & MC720DA CHANGERS

STANDARD CHANGE-MAKERS

STANDARD FEATURES:

- Front load, high security
 - 28" H x 17" W x 13" D
 - Pyramid APEX-7000 bill acceptor - 500 bill stacker
 - *** MUST SPECIFY CURRENCY TO BE DISPENSED IN ORDER NOTES: TOKENS, QUARTERS, OR DOLLAR COINS. IF TOKENS, MUST SPECIFY TOKEN SIZE AND PAYOUT PER DOLLAR**
- OPTIONAL FEATURES:**
- CPI Talos Acceptor(s)
 - Pedestal stand
 - 500 bill stacker
 - Audit meters
 - Heater
 - Remote reporting

PRICE	PART #	HOPPERS	ACCEPTORS	CAPACITY
\$3,025.00	DC700	1	1	4,200 Quarters
\$4,329.17	DC720DA	2	2	5,600 Quarters



CHANGERS & COUNTERS



STANDARD CHANGE-MAKERS

MC300RL REAR LOAD MODULAR SERIES CHANGER



STANDARD FEATURES:

- Pyramid APEX-7000 bill acceptor - 500 bill stacker
- Hopper - K5000 \$800 capacity
- Cabinet: 9" W x 32" H x 13" D
- Powder coated plate: 13" W x 36" H
- 135 lbs. shipped freight fully assembled

OPTIONAL FEATURES

- CPI Talos Bill Acceptor
- Larger hopper - \$1,300 capacity
- Audit meter • Heater

MUST SPECIFY CURRENCY TO BE DISPENSED IN ORDER

NOTES: TOKENS, QUARTERS, OR DOLLAR COINS. IF TOKENS, MUST SPECIFY TOKEN SIZE AND PAYOUT PER DOLLAR*

\$2,766.67 DC300RL

NEW K5000 HOPPER!



MC315RL-CC REAR LOAD CREDIT CARD TOKEN MACHINE

STANDARD FEATURES:

- Uses Nayax (shown), ePort *
- Supplied reader will be factory-installed
- Accepts credit cards to vend tokens
- 4 lighted selection buttons
- EF PLUS Module included
- Cabinet: 9" W x 32" H x 13" D
- Powder coated plate: 13" W x 36" H

OPTIONAL FEATURES:

- Heater • Receipt/audit printer

*** CREDIT CARD READER MUST BE PURCHASED SEPARATELY (MDB TYPE REQUIRED) MUST SPECIFY WHICH READER WILL BE USED. MUST SPECIFY DIAMETER AND THICKNESS OF TOKENS BEING DISPENSED. MUST SPECIFY PAYOUT.**

\$5,250.00 DC315RL-CC

NEW K5000 HOPPER!



EXPANDED FUNCTION PLUS MODULES FOR EXISTING MC, BX OR BCX MACHINES

STANDARD FEATURES:

- Audit reports/perpetual audit report: configurable PIN access
- Acceptance and payout setup menu
- Last 20 bills accepted with time & date stamp
- Error log reports and audit printer compatible
- Quick email/text audit report function
- Requires wired internet connection for remote reporting

**Optional EF Plus Module Now Available For Text Or Email Reporting On All Models
* Mc500RLDA Requires One Kit Per Side To Report On Both Sides**

PRICE	PART #	FOR MODELS
\$640.20	DCP4K01293-FI	MC200, MC300, MC400, MC500*, MC520, MC600, MC800
\$640.20	DCP4K01293-FI2	All BX Models ONLY
\$640.20	DCP4K01293-FI3	MC100
\$640.20	DCP4K01293-FI4	MC700 & MC720DA
\$640.20	DCP4K01293-FI5	MC9XDA
\$640.20	DCP4K01293-FI8	MC400RL-SLIM

MC520RL-DA REAR LOAD MODULAR SERIES CHANGER



STANDARD FEATURES:

- (2) Pyramid APEX-7000 bill acceptors - 500 bill stacker
- Dual redundancy for added reliability
- (2) Hoppers - \$1,600 capacity
- Cabinet: 18" W x 32" H x 13" D
- Powder coated plate: 22" W x 36" H
- 183 lbs. shipped freight fully assembled

OPTIONAL FEATURES

- CPI Talos Bill Acceptor
- Larger hopper - \$1,300 capacity each
- Audit meter • EF Plus Module

**MUST SPECIFY CURRENCY TO BE DISPENSED IN ORDER
NOTES: TOKENS, QUARTERS, OR DOLLAR COINS. IF TOKENS, MUST SPECIFY TOKEN SIZE AND PAYOUT PER DOLLAR**

\$4,862.50 DC520RL-DA

NEW K5000 HOPPER!

MC400RL-SLIM REAR LOAD CHANGER



STANDARD FEATURES:

- Pyramid APEX-7000 bill acceptor - Rear load, 500 bill stacker
- (2) hoppers - \$1,600 capacity
- Cabinet 12" W x 38.5" H x 18" D
- Powder coated faceplate with tough Lexan graphics decal, 18" W x 43" H
- 209 lbs. shipped fully assembled

OPTIONAL FEATURES:

- Stainless Steel faceplate
- 2nd bill acceptor
- Upgrade to CPI Talos Acceptor(s)
- EF PLUS Module

**MUST SPECIFY CURRENCY TO BE DISPENSED IN ORDER
NOTES: TOKENS, QUARTERS, OR DOLLAR COINS. IF TOKENS, MUST SPECIFY TOKEN SIZE AND PAYOUT PER DOLLAR.**

\$4,050.00 DC400RL-SLIM

NEW K5000 HOPPER!

MODULAR SERIES RETROFIT KIT FOR ROWE™ MODEL BC1400

***REQUIRES APPROXIMATELY 2 HOURS FOR INSTALLATION**

- Hopper platform/bracket with 2 hoppers • Power supply assembly
- Bill acceptor bracket/cover plate w/CPI Talos Acc.
- All hardware and cables are included • Optional faceplate decal & EF+ Module

PRICE	PART #	KIT
\$2,350.82	DCP4K07400-FI*	(2) Quarter Hoppers
\$2,350.82	DCP4K07400-FI1*	(2) \$1 Coin Hoppers
\$2,350.82	DCP4K07400-FI2*	(1) Quarter Hopper and (1) Dollar Coin Hopper
\$76.66	DCP6D01132	Graphic decal for BC1400 when using the 4K07400-FI Conversion Kit

STANDARD CHANGER PARTS

PRICE	PART #	DESCRIPTION
\$525.30	DCP5HK5505	5HK5505 Quarter Hopper for MC Series Front Load Changers \$700 Capacity
\$577.95	DCP5HK5510	5HK5510 Quarter Hopper for MC Series Rear Load Changers \$800 Capacity
\$577.95	DCP5HK5353	5HK5353 Dollar Hopper for MC Series Rear Load Changers \$2500 Capacity
\$525.18	DCP5HK5161	5HK5161 Dollar Hopper for MC Series Front Load Changers \$2100 Capacity

CHANGERS & COUNTERS

HAMILTON

HAMILTON CHANGERS



MODEL RNS REAR LOAD
HAMILTON CHANGERS

- **CHANGES/PAYS:** \$1, \$5, \$10, \$20, to QTRS
- **MAXIMUM CAPACITY:** 4,800 qtrs (\$1,200)
- **DIMENSIONS:** 34½" H x 9" W x 13" D
- **FACEPLATE:** 38½" H x 12" W
- **WEIGHT:** 150 lbs.

STANDARD FEATURES:

- Bill stacker
- 7 gauge carbon steel cabinet
- 7 gauge stainless steel faceplate
- Heater & weathershield (no extra cost - XE Validator ONLY)
- Two heavy duty Medeco® plug locks
- Power: 120VAC 60Hz
- Weight: 150 lbs.

OPTIONAL FEATURES:

- Token face panel (no extra cost)
- Audit Pro 2000 Controller
- Portable thermal report printer
- **CUSTOMIZABLE FACE PANEL AVAILABLE!**

\$3,294.79	HC075	XE Validator
\$3,125.61	HC075-C	Coinco Validator
\$3,294.79	HC075-M	CPI Talos Validator



MODEL ER-60 ECONOMY REAR LOAD
HAMILTON CHANGERS

- **CHANGES/PAYS:** \$1, \$5, \$10, \$20, to QTRS
- **MAXIMUM CAPACITY:** 2,400 QTRS (\$600)
- **DIMENSIONS:** 20¾" H x 15" W x 13" D
- **WEIGHT:** 147 lbs.
- **FACEPLATE:** 24¾" H x 18" W

STANDARD FEATURES:

- Bill stacker and bulk load hopper
- 7 gauge carbon steel cabinet, 7 gauge stainless steel faceplate
- Heater & weathershield (no Extra cost - XE Validator ONLY)
- Two heavy duty Medeco® plug locks
- Power: 120VAC 60Hz

OPTIONAL FEATURES:

- Token face panel (no extra cost)
- Audit Pro Controller 2000
- Portable thermal report printer
- **CUSTOMIZABLE FACE PANEL AVAILABLE, CALL FOR DETAILS!**

\$2,759.91	HC060	XE Validator
\$2,575.62	HC060-C	Coinco Validator
\$2,759.92	HC060-M	CPI Talos Validator



MODEL 1200FL-S
FRONT LOAD VERSATILITY
HAMILTON CHANGERS

- **CHANGES/PAYS:** \$1, \$5, \$10, \$20, to QTRS
- **MAXIMUM CAPACITY:** 4,800 qtrs (\$1,200)
- **DIMENSIONS:** 26" H x 19½" W x 13" D
- **WEIGHT:** 140 lbs.

STANDARD FEATURES:

- Bill stacker
- 11 gauge stainless carbon
- Heater & weathershield (no extra cost - XE Validator ONLY)
- Two heavy duty Medeco® plug locks
- Power: 120VAC 60Hz

OPTIONAL FEATURES:

- Token face panel (no extra cost)
- Audit Pro 2000 Controller
- Portable Thermal Report Printer
- Console Base
- **CUSTOMIZABLE FACE PANEL AVAILABLE, CALL FOR DETAILS!**

\$3,210.20	HC065	XE Validator
\$3,210.20	HC065-M	CPI Talos Validator



MODEL DRS DUAL REAR LOAD
HAMILTON CHANGERS

- **CHANGES/PAYS:** \$1, \$5, \$10, \$20, to QTRS
- **MAXIMUM CAPACITY:** 9,600 QTRS (\$2,400)
- **DIMENSIONS:** 34¾" H x 18 3/16" W x 14 7/16" D
- **FACEPLATE:** 38 5/16" H x 21½" W
- **WEIGHT:** 230 lbs.

STANDARD FEATURES:

- Bill stacker
- 7 gauge carbon steel cabinet
- 7 gauge stainless steel faceplate
- Heater & weathershield (no extra cost - XE Validator ONLY)
- Two heavy duty Medeco® plug locks
- Power: 120VAC 60Hz

OPTIONAL FEATURES:

- **CUSTOMIZABLE FACE PANEL AVAILABLE, CALL FOR DETAILS!**
- Token face panel (no extra cost)
- Audit Pro 2000 Controller
- Portable thermal report printer

\$5,663.25	HC077	XE Validator
\$5,324.89	HC077-C	Coinco Validator
\$5,663.25	HC077-M	CPI Talos Validator

CHANGERS & COUNTERS

HAMILTON CHANGERS



BILL TO BILL DISPENSER SERIES, REAR-LOAD

HAMILTON CHANGERS

- Break larger bills down to smaller bills and/or coins. This bill dispenser is offered with a dual cassette to give more versatility, and the optional coin hopper will allow dispensing of either coins or tokens along with bills. Choose Hamilton's XE bill validator or several of the third party options. With a CPI Talos® validator, you can accept up to \$100 bills. Possible configurations for the exchanger include: bill dispensing only, bill & coin dispensing, Tokennote® dispensing only, Tokennote® & coin dispensing, and bill/Tokennote®/coin dispensing. Connect your bill to bill dispenser to the Data Access Network (D.A.N.) to remotely access audit reports, track input/output of the hopper and bill dispenser, as well as clear soft errors and shut the machine down.

- **HANDHELD KIT REQUIRED FOR PROGRAMMING**
- **HOPPER: \$1200 QUARTER HOPPER CAPACITY**
- **LOCKS: 2 HEAVY DUTY MEDECO® PLUG LOCKS**
- **POWER: 120 VAC 60 HZ**
- **APPROXIMATE WEIGHT: 230 LB**

STANDARD FEATURES:

- Hamilton XE Validator
- 1000 bill stacker
- Two heavy duty Medeco® locks
- eGL Controller (DAN Compatible)
- 7 gauge stainless steel faceplate
- 11 gauge stainless steel cabinet
- Dual bill/note dispenser

OPTIONAL FEATURES:

- **CUSTOMIZABLE FACE PANEL AVAILABLE, CALL FOR DETAILS!**
- CPI Talos, Coinco or XE Validator
- Coin hopper 4,800 qtrs (\$1,200)
- Portable thermal printer

CABINET SIZE AND MINIMUM WALL OPENING:

- 34 3/4" H x 18 3/16" W x 14 7/16" D (88.3 cm H x 46.4 cm W x 36.8 cm D)

FACEPLATE:

- 38 5/16" H x 21 5/8" W (97.3 cm H x 54.9 cm W)

PRICE	PART #	DESCRIPTION
\$6,911.34	BBC2200-M	Bill to Bill/Change Dispenser with CPI Talos Validator
\$6,911.34	BBC2200-XE	Bill to Bill/Change Dispenser with XE Validator



3600RL - HEAVY DUTY REAR-LOAD CHANGER

HAMILTON CHANGERS

- The 3600RL offers the most versatility of any rear load changer. It can be configured with one, two or three high-capacity hoppers, and one or two validators. A multi-coin acceptor may be added to fit the needs of your business.
- When used with the Data Access Network (D.A.N.), you have the ability to remote into the changer and clear certain error codes and view audits.

- **HANDHELD KIT REQUIRED FOR PROGRAMMING**

FEATURES & BENEFITS:

- Changes/Pays: \$1, \$5, \$10, \$20 to coins or tokens
- Two Hamilton XE validators (with Tokennote® acceptance)
- 1,000 bill stacker
- Cabinet: 7 gauge carbon steel
- Faceplate: 7 gauge stainless steel
- Heater pad (with XE validator only)
- Weather shields
- Two heavy-duty Medeco® plug locks
- Audit Pro 2000 controller
- Max. capacity: 1 hopper - 4,800 quarters; 2 hopper - 9,600 quarters; 3 hopper - 14,400 quarters
- Power: 120 VAC 60 Hz
- Weight: 325 lbs./147 kg
- ETL listed

- **CUSTOMIZABLE FACE PANEL AVAILABLE, CALL FOR DETAILS!**

CABINET SIZE AND MINIMUM WALL OPENING:

- 34 7/8" H x 21 1/4" W x 14 3/8" D

FACEPLATE:

- 38 3/8" H x 24 3/4" W

PRICE	PART #	DESCRIPTION
\$5,663.25	HC3600RL	2 XE Validators 3 Hoppers
\$5,694.20	HC3600RL-M	2 CPI Talos Validators 3 Hoppers

CHANGERS & COUNTERS

HAMILTON

HAMILTON PARTS

- In order to ensure right part is ordered, please give Hamilton's part number.
- All items listed below are items we stock, but we can order **ANY** part from Hamilton.



SLUGBUSTER (ACW4-5)

- 3 pin with flat black plug

\$190.34 HCP083



SLUGBUSTER (GOLD LINE)

- 6 pin with square black plug

\$170.00 CB037N



DENOMINATION PACK

\$2.70 HCP962083B



GOLD LINE PRICE & FUNCTION SET

\$26.20	HCP965091B	Blue Text
\$26.20	HCP965091W	White Text

INCLUDES:
WASH NAMES,
FUNCTIONS, &
PRICING
OPTIONS



PUSH BUTTONS FOR GOLD LINE®

\$27.13	HCP499305	Blue
\$27.13	HCP499373	Red



ACW 4 & 5 NEW BUTTON KITS

\$44.48	HCP1000077	Blue
\$44.48	HCP1000078	Red



HOPPER MOTOR

\$134.89 HCP110096B



RAINSHIELD

\$26.70 HCP600318A

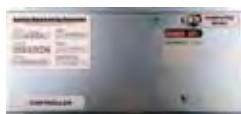

C-2000 CONTROLLER

\$502.11 HCP492000A



SLIDER FACEPLATE FOR XE

\$43.20 HCP600282A



OUT OF SERVICE LAMP

\$6.97 HCP470080



HAMILTON CRANK (ALLEN WRENCH)

\$11.75 HCP635040



SPRING LOADED LOCK NUT

\$6.27 HCP900336



FLUSH MOUNT CARD READER KIT

\$348.54 HCP1000119



CONTACT BLOCK

\$18.56 HCP473023A



HARNESS

\$170.58 HCP481005

CHANGERS & COUNTERS

HAMILTON PARTS



VARIOUS HAMILTON CHANGER PARTS

HAMILTON CHANGER PARTS

- In order to ensure right part is ordered please give Hamilton's part number
- We can order any part from Hamilton

PRICE	KR PART #	HAMILTON PART #	DESCRIPTION
\$39.44	HCP467000A	46-7000A	Coin Mech Transformer Assembly
\$131.01	HCP480006A	48-0006A	Heater Assembly with Thermostat
\$3.69	HC090	20-0042	Black belt
\$3.25	HCP960046	96-0046	Decal (Lift to insert bills)
\$3.06	HCP900275	90-0275	Bolt/Lock
\$11.65	HCP499396	49-9396	Thermal Printer Paper G/L 2.25" Wide
\$65.01	HCP110017A	11-0017A	Hopper Bowl Assembly
\$612.35	HCP110101	11-0101	Hopper Assembly Quarter for ACW-5
\$612.35	HCP110103	11-0103	Hopper for ER60
\$34.51	HCP499302	49-9302	Fan - ACW Gold Line®
\$355.17	HCP1000126	100-0126	ACW 4/5' Credit Card Reader Insides
\$197.97	HCP63042001	63-0420-01	Standard ACW 4&5 Face Panel, no Credit Card
\$1.38	HCP468613	46-8613	O-Ring Drive Belt for XE Validator
\$211.01	HCP499448	49-9448	IDTECH Surface Card Reader
\$15.42	HCP473032	47-3032	ACW Buttons 4 & 5 - BLUE
\$15.42	HCP473022	47-3022	ACW Buttons 4 & 5 - BLACK
\$15.42	HCP473021R	47-3021	ACW Buttons 4 & 5 - RED

XE VALIDATOR

HAMILTON CHANGER PARTS



- UPDATING THE XE VALIDATOR IS AS SIMPLE AS AN EPROM CHANGE ALLOWING NEW CURRENCY RELEASES TO BE HANDLED WITH EASE. HAMILTON'S VERSATILE DESIGN ALLOWS THE XE TO BE A DIRECT REPLACEMENT FOR MOST HV SERIES.

- Converts most Hamilton Changers to accept NEW \$5, \$10, \$20 and Tokenote®
- Will not work in S540XR or 540XRS
- Dual flipper/gate system
- Improved side scan system
- Stepper motor
- Belt drive system

\$795.54	HCXE	Validator
----------	------	-----------

STACKER

HAMILTON CHANGER PARTS



- Holds up to 1000 bills
- Easy bill removal from front or back

\$249.65	HC080
----------	-------

STA STACKER CONVERSION KITS

HAMILTON CHANGER PARTS

- The STA validator is no longer produced, but kits are available that allow integration of an XE validator with an STA stacker

\$165.94	HCP1000089	All changers (front and rear load)
\$81.52	HCP1000184	Gold Line® ACW

2 POSITION PIVOT-OUT HOPPER

HAMILTON CHANGER PARTS



- Full pivot hopper for easy emptying and cleaning
- Dispenses quarter size coins or tokens
- Only 2 moving parts
- 4800 quarters, 9200 dimes, 5500 nickels

CALL	HC082
------	-------



CPI TALOS VALIDATOR KIT

HAMILTON CHANGER PARTS

- Validator and hardware to add a CPI Talos Validator device to a Hamilton ER-60, RNS, and DRS machines
- DRS REQUIRES TWO KITS
- 120V

\$874.17	HCP602101A
----------	------------

CHANGERS & COUNTERS



ROWE® CHANGERS



BC-1400A REAR LOAD

ROWE CHANGERS

- Now with American Changer components!
- Accepts \$1, \$5, \$10, \$20 bills
- 3-point locking system
- Coin Capacity: 4,800 quarters per hopper (9,600 total)
Dollar coin/token (\$2100 per hopper)
- CPI Talos with 1,000 note stacker
- Weight: 171 lbs.
- 60Hz
- Dual hoppers
- Medeco locks & keys
- Stainless steel faceplate
- Cabinet: 38⁵/₁₆" H x 12⁷/₁₆" W x 18¹/₄" D
- Faceplate: 43" H x 18" W
- UL Approved
- 120 VAC
- 225 watts/4 amps

RC1400-M

Non-Returnable

Ask about the RC2800-M, which is two RC1400-M's with two separate control boards & power supplies, under one face plate!

BC-1600A REAR LOAD

ROWE CHANGERS

- Now with American Changer components!
- Accepts \$1, \$5, \$10, \$20
- Dimensions: 38.62" H x 12.06" W x 18.25" D
- Weight 160 lbs
- Remote Access Board included: Monitor the status of an American Changer machine remotely. Allows for remote auditing and remote payouts from a machine. An email or text will be sent if the machine experiences a failure.
- Dual coin hoppers, each with a capacity of 6,150 quarters/4,825 \$1 coins (12,300 quarters/9,650 \$1 coins total)
- Recyclers options are available - ask about the BC-1600A-HSB (KR Part # **RC1600RL-01**) or BC-1600A-HVB (KR Part # **RC1600RL-02**)
- Dual CPI Talos Validator with 500 note stackers
- Medeco locks & keys
- Faceplate: 43" H x 18" W

RC1600RL-00

CPI Talos Machine

RC1600RL-01

with 2-CPI Talos Bill Recyclers and 2 Hoppers

RC1600RL-02

High Visibility Bezel with 2 CPI Talos Bill Recyclers and 2 Hoppers

Non-Returnable

BC-1500A FRONT LOADING BILL CHANGER

ROWE CHANGERS

- Front loading unit
- Dual CPI validators with two 500 note stackers
- 500 bill acceptor stacker for incoming bills
- Dual hoppers have capacities of 6,150 quarters / tokens each (12,300 total)
- 1 Medeco lock and 2 keys Included
- Remote alert features for hopper empty and stacker full
- MDB compatible
- Dimensions: 38.62" x 12.06" x 18.25"

RC1500

Non-Returnable

ROWE® UPGRADE KITS

ROWE® TO AMERICAN CHANGER UPGRADE KITS

- Convert your existing Rowe machine to American Changer internal components
- The following models are compatible: 2612, 2712R
- Kits include brackets, mounting plates, hopper extensions, chutes, and harnesses
- Hopper Capacities: 4,800 quarters per hopper
- Uses your existing cabinet!
- Need to freshen up your decal? We sell replacement decals!

New!

BC-1200A-KIT

BC-1600A-KIT

Non-Returnable

BC-1500A-KIT

BC-3200A-KIT

ROWE® TO AMERICAN CHANGER CONVERSION KITS

- Universal Board
- Power Supply & Cord
- (2) American Changer Hoppers (each hopper holds up to 4,800 quarters)
- Optional Remote Access Board can be added to kit

KIT #

BILL ACCEPTOR

BC-1400A-KIT

Talos Bill Acceptor with 500 note stacker

BC-2800A-KIT

Talos Bill Acceptor with 500 note stacker

BC-3500A-KIT

Talos Bill Acceptor with 500 note stacker

KIT #

BILL ACCEPTOR

BC-1400A-KITP

Pyramid Bill Acceptor with 500 note stacker

BC-2800A-KITP

Pyramid Bill Acceptor with 500 note stacker

New!



CHANGERS & COUNTERS

ROWE® UPGRADE KITS

BC-1400A-KIT

Convert your existing Rowe™ | BC-1400 to a BC-1400A



What's included?

1 - CPI Validator*

CPI Validator accepts \$1, \$5, \$10, & \$20 denominations. Can be programmed for other currencies. CPI Talos Validator models currently compatible are: AE2632, 2602 with down stacker, T702, and T602.

2 - Hoppers with Extensions**

Each hopper holds 4,800 quarters/tokens (4,400 \$1 coins). BC-1400A holds 9,600 quarters/tokens (or 8,800 \$1 coins) total.

1 - Universal Board

American Changer's Universal Board allows one validator/two hoppers with one power supply.

1 - Power Supply + Power Cord

Switchable input: 115/230 Volt, 50/60Hz. Various plug configurations. Power consumption: Board 10W max | Hopper 22W max | Validator 50W max.

Kit includes brackets, mounting plates, hopper extensions, chutes, and harnesses. | For existing BC-2800's, the components will be the same as above x2.

Additional Upgrade Options are available, such as Remote Access boards, 700 or 1,000 note stackers, decals, and more!

* Validator stacker capacity based on USA banknote - 6.21" L x 2.62" W (0.0043" thick) or 5.5956 cm L x 6.6294 cm W. Weight: 1 gram

** Hopper capacities based on 2014 USA Quarter size (0.955" or 1.75mm, weight 0.182 Troy ounces or 5.670 grams) or USA \$1 coin. (1.043" or 26.5 mm, weight 0.260 Troy ounces or 8.100 grams). Hopper capacities increase or decrease depending on coin size used.

CHANGERS & COUNTERS

CURRENCY/COIN COUNTERS & SORTERS



SC-1700 BANKNOTE COUNTER

PAYCOMPLETE

PayComplete

- The PayComplete SC-1700 is a fast, high capacity banknote counter featuring a variety of smart functions. Counts large quantities of banknotes at a fast rate, with reliable processing and advanced counterfeit detection measures. Numerous modes of counting, including preset value count or batch count, with automatic or manual start. Counter comes with a 3.5-inch Segment LCD display that provides value part, pieces part, error code part and all function parts. Easy-to-operate buttons for controls, while simple and easy passage access allow for clearing out jammed notes with ease. Perfect for car wash, vending, laundromat, and other high-volume cash collection and counting duties.

STANDARD FEATURES:

- Voltage: 110/220 VAC
- Counting Speed:
 - Low: 900 pieces/minute
 - Middle: 1200 pieces/minute
 - High: 1500 pieces/minute
- Hopper Capacity: ~500 bills
- Stacker Capacity: 200 bills

\$503.75

CC1700



COMPACT COIN COUNTER

AMERICAN CHANGER



- Compact and portable coin counter
- Counts U.S coins and tokens
- Continuous or preset counting modes
- Full batching capabilities
- Ambient Temp. For Use: 32 °F - 130 °F
- Direct, easy access/safety interior
- Counts 1800 pieces per minute
- Hopper Capacity: 1500 coins
- Programmable bag stops
- Coin Thickness: 0.8 - 3.8mm
- Coin Diameter: 14 - 34mm
- Features a (7) digit LED display
- 8¾"W x 12¾"D x 6¾"H
- Weighs 19.60 lbs.

CALL

AMC301



MODEL 360 COIN COUNTER

PAYCOMPLETE/SCAN COIN

PayComplete **SCAN COIN**

- The latest coin counters from PayComplete, SC 350/360, fill an important gap between heavy-duty counters and small back office machines. These high-speed coin counters combine superior versatility with many advanced features, which are fitted as standard. Large, automatic hopper with filling.

SPECS:

- Diameter Range: 15-34 mm/0.56-1.34" or 18-37.5 mm/0.71-1.48"
- Thickness Range: 0.8-3.4 mm/0.03-0.15"
- Voltage: 110/230 V, 60/50 Hz 110/230 V, 60/50 Hz
- Power: 120 W
- Speed: up to 3,000 coins/min.
- Weight: 43.0 lbs
- 12.0"W x 18.9"D x 15.0"H

\$1,654.13

CC360



HITACHI IHUNTER 110 - 2 POCKET CURRENCY DISCRIMINATOR

COIN, CURRENCY, AND DOCUMENT SYSTEMS

- Intelligent and reliable banknote counter, which uses image processing technology to recognize banknotes and to discriminate denominations. The 110 features Full Color Imaging with Dual CIS scanning, which scans both sides of the bills to reduce unwanted rejects. The 2-pocket design, with a stacker and a reject pocket, allows the 110 to count and off-sort without stopping. Having a reject pocket allows operators to perform daily cash-processing jobs without any interruption.

FEATURES:

VARIETY OF COUNTING MODES:

- Mix: Counts mixed money, providing grand total and itemized count.
- Single (sorting): Counts 1 denomination and sorts all other denominations into reject pocket.
- Face: Faces all bills (heads up or heads down)
- Orientation: Orientates all bills in proper direction: (heads facing right or heads facing left)
- Count: Counts all bills, providing quantity total.
- Dual CIS Scanner (scans both sides of bills to reduce unwanted rejects.)
- Full counterfeit detection
- 4.3-inch color touch ccreen
- Easy upgrade (USB flash drive)
- Easy jam removal (2 openings from front and rear side)

SPECIFICATIONS:

- Pockets: 2
- Value Count: Max. 1300 notes/min
- Mixed Count: 700-900 notes/min
- Weight: 30.64 lbs.
- Hopper Capacity: 500-700 notes
- Stacker Capacity: 200-250 notes
- LAN/USB Interface
- Reject Capacity: 60-100 notes
- 100~240 VAC, 50/60 Hz
- Counterfeit Detection: CIS/IR/MG/UV

\$2,285.00

CC8000

CHANGERS & COUNTERS

KLOPP
INTERNATIONAL, INC.

COIN SORTING/BAGGING/WRAPPING



RIGID TRAY
(OPTIONAL)

MANUAL SORTER

KLOPP INTERNATIONAL, INC.

- This easy to operate manual sorter will separate a mix of coins and tokens into 4 different bins, wet or dry at a rate of 1,000 per minute. U.S. made of cast aluminum and hardened steel, it has a 1 year warranty. Customized sorters available upon request.
- Optional rigid coin tray available (**CB1022**)

\$1,382.93	CB1019	Manual Sorter
\$1,417.07	CB1019-1S	Tokens - (smaller than \$1.00 coin)
\$1,451.22	CB1019-1L	Tokens - (larger than \$1.00 coin)
\$153.66	CB1022	Rigid Tray

GREAT FOR WET COINS!

MODEL CMB SHOWN



SINGLE COIN COUNTERS/BAGGERS

KLOPP INTERNATIONAL, INC.



- Extremely popular for counting WET coins and tokens
- Same heavy-duty construction as Model CM and Model CE
- Bags (1) type of coin only. You specify which coin. Machine does not wrap.
- Will count into a bagging tube. Great for bank deposits or re-circulating coins back into bill changers.
- Processes 1,200 quarters/per min. (CMB), 1,400 quarter/per min. (CEB)
- Comes equipped with (1) all purpose bagging tube.

\$998.78	CB1025	Model CMB - Manually Operated
\$1,434.15	CB1035	Model CEB - Electrically Operated*

GREAT FOR WET COINS!

MODEL CE SHOWN



CB1020

MULTIPLE COIN COUNTER/WRAPPER/BAGGER

KLOPP INTERNATIONAL, INC.



- Extremely popular for counting WET coins and tokens
- Made of cast aluminum and hardened steel, not plastic
- Counts, wraps and/or bags all US coins and 5 token sizes, one type of coin at a time
- Wraps \$1,000.00 in quarters in just 20 minutes!
- Both CE and CM process 1,800 coins per minute
- Machines include (3) Nylon wrapping tubes of your choice (Quarter, Dime, Nickel) OR (1) Nylon wrapping tube and (1) all-purpose bagging tube
- Machines Do NOT Sort

\$1,229.27	CB1000	Model CM - Manually Operated
\$1,664.63	CB1010	Model CE - Electrically Operated
\$35.90	CB1020	Universal Bagging Tube

SORTER AND COUNTER REPLACEMENT PARTS

KLOPP INTERNATIONAL, INC.

PRICE	PART #	KLOPP #	DESCRIPTION	MACHINE
\$13.46	CB1033	93-5810	Upper Discharge Wheel	Counters (ALL)
\$40.38	CB1032	93-2210	Lower Discharge Wheel	Counters (ALL)
\$1.58	CB1034	3-9255	Rubber Tray Tip	Counters (ALL)
\$1.79	CB1036	3-3200	Base Feet	Counters and Sorters (ALL)
\$8.08	CB1040	3-1349	Disc Shaft Pinion Gear (Manual and Electric)	Counters (ALL)

PRICE	PART #	KLOPP #	DESCRIPTION	MACHINE
\$16.60	CB1044	4-2111	CE Drive Wheel (Electric)	Counters - Electric ONLY
\$25.13	CB1046	4-3900	CE Drive Belt (Electric)	Counters - Electric ONLY
\$10.26	CB1066	0-4000	Klopp Klean - 4 oz Rubber Cleaner	Counters (ALL)
\$17.05	CB1060	5-1520	SM Drive Belt Gear	Sorters - Manual ONLY
\$10.77	CB1062	5-6500	SM Pinion Gear	Sorters - Manual ONLY
\$0.68	CB1027	3-1360	Disc Insert (1 per pack)	Counters - Electric ONLY

ALL PRICES ARE F.O.B. AND ARE SUBJECT TO CHANGE WITHOUT NOTICE • NO C.O.D.'S

1-800-233-3873 • (717) 684-6721 • FAX (800) 446-0495 • KLEENRITE.COM

285

CHANGERS & COUNTERS

COINCOUNTERS & CLEANERS



MODEL 303 ELECTRIC COIN COUNTERS

PAYCOMPLETE/SCAN COIN

- Up to 2700 coins/minute
- Easy to read 6-digit LED display
- Small coin off-sort allows separation of mixed denominations
- Standard machine has settings for six denominations and can be adjusted to handle virtually any coin or token
- Microprocessor controlled with non-volatile memory for storing all vital data - no battery backup required

\$799.63 **CC303**



MODEL 313 COIN COUNTER

PAYCOMPLETE/SCAN COIN

- 3 memory levels with subtotal, grand total and bag count
- Up to 2700 coins/ minute
- Easy to read 6 digit LED display
- Standard machine has settings for six denominations and can be adjusted to handle virtually any coin or token
- Microprocessor controlled with non-volatile memory for storing all vital data - no battery backup required

\$939.06 **CC313**

CB1048

CB1050



CB1047

KCS SERIES COIN COUNTING SCALES

KLOPP INTERNATIONAL, INC.

KLOPP
INTERNATIONAL, INC.

- 6 pre-programmed keys for all US coins
- 4 extra keys allow for programming tokens
- Battery powered
- Tare function allows the user to eliminate the weight of a bucket or coins scoop for faster counting
- 60 lbs. capacity - up to \$1,000 in quarters

\$368.42 **CB1050** \$1000/Quarters Max Model KCS-60

KCS SERIES COIN COUNTING SCALES

KLOPP INTERNATIONAL, INC.

KLOPP
INTERNATIONAL, INC.

\$18.85 **CB1047** Black Scoop, 10" diameter
\$89.63 **CB1048** Carrying Case

TC TOKEN CLEANER WITH 30 MINUTE TIMER

KLOPP INTERNATIONAL, INC.

KLOPP
INTERNATIONAL, INC.

- The Model TC (Token Cleaner) is a large tabletop vibratory bowl that is ideal for cleaning and polishing tokens and/or coins. Just add the included 7 lbs of Dry-Cleaning Media to the bowl, up to 650 tokens or coins and turn on the machine. Check the token or coins periodically for desired cleanliness, then remove them from the media by using the included Sift Tray and any 5-gallon bucket.

FEATURES:

- Heavy-duty polyethylene tub and lid
- 650 qty token capacity
- 5ft power cord
- Tabletop design
- 90 day warranty

SPECIFICATIONS:

- Electrical: 120V / 60Hz
- Weight Capacity: 18 lbs
- Drum Opening: 11" Diameter
- Overall Dimension: 15"W x 18"H

INCLUDES:

- Token cleaner
- 7 lbs dry cleaning media
- 14" sift tray

\$426.83 **CB3000**

ADDITIONAL PRE-CONDITIONED DRY MEDIA

KLOPP INTERNATIONAL, INC.

KLOPP
INTERNATIONAL, INC.

- (2) 3.5 lb. bags

\$39.27 **CB3100**



Includes:
Token Cleaner
7 lbs Dry Cleaning Media
14" Sift Tray



CHANGERS & COUNTERS



CAR WASH TOKENS

HIGH SECURITY CAR WASH TOKENS

HOFFMAN MINT

MINTED IN FORT LAUDERDALE, FLORIDA

- Unique alloys - New to the industry | Eliminate unwanted tokens from competitors | Token sizes similar to a quarter & dollar coin | Reduce theft & vandalism | Pricing flexibility & promotional opportunities | Walkaway profit | Reduce operating costs
- A variety of sizes and alloys are offered because each variation has a unique electronic signature enabling coin mechanisms to distinguish them from other tokens. We do not recommend the use of 260 alloy since it is common in amusement applications. We recommend you survey your competitors in the area who are using tokens, either by talking to the owners or by collecting samples from their locations. By comparing your competitors' tokens to our samples, you can then make a choice unique to your location. If you're fortunate enough to be the only token user in your market, then make your choice based on the look, feel, and budget that appeals to you. Having your token customized with your name or logo adds advertising impact. **COINS ARE ACTUAL SIZE.**



MINIMUM ORDER IS 1,000 TOKENS

- PICK THE SIZE:**
 - .900" (slightly smaller than a Quarter)
 - .984" (slightly larger than Quarter)
 - 1.012" (slightly smaller than a Dollar Coin)
 - 1.073" (slightly larger than Dollar Coin)
 - 1.125" (larger than Dollar Coin but smaller than Half Dollar)
- PICK THE ALLOY:**
 - Alloy 230 (available in all sizes)
 - Alloy HM1 or HM2 (available in .984")
 - Alloy HM4 or HM5 (available in 1.073")
- PICK THE DESIGN:**
 - Choose generic front and back dies
 - Or customize with your logo for an additional cost
- SEE TOKEN ORDER FROM IN FRONT SECTION >** **CALL** **TOKEN**



T40
HIGH SECURITY WASH TOKENS



T40B
HIGH SECURITY WASH TOKENS



T45V
HIGH SECURITY WASH TOKENS



T41B
HIGH SECURITY WASH TOKENS



T42
HIGH SECURITY WASH TOKENS



T4
HIGH SECURITY WASH TOKENS



T42B
HIGH SECURITY WASH TOKENS



T31
HIGH SECURITY WASH TOKENS



T32
HIGH SECURITY WASH TOKENS



T44
HIGH SECURITY WASH TOKENS



T43B
HIGH SECURITY WASH TOKENS



T43C
HIGH SECURITY WASH TOKENS



T43D
HIGH SECURITY WASH TOKENS



T42C
HIGH SECURITY WASH TOKENS



T43
HIGH SECURITY WASH TOKENS



T43A
HIGH SECURITY WASH TOKENS



T45
HIGH SECURITY WASH TOKENS



T45D
HIGH SECURITY WASH TOKENS



T95B
HIGH SECURITY WASH TOKENS

CHANGERS & COUNTERS

CAR WASH TOKENS



.984 HIGH SECURITY CAR WASH TOKEN

CAR WASH TOKENS

- These .984 high-security tokens are used with sophisticated pulse coin acceptors that can detect density, diameter, and electronic signature to ensure that only these tokens can trigger your machines Alloy 230 features 85% copper and 15% zinc. Stock CAR WASH front and back designs.
- 1000 count of tokens
- Token Diameter: 0.984"/24.99 mm
- Token Thickness: 0.062"/1.57 mm
- Weight per Token: 5.4g

\$212.05 TOKEN-1001



.984 HIGH SECURITY VACUUM TOKENS

CAR WASH TOKENS

These .984 high-security tokens are used with sophisticated pulse coin acceptors that can detect density, diameter, and electronic signature to ensure that only these tokens can trigger your machines. Alloy 230 features 85% copper and 15% zinc. Stock VACUUM front and back designs.

- 1000 count of tokens
- Token Diameter: 0.984"/24.99 mm
- Token Thickness: 0.062"/1.57 mm
- Weight per Token: 5.4g

\$212.05 TOKEN-1002



CLEANING CARDS & ACCESSORIES



BILL ACCEPTOR CLEANING CARD

WITH MIRACLEMAGIC™

- 50 per box

\$38.43 CCC1000

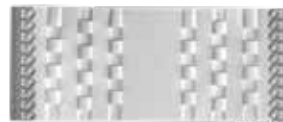

BILL ACCEPTOR CLEANING CARD

WITH WAFFLETECHNOLOGY®

- 15 per box
- Safely removes buildup to ensure bill acceptor functions properly

\$32.32 CCC2010



CREDIT CARD READER CLEANING CARD

FOR CC READERS OF ALL TYPES

- 50 per box

\$30.04 CCC1020



Keep your card readers and acceptors clean and worry free! Credit card readers and bill currency validators need to be cleaned regularly to ensure proper function and long life. Cleaning these units is very simple and easy with the great products on this page.



CREDIT CARD READER CLEANING CARD

WITH WAFFLETECHNOLOGY®

- 40 per box
- Safely removes buildup to ensure card reader functions properly
- For use on all smart card readers (dip/swipe)

\$22.10 CCC2040



CURRENCY COUNTER CLEANING CARD

WITH WAFFLETECHNOLOGY®

- 15 per box
- Safely cleans & restores in seconds
- For use on all currency counter models

\$20.58 CCC2020



CLEANING WIPES FOR COIN SORTERS & DISPENSERS

SATURATED WITH COINMAGIC™

- 50 per box
- 7" x 10" durable wipe
- Safely removes buildup and lubricates for protection

\$24.43 CCC2115



CLEANING SCRUB PAD FOR CHANGERS & COUNTERS

SATURATED WITH MIRACLEMAGIC™

- 24 per box
- Non-scratch cleaning pad cuts through stubborn buildup while protecting your technology

\$34.89 CCC2125

VACUUMS & ACCESSORIES

J.E. ADAMS CENTRAL VACUUM SYSTEMS



CENTRAL VACUUM SYSTEMS - DUAL ARCH, SINGLE ARCH & NO ARCH SYSTEMS

J.E. ADAMS

- (1) Mat holder per stanchion
- Claw hangers/crevice tool holders
- Stainless steel dust collector w/ 20 gallon dirt bin
- Stainless steel pre-filter collectors
- Industrial grade centrifugal producers
- Available in stainless steel and most colors
- Optional accessories include turbine mufflers, producer stand, colored hoses, pipe hanger kits, vacuum gauge, motor starters and more!

HELPFUL HINT:

MAKE ORDERING EASIER & FASTER - HAVE THE FOLLOWING INFORMATION READY WHEN CALLING:

- How many stalls?
- How many hose drops?
- Will you be using mounted vacuums or central vacuum system?
- Coin-op vacs or push-button vacs?



NO ARCH SYSTEM

J.E. ADAMS

- Ideal for indoor applications (mechanic shops)
- Excellent option for dealerships and car rental lots
- Sleek compact design
- Extension kit available for pipe hanging
- Quick release hose couplers
- Includes 15' black hose
- Allows easy access to claw or crevice tool
- 16¼" x 16¼" mounting plate (1" holes at 14" x 14")

CALL CVS5000



SINGLE ARCH SYSTEM

J.E. ADAMS

- Great for commercial vacuum customers
- Ideal for detail shops, car rental lots and dealerships
- Quick release hose couplers
- Stainless steel trash can holders
- Zinc primer base with a powder coated finish

CALL CVS5100



NEW
LIGHTING
& CANOPY
OPTIONS!

PRODUCER & MAIN COLLECTOR

J.E. ADAMS

TURBINE PRODUCER:

- Industrial grade centrifugal producers
- Cast aluminum impellers
- Carbon steel flanged inlets
- Automatic bearing lubricators
- 3525 RPM
- Casing is 14G CRS
- Optional accessories include turbine mufflers, producer stand and more!

MAIN COLLECTOR:

- Constructed of 12 gauge stainless steel
- (10) 1 micron filter bags
- Includes 20 gallon dust collector bin
- (2) Adjustable hinges per door for secure seal



DUAL ARCH SYSTEM

J.E. ADAMS

- Allows easy access to claw and crevice tools
- Quick release hose couplers
- Stainless steel trash can holders
- Coolaroo architectural shade canopies (shown & optional)
- NOW AVAILABLE: LED light kits (6ft) and V-Shaped Canopies!

CALL CVS5200

CALL TO ORDER

VACUUMS & ACCESSORIES



J.E. ADAMS VACUUMS



Swivel Boom only.
Vacuum not included.



360° SWIVEL BOOM

J.E. ADAMS

- 110" from the back of the mounting plate to the tip of the arch
- Connects to most J.E. Adams Vacuums
- 1½" or 2" Vacuum hose for consumer & 2" hose inside the boom
- Quick disconnect hose to prevent theft
- Includes a claw hanger
- Mounting Plate is 16" x 16"
- Height of arches: 152"
- **180° STOPPER COMES STANDARD ON SWIVEL BOOMS**

PRICE	SWIVEL BOOM	COLOR
CALL	VBA75000B	Blue
	VBA75000R	Red
	VBA75000Y	Yellow
	VBA75000G	Green
ALSO AVAILABLE STAINLESS STEEL AND OTHER COLORS		
CALL	VBA75000-655	Add-on stopper. Must be purchased with 180° stopper for angles less than 180°

ARCH SYSTEM LIGHT KITS

J.E. ADAMS

VBA35000584A	4' LED Light, Fixed Vac Boom
35000-58HV-6	6' LED Light, Fixed Vac Boom
VBA35000588A	8' LED Light, Fixed Vac Boom
VBA350005980AS	LED Tube Light Power Supply Assembly

75000 SERIES ACCESSORIES

J.E. ADAMS

VBA75000-220	Swivel Arch Centering Kit
VBA75000-111A	Mat Rack Assembly
VBA75000-114A	Trash Can Assembly
VBA75000-140A	Trash Can Assembly, Stainless Steel Wrap

KIT FOR PUSH BUTTON WITH KEY SWITCH LOCKOUT

J.E. ADAMS

- Easily switch your coin operated-vac unit to a free vac unit!

CALL VAA9217-KSPBK

75000-2014A VACUUM MOUNTING KIT

J.E. ADAMS

- For use with 9217/9218/9237 series vacs on 75000 series poles

CALL VBA75000-2014A

COIN & BILL OPERATED 9218-DH SERIES

J.E. ADAMS

- Can be converted into single inlet with included coverplate

VAA9218-DH	Vac, Dual Inlet, SS Dome, Coin & Bill Operated
VAA9218LD-DH	Vac, Dual Inlet, Lighted Dome, Coin & Bill Operated

FREE PUSH BUTTON SERIES (9237-DH SERIES)

J.E. ADAMS

VAA9237-DH	Vac, Dual Inlet, SS Dome, Free Push Button
VAA9237LD-DH	Vac, Dual Inlet, Lighted Dome, Free Push Button

COIN OPERATED SERIES (9217-DH SERIES)

J.E. ADAMS

- Can be converted into single inlet with included coverplate

VAA9217-DH	Vac, Dual Inlet, SS Dome, Coin Operated
VAA9217LD-DH	Vac, Dual Inlet, Lighted Dome, Coin Operated

MOUNTED VACS FOR 35000 SERIES STANCHIONS

J.E. ADAMS

- **FREE PUSH BUTTON SPECIFICATIONS (9237):**
- (3) 1.6 HP, 120 volt motors - Requires 30 AMP service
- New lighted push-button start with timer
- Large stainless steel dome
- Double service doors offer easy access to clean-out area and 4 filter bag system
- **COIN OPERATED SPECIFICATIONS (9217):**
- (3) 1.6 HP, 120 volt motors - Requires 30 AMP service
- Double service doors offer easy access to clean-out area and 4 filter bag system
- Imonex coin acceptor takes quarters
- Coin box holds 940 quarters or \$235.00
- Coin box and faceplate secured with pin lock system
- 8712-JEA Proprietary Timer

VACUUMS & ACCESSORIES

J.E. ADAMS STACKED DUAL ARCH



New!



STACKED DUAL ARCH

J.E. ADAMS

STANDARD FEATURES PER STANCHION

- Stainless steel trash can holder
- Mat holder
- Stainless steel pre-filter collector
- claw & crevice tool
- 15-ft Black Hose(s)
- Quick release hose couplers
- 16.75" x 16.75" mounting plate (1" holes at 14" x14")

BENEFITS

- Easy access to claw & crevice tools
- Central vacuum/pole mounted vacuum compatible
- Extended canopy coverage

OPTIONS

- Stanchions available in Red, Yellow, Blue, Green, Orange, Gray, Black, or Stainless Steel
- Coolaroo architectural shade canopies (optional)
 - 12-ft stall spacing in either horizontal or 30° angle
 - Professional grade architectural shade fabric
 - Specialized lock-stitch knit allows for air flow
 - Resists sun damage
 - Blocks up to 98.8% of harmful UV sun rays

ACCESSORIES

- Colored hoses, LED lighting kits, pipe hanger kits additional security and more!

CALL TO ORDER

New!



VACUUM COVERED STALLS

J.E. ADAMS

STANDARD FEATURES

- Powder coated I-beam construction
- Steel roofing
- 12-ft center to center I-beam spacing
- 3-ft center of I-beam to edge of roof
- 16" x 16" mounting plate (1.25" holes at 12" x12")

BENEFITS

- Over 9-ft of roof coverage from center of column
- Integrated central vacuum plumbing mounts
- Pull thru or parallel parking configurations
- Permanent roofing structure
- Powder coated steel structure
- Central vacuum/pole mounted vacuum compatible

OPTIONS

- Main structure available in Red, Yellow, Blue, Green, Orange, Grey, or Black
 - Custom colors available upon request
- Trim and Soffit packages available.
- Custom Roof, Trim, and Soffit color options.
 - Trim and Soffit packages fitted by installer on site.
- Central vacuum plumbing integration kit
- 6-ft LED Lighting Kit

ACCESSORIES

- Stainless steel trash can holder, mat holder, stainless steel pre-filter collector, claw and crevice tool, quick release hose couplers, 6063 swivel boom, base covers

CALL TO ORDER



VACUUMS & ACCESSORIES



J.E. ADAMS VACS & VAC COMBO UNITS



ULTRA TURBO-NATOR® VACUUM

J.E. ADAMS

- **ALL ULTRA TURBO-NATOR VACUUMS REQUIRE 30 AMP SERVICE**
- Large Dixmor Digital Display Timer - highly visible and easy to read, scrolls messages, calculates time between functions, recalculates remaining time when switched during any function, and has a built-in coin counter
- Talos or Coinco Bill Acceptor and Imonex electronic coin acceptor
- Are available in a variety of dome and hose colors
- Many options and packages are available. Including free decal packages!
- 2 motor vacuum/3 motor turbo vacuum
- Lighted domes available
- Lighted push buttons
- Visual/audible last coin alert
- Medeco locks
- Weight: 250 lbs.

• **PLEASE REFER TO PART NUMBERS FOR SPECIFIC DETAILS ON EACH MODEL.**

CALL	VAA29025	WITH bill acceptor
	VAA29026	WITH bill acceptor, Vault ready
	VAA29027	WITHOUT bill acceptor

**ULTRA TURBO
POWERED VACUUM**

DECAL ONLY AVAILABLE IN BLACK



ULTRA 29070 SERIES COMBINATION VACUUMS

J.E. ADAMS

- Large Dixmor digital display timer is highly visible and easy to read, scrolls messages, calculates time between functions, recalculates remaining time when switched during any function, and has a built-in coin counter
- Imonex electronic coin acceptor takes U.S. \$1.00 coins, U.S. quarters, 1.073 and 0.984 tokens
- 6 lighted push buttons for the following functions: 2 motor vacuum, 3 motor turbo vacuum, shampoo/spot remover setting, and 3 fragrance selections
- Peninsula lighted dome available in red (standard), blue, yellow, and dark green
- Digital display can be easily programmed with remote control which is available at a nominal charge
- Hose: Black, 2" x 15', swivel cuff and nozzle included
- 2" x 15' hose available in red, blue, yellow, or green at no additional charge.
- Cut-resistant 1/4" x 25' wire braid air hose with 90 PSI inline air gauge
- Optional accessories available at an additional charge: electronic coin acceptors, quiet motors, vinyl clean-out bag, or rubber clean-out container, clean-out door lock kit
- 3 Motors with 2" hose = 210 Max CFM / 708 Peak Air Watts
- 3 Motors with 1 1/2" hose = 165.9 Max CFM / 708 Peak Air Watts
- (3) 1.6 HP, 120 volt motors
- GAST 3/4 HP air compressor
- Talos • bill acceptor takes \$1.00 and \$5.00 bills
- Comes with 7 Medeco plug locks
- Requires 30 AMP service
- Visual and audible last coin alarm
- Coin box holds 650 coins or \$165.00
- Includes a 3/8 Allen wrench for unlocking doors

CALL	VAA29070	WITH Bill Acceptor & Coin Acceptor
	VAA29071	Vault Ready, WITH Bill Acceptor & Coin Acceptor
	VAA29072	WITH Coin Acceptor
	VAA29073	Vault Ready, WITH Coin Acceptor

**ULTRA 29070 SERIES
VACUUMS ARE ETL & CETL
APPROVED**

THE MOST OPTIONS AVAILABLE IN THE INDUSTRY

Whether you are looking for a revenue generator or to stop replacing cheaper shop vacuums we've got options for you. J.E. Adams commercial vacuums (no-pay units) are great for car dealerships, rental car agencies, auto body shops, or as an option to give your customer base free vacuums at your wash. Revenue-generating models give you the options to use bills, quarters, or tokens.

VACUUMS & ACCESSORIES

J.E. ADAMS VACS & VAC COMBO UNITS



ULTRA TURBO-NATOR® HOT AIR DRYER COMBINATION VACUUM

J.E. ADAMS

- Turbo Towel is the first and only dryer on the market with heated air
- Use Turbo Towel to quickly dry off the exterior of your car, blast water out of cracks and crevices, and dry floor mats and carpets in a matter of minutes
- Nozzle velocity exceeds 200+ miles per hour
- Prevent scratches and marks caused by standard hand towel and chamois drying
- Talos bill acceptor takes \$1.00 and \$5.00 bills
- Imonex electronic coin acceptor takes U.S. \$1.00 coins, U.S. quarters, 1.073 and 0.984 tokens
- Comes with 7 Medeco locks (3 for the control doors, 1 for an internal bill acceptor locking box, 1 for an internal coin acceptor locking box) and 2 for turbo towel compartment
- Standard peninsula dome available in red, blue, yellow, and dark green
- Double service doors offer easy access to clean out compartment and 4 filter bag system
- Digital display can be easily programmed with optional remote control
- 3 lighted push buttons for the following functions: 2 motor vacuum, 3 motor turbo vacuum, and hot air dryer
- Includes a 2" x 30' high temperature hose for Turbo Towel and a 2" x 15" hose for the vacuum
- Large digital display timer is highly visible and easy to read, scrolls messages, calculates time between functions, recalculates remaining time when switched during any function, visual and audible last coin alarm, and has a built-in coin counter

TURBO TOWEL & ULTRA SERIES		
	VAA29050	WITH bill validator
CALL	VAA29050VR	WITH bill validator, vault ready
	VAA29051	WITHOUT bill validator
	VAA29051VR	WITHOUT bill validator, vault ready

**ULTRA TURBO
POWERED VACUUM**

TURBO TOWEL SUPER VACUUM		
	VAA9215LDV	WITH bill validator
CALL	VAA9215LD	WITHOUT bill validator
	VAA9215LD-VR	WITHOUT bill validator, vault ready



ULTRA TURBO-NATOR® TIRE SHINE COMBINATION VACUUM

J.E. ADAMS

- Comes with 1 gallon of Tire Shine formula. Dispenses 3/4 oz. in 30 seconds which is equal to 1.5 oz. of liquid formula. 1 gallon yields 85 minutes of vend time
- Large digital display timer is highly visible and easy to read, scrolls messages, calculates time between functions, recalculates remaining time when switched during any function, visual and audible last coin alarm, and has a built-in coin counter
- Comes with 7 Medeco Plug locks (3 for the control door, 1 for an internal bill acceptor locking box, 1 for an internal coin acceptor locking box, and 2 for tire shine formula compartment)
- Talos bill acceptor takes \$1.00 and \$5.00 bills
- Imonex electronic coin acceptor takes U.S. \$1.00 coins, U.S. quarters, 1.073 and 0.984 tokens
- Standard peninsula lighted dome available in red, blue, yellow, and dark green
- Round lighted dome available in red, blue, yellow, dark green, and white
- Double service doors offer easy access to clean out compartment and 4 filter bag system
- Hose: 2" x 15', swivel cuff and nozzle included (15', 25', and 50' available in 1 1/2" or 2")
- Optional coin mechs, motors, colored hoses, extra security, and clean-out containers are available
- Weight: 260 lbs

	VAA29035	WITH bill acceptor
CALL	VAA29036	WITH bill acceptor, vault ready
	VAA29037	WITHOUT bill acceptor

VACUUMS & ACCESSORIES



J.E. ADAMS VACS & VAC COMBO UNITS

**ULTRA
TURBO
POWERED
VACUUM**



**ULTRA
TURBO
POWERED
VACUUM**



**ULTRA
TURBO
POWERED
VACUUM**



ULTRA TURBO-NATOR® SHAMPOO & SPOT REMOVER COMBO VACUUM

J.E. ADAMS

- 2 motors/ 3 motor turbo vacuum
- Shampoo & spot remover
- 260 lbs.

CALL	VAA29000	WITH bill acceptor
	VAA29001	WITH bill acceptor - vault ready
	VAA29002	WITHOUT bill acceptor
	VAA29003	WITHOUT bill acceptor - vault ready



ULTRA TURBO-NATOR® FRAGRANCE COMBO VACUUM

J.E. ADAMS

- 2 motors/ 3 motor turbo vacuum
- Dispenses 3 different fragrances
- 260 lbs.

CALL	VAA29015	WITH bill acceptor
	VAA29016	WITH bill acceptor - vault ready
	VAA29017	WITHOUT bill acceptor
	VAA29018	WITHOUT bill acceptor - vault ready



ULTRA TURBO-NATOR® FRAGRANCE & SHAMPOO/SPOT REMOVER COMBO VAC

J.E. ADAMS

- 2 motors/ 3 motor turbo vacuum
- Fragrance & shampoo spot remover
- 298 lbs.

CALL	VAA29060	WITH bill acceptor
	VAA29061	WITH bill acceptor - vault ready
	VAA29062	WITHOUT bill acceptor
	VAA29063	WITHOUT bill acceptor - vault ready

Non-Returnable

Non-Returnable

Non-Returnable



J.E. ADAMS HAS THE WIDEST VARIETY OF COMBINATION UNITS IN THE MARKETPLACE.

Have multiple profit centers in one unit with the ability to charge different fees for different services. By having multiple services on one unit you save on space and our lighted domes and electronics will give your site a fresh look.

- Reliability, style, visual appeal
- Options your customers want

VACUUMS & ACCESSORIES

J.E. ADAMS SUPER VAC UNITS



VAA9200



VAULT READY VAA9200VR

SUPER VAC

J.E. ADAMS

FEATURES:

- 110 volt standard, 220 volt optional
- Secure coin box with pin lock
- Available with 2 motors
- 4 quick change filter bags
- Small stainless steel dome
- Takes quarters
- Easy installation
- 2-door canister
- **OPTIONS:** 8104 security kit for service doors, 8202W coin box security cover, 8206 lock bar, 9427K dual service door security cover, 6024 Abus lock, 8599 clean-out bag

SPECIFICATIONS:

- Input: 20 AMP, 120 VAC, 60 HZ
- Size: 19" diameter canister, 54½" H
- Shipping weight: 140 lbs
- Capacity: 2½ cubic feet
- Airflow: 2 motors with 2" hose, 163.5 CFM/193.4 Air Watts | 2 motors with 1½" hose, 140.8 CFM/402.4 Air Watts
- Optional 6-piece vinyl decal package. Yellow, blue or violet
- Optional colored hoses include red, blue, yellow, or green (black comes standard)

CALL	VAA9200	Standard
	VAA9200VR*	Vault Ready

BEST VALUE WORK HORSE VAC OFFERS CONVENIENCE & EASY MAINTENANCE

*ADA height box available upon request for vault ready vacuums



VAA9210

STAINLESS STEEL DOME



LIGHTED DOME

VAULT READY

VAA9210DVR

SUPER VAC - 2 MOTOR

J.E. ADAMS

- LIGHTED OR STAINLESS STEEL DOME AVAILABLE! • DELUXE DECAL PACKAGE NOT INCLUDED

STANDARD FEATURES:

- Two service doors
- Two 1.6 HP 120 volt motors
- Optional 8104 security kit for service doors, 8202W coin box security cover, 8206 lock bar, 9427K dual service door security cover, 6024 Abus lock, 8599 clean-out bag
- Mechanical coin acceptor takes quarters
- Optional 6-piece vinyl decal package in yellow, blue or violet
- Hose color options: red, blue, yellow, or green (black comes standard)
- Four quick-change filter bags
- Large stainless steel dome

CALL	VAA9210	2 Motors	Large Stainless Steel Dome
	VAA9210LD	2 Motors	Lighted Dome
	VAA9210LDVR*	2 Motors	Vault Ready - Lighted Dome

*ADA height box available upon request for vault ready vacuums

SUPER VAC - 3 MOTOR

J.E. ADAMS

- LIGHTED OR STAINLESS STEEL DOME AVAILABLE!

STANDARD FEATURES:

- Two service doors
- Three 1.6 HP 120 volt motors
- 210 CFM Max
- Lighted dome available in dark green, yellow, white, blue & red
- Hose color options: in red, blue, yellow, or green
- Optional 8104 security kit for service doors, 8202W coin box security cover, 8206 lock bar, 9427K dual service door security cover, 6024 Abus lock, 8599 clean-out bag
- Optional 6-piece vinyl decal package in yellow, blue or violet
- Four Quick Change filter bags
- Mechanical coin acceptor takes quarters

CALL	VAA9213VR*	3 Motors	Vault Ready - Stainless Steel Dome
	VAA9213	3 Motors	Stainless Steel Dome
	VAA9213LD-VR*	3 Motors	Vault Ready - Lighted Dome

*ADA height box available upon request for vault ready vacuums



LIGHTED DOME

VAA9213LD

STAINLESS STEEL DOME

VAULT READY

VAA9213VR



VACUUMS & ACCESSORIES



J.E. ADAMS SUPER VACUUMS AND COMBO MACHINES



SUPER VAC WITH BILL ACCEPTOR

J.E. ADAMS

- LIGHTED OR STAINLESS STEEL DOME AVAILABLE!

STANDARD FEATURES:

- Optional 8104 security kit for service doors, 8202W coin box security cover, 8206 lock bar, 9427K dual service door security cover (shown), 6024 Abus lock, 8599 clean out bag
- Optional 6-piece vinyl decal package available in 11 series yellow, 12 series blue, 13 series violet
- Dome color options: Dark green, yellow, white, blue, and red
- Secure coin box with pin lock
- Hose color options: Red, blue, yellow, or green (black comes standard)
- Talos \$1 & \$5 bill acceptor
- 2 door canisters, takes quarters
- 1.6 HP, 120 volt motors
- 4 quick-change filter bags

CALL	VAA9209-6	3 Motors	Large Stainless Steel Dome
	VAA9209	2 Motors	Small Stainless Steel Dome
	VAA9209LD	2 Motors	Lighted Dome
	VAA9209-6LD	3 Motors	Lighted Dome



SUPER VAC WITH LIGHTED DISPLAY TIMER & BILL ACCEPTOR

J.E. ADAMS

- LIGHTED OR STAINLESS STEEL DOME AVAILABLE!

STANDARD FEATURES:

- Stainless steel or colored lighted dome available in dark green, red, yellow, blue, red, or white
- Optional 8104 security kit for service doors, 8202W coinbox security cover (shown), 8206 lock bar (shown), 9427K dual service door security cover (shown), 6024 Abus lock (shown), 8599 clean-out bag.
- Optional 6-piece vinyl decal package: Yellow, blue, violet
- Hose color options: Red, blue, yellow, or green (black comes standard)
- Talos \$1 & \$5 Bill Acceptor
- Dixmor Digital Display
- Last coin lamp & alarm
- Imonex Coin acceptor
- 2-door canister
- 4 quick-change filter bags
- 1.6 HP 120 volt motors
- Secure coin box w/pin lock

CALL	VAA9200-1LD	2 Motors	Lighted Dome
	VAA9200-1		Small Stainless Steel Dome
	VAA9200-3	3 Motors	Large Stainless Steel Dome
	VAA9200-3LD		Lighted Dome



VAC/AIR COMBO

J.E. ADAMS

STANDARD FEATURES:

- (2) 1.6 HP, 120 volt motors
- Requires (1) 20 AMP services

CHOOSE:

- 2 motors with 2" hose=163.5 CFM /532.5 Peak Air Watts
- 2 motors with 1.5" hose=140.8 CFM /532.5 Peak Air Watts
- 3/4 HP oil-less GAST air compressor, 18-month warranty
- Comes with 4 Medeco locks (3 for the control door, 1 for an internal coin acceptor locking box - digital models only)
- (2) service doors, 4-quick-change filter bags
- Hose: 2" x 15', swivel cuff and nozzle included
- Pin locks on standard units
- Imonex coin mechanisms takes quarters only
- Pressure range 4-70 psi (accuracy +/- .5 PSI)
- 25' air hose with 90 PSI air gauge
- Temperature safe from -20° F to 158° F
- Built-in unit heater(digital model only)
- Electronic pressure relief valve (digital model only)
- Automatic compressor shut off

DIGITAL FEATURES:

- Inflate and deflate tires with the push of a button
- Easy to read LCD backlit display shows price for service and amount of remaining money needed
- Set desired tire pressure with (+) and (-) touch buttons

CALL	VAA9420-1GDIGP	Digital Air & Vac Gast Compressor
	VAA9420-1DIGPV	Digital Air & Vac with Bill Acceptor
	VAA9420G	Vac & Air, Gast compressor

MUST CHOOSE DOME COLOR WHEN ORDERING



VAC/AIR COMBO

J.E. ADAMS

STANDARD FEATURES:

- (2) 110 volt non-accumulating timers
- Two service doors
- Four quick-change filter bags
- Two 1.6 HP 120 volt motors
- Side-mounted retractable air hose reel
- 25' air hose with 90 PSI air gauge
- 2 mechanical coin acceptors take quarters
- Optional 8104 security kit for service doors, 8202W coin box security cover, 8206 lock bar, 9427K dual service door security cover, 6024 Abus lock, 8599 clean-out bag
- Hose color options: Red, blue, yellow, green (black comes standard)
- Requires 2 electrical services

CALL VAA9420H

RETRACTABLE HOSE REEL BASE



NON-DIGITAL

VACUUMS & ACCESSORIES

J.E. ADAMS SUPER VACUUMS AND COMBO MACHINES



LIGHTED DOME



DUAL VAC WITH LIGHTED DOME

J.E. ADAMS

STANDARD FEATURES:

- Central service & control compartments are common to both vacs, making installation/service easy
- Redesigned large capacity coin box secured with an Abus lock (6024), & holds over \$417 in quarters
- 4 service doors for easy maintenance
- 2-in-1, save island space & maximize profits!
- 4 quick change filter bags
- Optional bill acceptor on one side or both (shown)
- 4 - 1.6HP, 120 volt Ametek motors
- 1½" hoses available
- Dome color options: green, yellow, blue and red
- 2 plastic clean-out bins included
- Hose color options: Red, blue, yellow, or green (black comes standard)

DESIGNED FOR MAXIMUM SECURITY

CALL	VAA8960	4 Motors	Lighted Dome
	VAA8960C		Commercial - Lighted Dome
	VAA8970		Vault Ready - Lighted Dome

VAC/SHAMPOO COMBO

J.E. ADAMS

STANDARD FEATURES:

- Imonex electronic coin acceptor takes U.S. \$1.00 coins, U.S. quarters, 1.073 & 0.984 tokens
- Displays messages, prices for service, counts down time and recalculates time if toggled mid cycle
- Toggle switch on faceplate selects vac or shampoo/spot remover
- Rocker switch on brush to select shampoo/spot remover
- Four Quick Change filter bags
- Two 1.6 HP 110 volt motors
- Twin cam lock for faceplate & shampoo box
- Last coin lamp & alarm
- Pin lock style coin box, & coin box security cover with lock bar (optional)
- Lighted dome: dark green, yellow, white, blue & red
- Hose color: Red, blue, or yellow, (black is standard)
- Optional security kit for service door (8104), coin box security cover (8202W), lock bar (8206), Abus lock (6024), clean-out bag (8599), 9427K dual service door security cover
- 1 oz. of shampoo/remover makes 2.5 gal. of foam

SHOWN WITH OPTIONAL BLUE DOME, HOSE, 8202W, 8206, & 6024 COIN BOX SECURITY PACKAGE

CALL	VAA9500BA	WITH Talos Bill Acceptor
	VAA9500	WITHOUT Bill Acceptor

VAC SCENTSATIONS WITH BILL ACCEPTOR

J.E. ADAMS

STANDARD FEATURES:

- Talos \$1 & \$5 Bill Acceptor
- Two 1.6HP 110 volt motors
- 4 filter bags
- Twin cam locks for faceplate
- Pin lock coin box
- Choice of 3 fragrances
- Toggle switch between vac & fragrance
- Last coin lamp & alarm

- Lighted dome available in dark green, yellow, white, blue & red
- Imonex electronic coin acceptor takes U.S. \$1.00 coins, U.S. quarters, 1.073 and 0.984 tokens
- Timers with digital display scroll messages, prices for service - counts down time and recalculates time if toggled mid cycle
- Hose color options: Red (shown), blue, yellow, or green (black comes standard)
- Optional security kit for service door (8104), coin box security cover (8202W), lock bar (8206), Abus lock (6024), clean-out bag (8599), 9427K dual service door security cover

CALL	VAA8900BA	WITH Bill Acceptor
	VAA8900	WITHOUT Bill Acceptor



VAA9225



VAA9235-3DH

THESE COMMERCIAL VACUUMS DO NOT COME WITH A COINBOX

COMMERCIAL VACUUMS

J.E. ADAMS

- LIGHTED OR STAINLESS STEEL DOME AVAILABLE!

STANDARD FEATURES:

- Additional optional timers, motors, colored hoses, clean-out bag
- 4 Quick Change filter bags
- On/off toggle switch
- 1.6 HP 120 volt motors
- Optional push button on/off timer
- Two service doors
- Lighted dome available

CALL	VAA9235	2 Motors	Large Stainless Steel Dome
	VAA9235-3	3 Motors	Large Stainless Steel Dome
	VAA9235-3DH	3 Motors	2 Hoses - Stainless Steel Dome
	VAA9225	2 Motors	Small Stainless Dome

SINGLE MOTOR MINI VAC

J.E. ADAMS

Push-button model is ideal for lighter duty applications

STANDARD FEATURES:

- Single 120V motor with 2" hose
- Drop bottom clean out for hands free cleaning
- Single service door with single pleated cartridge filter
- Wall mount or post mount
- Coin-operated (9299) and free model (9299C) available
- Imonex coin acceptor takes quarters (8149)
- 110 volt accumulating timer (8712SS4)
- Coin box holds 630 quarters or \$158
- Standard 2" x 15' hose with swivel cuff and claw nozzle included
- 129.8 CFM max, 633 air Watts
- 132" of water lift

CALL	VAA9299	Coin Operated
	VAA9299C	Push Button



SHOWN WITH OPTIONAL RED DOME, HOSE, 8202W, 8206, & 6024 COIN BOX SECURITY PACKAGE

VACUUMS & ACCESSORIES



J.E. ADAMS VACUUMS

**SUPER
VAC**

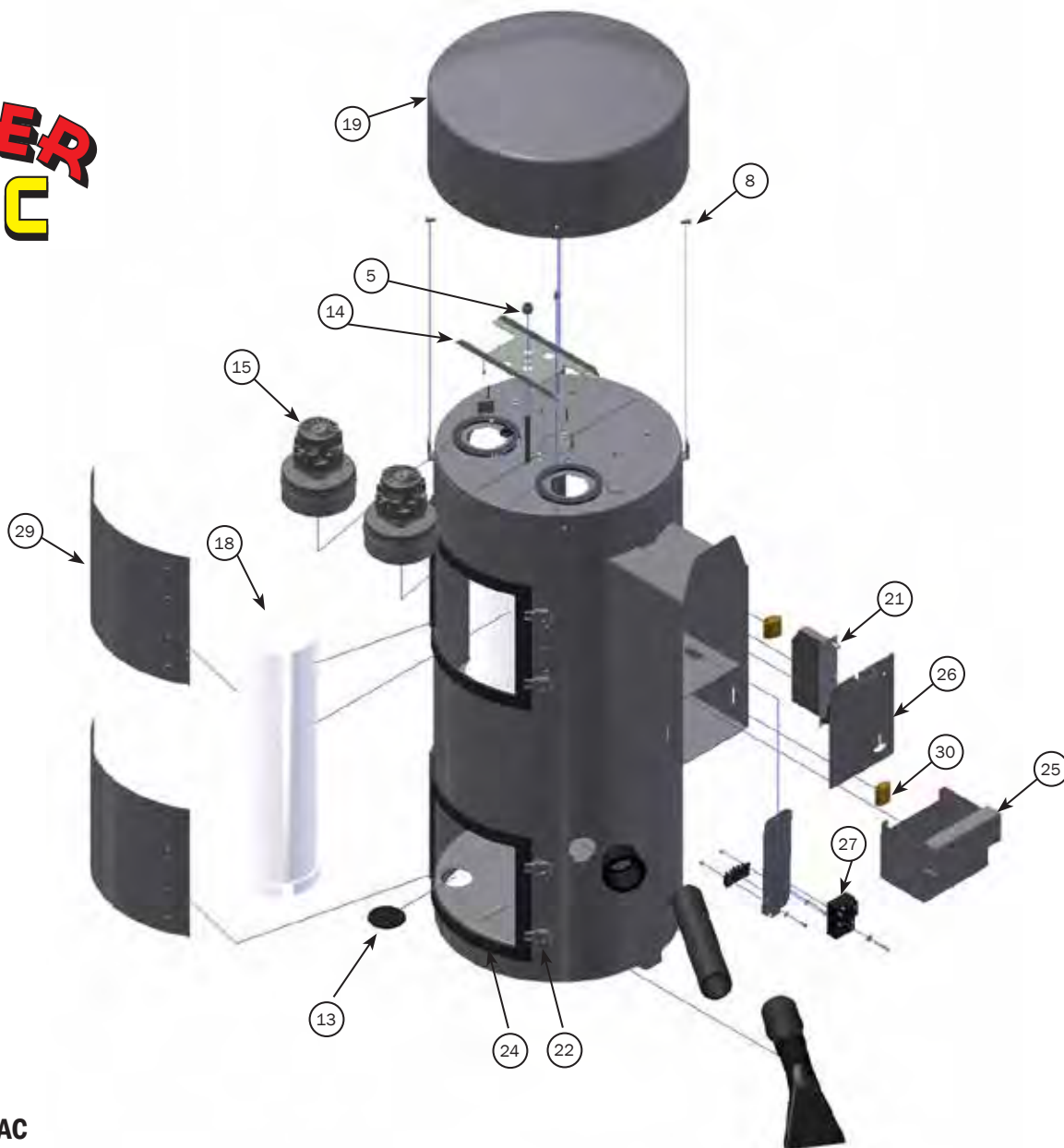

9200 SUPER VAC

J.E. ADAMS

• PLEASE NOTE THAT PART NUMBERS MARKED WITH A "*" AND "SPECIAL/CALL" ARE SPECIAL ORDER ITEMS. PLEASE GIVE US A CALL TO DISCUSS PRICING AND SHIPPING TIMES.

1	VAK45BK	2" x 15' Black Vac Hose (Other Colors Available)	\$28.57
2	VAB-20B	2" Black Vac Nozzle (Other Colors Available)	\$2.15
3	5600D4*	3/8-16 x 1.5 HHCS	CALL
4	D5603D11*	10 Standard NC Nylock Nut	
5	5603D11*	1/2 Standard NC Nylock Nut	CALL
6	5606D22*	Washer, 3/8 Fender	
7	5606D7*	Flat Washer, .160 ID x .500 OD	\$0.99
8	VA40017	Stainless Steel Allen Screw for Dome	
9	5627D2*	Pan Head, Slotted, 6-32 x 5/8	CALL
10	VAA5629D2	#8 x 1/2" Self Tapping Screw	\$0.10
11	VAA5639D6	Rubber Grommet	\$1.34
12	5871B9*	Plastic Vac Lid Plug	CALL
13	VAA5871B8	Plastic Plug Screw Cover	\$1.75
14	VAA8051	H Bracket Adams Vac Motor Hold	\$26.49
15	VMK19	Kleen-Rite Vac Motor	\$36.50
16	8055LEAD-EM*	Wire Lead, EM Vac Motor	CALL

17	VA40020	Kleen-Rite Vac Motor Gasket	\$1.25
18	VAA8074	Filter Bag for 9200 Vac	\$19.19
19	VA40015	20" Stainless Steel Vac Dome	\$255.77
20	8108*	#10 x 1/2 Tap Screw	CALL
21	IMZ3Q	2" Imonex Coin Mech - U.S. Quarters	\$52.77
22	VA40028	Kleen-Rite Vac Door - Clasp/Hinge ONLY	\$6.98
23	VAA8157	Nut for Door Latch	\$0.20
24	VAA8159	Door Gasket	\$4.93
25	CBA8204	Money Box - Pin Lock Style	\$95.16
26	CBA8211	Face Plate - Pinlock	\$66.67
27	VEA871214-120	120V Non-Accumulating Vacuum Timer	\$54.75
28	8605*	Pallet, Vac, 26" x 30.5"	CALL
29	VAA8615-5W	Clean-Out Door with Hinges	\$77.53
30	LOA250	Adams Pin Lock With Pin	\$25.18
31	8673-11*	Ground Wire 28"	CALL
32	9201W*	Can W/C 2DRVAC Econo/Pin	
33	B5722-002*	Nut, 3/8-16 UNC Hex Lock Nut	

VACUUMS & ACCESSORIES

J.E. ADAMS VACUUMS



**SUPER
VAC**

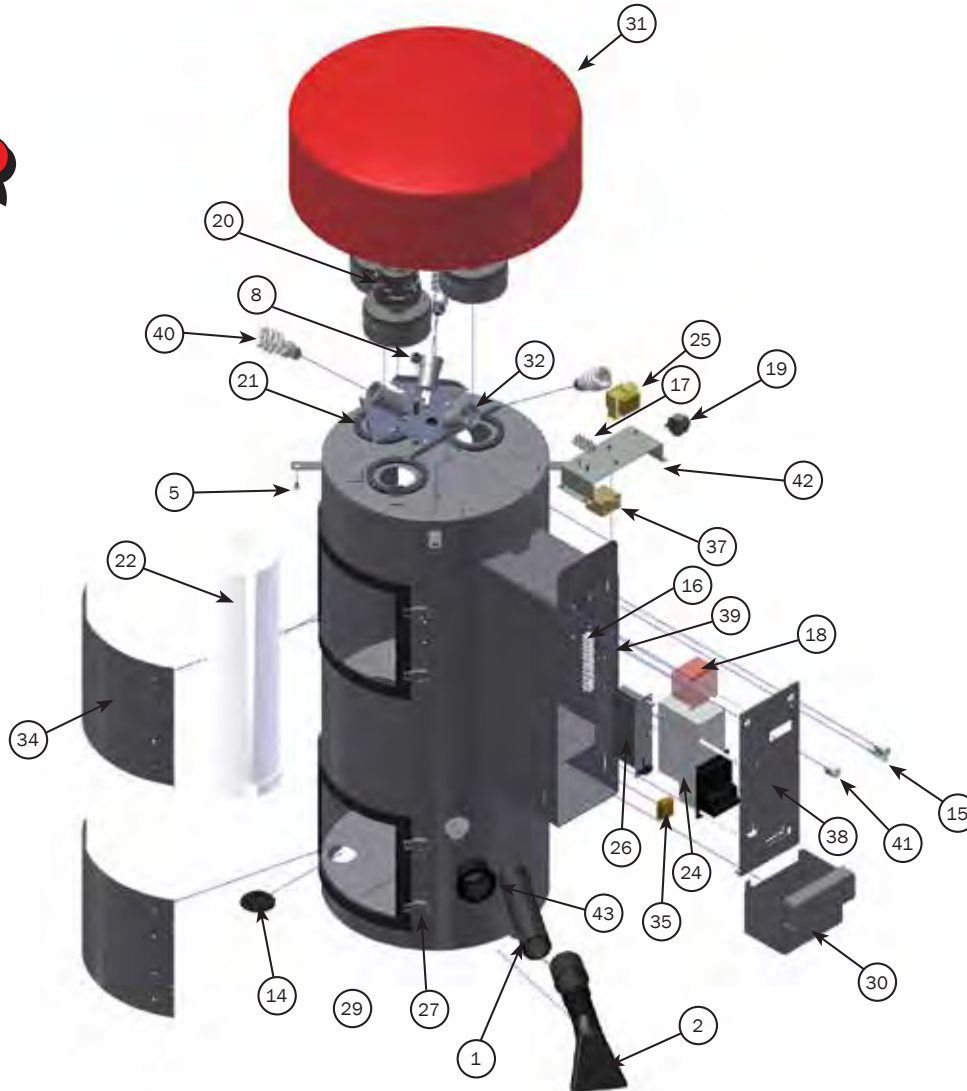

9200-3LD SUPER VAC

J.E. ADAMS

• PLEASE NOTE THAT PART NUMBERS MARKED WITH A "*" AND "SPECIAL/CALL" ARE SPECIAL ORDER ITEMS. PLEASE GIVE US A CALL TO DISCUSS PRICING AND SHIPPING TIMES.

1	VAK45BK	2" x 15' Black Vac Hose (Other Colors Available)	\$28.57	
2	VAB-20B	2" Black Vac Nozzle (Other Colors Available)	\$2.15	
3	VAA5000D5*	Stand Off	CALL	
4	5600D4*	3/8-16 x 1.5 HHCS		
5	5601D13*	SCR, 1/4-20 x 1/2 PPHSq ConeStepZP		
6	D5603D1*	10 Std NC Nylock Nut		
7	VAA5603D10*	6 Std NC Nylock Nut		
8	5603D11*	1/2 Std NC Nylock Nut		
9	5606D22*	Washer, 3/8" Fender		
10	5606D7*	Flat Washer, .160 ID x .500 OD		
11	5627D1*	Pan Head, Slotted, 6-32 x 1		
12	5627D2*	Pan Head, Slotted, 6-32 x 5/8		
13	VAA5662D2	6-32 x 1/2 Phillips Pan Machine Screw		\$0.17
14	VAA5871B8	Plug, Vac Bottom 2 1/2"		\$1.75
15	VAA5913D8	Lamp, Panel Mount, 3/8, 12V, LED Grn		\$7.84
16	VAA5944D001	Terminal Strip, 12 Poles, 8 Amp Max		\$16.43
17	VAA5944D004	Terminal Strip, C-60 Series, 4 Pole	\$5.40	
18	CB0316	Dixmor Display Timer	\$262.87	
19	CB0319	Alarm, Last Coin Alert	\$10.27	
20	VMK19	Kleen-Rite Vac Motor	\$36.50	
21	VA40020	Motor Gasket	\$1.25	
22	VAA8074	Filter Bag for 9200 Vac	\$19.19	

23	8108*	#10 x 1/2 Tap Screw	CALL
24	T6T1-U5E	CPI Talos 110V Validator	\$507.43
25	VAA8131-2	Transformer	\$33.31
26	IMZ3Q	2" Imonex Coin Mech - US Quarters	\$52.77
27	VA40028	Vac Door Clasp/Hinge Only	\$6.98
28	VAA8157	Nut for Door Latch	\$0.20
29	VA8159	Vac Door Gasket	\$4.93
30	CBA8204	Money Box - Pin Lock Style	\$95.16
31	VAA8306	Plastic Vac Dome - Specify Color	\$139.44
32	8543K-3*	3 Motor Light Kit	CALL
33	8605*	Pallet, Vac, 26" x 30.5"	CALL
34	VAA8615-5W	Clean Out Door with Hinges	\$77.53
35	LOA250	Adams Pin Lock with Pin	\$25.18
31	8673-11*	Ground Wire 28"	CALL
37	VAA876124	Relay, 3PDT, 24V AC, 30 Amp	\$77.69
38	VAA89007VW	Face Plate	\$83.08
39	VAA890082	Terminal Bracket, Vac-Scent	\$18.62
40	VAA5911D1	Fluorescent Bulb	\$6.30
41	LOA8953	Medeco Cam Lock with 1 Key	\$62.35
42	VAA9200-10	Bracket, 9200 with Validator	\$9.69
43	9201W6*	Canister Weldment, Bill Acceptor, 3M	CALL
44	B5722-002*	Nut, 3/8-16 UNC Hex Lock Nut	CALL

ALL PRICES ARE F.O.B. AND ARE SUBJECT TO CHANGE WITHOUT NOTICE • NO C.O.D.'S

1-800-233-3873 • (717) 684-6721 • FAX (800) 446-0495 • KLEENRITE.COM

299

VACUUMS & ACCESSORIES



J.E. ADAMS VACUUMS

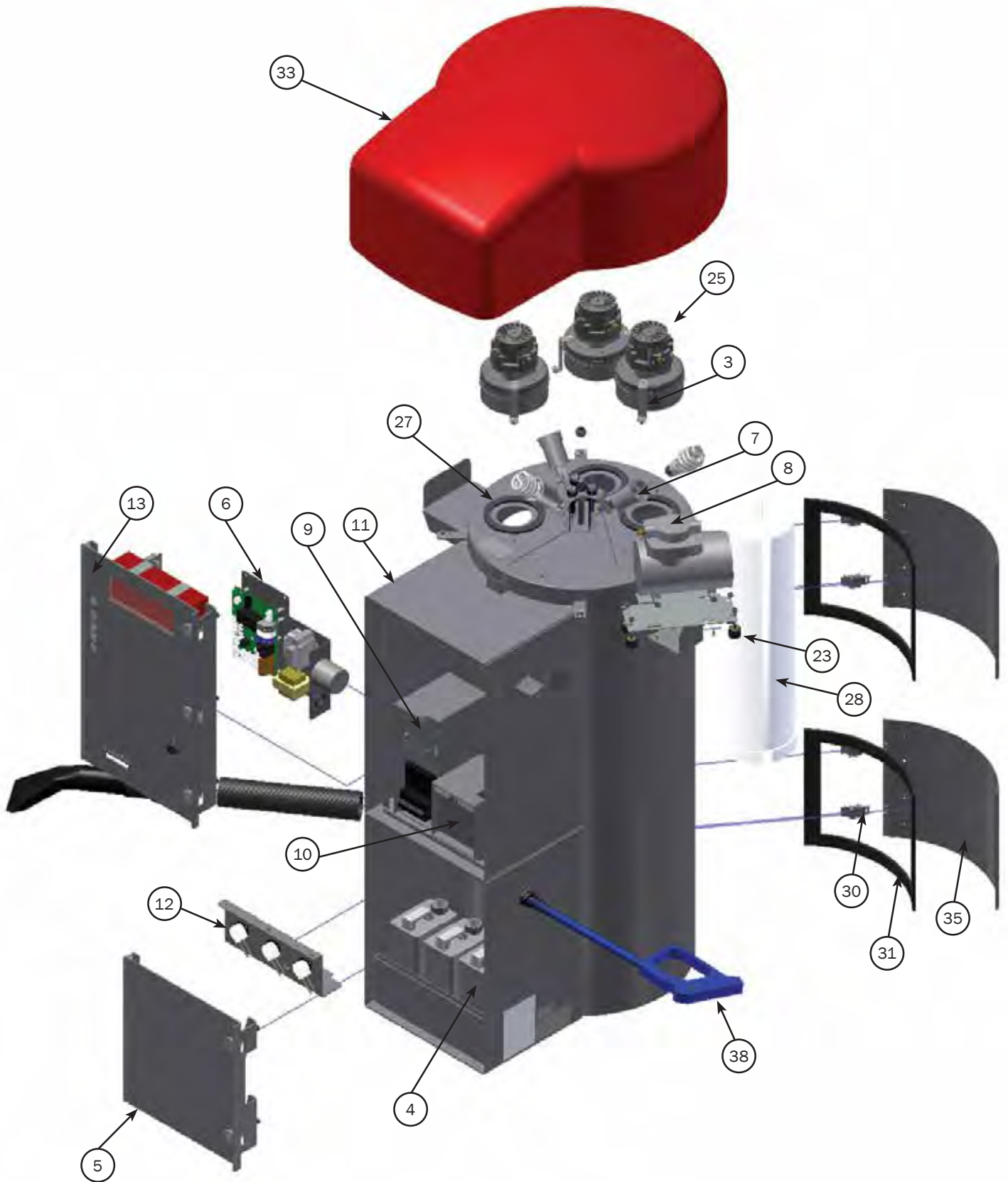

29015 ULTRA SERIES VACUUM/FRAGRANCE
J.E. ADAMS

VACUUMS & ACCESSORIES

J.E. ADAMS PARTS & ACCESSORIES



29015 ULTRA SERIES VACUUM/FRAGRANCE

J.E. ADAMS

• PLEASE NOTE THAT PART NUMBERS MARKED WITH A "*" AND "SPECIAL/CALL" ARE SPECIAL ORDER ITEMS.



BRUSH ASSEMBLY
VACUUM PARTS

- Use the J.E. Adams 8549-1 Flex Strain Relief to connect this brush assembly to your unit
- VEA8549-1 sold separately

\$368.77 VEA11000-15



GUN & HOSE ASSEMBLY
VACUUM PARTS

\$271.45 VEA8898 (Before 2005)
\$293.40 VEA8898-1 (2005 and After)



SILVER PUSH BUTTON
VACUUM PARTS

\$89.81 VAA00CBD05



RED PUSH BUTTON
VACUUM PARTS

\$85.51 VAA2000072A

OLD STYLE



AC PUSH BUTTON
VACUUM PARTS

\$18.30 VAA8726



PUSH BUTTON LIGHT
VACUUM PARTS

\$1.88 VAA20000-74

OLD STYLE



FUSE HOLDER
VACUUM PARTS

\$4.42 VAAB5997001



10 AMP FUSE
VACUUM PARTS

\$3.04 VAAB5996010



1/2 GALLON JUG
VACUUM PARTS

\$4.07 VAA28000-40



PERISTALTIC PUMP
VACUUM PARTS

\$127.24 VAA950043



CIRCUIT BOARD
FOR PERISTALTIC PUMPS

\$95.28 VAA5001

1	VAK45BK	2" x 15' Black Vac Hose (Other Colors Available)	\$28.57
2	VAB-20B	2" Black Vac Nozzle (Other Colors Available)	\$2.15
3	VAA28000-36	Motor Mount	\$5.23
4	VAA28000-40	1/2 Gallon Jug	\$4.07
5	29000-14A-1*	Door Assembly, Bottom, Plug Lock	
6	29000-250A*	Control Panel Assembly W/ CB	
7	VAA29000-30A*	Light Bracket Assembly	
8	29000-37A*	Compressor Assembly	
9	29000-44A*	Bill Acceptor Assembly, Plug Lock	
10	29000-47A*	Coin Box Assembly, Plug Lock	
11	29015-1W-2*	Canister Weld Complete, Scent/Plug Locks	CALL
12	29015-29A-2*	Thomas Pump Assembly	
13	VAA290157CBA-1*	Scent Vac Door Assembly, Coinbox/Plug Locks	
14	5600D4*	3/8-16 x 1.5 HHCS	
15	VAA5601D13*	SCR, 1/4-20 x 1/2 PPHSqConeStepZP	
16	5603D11*	1/2 Std NC Nylock Nut	
17	VAA5639D9*	1/4 Std NC Nylock Nut	
18	VAA5603D5	Nut for Plug	\$0.16
19	5606D10*	Washer, Flat 1/2 SAE	
20	5606D22*	Washer, 3/8" Fender	CALL
21	5611D4*	Nut, 5/16"-18 UNC KEPP-SS	

22	5639D4*	Rubber Grommet	
23	VAA5639D9*	Isolation Mount, 30 DUR Neoprene, 1/4-20	CALL
24	VAA5871B8	Plastic Plug Screw Cover	\$1.75
25	VAL9414	Motor Ametek	\$46.08
26	VMK19	Kleen-Rite Vacuum Motor	\$36.50
27	VA40020	Kleen-Rite Vac Motor Gasket	\$1.25
28	VAA8074	Filter Bag	\$19.19
29	8108*	#10 x 1/2 Tap Screw	CALL
30	VA40028	Kleen-Rite Door Clasp/Hinge Only	\$6.98
31	VA8159	Vac Door Gasket	\$4.93
32	DEA8183	Warning Decal	\$0.40
33	VAA8308R*	Peninsula Dome	
34	8467D001*	ETL Decal, Vacuum	CALL
35	VAA8615-5W	Clean Out Door with Hinges	\$77.53
36	8732*	Nameplate Serial Tag, UL	
37	8754*	Decal, Danger, Tri-Ling	CALL
38	VEA8898-1	Scent Gun Assembly with 15' Hose	\$293.40
39	VAA5911D1	60W Bulb for Lighted Domes	\$6.30
40	8939*	Pallet, Dual, Oval, Speciality, 30" x 40"	CALL
41	B5722-002*	Nut, 3/8-16 UNC Hex Lock Nut	CALL

VACUUMS & ACCESSORIES



J.E. ADAMS PARTS & ACCESSORIES

ULTRA SERIES VACUUM/FRAGRANCE J.E. ADAMS



FOR SHAMPOO/
SPOT
REMOVER

BRUSH HEAD DECAL
VACUUM PARTS

\$2.43 DEA11000-15D



CLEAN OUT BAG
VACUUM PARTS

\$72.77 VAA8599



PLASTIC PLUG SCREW COVER
VACUUM PARTS

\$1.75 VAA5871B8



OLD
STYLE

RELAY FOR 2 MOTOR VAC
VACUUM PARTS

\$67.78 VAA8760



OLD
STYLE

RELAY FOR 3 MOTOR VAC
VACUUM PARTS

\$106.61 VAA8761110

ULTRA TURBONATOR® REPLACEMENT PARTS

J.E. ADAMS

- These parts will work with the Ultra Turbonator Vacuum, Shampoo & Spot Remover Combo and Fragrance Combo

\$507.43	T6T1-U5E	CPI Talos 110V Validator
\$3.80	VAA8843	Polypropylene Filter Screen
\$443.70	DM9MF	Dixmor Multi-Function LED 9 Timer
\$33.99	DM5R	Remote For Dixmor Timer
\$6.30	VAA5911D1	Fluorescent Bulb
\$213.20	IM208	Imonex Electronic Coin Acceptor



**MEDECO SCREW LOCK
INTERNAL LOCKS
(BIIL ACCEPTOR & COIN BOX)**
VACUUM PARTS

\$57.28 L00145



**MEDECO 2" EXTERNAL
SCREW LOCK**
VACUUM PARTS

\$59.35 VAA89582

ULTRA TURBONATOR® FRAGRANCE COMBO ONLY REPLACEMENT DECALS

J.E. ADAMS



\$1.54	VAA8435-5	Decal, List of Fragrances
\$118.88	DEA29015B-KIT1	Push Button Decal Set - Blue
\$127.11	DEA29015-KIT1	Push Button Decal Set - Black



IMONEX COIN ACCEPTOR
VACUUM PARTS

\$213.20 IM208

DOOR
GASKET

MOTOR
GASKET



VAC DOOR & MOTOR GASKETS
VACUUM PARTS

\$4.93 VA8159 Door Gasket
\$1.25 VA40020 Motor Gasket

ULTRA TURBONATOR® SHAMPOO & SPOT REMOVER COMBO ONLY REPLACEMENT DECALS

J.E. ADAMS

\$146.05	DEA29000Y-KIT	Decal Set - Yellow
\$109.71	DEA29000B-KIT	Decal Set - Blue
\$117.54	DEA29000-KIT	Decal Set - Black

VACUUMS & ACCESSORIES

J.E. ADAMS PARTS & ACCESSORIES



VACUUM PEDESTAL

J.E. ADAMS

- Stainless steel vacuum base for J.E. Adams 9200 vacuums. Stand only.
- Does not include conduit or vault
- 30" D x 20" T
- Includes mounting studs to secure vacuum to base

CALL VAA32000-40A



VACUUM PEDESTAL FORMS

J.E. ADAMS

Includes:

- Regular: 30" D X 20" T Sono-Tube
- Large: 36" D X 20" T Sono-Tube
- Framing for Vac Mounting Studs
- PVC Conduit and Junction Box
- Concrete NOT Included
- Designed for use with J.E. Adams 9200 Series Vacuums Round Stainless Steel Pedestal

CALL VAA32000-30A Regular Form
VAA32000-31A Large Form



WELD PIN FOR COIN BOX

VACUUM PARTS

\$6.65 CBA8205



SELECTION BULB FOR ADAMS FRAGRANCE/VAC BLUE LED

VACUUM PARTS

\$9.64 VAA5913D10



ROCKER SWITCH (OLD STYLE, SCREW ON TERMINAL)

VACUUM PARTS

\$33.77 VEA1100051



INLET TUBE FOR VAC HOSE

VACUUM PARTS

\$2.44 VAA86157



ABUS DISKUS LOCK FOR 8202W & 8940-1W COIN BOX SECURITY COVERS

VACUUM PARTS

\$23.61 L00105



FOR ADAMS FRAGRANCE UNITS

ROCKER SWITCH (NEW STYLE, PUSH ON TERMINALS)

VACUUM PARTS

\$12.36 VEA11000-55



Replaces CB-5002

CIRCUIT BOARDS FOR PERISTALTIC PUMP

VACUUM PARTS

\$564.19 VAA5003RW1



120 VOLT ACCUMULATING VACUUM TIMER

VACUUM PARTS

\$54.75 VEA8712I4-120

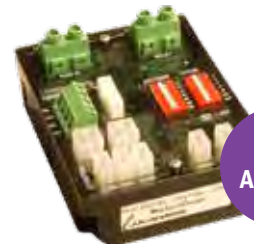

FOR ADAMS

MASTER COUNT TIMER

VACUUM PARTS

\$155.41 VAA8712-JEA



FACE PLATE FOR ADAMS 8200 & 9200 PIN LOCK

VACUUM PARTS

\$66.67 CBA8211



FACE PLATE (OLD STYLE) FOR ADAMS 8200, 8300 & 8500

VACUUM PARTS

\$23.69 VA40024



<https://www.jeadams.com/>

VACUUMS & ACCESSORIES



J.E. ADAMS PARTS & ACCESSORIES

COIN BOX SECURITY COVER

J.E. ADAMS MACHINE PARTS

- **COIN BOX SECURITY COVER OPTION FITS:**
- 8940-1W fits models: 8930, 8940, 9220, 9230, 9240, 9250, 9253
- 8202W fits models: 8200 series, 8600 series, 8648 series, 9200 series, 9200-1 series, 9200-3 series, 9200-4 series, 9200-5 series, 9209 series, 9210 series, 9213 series and 9420 series

\$93.48 CBA8202



COIN BOX FOR ADAMS 9200 PIN LOCK

J.E. ADAMS MACHINE PARTS

\$95.16 CBA8204

LOCK BAR KLEEN-RITE J.E. ADAMS OLD STYLE

J.E. ADAMS MACHINE PARTS

\$13.23 VA40025R



ALLEN SCREW

VAC SUPPLIES & PARTS

- For Kleen-Rite Vac Dome

\$0.99 VA40017



MOUNTING ADAPTER

VAC SUPPLIES & PARTS

- For 24" domes

\$8.88 VAA9900056



LOCK BAR - (1" INSIDE)

J.E. ADAMS MACHINE PARTS

\$44.70 VA40025



LOCK BAR FOR 8202W & 8940-1W COIN BOX

J.E. ADAMS MACHINE PARTS

- Security covers 1½" x ¼" x 9"

\$28.70 CBA8206

SECURITY KIT FOR SERVICE DOORS

J.E. ADAMS MACHINE PARTS

- 1 kit is needed for each service door

\$44.09 VAA8104



LARGE DOME MOUNTING KIT

VAC SUPPLIES & PARTS

Includes:

- (4) Screws - 1/4-20 x 3/4 Hex Socket Head, Stainless Steel
- (4) Nuts - 1/4-20 Jam Nut, Stainless Steel
- (4) Nuts - 1/4-20 Kepp Nut, Stainless Steel
- (4) Washers - Flat 1/4", Stainless Steel
- (4) Washers - Thick, Nylon

\$24.38 VAA8307



DEA84294



DEA920014



DEA84302

**** DOME DECALS NOT INCLUDED**

J.E. ADAMS DECALS

DECALS

PRICE	PART #	DESCRIPTION
\$2.82	DEA8173	Deposit quarters slowly
\$4.31	DEA84232	Dome Decal
\$21.37	DEA84251	Dual Vac/lower canister
\$14.85	DEA84252	Dual Vac/upper canister
\$23.58	DEA84271	Air/Vac tank vac only
\$25.30	DEA84272	Air/Vac tank air only
\$22.27	DEA84273	Air/Vac Dome front
\$36.06	DEA84301	Air machine door

PRICE	PART #	DESCRIPTION
\$8.31	DEA84302	Side Decal air machine
\$12.79	DEA9200FPD	Faceplate Decal w/ Prices
\$2.60	DEA84293	Vac Decal .50¢
\$2.76	DEA85671	Vac Decal .75¢
\$100.18	DEA920012	**Blue Super Vac
\$102.18	DEA920011	**Yellow Super Vac
\$105.59	DEA920013	**Violet Super Vac

PRICE	PART #	DESCRIPTION
\$60.29	DEA920014	Decal Kit for 9200, 9210, 9213 - Includes 1 of each: 9200FPD faceplate decal, 8423-2 dome decal, 8427-1 canister decal (*NOW MEASURES 28" X 11"), 8429-1 "Hang Hose Here" decal

SECURITY COVER SERVICE DOOR

J.E. ADAMS MACHINE PARTS

- **FACTORY INSTALLED ON NEW VAC ORDERS ONLY! THIS ITEM CANNOT BE INSTALLED IN THE FIELD!**
- Accommodates all J.E. Adams round 2 door vacuums, air/vacuums, air/water vacuums, & 2 door combo units.
- Includes Medeco lock
- Dimensions: 3.5"W x 40.5"H x 1.5"D

\$156.28 VAA9427K



OPTIONAL DOMES

J.E. ADAMS MACHINE PARTS

\$139.44	VAA8306B	Blue
\$140.24	VAA8306DG	Dark Green
\$140.24	VAA8306N	Natural
\$140.24	VAA8306R	Red
\$140.24	VAA8306Y	Yellow
\$432.93	VAA8305	24" Stainless
\$255.77	VA40015	20" Stainless



VACUUMS & ACCESSORIES

J.E. ADAMS DECALS



BLUE



YELLOW



VIOLET

COLORED DECALS

J.E. ADAMS

- 6-piece vinyl decal set, sold as complete kit only
- Durable, UV protected, fade-resistant vinyl
- Covers maximum surface area for widest exposure

• **THESE DECALS WILL WORK FOR THE FOLLOWING VACUUMS:**

(Stainless Steel & Lighted Domes)
 VAA9200 Series, VAA9210 Series,
 VAA9213 Series, VAA9200-1 Series,
 VAA9200-3 Series, VAA9209 Series,
 VAA9209-6 Series

CALL	DEA920012	Blue
	DEA920011	Yellow
	DEA920013	Violet



4¾" H X 2½" W DECALS
 J.E. ADAMS VAC DECALS

- Power indicator and last coin alert

DEA8000-8



4¾" H X 2½" W DECALS
 J.E. ADAMS VAC DECALS

- Shock warning

DEA8183

BRIGHTEN UP YOUR VACUUMS WITH A NEW SET OF DECALS!
 THESE BOLD, BRIGHT DECALS FROM J.E. ADAMS COME IN A WIDE RANGE OF COLORS AND STYLES FOR TANKS, DOMES AND COIN BOXES.



16½" H X 6½" W DECALS
 J.E. ADAMS VAC DECALS

- Blue Faceplate Decal for Super Vac with Bill Validator & Digital Display
- Used on the following J.E. Adams models: 9200-1, 9200-1LD, 9200-3, 9200-3LD

CALL	DEA92001D112	Blue	CALL	DEA92001D113	Purple
	DEA92001D111	Yellow		DEA92001D110	Black

VACUUMS & ACCESSORIES



J.E. ADAMS AIR/WATER/VAC MACHINES



RETRACTABLE HOSE REEL BASE

AIR/WATER/VAC COMBO

J.E. ADAMS

STANDARD FEATURES:

- (2) 2 110 volt non-accumulating timers, vacuum and air or water can be used simultaneously
- 2 side-mounted retractable hose reels for both air & water
- 1 coin box w/ 2 mechanical coin acceptors takes quarters
- 2 service doors
 - Single pin lock coin box
 - 2 - 1.6 HP, 120 volt motors
- 4 quick change filter bags
- Toggle switch for air & water
- Optional security for service doors (8104), coin box security cover (8202W), lock bar (8206), Abus lock (6024), clean out bag (8599), 9427 dual service door security cover
- Hose color options: Red, blue, yellow, or green (black is standard)

CALL VEA8648GH



AIR/WATER/VAC COMBO

J.E. ADAMS

STANDARD FEATURES:

- (2) 2 110 volt non-accumulating timers, vacuum and air or water can be used simultaneously
- 1 coin box with 2 mechanical coin acceptors takes quarters
- 2 service doors
 - Single pin lock coin box
 - (2) 1.6 HP, 120 volt motors
- 4 quick change filter bags
- 25' wire mesh braided hose for air & water
- Toggle switch for air & water
- Optional security for service doors (8104), coin box security cover (8202W), lock bar (8206), Abus lock (6024), clean out bag (8599), 9427 dual service door security cover
- Hose color options: Red, blue, yellow, or green (black is standard)

CALL VEA8648G



WALL OR PEDESTAL MOUNTED!

AIR MACHINE

J.E. ADAMS AIR

STANDARD FEATURES:

- Mechanical coin acceptor takes quarters
- 110 volt non-accumulating timer
- High-security locking bar system with Medeco cam lock
- Gast 3/4 HP air compressor
- 25' wire mesh braided air hose with 90 PSI air gauge
- Mounts on VEA8819 pedestal sold separately

CALL VEA8670-2GA

FREE AIR MACHINE

J.E. ADAMS

- Gast 3/4 HP air compressor

CALL	VEA8670-2FGA	Push Button
	VEA8670-DIGPF	Digital

AIR MACHINE PEDESTAL

J.E. ADAMS

- Painted Steel

CALL VEA8819



Vacuums & air machines are a great way to increase revenue! Easy to install and maintain, while giving your customers the opportunity to clean their cars and check their tires - all in one convenient place!

GET THE EQUIPMENT AND ACCESSORIES YOU CAN RELY ON RIGHT HERE!

VACUUMS & ACCESSORIES

J.E. ADAMS AIR MACHINES



WALL OR PEDESTAL MOUNTED!



WALL OR PEDESTAL MOUNTED!

DIGITAL AIR MACHINE

J.E. ADAMS

- With the digital air machine, proper tire inflation is no longer a hassle. Automatic high-precision calibration is now quick and consistent. The unit automatically inflates a tire to within 0.5 PSI of the desired pressure. All the operator needs to do is set the target PSI. No need to shut off the unit as it reaches its goal. Ending over-inflation through advanced calibration. Introducing digital PSI calibration into the equation has made inexact, time-consuming manual inflation obsolete.
- Using the plus and minus buttons, set recommended tire pressure and connect the hose chuck to the tire valve stem. The unit will read the actual tire pressure, automatically inflate or deflate to the pre-set pressure. When complete, the gauge will automatically stop and beep, indicating that the operation is complete.

STANDARD FEATURES:

- Gast ¾ HP air compressor, oil-less, 18-month warranty
- Inflates to preset pressure
- Easy to read LCD backlit display
- Set desired tire pressure with (+) and (-) touch buttons
- Built in unit heater
- Temperature safe from -20° F to 158° F
- Automatic compressor shut off
- Electronic pressure relief valve
- High Security lock bar system
- Imonex mechanical coin acceptor takes quarters
- Flat tire button determines back pressure and fills accordingly
- Pressure range 4-70 PSI (accuracy +/- .5 PSI)
- Wall or pedestal mounted **PEDESTAL SOLD SEPARATELY**

CALL	VEA8670-DIGP	Air Machine
	VEA8670-DIGPW	Air & Water
	VEA8819	Pedestal

ECONOMY AIR MACHINE

J.E. ADAMS

STANDARD FEATURES:

- Requires 10 AMP service
- Dimensions: 11.06" H x 12.5" D x 17" W
- Gast ¾ HP air compressor, oil-less, 18-month warranty
- J.E. Adams Master Count 110 volt non-accumulating timer standard
- Cut-resistant 25' x 1/4" with wire braid service station quality air hose with 90 PSI inline air gauge
- Secured with (2) Medeco screw locks
- Imonex mechanical coin acceptor takes quarters
- Includes coin box cover, lock bar & abus lock
- Optional: "Free Service" wireless push-button remote control allows customers to receive free use of either service for the normal cycle time. The optional "Free Service" can be activated by the attendant or the cashier with the push of a button for customer convenience.
- Wall or pedestal mounted **PEDESTAL SOLD SEPARATELY**

CALL	VEA8685-2G	Air Machine
	VEA8819-50	Pedestal



MASTER COUNT TIMER VACUUM PARTS

- Master Count standard in 8685 series

\$155.41 VAA8712-JEA

VACUUMS & ACCESSORIES



J.E. ADAMS AIR MACHINES



WALL OR
PEDESTAL
MOUNTED!

AIR/WATER MACHINE

J.E. ADAMS

STANDARD FEATURES:

- Mechanical coin acceptor takes quarters
- 110 volt non-accumulating timer
- High security locking bar system with Medeco lock
- 25' wire mesh braided hose with 90 PSI air gauge
- 25' wire mesh braided water hose with lever activated water spout
- Gast 3/4 HP air compressor
- Mounts on VEA8819 pedestal sold separately
- Air/Water Machine includes push-button on/off

CALL	VEA8670-2WGA	Air Machine
	VEA8670-2WFGA	Free Air/Water Machine
	VEA8819	Pedestal



RETRACTABLE
HOSE REEL
BASE!

AIR MACHINE ON RETRACTABLE HOSE BASE

J.E. ADAMS

STANDARD FEATURES:

- Mechanical coin acceptor takes quarters
- 110 volt non-accumulating timer
- High security locking base system with Medeco cam lock
- Gast 3/4 HP air compressor
- Mounts on VEA6026 retractable air hose reel base sold separately

FREE AIR MACHINE:

- Gast 3/4HP air compressor
- Includes push-button on/off

RETRACTABLE HOSE REEL BASE:

- 25' wire mesh braided hose with 90 PSI air gauge

CALL	VEA8670-2BGA	Air Machine
	VEA8670-2FBGA	Free Air Machine
	VEA6026	Retractable Hose Base



RETRACTABLE
HOSE REEL
BASE!

AIR/WATER MACHINE ON RETRACTABLE HOSE BASE

J.E. ADAMS

STANDARD FEATURES:

- Mechanical coin acceptor takes quarters
- 110 volt non-accumulating timer
- Air and water can be used simultaneously
- Gast 3/4 HP air compressor
- Mounts on VEA6025 retractable air and water hose reel base sold separately

FREE AIR & WATER MACHINE:

- Gast 3/4 HP air compressor
- Includes push-button on/off

RETRACTABLE HOSE REEL BASE:

- 25' wire mesh braided hose with 90 PSI air gauge
- 25' wire mesh braided water hose with lever activated water spout

CALL	VEA8670-2WBGA	Air Machine
	VEA8670-2WFBGA	Free Air & Water Machine
	VEA6025	Retractable Hose Base



- Bases/Pedestals are sold separately
- A great add-on at any location
- Keeping a spare air hose and air chuck on hand is an excellent idea!

120 VOLT NON-ACCUMULATING VACUUM TIMER VACUUM PARTS

\$54.75 **VEA871214-120**



VACUUMS & ACCESSORIES

AIR MACHINE PARTS & DECALS



WATER SPOUT FOR AIR/WATER MACHINE
AIR MACHINE REPLACEMENT PARTS

\$31.78 VEA8647



GAST COMPRESSOR
AIR MACHINE REPLACEMENT PARTS

\$660.72 VEA9862

KIT COMPRESSOR & BRACKET
AIR MACHINE REPLACEMENT PARTS

\$656.69 VEA9862-1A



TIRE INFLATOR W/ GAUGE
AIR MACHINE REPLACEMENT PARTS

\$39.62 VAA8533



AIR HOSE ASSEMBLY
AIR MACHINE REPLACEMENT PARTS

\$54.48 VAA8532



WHIP ASSEMBLY
AIR MACHINE REPLACEMENT PARTS

\$10.00 VAA853311



.75¢ AIR DECAL
AIR MACHINE DECALS

\$2.76 DEA85671



AIR DECAL KIT
AIR MACHINE DECALS

\$47.65 VAA84301AKIT Decal Kit
\$8.31 DEA84302 Side Decal Only

ACME TIRE INFLATORS



INFLATOR WITH GAUGE DUAL END
ACME TIRE INFLATORS

\$24.44 AC0505



INFLATOR WITH GAUGE STRAIGHT
ACME TIRE INFLATORS

\$22.36 AC0500



REPLACEMENT HOSE & NOZZLE
ACME TIRE INFLATORS

\$6.66 AC0510



REPLACEMENT CHUCKS
ACME TIRE INFLATORS

\$4.56 AC812 Replacement Chuck with Barb
\$4.75 AC0512 Replacement Chuck with 1/4" F

BLOW GUNS



TYPHOON ADJUSTABLE AIR COMPRESSOR BLOW GUN
COILHOOSE® PNEUMATICS

• Used for non-contact cleaning. Removes debris and dust using compressed air. Constructed with a non-marring high-performance polymer so tough it still operates after being driven over.

SPECIFICATIONS:

- Construction: High Performance Polymer
- Knob: Air Flow Adjustable Knob
- Color: Black and Red
- Inlet: 1/4" NPT
- OSHA Compliant: OSHA 1910.242B and OSHA 1910.95
- Weight: 0.40 lbs.

FEATURES:

- Durable Polymer Construction
- Maximum Power and Performance
- Flow Control Built-In
- Non-Marring Body and Tip
- OSHA Compliant

\$18.83 TYP-2505-DL

VACUUMS & ACCESSORIES



J.E. ADAMS DETAIL STATIONS



WALL OR PEDESTAL MOUNTED!

SHAMPOO/SPOT REMOVER

J.E. ADAMS

STANDARD FEATURES:

- Wall or pedestal mount
- Large digital display timer scrolls messages, counts down time, scrolls prices of services
- Imonex mechanical quarter coin acceptor comes standard, additional mechanical coin acceptors are available
- Pin lock style coin box
- Internal automatic heater
- Gast 1/12 HP oil-less compressor
- Medeco threaded door locks
- Rocker switch on brush handle to select between shampoo and spot remover
- 1 oz. of shampoo or spot remover makes 2½ gallons of foam
- **SHOWN WITH OPTIONAL DECAL. ALSO AVAILABLE IN YELLOW. STANDARD DECAL IS BLACK.**

SHAMPOO/SPOT REMOVER/ FRAGRANCE STATION

J.E. ADAMS

STANDARD FEATURES:

- Toggle between 3 fragrances, spot remover & shampoo
- Wall or optional pedestal mount
- Large digital display timer - scrolls messages, counts down time, scrolls price of services
- Imonex mechanical quarter coin acceptor comes standard, additional mechanical coin acceptors are available
- Pin lock style coin box
- Internal automatic heater
- Gast 1/12 HP oil-less compressor
- Medeco threaded door locks
- Rocker switch on brush handle to select between shampoo and spot remover
- 1 oz. of shampoo or spot remover makes 2½ gallons of foam
- Dispenses ¾ oz of fragrance in 30 seconds

FRAGRANCE STATION

J.E. ADAMS

STANDARD FEATURES:

- Requires 10 AMP service
- Dispenses your choice of 3 fragrances (Wild Cherry, New Car, French Vanilla)
- Fragrance dispenses .75 oz of fragrance formula per thirty seconds, which is equal to 1.5 oz of liquid formula per minute. 1 gallon of liquid formula = 128 oz and the dispensing rate is 1.5 oz per minute. One gallon of liquid formula yields 85 minutes of vend time or 170 thirty-second vend cycles.
- Average vend time \$1.00 for 1 minute.
- Wall or pedestal mounted (Item #8819)
- **PEDESTAL SOLD SEPARATELY**
- Louvered sides minimize heat build-up inside cabinet
- Imonex mechanical quarter coin acceptor comes standard
- Large Dixmor digital display timer – scroll messages, counts down time, scrolls price of services
- Digital display can be easily programmed with remote control which is available at a nominal charge
- Medeco threaded door locks (Replacement Item #8958-1)
- Pin lock style coin box (Replacement Item #8638)
- Internal automatic heater
- Indicator light shows when unit has power
- Optional last coin alert and additional mechanical coin acceptors are available

CALL	VAA11000	Machine
	VEA8819	Floor Pedestal

CALL	VAA12000	Machine
	VEA8819	Floor Pedestal

CALL	VAA13000	Fragrance Station
	VAA13000V	With Bill Acceptor
	VAA13000VR	Vault Ready

SHORT ON SPACE?

J.E. Adams detail stations are a profitable and unique way to draw attention to your site when space is at a premium. Units can be wall-mounted or placed on a pedestal.

VACUUMS & ACCESSORIES

IVS ARCH VACUUM SYSTEMS & AIR MACHINES



INDUSTRIAL VACUUM SYSTEMS

ARCH BAY VACUUM SYSTEM INDUSTRIAL VACUUM SYSTEMS

• Attract customers with this popular and custom look at your car wash. The swivel or fixed boom design keeps your hoses off the ground so they don't get dirty, and are easy for your customers to use. The system can be ordered in a single or dual-boom configuration. IVS engineered the ARCH BAY VACUUM SYSTEMS out of stainless steel for durability and a long service life. The boom arm can swivel 180° or it can be locked into a fixed position. Comes with LED lighting. Signage can be customized for your car wash's branding. Vacuum can be controlled by a free vac push-button or a coin box.

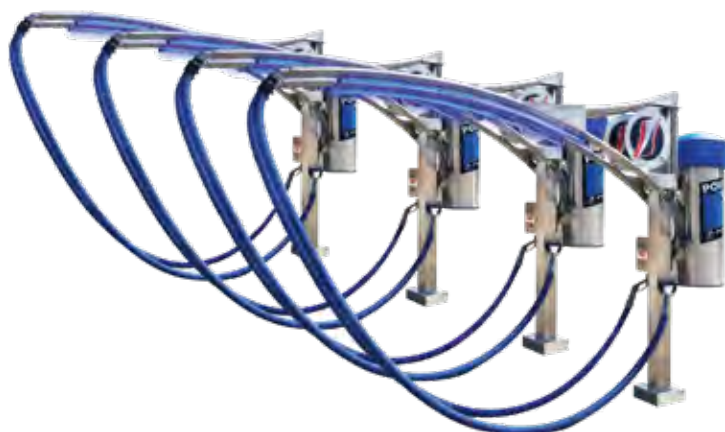

- Single or dual arm
- Flexibility - connects to any IVS vacuum or central vac system
- Stainless steel construction for long-lasting durability
- Adjustable boom(s) can swivel 180° or can be fixed stationary
- Customizable LED lighting, trash bins, racks, mounting options for pylon or islands, coin box or free vac timer options
- Branded signage on arch can be custom printed/branded

DIMENSIONS:

- **BOOM ARM:** 120" Long • **BASE POLE:** 99" Tall

POLE MOUNT 3 MOTOR ARCH VACUUM INDUSTRIAL VACUUM SYSTEMS

- Blue lighted dome
- Blue hose
- Dual intake snap seal filters
- (3) 120V Motors

CALL VAI100070

DOUBLE ARCH POLE PACKAGES INDUSTRIAL VACUUM SYSTEMS

CALL VAI100071

SINGLE ARCH POLE PACKAGES INDUSTRIAL VACUUM SYSTEMS

CALL VAI100072

AIR MACHINE

INDUSTRIAL VACUUM SYSTEMS

- IVS proprietary Air Compressor
- ¼" steel braided rubber 25' air hose assembly
- 14 gauge stainless steel construction
- Optional hose hanger mounting
- 110V accumulating timer assembly
- 1-85 PSI tire inflation
- Air inflation gauge
- Concealed pin lock locking mechanism
- Internal coin drawer with lock mounting

PRODUCT OPTIONS:

- Imonex mechanical coin acceptor (standard)
- Sensortron single coin electronic coin acceptor (optional)
- Multitron World Edition electronic coin acceptor (optional)
- IDX MA-850 coin acceptor (optional)
- Mars MEI \$1, \$5 bill acceptor assembly (optional)

POWER REQUIREMENTS:

- 120 vac single phase

CALL	VAI90001-I	Red W/ Imonex Coin Acceptor
	VAI90001-I-BL	Blue W/ Imonex Coin Acceptor
	VAI90001-I-Y	Yellow W/ Imonex Coin Acceptor
	VAI90001-I-G	Green W/ Imonex Coin Acceptor
	VAI90001-S	W/ Sensortron Coin Acceptor
	VAI90001-F	Free W/ Push Button
	VAI90001P	Pedestal

MINI POWER VAC

INDUSTRIAL VACUUM SYSTEMS

- Featuring the power you expect from IVS in a compact profile that's light enough to ship non-freight! Multiple mounting options are available for maximum flexibility

STANDARD FEATURES:

- Airflow - 94 CFM, 84", suction lift (water)
- Motor - 900 Watt electric; by-pass, two stage, 7 amp
- Electronic timer - Direct, switch-type, high capacity output, accumulates 1 to 15 coins, controls cycle time from 2 seconds to 8.5 minutes per coin or on/off toggle switch.
- Hose - 1½" x 15' long, high flex crushable plastic, includes cuff and polyethylene hand tool plus crevice tool
- Tank - 18 gauge powder coated steel
- Wall or post mount
- 50 lbs.
- **ALSO AVAILABLE WITHOUT COIN ACCEPTOR**

CALL	MPV1000	W/ Sensortron Coin Acceptor
	MPV2000	W/ ON/OFF switch



WALL OR
PEDESTAL
MOUNTED!

VAI90001-I



VAI90001-I-Y



VAI90001-I-G



VAI90001-I-BL



PLEASE SPECIFY COLOR WHEN ORDERING.
AVAILABLE IN BLUE, RED, GREEN AND BLACK!

VACUUMS & ACCESSORIES



IVS POWER VACS

POWER VAC - COMMERCIAL

INDUSTRIAL VACUUM SYSTEMS

STANDARD FEATURES:

- Floor mount
- Two heavy-duty motors deliver maximum cleaning power and reliable performance
- High-capacity filter system - Reduces maintenance intervals, saves you money
- Perform routine filter changes and maintenance quickly reduces operating costs and labor
- Large-bore hose with anti-clog inlet design keeps your vacuums running profitably
- Stainless steel construction stands up to the toughest environments

CALL	VAI100002	Commercial Vac - 2 Motors
	VAI100002-3	Commercial Vac - 3 Motors, Stainless Steel Dome, On/Off Toggle
	VAI100005	Pole Or Wall Mounting, 2 Motors, On/Off Toggle
	VAI100005PB	Vacuum, Pole/Wall Mount, 2 Motors, Push Button
	VAI100006-2	Commercial Vac - 3 Motors, Stainless Steel Dome, Dual Hose, Push Button



VAI100002



VAI100005

POWER VAC

INDUSTRIAL VACUUM SYSTEMS

STANDARD FEATURES:

- Large bore hose (2") with anti-clog inlet design
- Mechanical coin mechanism
- 4-bag filter system
- Integral coin vault with pin lock
- 2 heavy-duty motors
- Eye-catching graphics

OPTIONS AVAILABLE:

- Single or multi coin acceptor
- Meter panel security bar
- Mirror finish
- Third motor
- Lighted dome, choose from 5 colors (white, red, blue, yellow, green)
- Locking clean out door shroud
- Coin vault security bar
- Set up for in-ground safe
- Quiet kit (factory installed)
- Bill acceptor

CALL	VAI140000	2 Motors, SS Dome, Imonex
	VAI140000-2LD	2 Motors, Lighted Dome, Imonex
	VAI140000-3	3 Motors, SS Dome, Imonex
	VAI140000-3LD	3 Motors, Lighted Dome, Imonex
	VAI140000-3LDM	3 Motors, Digital Display, Lighted Dome, Mars \$1-5
	VAI140001	For In-Ground Safe



VAI140000



VAI140001



VAD1030



VAI106204



TIGS403



POWER VAC - AIR / VAC

INDUSTRIAL VACUUM SYSTEMS

STANDARD FEATURES:

- Large bore hose (2") with anti-clog inlet design
- Integral coin vault with pin lock
- 4-bag filter system
- High-flow air compressor
- Eye-catching graphics
- Mechanical coin mechanism
- 2 heavy-duty motors

OPTIONS AVAILABLE:

- Bill acceptor
- Quiet kit (factory installed)
- Lighted dome, choose from 5 colors (white, red, blue, yellow, green)
- Coin vault security bar, meter panel security bar
- Locking clean-out door shroud

CALL	VAI240000	GinSan Compressor - Imonex
	VAI240000G	Gast Compressor - Imonex
	VAI240001	For In-Ground safe



VAI104583*

POWER VAC SERIES REPLACEMENT PARTS

INDUSTRIAL VACUUM SYSTEMS

* DECAL KITS INCLUDE:
TANK DECAL, DOME DECAL, \$.75 - \$1.25 BLACK/SILVER DECALS, BLACK/SILVER COIN BOX DECAL

\$301.34	VAI102500	Stainless Steel Dome
\$143.75	VAI102502	Red Dome
\$143.75	VAI102503	Yellow Dome
\$143.75	VAI102504	White Dome
\$143.75	VAI102505	Green Dome
\$143.75	VAI102507	Blue Dome
\$132.12	TIGS403	Ginsan GS403

\$26.35	VAI107803	110V/24V Transformer
\$60.06	VAI106204	Relay & Socket
\$154.29	CB0201	Ginsan Sensortron
\$318.75	VAI104529	Lock Shroud
\$8.79	DKPV100	Decal Kit - Warning Labels (3)
\$1.17	VAI102309	\$.125 Black/Silver Decal
\$1.17	VAI102308	\$1.00 Black/Silver Decal

\$1.78	VAI106800	Motor Screen
\$30.17	VAD1030	Clean Out Bag (Vinyl)
\$60.06	VAI105802	Electric Channel
\$15.00	VAD1000	Filter Bags
\$68.84	VAI1045940	Air/Vac Decal Kit
\$22.36	AC0500	Tire Inflator with Gauge
\$96.44	VAI1040020	Air/Vac Hose - 25'

VACUUMS & ACCESSORIES

IVS POWER VAC COMBO UNITS



POWER VAC SHAMPOO COMBO UNIT

INDUSTRIAL VACUUM SYSTEMS



STANDARD FEATURES:

- Utilizes the Dixmor LED6 Sooper display as timer and control, all in one
- 2 extended brush life motors
- Lockable cash box keeps profits secure and out of sight
- Heavy 12-gauge steel doors and control box with high security plug style locks
- VAI5500 & VAI5510: No jugs or tanks to refill
- Bottom of the unit offers ample space for your own gallon jugs
- Industrial, heavy-duty relays and contactors
- Compact profile uses standard vacuum mounting pattern for easy upgrading from your existing vacuums
- Lock shroud option to provide limited access to filters and debris collector

SPECIFICATIONS:

- VAI5500 & VAI5510 Motors: 2 Motor Combo 120V Extended Brush Life
- VAI5520 Motors: 3 Motor Combo 120V Extended Brush Life
- Dome Color: Specify (Blue, Yellow, Red, Green, White)
- Dome Light Kit: 120V
- Hose Tool: Duckfoot 2" with Straight Cuff
- Hose: 2"x15' ; Black (other colors available)
- Coin Acceptor: Sensortron 2

CALL	VAI5500	No Bill Acceptor
	VAI5500-BA	W/ Bill Acceptor, CPI Talos \$1 & \$5 Bill Acceptor
	VAI5510	No Bill Acceptor
	VAI5510-BA	W/ Bill Acceptor, CPI Talos \$1 & \$5 Bill Acceptor
	VAI5520	No Bill Acceptor
	VAI5520-BA	W/ Bill Acceptor, CPI Talos \$1 & \$5 Bill Acceptor



VAI102329



DEA8173



VAI102349



VAI102310R

IVS DECALS

DECALS

PRICE	PART #	DESCRIPTION
\$70.27	VAI104585*	Power Vac Blue Tank Decal & Blue Dome Instructional Decal
\$1.17	VAI102308	\$1.00 Silver/Black
\$68.84	VAI104583	Power Vac Red Tank Decal & Red Dome Instructional Decal VAI102310R
\$30.76	DKAV100	Air/Vac Decal Kit
\$30.76	VAI102329	Power Vac Yellow
\$19.03	VAI102335	Dome Instruction Yellow
\$17.57	VAI102339	Dome Instruction Teal/Black
\$52.73	VAI102349	2 piece Power Vac, red, white & blue
\$2.24	VAI102386	.75¢ Black/Silver

* DECAL KITS INCLUDE: TANK DECAL, DOME DECAL, \$.75 - \$1.25 BLACK/SILVER DECALS, BLACK/SILVER COIN BOX DECAL



RED, GREEN, BLUE TECH

RED, BLUE GRID

USA



RED, WHITE & BLUE DECALS 4" x 2½"

DECALS

\$1.15	VA30077	50¢
\$1.15	VA30216	75¢
\$1.15	VA30301	\$1.00

DELUXE VAC TANK DECALS

VACUUM ACCESSORIES

- Peel & Stick
- 31" x 10"

\$19.99	VA50025R	Red Tech
	VA50025G	Green Tech
	VA50025BL	Blue Tech
	VA50065R	Red Grid
	VA50065BL	Blue Grid
	VA50050	USA

KLEEN-RITE TANK DECALS

DECALS

- Peel & Stick
- 31" x 10"

\$8.99	VA40026R	Red
	VA40026Y	Yellow
	VA40026BK	Black
	VA40026BL	Blue
	VA40026G	Green

4" W x 3" H RED & WHITE

DECALS

\$0.78	CB0373
--------	--------



PLEASE DO NOT VACUUM WATER

DECALS & SIGNS

\$6.99	SI0136	12" x 12" Sign
\$0.92	DE040	3" x 3" Decal
\$0.92	DE040S	3" x 3" Decal - Spanish



VACUUMS & ACCESSORIES



J.E. ADAMS ULTRA SERIES VAC ISLAND CANOPIES & BASES



8' VAC ISLAND & CANOPY

J.E. ADAMS

- Ultra Single 8' Vacuum Island Base (32008) and Canopy (32008CAN)
- All models include two poles



12' VAC ISLAND & CANOPY

J.E. ADAMS

- Ultra 12' Vacuum Island Base (32012) and Canopy (32012CAN) with Ultra Turbo-Nator and Ultra 6-in-1 Combination Vacuums

CANOPIES

J.E. ADAMS

- Available in red, blue, yellow & green
- Unique two-piece modular canopy design is more cost effective to ship
- Aluminum frame, poles and vinyl cover make the canopy lightweight, durable, and weather resistant – logo can be customized for an additional fee
- Easily assembles in about one hour
- Canopies come with fluorescent light fixtures with easy access to bulbs for replacement
- One section could be replaced if damaged at your location – unlike one-piece construction

FOR USE WITH BASE

J.E. ADAMS

32008CAN	8' Single Vacuum Island Canopy
32010CAN	10' Vacuum Island Canopy
32012CAN	12' Vacuum Island Canopy

FOR USE WITHOUT BASE

J.E. ADAMS

32008CAN-NB	8' Single Vacuum Island Canopy
32010CAN-NB	10' Vacuum Island Canopy
32012CAN-NB	12' Vacuum Island Canopy



BASES

J.E. ADAMS

- Black bumper guards
- Total stainless steel construction including interior frame and vacuum platforms provide years of use while still looking like new
- Unique modular construction consists of three separate pieces (double vacuum island bases) and two separate pieces (single vacuum island base)
- Modular construction results in reduced freight costs; easily assembles without a forklift in about two hours
- Tepee mat holder with (4) mat clamps are permanently attached to the center module which cuts down on potential replacement parts
- Modular design allows for replacement of any section or part if damaged at your location (unlike one-piece designed islands requiring total replacement)
- Trash service door is secured with (2) Medeco cam locks and trash can be deposited from four directions into container
- Slide-out trash removal is readily accessible by door

FOR USE WITH CANOPY

J.E. ADAMS

32008	8' Single Vacuum Island Base
32010	10' Vacuum Island Base
32012	12' Vacuum Island Base

FOR USE WITHOUT CANOPY

J.E. ADAMS

32008-1	8' Single Vacuum Island Base
32010-1	10' Vacuum Island Base
32012-1	12' Vacuum Island Base

VAULT READY

J.E. ADAMS

32008VR	8' Single Vacuum Island Base - Vault Ready
32010VR	10' Vacuum Island Base - Vault Ready
32012VR	12' Vacuum Island Base - Vault Ready

EXPRESS VACUUMING REPAIR & REPLACEMENT PARTS





When your vacuums begin to lose suction, you begin to lose money. Many customers place equal importance on interior and exterior cleaning, and aren't interested in a weak vacuum that barely works. Without effective suction, customers may start to feel your car wash doesn't deliver the cleanliness they seek!

That's why Kleen-Rite sells express vacuuming repair and replacement parts for your car wash vac systems. These top selling items are inexpensive yet essential - perfect for replacing worn vacuum parts! As with any piece of equipment at your car wash, the right parts are necessary to keep your vacuum in good shape.



KLEEN-RITE VAC HOSE



-  Kleen-Rite offers many affordable vacuum hose options.
-  Plus, these flexible hoses are all made in America!
-  **COLOR OPTIONS:** Include red, blue, black, gray, and yellow
-  **HOSE LENGTHS:** Include 15' and 50'
-  **DIAMETERS:** 2" and 1½"

VACUUM NOZZLES



During vacuum upkeep, remember that suction loss could be the result of a cracked or broken nozzle!

A vacuum crevice tool slim nozzle makes it possible to reach tight, hard-to-access areas in vehicles. A claw nozzle has a wide design for cleaning interior surfaces.

SWIVEL CUFFS



Another handy item that can reduce damage to your vac hose is a swivel cuff. The cuff allows the hose to swivel around and move easily during use, to avoid twisting and kinking. Not only does it help reduce hose damage, but it also improves maneuverability for customers.

INLET VALVES & HOSE ADAPTERS

Inlet valves provide a quick connection of a male hose coupling to the vac system. Hose adapters connect another piece of hose or an attachment to your existing hose.

Kleen-Rite sells two popular items compatible with 1½" hose. These aluminum parts offer a durable alternative to plastic models.

INLET VALVE



KR# VCV500

HOSE ADAPTER



KR# VCHA150

FEATURED PRODUCT

EXPRESS VACUUM SYSTEM PARTS



VAC NOZZLE HANGERS

EXPRESS VACUUM SYSTEMS

• Nozzle hangers fit 1 3/4" to 2 1/2" O.D. Pole

\$45.09	VCHH15	Fits 1 1/2" Nozzle ONLY	\$42.35	VCHH30	Fits 1 1/2"-2" Claw Crevice Tools
\$6.65	VCHHRPB	Replacement Pad for VCHH15	\$5.42	VCHHRPC	Replacement Pad for VCHH30

NOZZLES

EXPRESS VACUUM SYSTEMS

1 1/2" PLASTIC NOZZLES		2" PLASTIC NOZZLES	
PRICE	PART #	PRICE	PART #
\$2.15	VAB-15	\$2.15	VAB-20

AVAILABLE IN MANY COLORS - BULK PURCHASING AVAILABLE

SWIVEL CUFFS

EXPRESS VACUUM SYSTEMS

PRICE	PART #	DESCRIPTION/SIZE	COLOR
\$1.85	VAA-10S	1 1/2" Hose / 1 1/2" Nozzle	Gray

AVAILABLE IN GRAY AND BLACK + MANY SIZE CONFIGURATIONS - SEE BELOW FOR FULL LISTING

KLEEN-RITE VACUUM HOSES

EXPRESS VACUUM SYSTEMS

1 1/2" x 15' HOSE		2" x 15' HOSE		1 1/2" x 50' HOSE		2" x 25' HOSE		2" x 50' HOSE	
PRICE	PART #	PRICE	PART #	PRICE	PART #	PRICE	PART #	PRICE	PART #
\$19.40	KRVH41	\$23.35	KRVH45	\$59.62	KRVH43	\$37.78	KRVH46	\$77.56	KRVH47

AVAILABLE IN MANY COLORS - SEE THE KLEEN-RITE VACUUM HOSES PAGE IN THE SECTION FOR FULL LISTING!

REPAIR CUFF

EXPRESS VACUUM SYSTEMS

PRICE	PART #	SIZE	COLOR
\$2.23	VAA-4	1 1/2"	Gray

HOSE ADAPTER

EXPRESS VACUUM SYSTEMS

PRICE	PART #	SIZE
\$13.45	VCHA150	1 1/2"

INLET VALVE

EXPRESS VACUUM SYSTEMS

PRICE	PART #	SIZE
\$25.67	VCV500	2" MPT x 1.5" HOSE

SWIVEL CUFFS

EXPRESS VACUUM SYSTEMS

PRICE	PART #	DESCRIPTION/SIZE	COLOR
\$1.85	VAA-10S	1 1/2" Hose / 1 1/2" Nozzle	Gray
\$1.85	VAA-10SBK	1 1/2" Hose / 1 1/2" Nozzle	Black
\$3.69	VAA-5S	2" Hose / 2" Nozzle	Gray
\$3.69	VAA-5SBK	2" Hose / 2" Nozzle	Black
\$2.89	VAA-19S	2" Hose / 1 1/2" Nozzle	Gray
\$4.80	VAA200-200	2" Hose / 2" Hose • Double Threaded	Gray
\$3.09	VAS22P	2" Hose / 2" Nozzle • With Swivel Nut	Gray
\$4.38	VAA125-125	1 1/4" Hose / 1 1/4" Hose • Double Threaded	Gray
\$4.45	VAA150-150	1 1/2" Hose / 1 1/2" Hose • Double Threaded	Gray
\$4.73	VAA150-200	1 1/2" Hose / 2" Hose • Double Threaded	Gray
\$3.67	VAAC-5	2" Repair Cuff	Gray
\$2.29	VAAC-4	1 1/2" Repair Cuff	Gray
\$1.39	VASN2	2" Swivel Nut	-

FLASH CUFFS

EXPRESS VACUUM SYSTEMS

PRICE	PART #	DESCRIPTION/SIZE
\$15.82	AH201	Reducer • 2" cuff to 1 1/2" hose
\$12.65	AH204	Female Cuff • 2"
\$10.21	AH206	Male Cuff • 2"

NOZZLE ADAPTERS

EXPRESS VACUUM SYSTEMS

PRICE	PART #	DESCRIPTION/SIZE	COLOR
\$2.23	VAA-4	1 1/2" Hose / 1 1/2" Nozzle	Gray
\$2.23	VAA-4BK	1 1/2" Hose / 1 1/2" Nozzle	Black
\$2.29	VAA-5	2" Hose / 2" Nozzle	Gray
\$2.71	VAA-19	2" Hose / 1.5" Nozzle	Gray
\$3.89	VAA-5BK	2" Hose / 2" Hose	Black
\$2.53	VAA-15	1 1/2" Hose / 2" Tank	Gray
\$2.53	VAA-15BK	1 1/2" Hose / 2" Tank	Black

HOSE ADAPTERS & INLET VALVES

EXPRESS VACUUM SYSTEMS

PRICE	PART #	DESCRIPTION/SIZE
\$13.45	VCHA150	1 1/2" hose adapter
\$17.95	VCHA200	2" x 6" hose adapter
\$51.02	VCV520	2" inlet fits 2" pipe thread
\$48.97	VCV520-C	2" inlet with clasp fits 2" pipe thread
\$25.67	VCV500	1 1/2" Inlet with clasp fits 2" pipe thread

FEATURED PRODUCT

SWIVEL CUFFS & NOZZLE ADAPTERS



VAA-10S
SWIVEL CUFFS

- 1½" Hose • 1½" Nozzle

\$1.85 VAA-10S



VAA-10SBK
SWIVEL CUFFS

- 1½" Hose • 1½" Nozzle

\$1.85 VAA-10SBK



VAA200-200
SWIVEL CUFFS

- 2" Hose

\$4.80 VAA200-200



VAA125-125
SWIVEL CUFFS

- 1¼" Hose

\$4.38 VAA125-125

FOR SHOP VACS



VAA-5S
SWIVEL CUFFS

- 2" Hose • 2" Nozzle

\$3.69 VAA-5S



VAA-5SBK
SWIVEL CUFFS

- 2" Hose • 2" Nozzle

\$3.69 VAA-5SBK



VAS22P
SWIVEL CUFFS

- 2" Hose • 2" Nozzle

\$3.09 VAS22P

COMES WITH SWIVEL NUT



VAA-19S
SWIVEL CUFFS

- 2" Hose • 1½" Nozzle

\$2.89 VAA-19S



VAA-5BK ADAPTER
NOZZLE ADAPTER

- 2" Nozzle

\$3.89 VAA-5BK



2" SWIVEL NUT
SWIVEL CUFFS

\$1.39 VASN2



VAA150-200
SWIVEL CUFFS

- 1½" Hose • 2" Hose

\$4.73 VAA150-200



VAA-4
NOZZLE ADAPTERS

- 1½" Hose • 1½" Nozzle

\$2.23 VAA-4 Gray
\$2.23 VAA-4BK Black



VAA-5
NOZZLE ADAPTERS

- 2" Hose • 2" Nozzle

\$2.29 VAA-5



VAA-19
NOZZLE ADAPTERS

- 2" Hose • 1½" Nozzle

\$2.71 VAA-19



VAAC-5
REPAIR CUFFS

- 2"

\$3.67 VAAC-5



VAAC-4
REPAIR CUFFS

- 1½"

\$2.29 VAAC-4



VAA-15
NOZZLE ADAPTERS

- 1½" Hose • 2" Tank

\$2.53 VAA-15 Gray
\$2.53 VAA-15BK Black

UPHOLSTERY CUFFS



VAA UPHOLSTERY CUFFS
UPHOLSTERY CUFFS

\$3.95 VAA-20 2" Hose • 1½" Nozzle
\$3.10 VAA-20A 2" Cuff
\$2.09 VAA-1 1½" Cuff



VAN-115
UPHOLSTERY CUFFS

- 2" Hose • 1½" Cuff

\$3.41 VAN-115



VANS-115
UPHOLSTERY CUFFS

- 2" Hose • 1½" Swivel

\$4.62 VANS-115

COMES WITH SWIVEL NUT

HOSE ADAPTERS & INLET VALVES

TOP SELLER!



HOSE ADAPTER
ADAPTERS & VALVES

- 1½" For Hose & Central Vacuums

\$13.45 VCHA150

TOP SELLER!



INLET VALVE
ADAPTERS & VALVES

- 2" MPT x 1½" For Hose & Central Vacs

\$25.67 VCV500

DON'T SEE EXACTLY WHAT YOU'RE LOOKING FOR?

Visit our website for our full selection of vacuum accessories!

VACUUMS & ACCESSORIES

VACUUM NOZZLES, TOOLS & ACCESSORIES



BUY A CASE OF 50 VAC NOZZLES FOR THE COST OF \$1.25 A PIECE!

2" PLASTIC NOZZLE

MR. NOZZLE VACUUM SUPPLIES

\$2.15	VAB-20B	Black	●
\$2.15	VAB-20BL	Blue	●
\$2.15	VAB-20G	Gray	●
\$2.15	VAB-20O	Orange	●
\$2.15	VAB-20R	Red	●
\$2.15	VAB-20Y	Yellow	●



1½" PLASTIC NOZZLE

MR. NOZZLE VACUUM SUPPLIES

\$2.15	VAB-15B	Black	●
\$2.15	VAB-15BL	Blue	●
\$2.15	VAB-15G	Gray	●
\$2.15	VAB-15O	Orange	●
\$2.15	VAB-15R	Red	●
\$2.15	VAB-15Y	Yellow	●



1½" CREVICE TOOL (16" LONG)

MR. NOZZLE VACUUM SUPPLIES

\$3.30	VACT15	Orange	●
\$3.30	VACT20	Black	●
\$3.30	VACT25	Gray	●



2" CREVICE TOOL (15.5" LONG)

MR. NOZZLE VACUUM SUPPLIES

\$3.30	VACT50	Orange	●
\$3.30	VACT55	Black	●
\$2.63	VACT5	Gray	●



CREVICE CLAWS

MR. NOZZLE VACUUM SUPPLIES

- Allows customers to clean their car thoroughly by combining the claw nozzle and the crevice tool!

\$4.32	VACT150	1½"
\$4.32	VACT200	2"



1½" x 24" LONG VAC NOZZLE

MR. NOZZLE VACUUM SUPPLIES

\$4.74	VAB-15LBL
--------	-----------



VAC NOZZLE HANGERS

MR. NOZZLE VACUUM SUPPLIES

- Both fit 1¾" to 2½" O.D. Pole

\$45.09	VCHH15	Fits 1½" Nozzle ONLY
\$6.65	VCHHRPB	Replacement Pad for VCHH15
\$42.35	VCHH30	Fits 1½"-2" Claw Crevice Tools
\$5.42	VCHHRPC	Replacement Pad for VCHH30

VCHH30



VAC TOOL KIT

MR. NOZZLE VACUUM SUPPLIES

KIT INCLUDES:

- 12' hose
- 1½" nozzle w/black cuff
- 1½" swivel cuff
- For use with wet/dry vacs
- Claw & crevice tool

\$30.64	VACTK
---------	-------



15" L x 1½" METAL CREVICE TOOL

VACUUM SUPPLIES

\$8.42	VACTM15
--------	---------



ALUMINUM CLAW WITH SWIVEL CUFF

VACUUM SUPPLIES

\$27.35	GS20237	2" Aluminum Claw
\$32.94	GS20256	1½" Aluminum Claw



ERIE VAC NOZZLES

ERIE BRUSH VACUUM SUPPLIES



PRICE	PART #	DESCRIPTION
\$3.50	EB811500	1½" Hose Black Plastic Vac Nozzle 13" Long
\$4.40	EB811700	1.5" Hose Black Plastic Vac Nozzle 24" Long
\$3.28	EB812500	2" Hose Black Plastic Vac Nozzle 9" Long
\$3.28	EB812700	2" Hose Black Plastic Vac Nozzle 14"
\$4.54	EB811502	1½" Hose Yellow SUPER Plastic Vac Nozzle 13" Long
\$4.54	EB811502	1½" Hose Yellow SUPER Plastic Vac Nozzle 24" Long
\$4.54	EB812502	2" Hose Yellow SUPER Plastic Vac Nozzle 9" Long
\$4.54	EB812702	2" Hose Yellow SUPER Plastic Vac Nozzle 14" Long

VACUUMS & ACCESSORIES

VACUUM HOSES AND PARTS



50' x 2" VAC HOSE

VACPRO VACUUM HOSES

PLASTIFLEX

- Flexible & light weight!

VAK47G	Gray
VAK47R	Red
VAK47BY	Yellow
QTY. OF ONE & UP \$91.00	



RED, WHITE & BLUE VAC HOSE

VACPRO VACUUM HOSES

PLASTIFLEX



RAINBOW VAC HOSE

VACPRO VACUUM HOSES

PLASTIFLEX

\$28.53 VAK45RWB 2" x 15'

\$41.54 VAK45RB 2" x 16'



15' x 2" VAC HOSE

VACPRO VACUUM HOSES

PLASTIFLEX

- Flexible & light weight!

VAK45BE/BK	Beige/Black
VAK45BK	Black
VAK45BL	Blue
VAK45G	Gray
VAK45R	Red
VAK45BY	Yellow
VAK45BK/BL	Black/Blue
VAK45BL/BK	Blue/Black
VAK45BL/R	Blue/Red
VAK45BY/R	Yellow/Black
VAK45BY/R	Yellow/Red
VAK45G/BK	Gray/Black
VAK45GG	Green
VAK45GG/BK	Green/Black
QTY OF 1-6 \$28.57	
BOX OF 7 27.03	

VAK45OR	Orange
VAK45OR/BK	Orange/Black
VAK45P/BY	Purple/Yellow
VAK45R/BK	Red/Black
VAK45R/BL	Red/Blue
VAK45T	Teal
VAK45T/BK	Teal/Black
VAK45TQ/BK	Turquoise/Black
QTY OF 1-6 \$28.53	
BOX OF 7 26.74	



JIM COLEMAN® PUSH BUTTON FOR COMBO VACUUMS

VACUUM ACCESSORIES

\$12.63 VAC225



DILLING & HARRIS PUSH BUTTON SWITCH FOR COMBO VACS

VACUUM ACCESSORIES

\$11.48 ST0150

15' x 1½" VAC HOSE

VACPRO VACUUM HOSES

VAK41G	Gray
VAK41G/BK	Gray/Black
VAK41BK	Black
VAK41BL	Blue
VAK41BL/BK	Blue/Black
VAK41BL/R	Blue/Red
VAK41BL/Y	Blue/Yellow
VAK41BY/BK	Yellow/Black
VAK41OR	Orange
VAK41OR/BK	Orange/Black
VAK41PR	Purple
VAK41R	Red
VAK41R/BK	Red/Black
VAK41R/BL	Red/Blue
QTY OF 1-9 \$23.33	
BOX OF 10 21.7	

50' x 1½" VAC HOSE

KLEEN-RITE VACUUM HOSES

VAK43G	Gray
VAK43BK	Black
VAK43BL	Blue
VAK43BY	Bright Yellow
VAK43G/BK	Gray/Black
VAK43GG	Grass Green
VAK43OR	Orange
VAK43P	Purple
VAK43R	Red
VAK43R/BL	Red/Blue
\$73.00	



THE DUALER

VACUUM ACCESSORIES

- Provide customers with a new 2-option vacuum (conventional or crevice tool) 2" or 1½"
- Easily adapts to existing vacuum, increases vacuum revenue

\$125.66	DUALER
DE15092	Multi-color kit
DE15094	Hang Red Hose Here
DE15095	Hang Blue Hose Here
DE15096	Hang Gray Hose Here
DE15097	Hang Black Hose Here



ORDER DECALS SEPARATELY

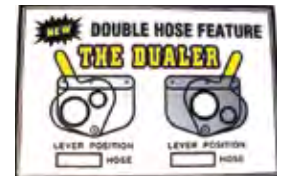

ORDER DECALS SEPARATELY

TO WATCH OUR VIDEO ON THE DUALER: VISIT OUR WEBSITE, OR SIMPLY SCAN THIS HANDY QR CODE WITH YOUR HAND-HELD MOBILE DEVICE:



VACUUMS & ACCESSORIES

KLEEN-RITE CORP.

VACUUM HOSES



KLEEN-RITE DURA-SLIDE PREMIUM VACUUM HOSE VACUUM HOSES

- Inner lining provides smooth air flow
- Durable construction and crush resistant design



DSH41BL/BK

DSH43R/BK

1½" x 15' HOSE		
\$20.32	DSH41BL/BK	Blue/Black
	DSH41BK	Black
	DSH41G	Gray
	DSH41R/BK	Red/Black

2" x 15' HOSE		
\$25.50	DSH45BL/BK	Blue/Black
	DSH45BK	Black
	DSH45G	Gray
	DSH45R/BK	Red/Black

1½" x 15' 2" HOSE		
\$24.92	DTH45R	Red
	DTH45G/BK	Gray/Black
	DTH45G	Gray
	DTH45BL/BK	Blue/Black
	DTH45BL	Blue
DTH45BK	Black	

1½" x 50' HOSE		
\$67.74	DSH43BL/BK	Blue/Black
	DSH43BK	Black
	DSH43G	Gray
	DSH43R/BK	Red/Black

2" x 50' HOSE		
\$85.00	DSH47BL/BK	Blue/Black
	DSH47BK	Black
	DSH47G	Gray
	DSH47R/BK	Red/Black



KRVH45R/BK

KRVH45BL/BK

KRVH43G

KLEEN-RITE VACUUM HOSE VACUUM HOSES



KLEEN-RITE .com

- Cost-efficient option for vacuums
- Made in the USA

1½" x 15' HOSE		
\$19.40	KRVH41BL/BK	Blue/Black
	KRVH41G	Gray
	KRVH41Y	Yellow
	KRVH41Y/BK	Yellow/Black
	KRVH41BK	Black
	KRVH41BL	Blue
	KRVH41R	Red
	KRVH41R/BK	Red/Black

2" x 15' HOSE		
\$23.35	KRVH45BK	Black
	KRVH45BL	Blue
	KRVH45BL/BK	Blue/Black
	KRVH45G	Gray
	KRVH45R	Red
	KRVH45R/BK	Red/Black
KRVH45Y/BK	Yellow/Black	

1½" x 50' HOSE		
\$59.62	KRVH43R	Red
	KRVH43BL/BK	Blue/Black
	KRVH43G	Gray
	KRVH43R/BK	Red/Black
	KRVH43BK	Black
	KRVH43BL	Blue

2" x 25' HOSE		
\$37.78	KRVH46BK	Black
	KRVH46BL	Blue
	KRVH46G	Gray
	KRVH46R	Red

2" x 50' HOSE		
\$77.56	KRVH47BK	Black
	KRVH47BL	Blue
	KRVH47BL/BK	Blue/Black
	KRVH47G	Gray
	KRVH47R	Red
	KRVH47R/BK	Red/Black

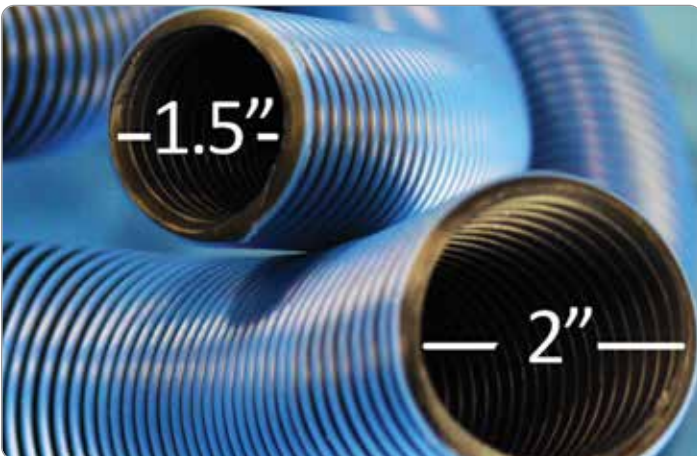

TAPERED VACUUM HOSE VACUUM HOSES

KLEEN-RITE .com

- KR tapered vacuum hoses are an excellent choice for car washes. Even as it's pulled to and from different cars, it resists snagging and is non-abrasive. Offering superior flexibility, it's great to run across the upholstery of any vehicle's interior. Nozzle not included with hose.
- 2" diameter to one end & 1½" on the other
- Easier to handle, reduced obstructions!
- 15' total length

VTH45BK/BK	Black
VTH45BL/BK	Blue/Black
VTH45G/BK	Gray/Black
VTH45R/BK	Red/Black
\$33.91	

VTH45R/R	Red
VTH45BL/BL	Blue
\$33.91	

NOZZLE NOT INCLUDED WITH HOSE

VACUUMS & ACCESSORIES

THE VACUUM PROSPECTOR



**THE PROSPECTOR
VACUUM CLEAN
OUT CANISTER**
VACUUM PROSPECTOR, LLC



You'll hit literal pay dirt after installing The Vacuum Prospector Clean Out Bucket! Ever stop and think about how much stuff gets sucked up by your car wash vacuums? Maybe you've even looked at all the various bits of debris when you clean out the canisters. While your vacuums are sucking up dirt, dog hair, and stale french fries, the vacs are also gobbling up errant coins that have fallen underneath your customers' seats. This means you are actually throwing away money each time you empty a vacuum!

The Vacuum Prospector Clean Out Bucket is an easy solution. It was developed by a car wash owner who was curious about the amount of coins lost to vacuums each year. After installing his prototype in vacuums, he was able to catch over \$400 in loose coins over the course of 6 months! The Vacuum Prospector has a unique design utilizing a false bottom and 162 individual holes. Each hole is slightly smaller than a dime, so no coins will escape.

Simply place the Clean Out Bucket inside your vacuum. When full, remove the bucket and unlatch the false bottom, exposing the unit's holes. Dirt, dust, lint, and other small debris will fall through the holes, leaving coins behind! It's like panning for gold - at your car wash.

- Out of the box compatibility with J.E. Adams vacuums
- False bottom keeps debris contained until you are ready to sift
- Each of the 162 holes is smaller than a dime so money will not escape away!
- Earn hundreds of dollars every year in coins that would have been thrown away!
- Triple handle design enables you to be hands on with the bucket, not the dirt
- Weight: 4 lbs.
- Dimensions: 18 $\frac{3}{4}$ " Diameter, 7 $\frac{1}{4}$ " Tall

\$46.99 VACP

MADE BY A CAR WASH OWNER FOR CAR WASH OWNERS!

BINS, CLEAN OUT BAGS & CANISTERS



OVAL VACUUM DIRT BIN
J.E. ADAMS

- Replacement dirt bin for oval J.E. Adams vacuums
- Durable Gray plastic
- 17.4" L x 10.65" W x 11.9" H

\$59.79 VAA8920-4



J.E. ADAMS CLEAN OUT BAG
J.E. ADAMS

- Use with J.E. Adams commercial car wash vacuums
- Black vinyl material

\$72.77 VAA8599



**VINYL CLEAN OUT BAG FOR
DOYLE/IVS**
GINSAN

- 18" diameter
- Manufactured for Doyle and IVS vacuum systems
- Black vinyl material

\$30.17 VAD1030



ADJUSTABLE CLEAN OUT BAG
CLEAN OUT BAGS

- Adjustment range from 18" to 20"
- Use with various commercial vacuum models, including J.E. Adams units

\$19.75 VA40011



RUBBER VAC DIRT CANISTER
HAMEL MANUFACTURING CO.

\$44.96 VDC10



VACUUM BAG BRUSH
ERIE BRUSH

- Polypropylene bristles - 8" diameter
- Extend filter bag use by breaking loose debris and objects
- $\frac{3}{8}$ " MPT for attachment to handles and extension rods

\$30.84 EB887901

VACUUMS & ACCESSORIES

DOOR GASKETS & FILTER BAGS



DOOR GASKETS VACUUM SUPPLIES

PRICE	PART #	DESCRIPTION	DIMENSIONS
\$8.89	VAD1040	IVS/Doyle	16" x 12" gasket, 61/4" circle cutout, 3/8" thick
\$4.93	VA8159	Adams/KR	11 3/4" x 14 3/4" O.D. 9 1/2" x 12" I.D. (adhesive on 1 side)
\$13.96	VA30049	1 pc. door Gasket G-2 vac	22" x 16" (adhesive on 1 side)
\$10.03	VAGC100	Coleman	3/16" thick, 12 x 17 3/8"



FILTER BAGS VACUUM SUPPLIES

PRICE	PART #	DESCRIPTION
\$10.35	VA40010	2/vac KR/Adams - 5 3/8" dia x 23 1/2" L (10 1/4" Flat)
\$15.00	VAD1000	Doyle/Industrial (4/vac) - 7" dia x 21 1/2" L
\$33.00	VA30194	G-2 (rectangular) (3/vac) - 10" L x 5" W x 21" L
\$19.17	VA30041	Old style Monorail (4/vac) - 7" dia x 26 1/2" L with super seal bottom, disc top with 1/2" strap
\$19.19	VAA8074	9200 Super Vac - 6 3/4" dia x 23" L
\$17.46	FMCP011	Fragramatics Combo Machine (4/vac) 7" dia x 17 3/4" L
\$19.55	VADHMV	D&H Maxi-vac (5/vac) - 7" dia x 22" L
\$16.83	VAC200	Coleman Replacement Bag - 6 1/2" dia x 23 1/2" L

VACUUM LATCHES

FOR J.E. ADAMS



DOOR CLASP - HINGE ONLY
VACUUM LATCHES

\$6.98 VA40028



STRIKER
VACUUM LATCHES

\$1.59 VA40029



LOOP ONLY IVS/DOYLE
VACUUM LATCHES

\$2.02 VAI104701



LATCH WITH LOOP IVS/DOYLE
VACUUM LATCHES

\$8.98 VAI104706



OLD STYLE DOOR CATCH 2 PIECE (MONORAIL/NAT'L STYLES)
VACUUM LATCHES

\$5.38 VA30039

FUSES



PRICE	PART #	DESCRIPTION
\$4.11	VAA5979D1	20 Amp Fuse
\$2.95	VAA5979D2	10 Amp Fuse
\$6.33	VAA5979D4	30 Amp Fuse
\$3.04	VAA5996010	10 Amp Inline Fuse
\$4.42	VAA5997001	Fuse Holder

MOTOR GASKETS



PRICE	PART #	DESCRIPTION	DIMENSIONS
\$1.25	VAGS036	Doyle/IVS	5" O.D. 2" I.D.
\$1.12	VA40021	Motor Bushing Gasket (8063) Adams/KR	6" O.D. 5" I.D. 1/4" Thick
\$1.25	VA40020	Motor Gasket Adams/KR (8057)	5 1/2" O.D. 4" I.D. 1/4" Thick
\$1.78	VAI106800	Screen for Intake Motor	-

VACUUMS & ACCESSORIES

FRAGRAMATICS® REPLACEMENT PARTS - MODEL EVD-2/EVD-3 FRAGRANCE DISPENSER



EVD DOOR DECAL
FRAGRAMATICS

\$50.66 FMDOR011



EVD-2 HOSE & HANDLE ASSEMBLY
FRAGRAMATICS

\$130.35 FMCAB018



EVD-3 HOSE & HANDLE ASSEMBLY
FRAGRAMATICS

\$131.46 FMCAB038



ATOMIZER
FRAGRAMATICS

\$38.58 FMVAC043



BRUSH WITH GASKET
FRAGRAMATICS

\$21.69 FMVAC076



FERRULES
(SOLD INDIVIDUALLY)
FRAGRAMATICS

\$2.72 FMCHA010



PICK-UP FOOT
FRAGRAMATICS

\$1.55 FMCHA018



FRAGRANCE VALVE
FRAGRAMATICS

\$95.21 FMCHA005



1/2 GALLON JUG
FRAGRAMATICS

\$4.59 FMCAB045



FRAGRAMATICS® REPLACEMENT PARTS - MODEL FV-3 VAC COMBO



VAC DOOR GASKET
FRAGRAMATICS

\$24.20 FMVAC032



1/2 GALLON JUG
FRAGRAMATICS

\$4.59 FMCAB045



FRAGRANCE VALVE
FRAGRAMATICS

\$95.21 FMCHA005



VISUAL FLUID SET
FRAGRAMATICS

\$14.67 FMVAC087



PICK-UP TUBES
FRAGRAMATICS

\$8.65 FMVAC106



CIRCULAR BULB
FOR DOME LIGHT
FRAGRAMATICS

\$38.81 FMVAC231



PUSH BUTTON FOR
FRAGRANCE HANDLE
FRAGRAMATICS

\$15.49 FMVAC110



HOSE ASSEMBLY
NO BRUSH & HANDLE
FRAGRAMATICS

\$83.52 FMVAC053



HOSE & HANDLE
ASSEMBLY
FRAGRAMATICS

\$147.75 FMVAC049



LEXAN FACEPLATE
FRAGRAMATICS

\$24.73 FMDOR009



ATOMIZER
FRAGRAMATICS

\$38.58 FMVAC043



24V
SOLID STATE RELAY
FRAGRAMATICS

\$92.51 FMVAC169



PICK-UP FOOT
FRAGRAMATICS

\$1.55 FMCHA018



FERRULES
(SOLD INDIVIDUALLY)
FRAGRAMATICS

\$2.72 FMCHA010



MOTOR FUSE
(ABC 10 AMP)
FRAGRAMATICS

\$1.09 FMVAC027



15 AMP FNM FUSES
FRAGRAMATICS

\$17.37 FMVAC059



25 AMP FNM FUSES
FRAGRAMATICS

\$18.20 FMVAC060



30 AMP FNM FUSES
FRAGRAMATICS

\$17.37 FMVAC058

VACUUMS & ACCESSORIES



FRAGRAMATICS® REPLACEMENT PARTS - CCD SHAMPOO MACHINE



FERRULES (SOLD INDIVIDUALLY)
FRAGRAMATICS

\$2.72 FMCHA010



PICK-UP FOOT
FRAGRAMATICS

\$1.55 FMCHA018



BRUSH WITH GASKET
FRAGRAMATICS

\$21.69 FMVAC076



COMPLETE HOSE & BRUSH ASSEMBLY
FRAGRAMATICS

\$195.56 FMCCD014

ON/OFF TOGGLE SWITCH
FRAGRAMATICS

\$14.63 FMVAC074



Car wash fragrance machines are a great choice for earning more revenue. Car wash customers are now looking for car washes that have fragrance machines. Keep yours up-to-date and properly maintained with the right parts!

The more options the better! Giving the customer more choices with your fragrance and shampoo machines will keep them satisfied. Stand-alone car wash shampoo machines are perfect for increasing the length of time a customer spends at your location and are perfect for maintaining your customer's cars. Making sure they are fully kitted with the proper parts and accessories is the best way to extend your unit's service life.

FRAGRAMATICS® REPLACEMENT PARTS - MODEL SVSR & SVSR-P VAC COMBO



MOTOR FUSE (ABC 10 AMP)
FRAGRAMATICS

\$1.09 FMVAC027



15 AMP FNM FUSES
FRAGRAMATICS

\$17.37 FMVAC059



25 AMP FNM FUSES
FRAGRAMATICS

\$18.20 FMVAC060



30 AMP FNM FUSES
FRAGRAMATICS

\$17.37 FMVAC058



FERRULES (SOLD INDIVIDUALLY)
FRAGRAMATICS

\$2.72 FMCHA010



PICK-UP FOOT
FRAGRAMATICS

\$1.55 FMCHA018



BRUSH W/ GASKET
FRAGRAMATICS

\$21.69 FMVAC076



VAC DOOR GASKET
FRAGRAMATICS

\$24.20 FMVAC032



HOSE ASSEMBLY NO BRUSH & HANDLE
FRAGRAMATICS

\$90.25 FMVAC080



CIRCULAR BULB FOR DOME LIGHT
FRAGRAMATICS

\$38.81 FMVAC231



PUMP TUBES
FRAGRAMATICS

\$14.31 FMVAC081 Spot Remover
\$14.31 FMVAC082 Shampoo



ON/OFF TOGGLE SWITCH
FRAGRAMATICS

\$14.63 FMVAC074



PICK-UP TUBING COMPLETE SET
FRAGRAMATICS

\$38.54 FMVAC056



24V SOLID STATE RELAY
FRAGRAMATICS

\$92.51 FMVAC169



FOAM GENERATOR
FRAGRAMATICS

\$56.99 FMVAC079

VACUUMS & ACCESSORIES

FRAGRAMATICS® REPLACEMENT PARTS - QUADRA SELECT-A-VAC



FERRULES
(SOLD INDIVIDUALLY)
FRAGRAMATICS

\$2.72 FMCHA010



PICK-UP FOOT
FRAGRAMATICS

\$1.55 FMCHA018



ON/OFF TOGGLE SWITCH
FRAGRAMATICS

\$14.63 FMVAC074



BRUSH W/ GASKET
FRAGRAMATICS

\$21.69 FMVAC076



CIRCULAR BULB FOR DOME LIGHT
FRAGRAMATICS

\$38.81 FMVAC231



HOSE & HANDLE ASSEMBLY
FRAGRAMATICS

\$147.75 FMVAC049

WITH
PUSH
BUTTON



PICK-UP TUBES
FRAGRAMATICS

\$8.65 FMVAC106



COMPLETE HOSE & BRUSH ASSEMBLY
FRAGRAMATICS

\$206.44 FMVAC077



FRAGRANCE VALVE
FRAGRAMATICS

\$95.21 FMCHA005



VAC DOOR GASKET
FRAGRAMATICS

\$24.20 FMVAC032



PUSH BUTTON FOR FRAGRANCE HANDLE
FRAGRAMATICS

\$15.49 FMVAC110



SPOT REMOVER TUBE
FRAGRAMATICS

\$14.31 FMVAC081



FRAGRAMATICS® REPLACEMENT PARTS - SAV SELECT-A-VAC



24V SOLID STATE RELAY
FRAGRAMATICS

\$92.51 FMVAC169



VISUAL FLUID SET
FRAGRAMATICS

\$14.67 FMVAC087



PICK-UP TUBES
FRAGRAMATICS

\$8.65 FMVAC106



HOSE & HANDLE ASSEMBLY
FRAGRAMATICS

\$147.75 FMVAC049



ATOMIZER
FRAGRAMATICS

\$38.58 FMVAC043



ON/OFF TOGGLE SWITCH
FRAGRAMATICS

\$14.63 FMVAC074



VAC DOOR GASKET
FRAGRAMATICS

\$24.20 FMVAC032



CIRCULAR BULB FOR DOME LIGHT
FRAGRAMATICS

\$38.81 FMVAC231



COMPLETE HOSE & BRUSH ASSEMBLY
FRAGRAMATICS

\$206.44 FMVAC077



FRAGRANCE SOLENOID
FRAGRAMATICS

\$95.21 FMCHA005



BRUSH W/ GASKET
FRAGRAMATICS

\$21.69 FMVAC076



MOTOR FUSE (ABC 10 AMP)
FRAGRAMATICS

\$1.09 FMVAC027

VACUUMS & ACCESSORIES



FRAGRANCES

FRAGRAMATICS® AUTO FRAGRANCES FRAGRANCES



BLUE LABEL & GREEN LABEL WATER BASED FRAGRANCES

WATER BASE	FRAGRANCE	OIL BASE
VSCFB003	Cinnamon	VSAFG003
VSCFB033	Citrus	VSAFG033
VSCFB026	Fresh-N-Clean	VSAFG026
VSCFB044	Ice	VSAFG044
VSCFB008	Jasmine	VSAFG008
VSCFB028	Leather	VSAFG028
VSCFB009	Lemon Lime	VSAFG009
VSCFB011	New Car	VSAFG011
VSCFB042	Orange Blast	VSAFG042
VSCFB014	Peach	VSAFG014
VSCFB015	Piña Colada	VSAFG015
VSCFB016	Pine Mist	VSAFG016
VSCFB021	Strawberry	VSAFG021
VSCFB029	Tropical Fruit	VSAFG029
VSCFB022	Vanilla	VSAFG022
VSCFB023	Wild Cherry	VSAFG023
\$22.50		\$30.50



FRAGRAMATICS® SHAMPOO & SPOT REMOVERS FRAGRANCES

\$14.00	VS750	Summer Shampoo - Ready to Use
\$25.96	VS825	Winter Shampoo
\$14.56	VS900	Spot Remover/ Summer Shampoo
\$25.96	VS975	Concentrated Shampoo
\$17.77	VS980	Spot Remover



WATER-BASED FRAGRANCE KLEEN-SCENT AUTO FRAGRANCES



- Water-based, non-flammable formula
- Available in 1 & 5 Gallon
- Freeze-proof to ~30°F

PRIVATE LABEL NOW AVAILABLE

ALSO AVAILABLE IN 5 GALLON

OIL-BASED FRAGRANCE KLEEN-SCENT AUTO FRAGRANCES



- Oil-based fragrance formula - will not stain
- Available in 1 & 5 Gallon
- Freeze-proof to ~0°F

PRIVATE LABEL NOW AVAILABLE

ALSO AVAILABLE IN 5 GALLON

LARGE

LEATHER

SMALL

PIÑA COLADA

FRAGRANCE	WATER BASE	OIL BASE	SMALL LABEL (2½" X ½")	LARGE LABEL (3½" X ¾")
Wild Cherry	VSKB1001	VSKG1001	VE0109WC	VE0110WC
Piña Colada	VSKB1002	VSKG1002	VE0109PC	VE0110PC
Lemon	VSKB1003	VSKG1003	VE0109LL	VE0110LL
Musk	VSKB1004	-	VE0109M	VE0110M
Pine Mlst	VSKB1005	VSKG1005	VE0109PM	VE0110PM
New Car	VSKB1006	VSKG1006	VE0109NC	VE0110NC
Strawberry	VSKB1007	VSKG1007	VE0109S	VE0110S
Spice Lite	VSKB1008	VSKG1008	VE0109SL	VE0110SL
Spearmint	VSKB1009	VSKG1009	VE0109SP	VE0110SP
Cinnamon	VSKB1110	VSKG1110	VE0109CN	VE0110CN
Baby Powder	VSKB1111	VSKG1111	VE0109BP	VE0110BP
Jasmine	VSKB1112	VSKG1112	VE0109J	VE0110J
Vanilla	VSKB1115	VSKG1115	VE0109V	VE0110V
Apple Blossom	VSKB1117	-	VE0109AB	VE0110AB
Tropical Fruit	VSKB1123	VSKG1123	VE0109TF	VE0110TF
Fresh-N-Clean	VSKB1125	VSKG1125	VE0109FC	VE0110FC
Leather	VSKB1126	VSKG1126	VE0109L	VE0110L
Peach	VSKB1127	VSKG1127	VE0109P	VE0110P
Citrus	VSKB1129	VSKG1129	VE0109C	VE0110C
Spring Floral	VSKB1131	VSKG1131	VE0109SF	VE0110SF
Night Frost	VSKB1132	VSKG1132	VE0109NF	VE0110NF
PRICE	\$13.35	\$20.59	\$0.25	\$0.42



RTU = Ready To Use

KLEEN-RITE CARPET MACHINE SHAMPOOS SHAMPOOS

**5 GALLON
BEST VALUE!**

\$8.35	VSK750	1 Gallon - RTU	Summer Shampoo	\$12.23	VSK910	1 Gallon - RTU	Summer Carpet Protectant
\$13.36	VSK975	1 Gallon - Makes 6 Gallons	Summer Concentrate	\$17.73	VSK915	1 Gallon - RTU	Winter Carpet Protectant
\$12.12	VSK980	1 Gallon - RTU	Summer Spot Remover	\$36.46	VSK5750	5 Gallon - RTU	Summer Carpet Shampoo
\$10.86	VSK900	1 Gallon - RTU	Summer Shampoo Plus Spot Remover	\$58.99	VSK5825	5 Gallon - RTU	Winter Shampoo
\$14.83	VSK905	1 Gallon - RTU	Winter Spot Remover - Good to 5°F	\$51.53	VSK5975	5 Gallon - Makes 30 Gallons	Summer Shampoo Concentrate
\$15.57	VSK825	1 Gallon - RTU	Winter Shampoo - Good to 5°F	\$98.42	VSK5WC	5 Gallon - Makes 30 Gallons	Winter Shampoo Concentrate
\$27.60	VSKWC	1 Gallon - Makes 4 Gallons	Winter Concentrate - Good to 5°F	\$48.96	VSK5980	5 Gallon - RTU	Spot Remover

VACUUMS & ACCESSORIES

VACUUM MOTORS



KLEEN-RITE.com



VMK19 VAC MOTOR

KLEEN-RITE MOTORS

- 120 Volt AC, 2-stage vacuum motor
- Wound, tested, and assembled in the USA
- 89" of water sealed vacuum (typical)
- 9" power leads with quick-connect terminals
- UL / CUL Listed & RoHS / REACH compliant
- 5.7" bypass, peripheral exhaust configuration
- 308 peak air watts (typical)
- 101 Cubic Feet per Minute open flow (typical)
- Double ball bearing for added durability

\$36.50 VMK19

KLEEN-RITE VAC MOTOR BRUSH REPLACEMENT KIT

KLEEN-RITE MOTORS

- 2 replacement brush assemblies
- Brush replacement gauge
- Instruction sheet for changing brushes

\$5.99 VMKBRUSH



FRAGRAMATICS TURBO MOTOR

FRAGRAMATICS



- 120 Volt, 2-stage vacuum motor
- 1500 hour motor brush life
- Dimensions: 10" x 10" x 10"

\$88.71 FMVAC820



VMK6565

KLEEN-RITE MOTORS

KLEEN-RITE.com

- 120 Volt AC, 3-stage vacuum motor
- Wound, tested, and assembled in the USA
- 127" of water sealed vacuum (typical)
- Patented bearing moisture protection
- Double ball bearing for added durability
- 5.7" bypass, tangential exhaust configuration
- 430 peak air watts (typical)
- 99 Cubic Feet per Minute open flow (typical)
- 9" power leads with quick-connect terminals
- UL / CUL Listed & RoHS / REACH compliant

\$92.48	VMK6565	Motor
\$5.99	VMKBRUSH	Brush



VMK6309

KLEEN-RITE MOTORS

KLEEN-RITE.com

- 120 Volt AC, 1-stage vacuum motor
- Wound, tested, and assembled in the USA
- 72" of water sealed vacuum (typical)
- 9" power leads with quick-connect terminals
- UL / CUL Listed & RoHS / REACH Compliant
- 5.7" thru-flow configuration
- 269 peak air watts (typical)
- 111 Cubic Feet per Minute open flow (typical)
- Double ball bearing for added durability

\$50.94	VMK6309	Motor
\$5.99	VMKBRUSH	Brush



USE WITH AIR SHAMMY!

VMK4MP

KLEEN-RITE MOTORS

KLEEN-RITE.com

- 120 Volt AC, 2-stage vacuum motor
- 5.7" bypass, tangential exhaust configuration
- 441 peak air watts (typical)
- 106 Cubic Feet per Minute open flow (typical)
- 9" power leads with quick-connect terminals
- UL / CUL Listed & RoHS / REACH compliant
- Optional 220-240 Volt AC version available
- Wound, tested and, assembled in the USA
- 112" of water sealed vacuum (typical)
- Patented bearing moisture protection
- Double ball bearing for added durability

\$63.85	VMK4MP	120V	\$65.00	VMK5MP	220V
\$5.99	VMKBRUSH	Brush	\$6.90	VMKB1015	Brush

VACUUMS & ACCESSORIES

KLEEN-RITE CORP.

KLEEN-RITE VACUUM MOTORS



VMK6765

KLEEN-RITE MOTORS

- 120 Volt AC, 3-stage vacuum motor
- Wound, tested, and assembled in the USA
- 143" of water sealed vacuum (typical)
- Patented bearing moisture protection
- Double ball bearing for added durability
- 5.7" bypass, tangential exhaust configuration
- 521 peak air watts (typical)
- 107 Cubic Feet per Minute open flow (typical)
- 9" power leads with quick-connect terminals
- UL / CUL Listed & RoHS / REACH compliant

\$87.77	VMK6765	Motor
\$5.96	VMKBRUSH	Brush



VMK09

KLEEN-RITE MOTORS

- 220-240 Volt AC, 2-stage vacuum motor
- Wound, tested, and assembled in the USA
- 126" of water sealed vacuum (typical)
- Patented bearing moisture protection
- Double ball bearing for added durability
- 5.7" bypass, tangential exhaust configuration
- 537 peak air watts (typical)
- 123 Cubic Feet per Minute open flow (typical)
- 9" power leads with quick-connect terminals
- UL / CUL Listed & RoHS / REACH compliant

\$78.74	VMK09	Motor
\$6.90	VMKB1015	Brush



VMK0963470

KLEEN-RITE MOTORS

- 120 Volt AC, 2-stage vacuum motor
- Wound, tested, and assembled in the USA
- 117" of water sealed vacuum (typical)
- Patented bearing moisture protection
- Double ball bearing for added durability
- 5.7" bypass, tangential exhaust configuration
- 422 peak air watts (typical)
- 105 Cubic Feet per Minute open flow (typical)
- 9" power leads with quick-connect terminals
- UL / CUL Listed & RoHS / REACH compliant

\$61.29	VMK0963470	Motor
\$5.96	VMKBRUSH	Brush



VMK6471

KLEEN-RITE MOTORS

- 120 Volt AC, 2-stage vacuum motor
- Wound, tested, and assembled in the USA
- 115" of water sealed vacuum (typical)
- Patented bearing moisture protection
- Double ball bearing for added durability
- 5.7" bypass, peripheral exhaust configuration
- 474 peak air watts (typical)
- 116 Cubic Feet per Minute open flow (typical)
- 9" power leads with quick-connect terminals
- UL / CUL Listed & RoHS / REACH compliant

\$77.59	VMK6471	Motor
\$5.96	VMKBRUSH	Brush



VMK6392

KLEEN-RITE MOTORS

- 120 Volt AC, 2-stage vacuum motor
- Wound, tested, and assembled in the USA
- 89" of water sealed vacuum (typical)
- Patented bearing moisture protection
- Double ball bearing for added durability
- 5.7" bypass, tangential exhaust configuration
- 290 peak air watts (typical)
- 98 Cubic Feet per Minute open flow (typical)
- 9" power leads with quick-connect terminals
- UL / CUL Listed & RoHS / REACH compliant

\$59.65	VMK6392	Motor
\$5.96	VMKBRUSH	Brush

VACUUMS & ACCESSORIES

KLEEN-RITE VACUUM MOTORS



VMK135 MOTOR

KLEEN-RITE MOTORS

KLEEN-RITE.com

- Qui-EM quiet fan system
- 5.7" bypass, peripheral exhaust configuration
- 286 peak air watts (typical)
- 94 Cubic Feet per Minute open flow (typical)
- Double ball bearing for added durability
- 120 Volt AC, 2-stage vacuum motor
- Wound, tested, and assembled in the USA
- 90" of water sealed vacuum (typical)
- 9" Power leads with quick-connect terminals
- UL / CUL Listed & RoHS / REACH compliant

\$57.06	VMK135	Motor
\$5.96	VMKBRUSH	Brush



LOOKING FOR A QUIET OPERATION...

In addition to the Kleen-Rite branded vacuum motors being wound, tested and assembled in the USA for over 20 years, the VMK135 version has the unique Qui-EM fan system that offers a significant reduction in Sound. The VMK135 model offers up to a 6 dBA reduction in sound power when compared to the highly popular VMK19 model. If your environment would benefit from quiet operation of your vacuum system, consider upgrading to the VMK135.

VACUUM MOTOR BRUSHES & ACCESSORIES



KLEEN-RITE 120 VOLT VAC MOTOR BRUSH KIT

VACUUM BRUSHES

- Each kit includes 2 brush assemblies
- 1 brush replacement gauge
- Instruction sheet

\$5.96 **VMKBRUSH**



AMETEK CARBON BRUSHES 120 V - SET OF 2

VACUUM BRUSHES

- Replaces old KR part # VALP3347

\$5.38 **VAL833474-50**



LAMB VAC MOTOR BRUSH

VACUUM BRUSHES

- For VAL6336 & VAL6207

\$3.22 **VA30034**



AMETEK CARBON BRUSHES

VACUUM BRUSHES

- For 6565, 6471, 6472 Ametek motors

\$4.90 **VAL33392-17**



VACUUM CLEANER TEST GAUGE

VACUUM ACCESSORIES

- 2½" steel gauge with a rubber adapter designed to fit easily over the intake of a vacuum cleaner hose
- Metal diaphragm with an easy to read white dial with black numerals and is scaled from -200 to 0" of water vacuum
- Through-the-dial reset screw which simplifies the adjustment of the gauge when being tested against a vacuum source of a known value

\$59.68 **GAV200**



VACUUM CHECK

VACUUM ACCESSORIES



- Prevents suction loss in case of vacuum motor failure
- Instantly seals off failed motors retaining up to 90% of suction
- Direct fit - no vacuum modifications
- Does not interfere with normal operation
- Universal design fits any vertical motor vacuum with 3" motor hole (requires 1 per motor)
- VC002 adaptor for old style vacuums available
- Made with pride in the USA

\$14.85	VC001	Vac Check
\$2.00	VC002	Gasket for Vacuums with Single Doors

VACUUMS & ACCESSORIES



VAL9414 LAMB DUAL BALL MOTOR

AMETEK MOTORS

- Black motor housing
- Dual ball bearings
- 5.7" fan diameter
- 2-stage blower
- Peripheral air discharger
- Skeleton frame
- 120V at 8.0 amp
- 1.6 HP
- Operating Temp -32° F - 104° F
- 94.0 CFM
- 50/60 Hz

\$46.08	VAL9414	Motor
\$5.38	VAL833474-50	Brush



Commercial vacuum cleaners rely solely on the proper motors to make them run, and no other name in the industry compares to Ametek. They produce replacement motors, repair parts and brushes for a large selection of different models. Used widely in car wash and commercial industrial units. Built to last and handle the rigors of continual use, you can't go wrong by choosing a product with the brand name Ametek.



VAL9413 LAMB DUAL BALL MOTOR

AMETEK MOTORS

- Patented ACUSTEK quiet bypass
- 84.9" vacuum (H2O sealed) 60/50 Hz
- Max amps 8.0
- All-position mounting
- Max. air watts 255
- Fan diameter 5.7"

\$90.28	VAL9413	Motor	NEW STYLE QUIET MOTOR
\$5.38	VAL833474-50	Brush	

SAME SIZE AS THE GSE VAC MOTOR



VAL12315 ETERNITY BRUSH MOTOR

AMETEK MOTORS

- 2 stage 5.7" diameter
- "Eternity" brush system - up to twice the brush life!
- New generation bearing protection system
- Peripheral air discharge
- UL recognized
- 120V
- Provision for grounding

\$99.16	VAL2315	Motor
\$9.92	VALP8505967-50	Brush

UP TO 3X THE BRUSH LIFE!



VAL6309 MOTOR

AMETEK MOTORS

- Component UL recognized
- Designed to handle clean, dry filtered air only
- One ball/one sleeve bearing
- 1 fan stage, 1 speed
- Provision for grounding
- 5.7" diameter
- Open frame construction
- 120V
- Thru-flow

\$84.25	VAL6309	Motor
\$4.67	VALP33400-13	Brush



VAL5334 MOTOR

AMETEK MOTORS

- Use for central vacuums, car wash vacuums, commercial industrial vacuum systems
- Dual ball bearings
- Provision for grounding
- Tangential air discharge
- UL/CSA Recognized
- Two fan stages
- Bypass
- 7.2" diameter
- 120V

\$238.20	VAL5334	Motor
\$5.10	VALP33415	Brush



VAL6392 MOTOR

AMETEK MOTORS

- Handles clean air only
- Provision for grounding
- Open frame construction
- Double ball bearings
- Bypass
- 120V
- Plastic fan-end bracket
- Tangential discharge
- 2 fan stage, 1 speed
- 5.7" diameter

\$85.35	VAL6392	Motor
\$5.00	VALP33384	Brush

TO WATCH A TOM'S WAY VIDEO ON HOW TO CHANGE YOUR VAC MOTOR BRUSHES VISIT OUR WEBSITE, OR SIMPLY SCAN THIS HANDY QR CODE WITH YOUR HANDHELD MOBILE DEVICE:



ALL OTHER LAMB MOTORS AVAILABLE BY SPECIAL ORDER!

VACUUMS & ACCESSORIES

AMETEK®

AMETEK®



ALL OTHER LAMB MOTORS AVAILABLE BY SPECIAL ORDER!



VAL6336 MOTOR

AMETEK MOTORS

- Two fan stages
- 120V
- Peripheral air discharge
- Use for central vacuums, commercial vacuums, and car wash vacuums
- Bypass
- UL/CSA Recognized
- Plastic fan end bracket
- 5.7" diameter
- Ball/ball bearings
- 8.0 amp
- Provision for grounding

\$64.00	VAL6336	Motor
\$3.22	VA30034	Brush



VAL6757 QUIET MOTOR

AMETEK MOTORS

- Use in central vacuums, commercial vacuums, and car wash vacuums
- Patented ACUSTEK® quiet bypass
- Two fan stages
- UL/CSA recognized
- Plastic fan end bracket
- Patented air seal bearing protection
- 120V
- Dual ball bearings
- 5.7" diameter
- Provision for grounding
- Epoxy painted fan case

\$80.03	VAL6757	Motor
\$5.00	VALP33384	Brush

VAL6471 MOTOR

AMETEK MOTORS

- Patented air seal bearing protection, U.S. patent #4,088,424, that draws air from the outside and prevents bearings from becoming wet
- Epoxy painted fan case improveS corrosion resistance
- Component recognized by UL
- 2 fan stages, 1 speed
- 5.7" diameter
- Plastic fan-end bracket
- 120V
- Provision for grounding
- Double ball bearings
- Bypass
- Open frame construction

\$135.34	VAL6471	Motor
\$4.90	VAL33392-17	Brush



VAL6565 QUIET MOTOR

AMETEK MOTORS

- Patented air seal bearing protection, U.S. patent #4,088,424, that draws air from the outside and prevents bearings from becoming wet
- Component recognized by UL
- Epoxy painted fan case to improve corrosion resistance
- 5.7" diameter
- 3 fan stage, 1 speed
- Provision for grounding
- Open frame construction
- Bypass
- Plastic fan end bracket
- Double ball bearings
- 120V
- Tangential discharge

\$131.63	VAL6565	Motor
\$4.90	VAL33392-17	Brush



VAL9411 MOTOR

AMETEK MOTORS

- Great for vacuums/intermittent duty applications
- Thru-flow discharge
- 1 stage, 1 speed
- 5.7" diameter
- Max air watts: 190
- UL Listed & CSA Certified
- 120V
- Max amps: 6.8

\$99.87	VAL9411	Motor
\$5.38	VAL833474-50	Brush



VAL6119 MOTOR

AMETEK MOTORS

- Use in central vacuums, steam carpet cleaners, commercial/industrial vacuum systems
- Provision for grounding
- Epoxy coated fan system
- Bypass
- 120V
- Tangential air discharge
- Three fan stages
- 7.2" diameter
- Dual ball bearings

\$331.14	VAL6119	Motor
\$5.10	VALP33415	Brush



VACUUMS & ACCESSORIES

WASTE RECEPTACLES & ACCESSORIES



45 GALLON EXPANDED STEEL STREET BASKET

RUBBERMAID



- Designed to withstand constant harsh weather
- See-through design ideal for public high traffic areas
- Hot dipped galvanized steel and powder coated
- Tapered design permits nesting for easy storage
- Reinforced curled edges and bottom drain holes

PRICE	PART #	DIMENSIONS
\$375.31	WRSBR52E-BK	33" H x 24" W



GLUTTON® BROWN 56 GALLON CONTAINER

RUBBERMAID



- Largest capacity container for indoor/outdoor use
- Built to withstand extreme weather and handling
- Hold down base can be filled with sand or water to provide added stability and security
- Perfect for large crowds and high-traffic areas

\$255.00	WR256B00-BRN	Container Only
\$250.00	WR256V00-BRN	Hooded Top - No Doors

CONTAINER AND HOODED TOPS SOLD SEPARATELY



MARSHALL® 15 GALLON CLASSIC WASTE CONTAINER

RUBBERMAID



- Textured finish helps minimize appearance of surface scratches
- Designed for indoor and protected outdoor environments such as atriums and indoor pools
- Doors on both sides provide easy access for trash disposal
- Rugged construction resists dents and scratches
- Included retainer hardware secures and conceals can liners

\$222.00	WR816088BK	Black
-----------------	-------------------	-------



TRASH COVER HOLDER

TRASH ACCESSORIES

- 4 stainless steel channel mat clamps
- Stainless steel bolts and ships unassembled
- Included with all units

\$355.03	TCMH18	Retrofit mat holder (top only) for 18" hole bases
\$528.18	TCMH1828COM	28" x 28" base with 18" hole complete set
\$506.56	TCMH1830COM	30" x 30" base with 18" hole complete set
\$482.03	TCMH1328COM	28" x 28" base with 13" hole complete set



BUCKET BRACKET

TRASH ACCESSORIES

- Convert your 5-gallon bucket into a trash can for in-bay or island use
- Stainless steel trash bucket holder

\$41.58	BHSS
----------------	-------------

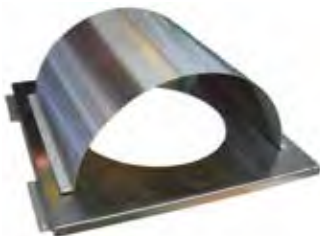

STAINLESS STEEL TRASH ENCLOSURE

TRASH ACCESSORIES

- Assembled: must be shipped freight
- Unassembled: can be shipped UPS

\$214.30	TC1328	28" x 28" - 13" Hole
\$300.40	TC1828	28" x 28" - 18" Hole
\$275.69	TC1830	30" x 30" - 18" Hole



HI DENSITY POLY CAN LINERS

FORDION JANITORIAL SUPPLIES

- Natural color
- High density for maximum efficiency

PRICE	PART #	SIZE	MICRONS	CAPACITY	CASE QTY
\$15.25	WR610001	24"L x 24"W	6	7-10 Gal.	1,000
\$28.22	WR610002	60"L x 36"W	12	55 Gal.	200

DON'T FORGET TO ORDER CAN LINERS!

We have can liners available in a wide range of capacities. From 7 gallons to 55 gallons, we have exactly what you need!

VACUUMS & ACCESSORIES

WASTE RECEPTACLES, ACCESSORIES & SAFETY CONES



GARBAGE BIN

AHEARN SIGNS



- 32-gallon plastic bin
- 22" W x 28" H (with lid)
- **INCLUDES:** 3-piece decal set - 2 side decals and 1 lid decal
- **CUSTOMIZATION OPTIONS:**
 - Customer sends logo and wording
 - Ahearn creates artwork for approval

CALL	TR-BL	Blue
	TR-BL-C	Blue Custom
	TR-RE	Red
	TR-RE-C	Red Custom
	TR-YE	Yellow
	TR-YE-C	Yellow Custom



ALADDIN SELF-EXTINGUISHING SMOKERS POLE

RUBBERMAID



- Weather resistant and steel liner for easy disposal
- Oxygen reducing fluted design extinguishes cigarettes and is fire-safe
- Dimensions: 16" D X 38¾" H

\$240.35 **WRR1639EHGR**



SMOKER'S POLE

RUBBERMAID



- Its size reduces obstructions in high traffic areas
- Weather-resistant, fire-safe aluminum
- Features recessed extinguishing screen
- Dimensions: 12¾" W x 41" H

\$287.63 **WRR1SM**



GROUNDKEEPER® SMOKER'S STATION

RUBBERMAID



- Designed to handle all weather conditions with a resin construction
- Hygienic, easy-to-service steel canister
- Restricted opening shields waste from view, weather, and flow of oxygen
- Dimensions: 12¼" W x 39½" H

\$138.00 **WR257088**



NIFTYNABBER PRO HAND SQUEEZE TRASH GRABBER

UNGER

- Eliminates the need to bend over or stoop to pick up garbage off the ground
- Is squeezed with all fingers to greatly reduce hand fatigue
- Great tool for car washes, store lots, parks, highways, and other areas where trash collects
- 36" length | 4¼" grabber opening

\$45.62 **NN900**



COLLAPSIBLE REFLECTIVE TRAFFIC CONE

SAFETY ITEMS

- Includes add-on rubber base that adds weight
- Built-in reflecting strips
- Add signs, reflectors, or lights to on top
- 16 lb. black rubber base adds stability
- Offset handle for easy transport and movement
- Orange cone is 48" high

\$39.59	SI0870	Complete Cone & Base
\$23.91	SI0870C	Cone Only
\$16.45	SI0870B	Base Only

VACUUMS & ACCESSORIES

SAFETY CONES & CLEARANCE BARS



CONE SLEEVE COVER

AHEARN SIGNS



- 6 pack
- For 28" traffic cones
- **CONES SOLD SEPARATELY**
- **CUSTOMIZATION OPTIONS FOR ITEM COSL-JUM:**
 - Name of your wash, unlimited wash membership price per month, products featured in your wash

CALL	COSL-JUM	Unlimited Wash Plans
	COSL-FTO	Please Return Towels
	COSL-BCS	Bug Scrub
	COSL-GUN	Unlimited Wash Club
	COSL-GAP	Manager's Special



TRAFFIC CONES

SAFETY ITEMS

- Highly durable PVC that is capable of withstanding high-speed impacts and heavy industrial use. Multiple cones can be conveniently stacked inside each other for easy storage when not in use.
- Dimensions: 28" Height x 15" Base Diameter x 11" Cone Diameter

\$22.55	SFT2000	Solid
\$21.11	SFT2000-R	With Reflective Tape

New!



CLEARANCE STRUCTURES

POST GUARD



- 10' 2" H x 9' 7-15/16" W, fixed, power coated chain, and 4 J-Bolts included

PRICE	PART #	FIXED - NO HINGE
\$812.00	PG300-Y	Yellow
\$812.00	PG300-S	Silver
\$812.00	PG300-BK	Black

PRICE	PART #	WITH HINGE
\$1,007.49	PG300-Y-H	Yellow, with Hinge
\$1,007.49	PG300-S-H	Silver, with Hinge
\$1,007.49	PG300-BK-H	Black, with Hinge



PLEASE NOTE: PRODUCTS ARE NON-CANCELABLE/NON-RETURNABLE



PLEASE NOTE: IDEAL SHIELD PRODUCTS ARE NON-RETURNABLE

CLEARANCE BAR

IDEAL SHIELD



- Durable plastic bar = no maintenance and no painting!
- Easy installation with eye bolts and lettering included
- Variety of colors and sizes available

PRICE	PART #	LENGTH	WITH LETTERING
\$94.78	CB01	78"	Yes Specify Height
\$95.69	CB02	78"	No

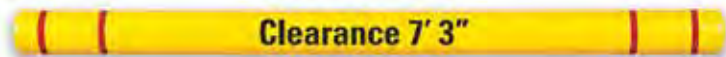

CLEARANCE BARS

POST GUARD



- The Height Guard Clearance Bar is made of HDPE plastic, has 2-3M reflective stripes on each end and includes the graphics kit, "CLEARANCE" with 2 sets of numbers

\$111.25	PG4580	4.5 X 80 Height Guard, yellow w/black graphics & red tape
\$111.25	PG4580S	4.5 x 80 Height Guard - Specify Color*
\$138.75	PG0780	7 x 80 Height Guard, yellow w/black graphics & red tape
\$135.00	PG0780S	7 x 80 Height Guard - Specify Color*

WHEN ORDERING, SPECIFY BAR COLOR:

Yellow, White, Blue, Royal Blue Red, Black, Gray, Orange, Green, Brown, Beige

SPECIFY TAPE COLOR: White, Red, Black SPECIFY GRAPHIC COLOR: Black or White

PLEASE NOTE: POST GUARD® PRODUCTS ARE NON-CANCELABLE / NON-RETURNABLE

VACUUMS & ACCESSORIES

BOLLARD COVERS

HEAVY DUTY BOLLARD COVERS

IDEAL SHIELD



DURABLE PRODUCTS. MAINTENANCE FREE. NEVER PAINT AGAIN!

- Ideal Shield bollard covers save you time, money, and cost of maintenance by eliminating the need to paint! We offer more colors, unique styles, sizes, and custom options. Simply slide over existing posts for quick and easy installation. Invest in Ideal Shield for a brand new look for years to come!
- Durable plastic cover = no maintenance and no painting!
- Fits all pipe sizes 3" - 12". Available in any color!
- Quick and easy installation
- Custom options and logos available



PRICE	PART #	DIA. X LENGTH	COLOR
\$48.39	PC352BL		Blue
\$48.39	PC352R	3-3 1/2" x 52"	Red
\$48.39	PC352Y		Yellow
\$48.39	PC360R	3-3 1/2" x 60"	Red
\$48.39	PC360Y		Yellow
\$48.39	PC42S	Square Pole Cover	Specify
\$48.39	PC452BL		Blue
\$48.39	PC452G		Green
\$48.39	PC452OR	4-4 1/2" x 52"	Orange
\$48.39	PC452R		Red
\$48.39	PC452W		White
\$48.39	PC452Y		Yellow
\$52.54	PC460BL	4-4 1/2" x 60"	Blue
\$52.54	PC460R		Red
\$52.54	PC460Y		Yellow
\$48.39	PC552BL		Blue
\$48.39	PC552G		Green
\$48.39	PC552R	5-5 9/16" x 52"	Red
\$48.39	PC552Y		Yellow
\$52.54	PC560BL	5-5 9/16" x 60"	Blue
\$52.54	PC560R		Red
\$52.54	PC560W		White
\$52.54	PC560Y		Yellow

PRICE	PART #	DIA. X LENGTH	COLOR
\$48.39	PC652BK		Black
\$50.69	PC652BL		Blue
\$48.38	PC652G	6 - 6 5/8" x 52"	Green
\$48.39	PC652R		Red
\$48.39	PC652Y		Yellow
\$71.88	PC665BL		Blue
\$71.88	PC665R	6 - 6 5/8" x 65"	Red
\$85.72	PC665Y		Yellow
\$86.09	PC684Y	6" x 84"	Blue
\$66.35	PC756BL		Blue
\$66.35	PC756R	7 - 7 9/16" x 56"	Red
\$66.35	PC756Y		Yellow
\$88.47	PC860R	8 - 8 5/8" x 60"	Red
\$72.89	PC860Y		Yellow

REFERENCE CHART

OD = Outside Diameter • ID = Inside Diameter

PIPE OD	SLEEVE OD	PIPE CIRC.	PIPE	IDEAL SLEEVE
3.5"	3 3/8"	11"	3"	3"
4"	4 1/8"	12 1/2"	3 1/2"	3 1/2"
4.5"	4 7/8"	14"-15"	4"	4"
5.563"	5 7/8"	17 1/2"	5"	5 1/2"
6.625"	6 7/8"	20 1/2"-21 1/2"	6"	6"
7.5"	7 7/8"	24"	7"	7 1/2"
8.625"	8 7/8"	27"-27 1/2"	8"	8"
10.75"	10 7/8"	34"-34 1/2"	10"	10"
12.75"	12 5/8"	37 5/8"	12"	12"

EASY INSTALL:

Simply place the included single-sided adhesive tape on existing pole, then slide the new bollard cover over it!



PLEASE NOTE: IDEAL SHIELD® PRODUCTS ARE NON-RETURNABLE

NEVER PAINT AGAIN!

The plastic bollard sleeve provides you with a new look that will last for years to come and you will never have to paint again! The product is manufactured from 100% recyclable plastic. These bollards are ideal for parking garages, car washes, bank drive thrus, apartment buildings, rental parking lots and more!



ECONOMY BOLLARD COVERS

VALUE LINE



ONLY TO BE USED ON POLES WITH A 14"-15" CIRCUMFERENCE

\$34.30	KRV460Y	4"-4 1/2" x 60"	Yellow
\$34.30	KRV460B	4"-4 1/2" x 60"	Blue
\$34.30	KRV460R	4"-4 1/2" x 60"	Red
\$34.30	KRV460W	4"-4 1/2" x 60"	White

ONLY TO BE USED ON POLES WITH A 20.5"-21.5" CIRCUMFERENCE

\$38.99	KRV660Y	6 5/8" x 60"	Yellow
\$38.99	KRV660B	6 5/8" x 60"	Blue
\$38.99	KRV660R	6 5/8" x 60"	Red
\$38.99	KRV660R	6 5/8" x 60"	White

WHICH SIZE BOLLARD COVER DO I NEED?

Please make sure to measure your existing poles before placing an order for bollard covers. Please see notes on specific products when ordering!

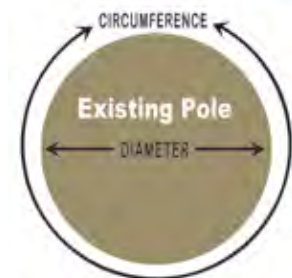

HAVE CIRCUMFERENCE SIZE READY WHEN PLACING YOUR ORDER.

VACUUMS & ACCESSORIES

POST GUARD® POLE COVERS

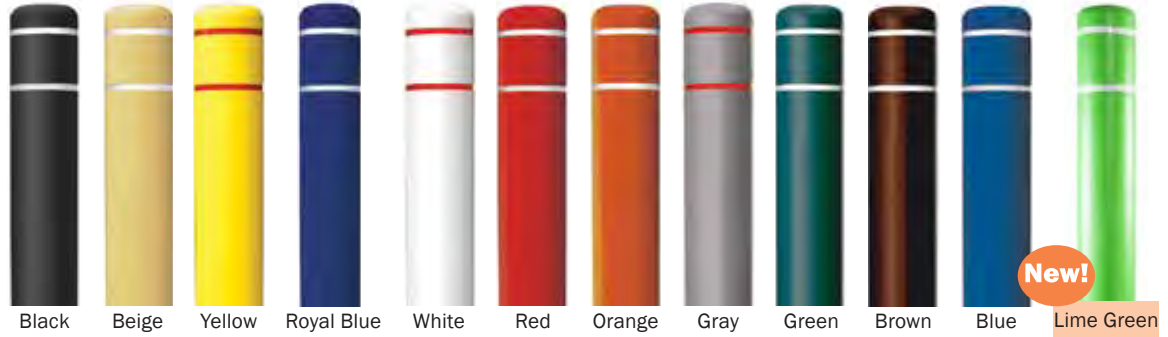

ROUND POLE COVERS

- Whether you call them post covers, bollard covers or post sleeves, they are available in a wide variety of colors. Post Guard is designed with smooth sides and two recessed reflective stripes near the rounded top.

PRICE	PART #	SIZE	POLE COVER COLOR	TAPE COLOR
\$29.50	PG4552	4½" x 52"	Yellow, Gray, White, Orange, Blue, Green, Red, Brown, Black, Beige, Royal Blue, Lime Green	Red, White, Yellow*, Black*, Green*, Blue*
\$33.33	PG4564	4½" x 64"	Yellow, Gray, White, Orange, Blue, Green, Red, Brown, Black, Beige, Royal Blue**	Red, White, Yellow*, Black*, Green*, Blue*
\$37.18	PG0760	7" x 60"	Yellow, Gray, White, Orange, Blue, Green, Red, Brown, Black, Beige, Royal Blue	Red, White, Yellow*, Black*, Green*, Blue*
\$74.35	PG8772	8⅞" x 72"	Yellow, Red, White, Gray, Blue, Black	Red, White, Yellow*, Black*, Green*, Blue*
\$91.02	PG1060	10⅞" x 60"	Yellow	Red, White, Yellow*, Black*, Green*, Blue*

* These tape colors are available at an additional **\$4 PER SLEEVE** and may require a slightly longer lead time



SQUARE POLE COVERS

- Square Post Guard covers are designed with crisp and clean lines. The two red reflective tape stripes are recessed into the high quality yellow polyethylene cover.
- Solid and thicker
- Durable surface helps prevent scuffing
- Top UV package assures longer fade resistance

PRICE	PART #	SIZE	COVER	TAPE
\$73.21	PG4545S	4½" x 4½" x 55"	Yellow	Red
\$83.93	PG6565S	6½" x 6½" x 55"	Yellow	Red



BOLT DOWN BOLLARDS

- Save time installing these surface mounted bollards!
- No core drilling or excavation needed
- Weld-on cap • 1 Year Warranty

\$184.62	PG0436	4" X 36" w/ 8" X 8" Plate, Yellow Powder Coated
\$225.00	PG0442	4" x 42" w/ 8" x 8" Plate, Yellow Powder Coated
\$365.00	PG0642	6" x 42" w/ 10" x 12" Plate, Yellow Powder Coated
\$30.00	PGBOLTS*	Concrete Anchor Set of 4

* Please note that these are not included with your bollards and must be purchased separately

HELPFUL HINT

WHAT SIZE POST GUARD COVER DO I NEED?

Use this handy chart to determine the correct size Post Guard for your posts! Save yourself time by measuring before you place your order!

DIAMETER MEASURES	POST GUARD NEEDED
4½" or Less	4½" Post Guard
Greater than 4½" less than or equal to 7"	7" Post Guard
Greater than 7" less than or equal to 8⅞"	8.875" Post Guard
Greater than 8.875" less than or equal to 11½"	11½" Post Guard



HAVE CIRCUMFERENCE SIZE READY WHEN PLACING YOUR ORDER

For expanded sizing charts and more information on how to measure for your bollard covers, please visit kleen-ritecorp.com!

PLEASE NOTE: POST GUARD® PRODUCTS ARE NON-RETURNABLE

VACUUMS & ACCESSORIES

BOLLARD COVERS & PARKING BLOCKS

New!



AMERICAN FLAG BOLLARDSOX POST GUARD



- A sleeve for bollards with a Patriotic American Flag print. Its slip-over design makes installation a breeze. Give your bollards a new look for holidays
- It is recommended to leave 2" off the ground
- Perfect for Flag Day, Independence Day, Memorial Day, and Veterans Day

\$42.67	PGSOX-452A	4" x 52"
\$42.67	PGSOX-752A	7" x 52"



BOLLARD COVER SIGN AHEARN SIGNS



- 3-Sided, Up to 13" W x 48" H
- UV, heavy-duty 4 mil coroplast composition
- **CUSTOMIZATION OPTIONS:**
 - Customer sends logo and wording
 - Ahearn creates artwork for approval

CALL	BOC04	Custom
	BOC04-FTO	Please Return Towels
	BOC04-GUN	Bug Scrub
	BOC04-GAP	Customer Appreciation



UV RESISTANT ULTRA PARKING BLOCK - FOR ASPHALT USE

IDEAL SHIELD



- 6' long
- 100% recycled plastic
- Weather, chemical, and UV resistant
- Patented recessed bolt holes
- Easy and fast installation (hardware spikes included)
- Lightweight for reduced shipping costs and easy transport
- Install on asphalt
- Made in the U.S.A.
- Manufacturer lifetime warranty

\$102.24	PC100Y-A	Yellow	Install on Asphalt
\$102.24	PC100G-A	Gray	Install on Asphalt
\$102.24	PC100BL-A	Blue	Install on Asphalt



UV RESISTANT ULTRA PARKING BLOCK - FOR CONCRETE USE

IDEAL SHIELD



- 6' long
- 100% recycled plastic
- Weather, chemical, and UV resistant
- Patented recessed bolt holes
- Easy and fast installation (hardware spikes included)
- Lightweight for reduced shipping costs and easy transport
- Install on concrete
- Made in the U.S.A.
- Manufacturer lifetime warranty

\$102.24	PC100Y-C	Yellow	Install on Concrete
\$102.24	PC100G-C	Gray	Install on Concrete
\$102.24	PC100BL-C	Blue	Install on Concrete



SPEED BUMPS

POST GUARD



- Helps make parking lots safer by reducing vehicle speeds to 2-5 mph
- Channeled bottom facilitates drainage and can cover cabling or piping
- Flexible design conforms to the contour of virtually any road surface
- Smooth riding traffic control products
- Simple to install and made from 100% recycled tires!

\$180.00	PG24111	Speed Bump 4' L x 12" W x 2¼" H
\$232.50	PG26111	Speed Bump 6' L x 12" W x 2¼" H
\$38.75	PG26999	End Cap, Speed Bump 6" long x 12" W x 2¼" H

PLEASE NOTE: POST GUARD® PRODUCTS ARE NON-RETURNABLE

LED LIGHTING AND RETROFIT KITS

JDS DIAMOND SERIES LED LIGHTS

JARVIS



- An LED canopy light perfect for gas stations and other canopy applications. With a drop lens design, this fixture has a very high illumination to significantly enhance any location.

DETAILS:

- Drop lens design increase site visibility from roadway
- UV Stabilized PC Lens increase longevity
- Catch wire to hold fixture in place during installation
- Lens is impact resistant
- Fixture designed with rear facing heat sinks to not trap visible dirt
- Designed for quick and easy installation

\$201.39	LED330-100	100 Watt - 12,677 Lumens
-----------------	-------------------	--------------------------

XBEAM LED CROSSBEAM™ CANOPY LIGHTS

JARVIS



- For gas station canopies
- Use in wet or dry locations
- Operating voltage: 120-277 V
- Operating temperature range: -40° to 113° F
- Four LEDs send out crossing beams of light to create focused yet even illumination
- Internal reflector and high clarity prismatic borosilicate glass lens
- White coated body resists UV degradation

\$243.06	LED360-105	105 Watt - 13,110 Lumens
\$262.50	LED360-147	147 Watt - 17,420 Lumens
\$276.39	LED360-150	150 Watt - 20,020 Lumens

SCRT-320 LED RETROFIT KIT FOR LSI SCOTTSDALE FIXTURES

JARVIS



- Allows you to change from traditional bulbs to LED technology on your LSI Industries Scottsdale lighting fixtures. Kit features simple installation combined with the best lighting technology; making it the ideal choice when updating LSI Industries Scottsdale fixtures.

SPECIFICATIONS:

- 4 heavy duty, high-efficiency LEDs
- 120-277V, 50/60 Hz input
- 107W power
- 14,680 lumens

DETAILS:

- For use with Scottsdale LSI light fixtures
- Very easy installation
- 72% reduction in electricity versus standard lights
- DesignLights Consortium® premium qualified product – Rebate eligible in most areas
- ETL Listed for wet locations
- Smart power supplies adjusts to any voltage within a range of 120-277 volts

\$237.92	LED300
-----------------	---------------

CPY250 SERIES LED CEILING MOUNT LIGHTS

CREE LED LIGHTING



- The CPY250 delivers 13,000 lumens (30% brighter than a 400W metal halide) of beautiful, high-quality light with superior efficiency. With rugged cast aluminum construction and an integral heat sink, the CPY250 can withstand the most challenging outdoor environments. Available with a flat (CPY250-FL) or 1" prismatic drop lens (CPY250-DL), the luminaire provides two aesthetics to meet visual and illumination performance needs. The slim, low profile design enhances curb appeal, while offering seamless installation.
- Class I, Division II Hazardous Location for select models
- Slim low profile design
- Universal 120-277V
- DLC and UL Listed
- CCT: 5700K
- IP66 Rated
- Made in the USA
- Direct mount
- 13000 lumens
- Exclusive DeltaGuard® Finish
- 10 year warranty
- Flat or drop lens option
- 100 lumens / watt

\$371.35	LED910-DL	Drop Lens	96 Watts
\$376.77	LED910-FL	FLAT Lens	120 Watts





RETROFIT KITS, LED LIGHTING AND CANOPY FIXTURES

SCOTTSDALE VERTEX™ CANOPY FIXTURE

LSI LIGHTS

- This SCV canopy light fixture is capable of being retrofitted to a variety of older arrangements, and is also built to accommodate future additions of wireless controls, sensors, and other hardware. Possibly the best feature of the Scottsdale Vertex fixture is the Symmetric Combination Forward Throw optics that produce light over a larger area and eliminates or reduces the need for flood lights

FEATURES:

- Wireless controls
- Best in class energy efficiency
- Innovative retrofit options to replace out-dated fixtures
- Hybrid distributions offer safer extended light path

ELECTRICAL DETAILS:

- High-performance driver features over-voltage, under-voltage, short-circuit and over temperature protection
- Voltage - 120-277VAC
- L80 Calculated Life: over 100k hours
- Driver dims to 10%
- Total Harmonic Distortion: under 20%
- Operating Temp: -40 °F to 122 °F
- Power Factor: >0.90
- Driver complies with FCC standards
- High-efficacy LEDs mounted to 4 circuit boards for maximum heat dissipation

OPTICAL DETAILS:

- Standard symmetric distribution
- Minimum 80 CRI
- 5000K color temperature



\$306.40	LIGX1212-13*	90 Watt - 13,000 Lumen	\$287.17	LIGX1612-13	90 Watt - 13,000 Lumen No Surface Mount Kit Included
\$374.35	LIGX1212-15*	102 Watt - 15,000 Lumen	\$323.07	LIGX1612-15	102 Watt - 15,000 Lumen No Surface Mount Kit Included
\$433.32	LIGX1212-20*	133 Watt - 20,000 Lumen	\$382.04	LIGX1612-20	133 Watt - 20,000 Lumen No Surface Mount Kit Included
*673433 SURFACE MOUNT KIT INCLUDED					

SCOTTSDALE SCM WHITE LED CANOPY FIXTURE

LSI LIGHTS

CERTIFICATIONS AND LISTINGS:

- Listed to UL 1598 and UL 8750
- Meets Buy American Act requirements
- IP66 Rated Luminaire
- State of California Title 24 Compliant with IMSBT option

SPECS & GENERAL INFO:

- Rugged low-profile die-cast aluminum housing
- Installs in a 12" or 16" deck pan
- Below canopy access to optical chamber and driver housing for serviceability

ELECTRICAL:

- 5000K color temp
- 0-10 volt dimming (10% - 100%)
- Standard Universal Voltage: 120-277VAC
- Operating Temperature: -40 °F to 122 °F

- Low profile 2" luminaire height and lightweight design
- Suitable for wet locations
- L80 Calculated Life: over 100k hours
- Fixtures are finished with a polyester powder coating

\$240.26	LIGX1215-13	13,000 Lumens - 86 Watts	\$287.80	LIGX1215-20	20,000 Lumens - 147 Watts
\$253.68	LIGX1215-15	15,000 Lumens - 111 Watts	\$175.00	LIGX1220	Aluminum Light Fixture Box



MIRADA LED WALL SCNCE

LSI LIGHTS

- Die-cast aluminum housing
- High performance silicone optics
- 8,600 + lumens
- 5 year warranty
- Operating Temperature: -40 °C to +50 °C (-40 °F to +122 °F)
- SMARTTEC™: Integral sensor reduces drive current, when ambient temperatures exceed rated temperature
- Drivers are dimming, standard. Components are fully encased in potting material for IP65 moisture resistance. Driver complies with IEC and FCC standards. Driver can be easily accessed.
- Industry-leading photometry through LSI's exclusive new molded silicone optical system

\$526.86	LIGX5505-BLK	Black	
\$526.86	LIGX5505-BRZ	Bronze	

WPSLS SERIES SMALL LED WALL PACK 2000 LUMENS - 20 WATTS

LSI LIGHTS

- **LEDs:** Color temperature 5000K, 2000 lumen package, 2418 delivered lumens, minimum CRI of 71, zero uplight
- **CONSTRUCTION:** Rigid precision die cast-aluminum housing for durability and consistency.
- **THERMAL MANAGEMENT:** Stacking heat removal technology extracts heat from within the housing and moves it away from LEDs
- **INSTALLATION:** Surface mounts direct to J-box or wall. Features a bubble level and removable hinged face frame.
- **DIMMING:** 0-10 volt dimming standard.
- **OPERATING TEMPERATURE:** -35 ° to 40 °C (-31 ° to 104 °F)
- **ELECTRICAL:** 120-277v, 50/60 Hz) input.
- **EXPECTED LIFE:** Minimum 100,000 hours.

\$151.23	LIGX1012
-----------------	-----------------



WALL MOUNT LED LIGHTING



PERIMALITER® III PVL3 LED WALLPACKS

HUBBELL LIGHTS



- 12" W x 9.3" D x 4.8" H
- CCT: 5700K
- Universal 120-277V
- Made in the U.S.A., some imported parts
- 42W, 4109 lumens
- Up to 100 lumens/watt
- 10 Year Warranty
- 70+ CRI
- Type III distribution
- DLC and UL Listed
- Exclusive Colorfast DeltaGuard® Finish
- IP66 Sealed
- 100,000 hour LED Life

\$648.96

LIGL200G

Glass Lens



TWX3-LED-ALO-50K-MVOLT-DBBTXD LED WALLPACK

Lithonia

- The TWX3 series of wall luminaires is an energy-efficient, low maintenance LED wall pack for replacing up to a 400W MH fixture. The unit is built for car wash use, with two-piece die-cast aluminum housing that is completely sealed against moisture and environmental contaminants (IP65) and is suitable for applications where water is a concern. With an expected service life of more than 20 years, it eliminates frequent lamp and ballast replacements. Adjustable Light Output (ALO) allows for adjustable light output at installation to meet site needs.
- Lumens: 2,900 - 13,850 lumens, set at installation
- Color Temperature: 5000K
- Finish: Textured Dark Bronze
- Voltage: 120-277V
- System Watts: 108W

\$388.11

LIGL210

Wall Pack

LED SURFACE MOUNT

CREE LED LIGHTING

CREE LED LIGHTING



- 12" W x 9.3" D x 4.8" H
- 70+ CRI
- IP66 Sealed
- CCT: 5700K
- Made in the U.S.A., some imported parts
- 100,000 hour LED Life
- Universal 120-277V
- DLC and UL Listed
- Up to 100 lumens/watt
- 42W, 4270 lumens
- 10 Year Warranty
- Type III distribution
- Exclusive Colorfast DeltaGuard® Finish

\$279.38

LED915



AL SERIES FLEXPACK LED WALL PACK LUMINAIRE

JARVIS



- The Jarvis wall pack LED light offers two different positions for installation. Users may choose to orient the lens parallel to the horizon for "dark sky" mounting that directs all light downward, or mount at a 45° angle for forward-throw illumination across parking lots and more. The chosen position will become fixed during installation; wall pack removal would be required to readjust the lens.
- Durable, UV-resistant body
- Bronze color and also available in white
- 120-277V electrical connection required for operation
- 0-10 volt dimmable LEDs
- Operating temp. range: -40° to 104° F
- Features automatic temperature protection

\$165.28

LED350-29B

29 Watt • 3,182 Lumens

\$187.50

LED350-56B

56 Watt • 6,354 Lumens

\$215.28

LED350-83B

83 Watt • 10,630 Lumens

\$229.17

LED350-104B

104 Watt • 13,350 Lumens

\$16.53

LED0299

120-277V Button Photocell

WALL MOUNT LED LIGHTING



Available in bronze or white

WMFT SERIES LED WALL PACK LUMINAIRE

JARVIS

- The Jarvis WMFT Series LED wall pack luminaire is outfitted with two LEDs and reflectors that direct light down and out. This design makes the WMFT wall pack ideal for illuminating large spaces like parking lots because it features a base that is identical to most HID wall packs. Upgrading to LED is easy! Automatic temperature protection reduces power level in high temperatures to protect internal components from the heat. Compatible with most motion sensors and photo sensors (mount into knockouts on side of housing or baseplate).
- Die-cast, coated body withstands sun and elements • Two LEDs per pack • Easy to put in place of existing HID
- Forward throw prismatic lens design • Standard 0-10 volt dimming • Operating temperature: -40° to 104° F

\$138.89	LED380-25B	25 Watt	\$193.06	LED380-103B	103 Watt
	LED380-25W	3,200 Lumens		LED380-103W	12,760 Lumens
\$165.28	LED380-52B	52 Watt	\$16.53	LED0299	120-277V
	LED380-52W	6,451 Lumens			Button Photocell
\$173.61	LED380-77B	77 Watt	\$12.59	LEDP0300	120V Button
	LED380-77W	9,503 Lumens			Photocell Sensor
			\$165.28	LED352-52B	Wall Pack

LUMOS SERIES FLEXPACK LED WALL PACK LUMINAIRE

JARVIS

- The Jarvis LUMOS Series is the latest wall pack to feature Jarvis' patented FlexPack™ technology. The LUMOS series 2-position mounting plate allows a site to have uniform fixture appearance while solving multiple light throw requirements. This fixture pairs a long-lasting and robust construction with a bright uniform light output.
- Converts between a forward throw and a dark sky wall pack • Standard 0-10V dimming
- Housing designed with space for factory installed motion sensor • Voltage: 120-277V
- UV-resistant powdercoat finish avoids fading and flaking • Operating temperature: -31° to 104° F

\$118.06	LED390-35	35 Watt - 4,305 Lumens
\$131.94	LED390-48	48 Watt - 5,952 Lumens
\$180.56	LED390-78	78 Watt - 9,672 Lumens
\$194.44	LED390-96	96 Watt - 11,808 Lumens
\$16.53	LED0299	120-277V Button Photocell



JMP SERIES SMALL LED WALL PACK LUMINAIRE

JARVIS

- Jarvis Lighting's JMP Series small LED wall pack is the perfect solution for lighting entrances, doorways, and other wall-mounted applications which require quality and reliability. Featuring a built in photocell, the fixture will automatically provide the proper illumination from dusk to dawn
- Selectable Wattage and selectable CCT • Standard 0-10V dimming
- Durable die cast aluminum housing • Voltage: 120-277V
- UV-resistant powder coat finish avoids fading and flaking • Operating temperature: -40° to 113° F

\$62.50	LED337	15W/20W/25W, 2,025/2,800/3,500 Lumens
----------------	---------------	---------------------------------------



ARJ SERIES LED AREA LUMINAIRE

JARVIS

- ARJ Series LED bronze area light, lights up parking lots and other large areas. The light fixture is compatible with the slipfitter, square, or round pole direct mounts
- Reliably clear type III optics
- LEDs with 0-10 volt dimming
- 120-277V electrical connection required
- Operates between -35° and 104° F ambient temperatures
- UV-resistant powder coat finish avoids fading and flaking

\$333.33	LED340-150B	Slipfitter Mount	150W - 21,750	\$506.94	LED340-200BF	Slipfitter Mount	200W - 29,000
\$333.33	LED340-150BF	Fixed Mount	Lumen Models	\$506.94	LED340-200B	Fixed Mount	Lumen Models



LED340-150B



POLE MOUNT AREA LIGHTING

COMMERCIAL AREA SMALL FIXTURE POLE LIGHT

LSI LIGHTS



CONSTRUCTION:

- Rugged die-cast aluminum housing for maximum durability and reliability
- IP65 rated luminaire protects integral components from harsh environments
- Shipping weight: 17.24 lbs. in carton

OPTICAL SYSTEM:

- Premium engineered IP65 rated acrylic optic assemblies deliver. Type 3, 4 (FT) or 5 distributions
- Zero uplight
- Available in 5000K, 4000K, and 3000K color temperatures per ANSI C78.377
- Minimum CRI of 80

ELECTRICAL:

- Features short-circuit and over temperature protection with integral surge protection (6kV)
- 0-10V dimming (10% - 100%) standard
- Standard Universal Voltage (120-277 Vac)
- Input 50/60 Hz or optional High Voltage (347-480 Vac)
- L70 Calculated Life: >50K Hours
- Total harmonic distortion: <20%
- Temperature: -40°C to +40°C (-40°F to +104°F)
- Power factor: >.90
- Input power stays constant over life
- Optional 10kV surge protection device meets a minimum Category C Low operation (per ANSI/IEEE C62.41.2)
- High-efficacy LEDs mounted to metal-core circuit board to maximize heat dissipation

PRICE	PART #	DESCRIPTION
\$278.07	LIGX3015-12	12,000 Lumens, 105 W
\$376.86	LIGX3015-18	18,000 Lumens, 151 W
\$417.10	LIGX3015-21	24,000 Lumens, 175 W

COMMERCIAL AREA MEDIUM FIXTURE POLE LIGHT

LSI LIGHTS



SPECIFICATIONS:

- Universal voltage - 120-277 V
- Acrylic lens
- 5,000K CCT
- Square pole mounted
- 80 CRI minimum color rendering
- 0-10 dimming driver (0-10%)
- Temperature range from -40°F to 104°F

CONSTRUCTION FEATURES:

- Rugged die-cast aluminum housing for maximum durability and reliability
- IP65 rated luminaire protects integral components from harsh environments

OPTICAL SYSTEM FEATURES:

- IP65 rated acrylic optic assemblies deliver
- Type 3, 4 (FT) or 5 distributions
- Zero uplight
- Minimum CRI of 80

ELECTRICAL FEATURES:

- Has shortcircuit and over temperature protection with integral surge protection (6kV)
- L70 Calculated Life: >50K Hours
- Total harmonic distortion: <20%
- Power factor: >.95
- Input power stays constant over life
- Optional 10kV surge protection device meets a minimum Category C Low operation (per ANSI/IEEE C62.41.2)
- High-efficacy LEDs mounted to metal-core circuit board to maximize heat dissipation

PRICE	PART #	DESCRIPTION
\$517.11	LIGX3018-28	28,000 Lumens, 229 W

BRONZE 40 W FLOOD LIGHT

LSI LIGHTS



- Precision die-cast aluminum housing with stainless steel hardware, tempered borosilicate glass lens
- SFLM, WF Distribution, LED, PL1, 50 - 5000K Color Temperature, UE Input Voltage, Photocell Dimming Controls
- 120-277 photocell standard with cover
- System Wattage: 40W
- 4733 Lumens
- Minimum 50,000 hours
- Replaces 150W HID
- Limited 5-year warranty

\$181.72	LIGX1165
-----------------	-----------------

POLE MOUNT AREA LIGHTING



LSI SLICE BRONZE MEDIUM OUTDOOR LED AREA LIGHT

LSI LIGHTS



- A sleek, original design for outdoor commercial property lighting. Made with aluminum and has a bronze-color finish, a single-piece silicone optic sheet, and a slim design.
- Industry-leading photometry through LSI's exclusive new molded silicone optical system
- Contemporary, sleek, low-profile styling. 3 piece die-cast aluminum housing
- High performance driver features over-voltage, under-voltage, short-circuit and over-temperature protection
- 120V-277V • UL Listed • Bronze Finish

PRICE	PART #	DESCRIPTION	PRICE	PART #	DESCRIPTION
\$592.73	LIGX3010-18	18,000 Lumens, 150 W	\$509.79	LIGX3142	10' Pole w/ 4" Square Base cover
\$720.78	LIGX3010-24	24,000 Lumens, 187 W	\$623.22	LIGX3140	16' Pole w/ 4" Square Base cover
\$583.33	LIGX3010-30	30,000 Lumens, 247 W			



JSAL-G2 SERIES SLIM LED AREA LUMINAIRE

JARVIS



- Jarvis Lighting's JSAL Series Slim LED Area Light offers a high quality solution for parking lot and area lighting applications. This features a variety of quick-mount arms that allow for fast and easy installation no matter where they are mounted.
- Standard 0-10V dimming
- Operating temperature: -40° to 104° F
- Voltage: 100-277V
- UV-resistant powder coat finish avoids fading and flaking
- Operating temperature: -40° to 104° F
- Available in bronze color and white

\$187.50	LED365-100BF	Fixed Mount	100 Watt 14,000 Lumens
\$187.50	LED365-100B	Slipfitter Mount	
\$215.28	LED365-150BF	Fixed Mount	150 Watt 21,000 Lumens
\$215.28	LED365-150B	Slipfitter Mount	

\$284.72	LED365-200BF	Fixed Mount	200 Watt 28,000 Lumens
\$284.72	LED365-200B	Slipfitter Mount	
\$312.50	LED365-240BF	Fixed Mount	240 Watt 33,600 Lumens
\$312.50	LED365-240B	Slipfitter Mount	

\$361.11	LED365-300BF	Fixed Mount	300 Watt 42,000 Lumens
\$361.11	LED365-300B	Slipfitter Mount	



FLD-G2 SERIES LED FLOOD LIGHT LUMINAIRE

JARVIS



- FLD-G2 Series is a slim, highly-efficient LED flood light. Thus flood light features high-quality LEDs that will last a long time. FLD-G2 comes in 3 different mounting options.
- Dedicated flood optics • 120-277V • Operating temperature: -40° to 113° F
- Durable die-cast aluminum housing • Adjustable mounting arms for perfect mounting angle
- 0-10V dimming standard on 15W-90W models and 1-10V dimming standard on 150W models

\$34.72	LED370-15	15 Watt 1,833 Lumens
\$47.22	LED370-30	30 Watt 3,725 Lumens
\$62.50	LED370-50	50 Watt 6,539 Lumens

\$131.94	LED370-70	70 Watt 9,175 Lumens
\$145.83	LED370-90	90 Watt 11,984 Lumens
\$201.39	LED370-150	150 Watt 20,000 Lumens

LED LIGHTING



LED CEILING MOUNT LIGHTS

LSI LIGHTS



- Provides excellent lighting in heavy-duty, high-impact, reinforced fiberglass housing. With its vaportight design, it is ideal for utility, backroom, and cooler applications. Offered with high-impact acrylic lens and symmetrical distribution for outstanding light delivery.
- **OPTICAL SYSTEM:** Use of closely-spaced medium-power, high-brightness chips minimizes pixilation and provides uniform lens luminance. Frosted, injection-molded, high-impact acrylic is standard.

- **ELECTRICAL:** Projected life of at least 200,000 hours. Standard Universal voltage (120-277 Vac) input, 50/60Hz Power factor > 0.9, THD < 20%, in-rush current < 15 Amps or optional High Voltage (347-480 VAC). Operating Temperature: -40° F to 104° F.
- **CONSTRUCTION:** Inner gear tray is constructed of code gauge steel. Outer housing is constructed of fiberglass reinforced polyester. Gasketing in the housing is constructed of closed cell polyurethane. Conduit entrance is provided at both ends. Finish coating of housing reflecting surfaces is with high-reflectance (minimum 92%) polyester powder. High pressure hose down (1500PSI). IP65 Certified / IP66 Certified / IP67 Certified (comparable to NEMA 6). NEMA 4X rated.



\$249.11	LIGX6000	4 foot, 60W, 4,511 Lumens
\$453.56	LIGX6050	8 foot, 120W, 14,290 Lumens



ZR24 SERIES LED TROFFER

CREE LED LIGHTING

CREE | LED LIGHTING

- Powered by Cree TrueWhite® Technology, the slim and lightweight ZR24™ LED troffer boasts a 125 LPW performance along with 0-10V dimming to meet local energy codes
- Embodies a breakthrough in balancing energy savings, visual comfort and initial cost.
- CREE TrueWhite® Technology: 4040 lumens of superior 80+ CRI light quality
- Provided t-bar clips and holes for mounting support
- Rolled steel housing
- Ultra-thin 3.9" fixture height
- Designed for indoor use
- Suitable for damp locations
- Input Voltage: 120-277V, 50/60Hz

\$198.99 **LEDZR24**



KBL SERIES HIGH-BAY DIMMABLE LUMINAIRE

CREE LED LIGHTING

CREE | LED LIGHTING

- 16" aluminum reflector
- 240 Watt; 27,500 Lumens
- 80 CRI
- Operating temperature: -40° and 104° F
- Universal mount
- 4000K
- 120-277V

\$549.50 **LED905**

G&G LED



CAR WASH LIGHTING



DESIGNED SPECIFICALLY WITH YOUR CAR WASH IN MIND.

Experienced car wash operators know bright bay lighting is important! When it comes to LED lighting for car washing, G&G knows exactly what it takes to survive this incredibly demanding environment. Engineered to withstand constant exposure to moisture, direct spray, car wash chemicals and debris, G&G's lights are guaranteed to last where others typically fail.

LET YOUR CAR WASH SHINE

High pressure spray, rigorous cleaning chemicals and constant high humidity levels are all factors that challenge car wash lighting. G&G's linear LED fixtures were designed specifically for the harsh environment of a car wash. The 1" round low-profile housing with quick-connect cabling is both waterproof and chemical resistant, allowing them to thrive in an environment where many other products fail. Our Direct AC driverless GPX fixtures are ideal for Self Serves where ease of installation and long life are key. This innovative technology removes the external driver from the system and allows you to power the first fixture directly from AC line voltage while connecting the others using push-and-click cables. Our WPX harsh environment lights are the most rugged, durable solutions that can handle anything the car wash presents them with.

From self-serve and in-bay automatic lighting, to tunnels and high-power color effect lighting, G&G has your lighting needs in wash facilities covered. All of G&G's LED luminaires are UL wet location rated and made in the USA, backed by an industry leading, no-questions-asked warranty.



FEATURED PRODUCT

EASY INSTALL

Converting your car wash to LED lights doesn't need to be a hassle. G&G's plug-and-play design is easy to install. You can use it in your bays, around awnings, near vacuums, and more!

G&G LED lights are easy to install with mounting clips. Drill holes, place mounting clips, and push in your luminaire! Each mounting clip will snap around the light and create a secure hold. G&G's WPX and GPX bay lights connect end-to-end, by waterproof cables, or a mix of the two. Jumper cables are a great choice when installing lights around other wall-mounted objects. Installation takes hours, not weeks! Check out Kleen-Rite's YouTube page for a step-by-step video.



G&G'S PRO TIPS FOR INSTALLATION

- Turn off any electrical current running to your installation area.
- Mount fixtures on ceiling wherever possible; 2-3 feet from walls.
- If ceiling mount is not feasible, mount directly to walls.
- Mark a chalk line to keep lights even during installation!
- To install an 8' light, place two mounting clips 7 feet apart, and one in the middle.
- To install a 4' light, place two mounting clips 40 inches apart.
- Mark your holes, drill, and push clips into the ceiling or wall.
- Press each luminaire into the clips and watch them snap in place!
- Remove end caps from lights and push luminaire ends together to connect.
- Move around obstructions with waterproof jumper cables. Just push to connect!
- Connect the lead wires on one of the end lights into a compatible power source.
- Be sure to leave ceiling caps on the exposed end of the first and last light in the row.
- Turn on the power and enjoy bright light day or night!

CHOOSING THE RIGHT LIGHT

GPX DRIVERLESS LINEAR LIGHTING



GPX Driverless Linear Lighting has a maintenance-free design. It connects to AC line voltage and is easy to daisy-chain. Coextruded copolyester and aluminum single-piece housing provides great heatsinking ability. Recommended for self-serve bays or outdoor lighting and is bendable for vacuum arch lighting. Ideal where high humidity is an issue. Can be daisy chained with jumper cables or connected end to end for long linear runs of light.

- **EFFICACY** 130 LPW
- **CRI** 85
- **LIFETIME** 100,000 hours at 77 ° F
- **LOCATION** Wet environment ceiling or wall mount
- **ELECTRICAL INPUT**..... 120 or 277 VAC
- **OPERATING TEMP** -40 ° C and 55 ° C
- **DELIVERED LIGHT OUTPUT**... Up to 1,000 lumens per foot
- Connect end to end or via jumper cable
- Maintenance-free design
- IP67 rated
- UL wet listed

WPX HARSH ENVIRONMENT LINEAR LUMINAIRE



WPX Harsh Environment Linear Luminaire lights are easy to install and connect! It features a seamless polymeric outershell with an IP68/IP69K rating and has great chemical resistance. Plus, an embedded aluminum heatsink provides great cooling for a long life. Great for IBAs and tunnels where direct spray and chemical exposure is an issue. Connects using jumper cables for long linear runs of light.

- **EFFICACY** Up to 140 LPW
- **CRI** 85
- **LIFETIME** 100,000 hours at 77 ° F
- **LOCATION** Wet environment ceiling or wall mount
- **OPERATING TEMP** -40 ° C and 55 ° C
- **DELIVERED LIGHT OUTPUT**... Up to 12,000 lumens
- Connect up to 72 feet of luminaires
- IP68/69K rated
- IK07 impact rated
- NSF certified
- UL wet listed
- DLC rated

FEATURED PRODUCT

SELF SERVE BAY LIGHTING KITS

G&G
INDUSTRIAL LIGHTING



LED LIGHTING KITS

G&G LED Lighting is excited to release a new driverless, direct AC LED fixture designed specifically for the car wash industry.

This new cost effective series is ideal for lighting self-serve wash bays, vacuum areas, awnings, canopies and maintenance rooms. Find two of their popular self-serve bay lighting kits below!

- ☑ IP67 - Wet Location Rated
- ☑ 120 Lumens Per Watt
- ☑ Direct AC/Driverless - 120V Input Only
- ☑ Easy Install - Plug & Play, Low-Profile
- ☑ 5-Year Warranty
- ☑ Made in USA



STANDARD SELF-SERVE PACKAGE (4 LIGHTS)



GGBAY48SS-AC

Includes	(4) 8' LED Fixtures (2) 4' Jumpers	200W • 24,000 Lumens	\$1,208.00
----------	---------------------------------------	----------------------	-------------------

LARGE SELF-SERVE PACKAGE (6 LIGHTS)

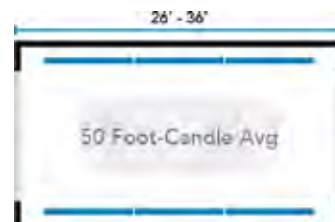

GGBAY68SS-AC

Includes	(6) 8' LED Fixtures (4) 1' Jumpers	300W • 36,000 Lumens	\$1,804.00
----------	---------------------------------------	----------------------	-------------------

LIGHTS



PREMIUM BAY & TUNNEL LIGHTING KITS



LED LIGHTING KITS

G&G LED Lighting continues to improve upon their popular IP68/IP69K linear LED lighting widely utilized in the car wash industry. The newest generation of their High-Output series is now achieving over 12,000 lumens and up to 150 lumens per watt! The premium solution for your In-Bay Automatic and Tunnel Lighting needs.



- ☑ IP68/IP69K - High Pressure Hose-Down Rated
- ☑ 150 Lumens Per Watt
- ☑ External Driver - 120V-277V Input
- ☑ Easy Install - Plug & Play, Low-Profile
- ☑ 5-Year Warranty
- ☑ Made in USA

IN-BAY AUTOMATIC PACKAGE

(4 HIGH-OUTPUT LIGHTS)

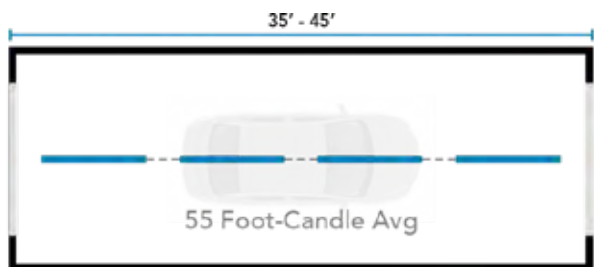

GGBAY48IB			
Includes	(4) 8' High Output LED Fixtures (3) 1' Jumpers	350W • 50,000 Lumens	\$1,956.00

TUNNEL PACKAGE

(12 HIGH-OUTPUT LIGHTS)



GGBAY128TNL			
Includes	(12) 8' High Output LED Fixtures (10) 8' Jumpers	750W • 100,000 Lumens	\$5,982.00



PREMIUM COLOR ARCH LIGHTING KITS

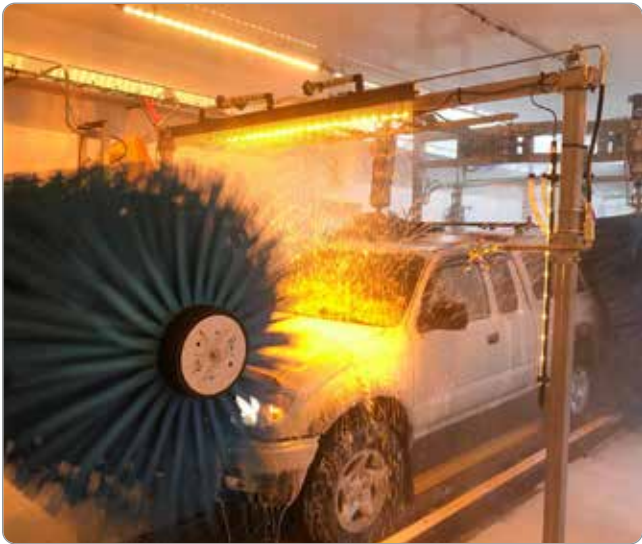

- ✓ High intensity Spot Optics
- ✓ UL Wet Listed, IP68 rated & chemical resistant
- ✓ Easy Install - Plug & Play, Low-Profile
- ✓ Made in USA
- ✓ 3-Year Warranty
- ✓ Industry Leading Brightness

TOP ONLY ARCH LIGHTING KIT (1 LIGHT)

- (1) 6' LED Fixture
- (1) 25' Leader Cable & Power Supply

\$773.62	GG6006A	Amber	
\$773.62	GG6006B	Blue	
\$773.62	GG6006G	Green	
\$773.62	GG6006R	Red	

IMMERSIVE ARCH LIGHTING KIT (3 LIGHT)

- (1) 6' LED Top Fixture
- (2) 4' LED Side Fixture
- (1) 25' Leader Cable & Power Supply
- (2) 4' Jumper cables

\$1,500.97	GG6014A	Amber	
\$1,500.97	GG6014B	Blue	
\$1,500.97	GG6014G	Green	
\$1,500.97	GG6014R	Red	

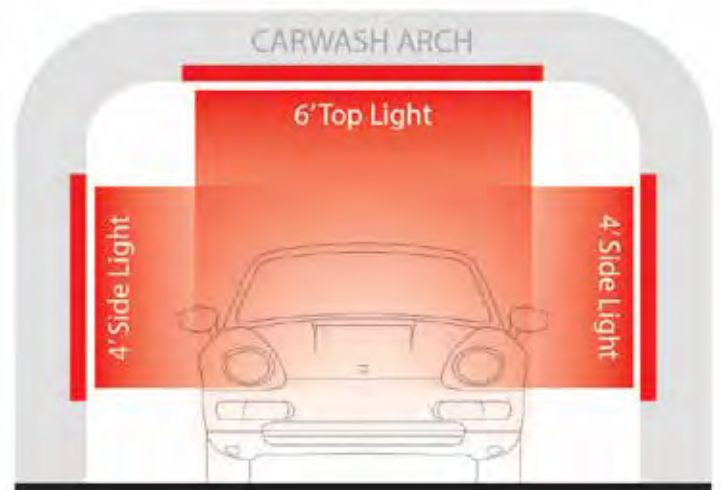
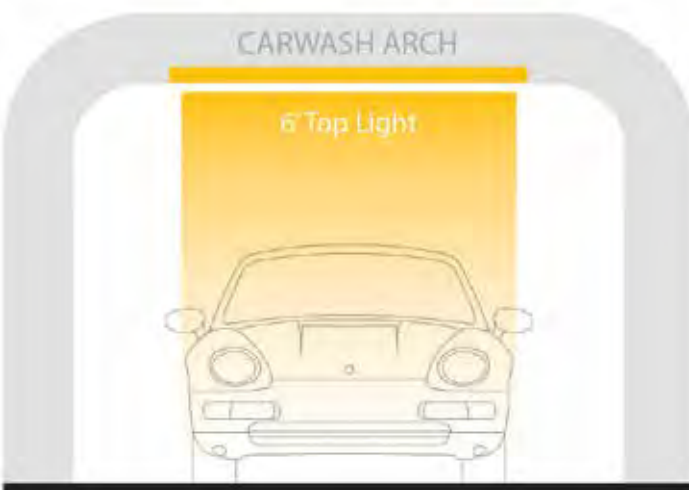

LIGHTS



LED LIGHT STRIPS

SELF-SERVE BAYS



New!

SELF-SERVE BAY LED LIGHT PACKAGE

CAR WASH LIGHTS

Driverless Bright Bay Package

(28,800 lumens)
2 x 24 ft. lights per bay,
no external driver needed

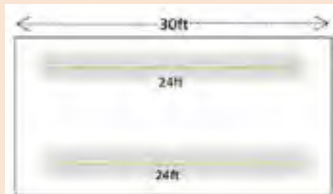

Super Bright Bay Package

(52,800 lumens)
2 x 24 ft. lights per bay,
required external driver

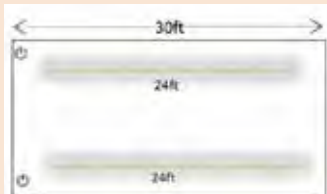

Color Changing Entrance/Exit Addition: Package

2 x 14 ft. color changing lights that turn off when car wash starts/flashes colors when idle

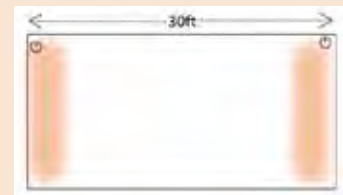

\$1,030.00	LEDLINE-S1	Driverless Bay Package
\$1,512.00	LEDLINE-S2	Super Bright Bay Package
\$3,019.00	LEDLINE-S3	Color Changing Entrance / Exit Package

IN-BAY AUTOMATICS



New!

IN-BAY AUTOMATIC LED LIGHT PACKAGE

CAR WASH LIGHTS

Top Mount Color Changing Addition

1 x 8 ft. color changing light creates 7 colors based on car wash functions



Super Bright Bay Package

(52,800 lumens)
2 x 24 ft. lights per bay

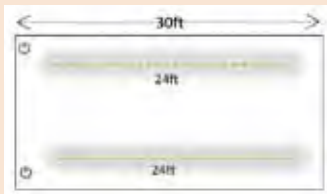

Fully Immersive/Integrated Color Changing Addition:

2 x 24 ft. color changing light for overhead, plus 1 x 8 ft. for equipment arm mount. Comes with SMARTBOX control that integrates with car wash function to create 250+ colors & variable light shows.



\$1,300.00	LEDLINE-A1	Top Mount Color Changing Package
\$1,512.00	LEDLINE-A2	Super Bright Bay Package
\$6,176.00	LEDLINE-A3	Fully Immersive Color Changing Package

VACUUM ARCHES



New!

Driverless White: Direct wires to 120V AC

Super Bright External: Driver (1100 lu. per ft.)

VACUUM LED LIGHTS

CAR WASH LIGHTS

DRIVERLESS			DRIVER		
\$175.00	LEDLINE-6-D	6 ft. - 3,600 lumens	\$343.20	LEDLINE-6	6 ft. - 6,600 lumens
\$250.00	LEDLINE-8-D	8 ft. - 4,800 lumens	\$304.00	LEDLINE-8	8 ft. - 8,800 lumens
\$300.00	LEDLINE-10-D	10 ft. - 6,000 lumens	\$370.00	LEDLINE-10	10 ft. - 11,000 lumens
\$330.00	LEDLINE-12-D	12 ft. - 7,200 lumens	\$444.00	LEDLINE-12	12 ft. - 13,200 lumens
\$350.00	LEDLINE-14-D	14 ft. - 8,400 lumens	\$504.00	LEDLINE-14	14 ft. - 15,400 lumens

LED LIGHT STRIPS

TUNNELS



New!

TUNNEL LED LIGHT PACKAGE CAR WASH LIGHTS

\$3,024.00	LEDLINE-T1	49 - 60ft Long Tunnel Package
\$4,536.00	LEDLINE-T2	73 - 90ft Long Tunnel Package
\$6,048.00	LEDLINE-T3	97 - 110ft Long Tunnel Package
\$7,560.00	LEDLINE-T4	121 - 140ft Long Tunnel Package
\$9,072.00	LEDLINE-T5	147 - 170ft Long Tunnel Package

49'-60' Long Tunnel

(105,600 lumens)
4 x 24 ft. lights per bay,
2 rows of 48 ft. each

73'-90' Long Tunnel

(158,400 lumens)
6 x 24 ft. lights per bay,
2 rows of 72 ft. each

97'-110' Long Tunnel

(211,200 lumens)
8 x 24 ft. lights per bay,
2 rows of 96 ft. each

121'-140' Long Tunnel

(264,000 lumens)
10 x 24 ft. lights per bay,
2 rows of 120 ft. each

145'-170' Long Tunnel

(316,800 lumens)
12 x 24 ft. lights per bay,
2 rows of 144 ft. each

Extra Lengths...

Add 2 rows of 10 ft. to any package above for tunnel lengths in-between standard sizes:
2 x 10 ft. lights to add to 24 ft. lengths above.
Adds 22,000 lumens

New!

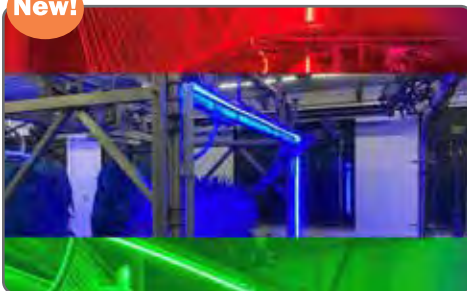

RGB ARCH TOP LIGHT CAR WASH LIGHTS

- A bendable LED strip ideal for installation on chemical arches in tunnel car washes. provides an incredible red, green, and blue color changing light show for customers, boosting more brightness per foot than any others in the industry.
- Colors: Red, Green, and Blue (color changing)
- UL Universal 120-277 voltage with external 24V DC driver
- 1100 lumen/foot - 8800 total lumen power
- 120 degree beam angle

\$520.00	LEDLINE-8-R	8ft Red
\$520.00	LEDLINE-8-G	8ft Green
\$520.00	LEDLINE-8-B	8ft Blue

\$520.00	LEDLINE-8-A	8ft Amber
\$520.00	LEDLINE-8-M	8ft Magenta
\$800.00	LEDLINE-8-RGB	8ft RGB

New!



FULL WRAP TUNNEL LIGHT CAR WASH LIGHTS

- The shape of your arch isn't an issue, as the light bends and wraps to fit perfectly. Dress up your tunnel with a high-quality LED system that is built to last!
- Colors: Red, Green, Blue, (color changing)
- UL Universal 120-277 voltage with external 24V DC driver
- 1100 lumen/foot - 26400 total lumen power
- 120 degree beam angle

\$1,320.00	LEDLINE-R	8ft Red
\$1,320.00	LEDLINE-G	8ft Green
\$1,320.00	LEDLINE-B	8ft Blue

\$1,320.00	LEDLINE-A	8ft Amber
\$1,320.00	LEDLINE-M	8ft Magenta
\$2,040.00	LEDLINE-RGB	8ft RGB

New!



LED NEON BUILDING WRAP CAR WASH LIGHTS

- Flexible LED strip ideal for car wash exteriors. Highlight signs, rooflines, walls, and more at a fraction of the price of classic neon!
- Sold by the foot
- Available with side bends, top bends or both
- Each run requires a \$50 setup fee, then the per foot cost is added to that

CALL	LEDNEON-R	Red, Per Foot
	LEDNEON-G	Green, Per Foot
	LEDNEON-B	Blue, Per Foot
	LEDNEON-A	Amber, Per Foot

CALL	LEDNEON-M	Magenta, Per Foot
	LEDNEON-RGB	RGB, Per Foot
	LEDNEON-CHASING	Chasing, Per Foot

LED LIGHT STRIPS

LED LIGHT STRIPS - DUAL COLOR - 29.8 WATT

BANNER LIGHTS

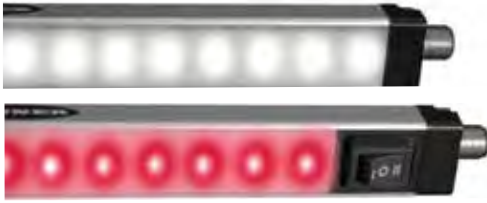

- Automatic temperature protection built into the unit. Above 50 °C, the light dims to manage heat and protect product lifetime
- Voltage: 12-30V DC; Environmental Rating: IP67/IP69K
- Colors: White (100%), Red (100%); Cascadable
- Length: 1130mm
- Linear strip housing style
- Dual color illumination
- Low-profile, space-saving design
- Daisy chain power to multiple lights
- Washdown rated, cascade
- Euro 4-pin quick-disconnect
- Aluminum housing material

CALL LED92734

LED LIGHT STRIPS - SINGLE COLOR - 29.8 WATT

BANNER LIGHTS



- Voltage: 12-30 V DC; Environmental Rating: IP67/IP69K
- 40% brighter and 40% more efficient than previous model
- Automatic temperature protection built into the unit. Above 50 °C, the light dims to manage heat and protect product lifetime
- Length: 1130 mm
- Hi/Lo/Off Switch
- Low-profile, space-saving design
- Daisy chain power to multiple lights
- Color: white; cascadable
- Euro 4-pin quick-disconnect
- Rugged, water-resistant IP69K option

CALL LED87897

LED LIGHT STRIPS

TSS CAR WASH SERVICES

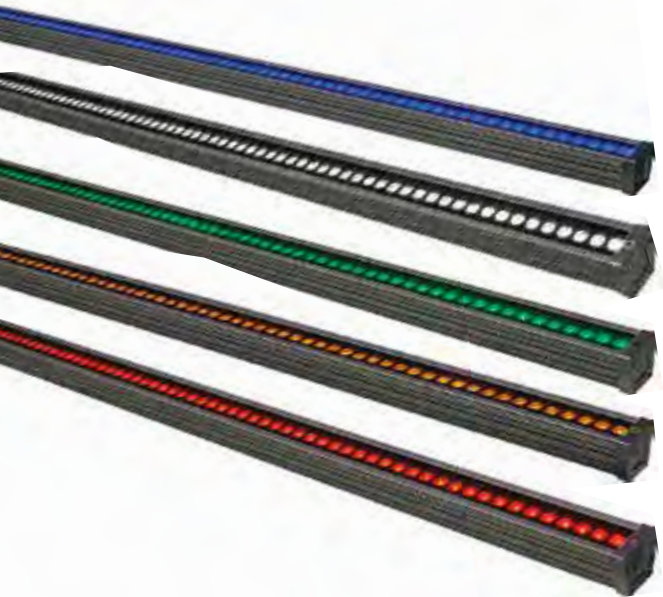

- These ultra bright LED strips can really put on a show by enhancing your extra services with a blast of color
- Provides vibrant color to any clear solution
- **SHOULD NOT BE EXPOSED TO DIRECT SPRAY**
- Back room power supply included
- Aluminum with tempered glass lens and silicon seal gasket
- Swivel Brackets - All mounting brackets must be attached to a non-vibrating arch
- 3 Swivel mount brackets included for easy mounting

6FT LED LIGHT STRIP - 144W, 24VDC

TSS CAR WASH SERVICES

\$962.18	TSS144B	Blue
\$962.18	TSS144R	Red
\$1,081.52	TSS144RGB	RGB Color Changing
\$86.28	TSS144SC	32' Extension Cord for 144 Watt Single Color LED w/ Male & Female Connections
\$52.77	TSSFL	24VDC Flasher - Pre-wired inside power supply box

7FT LED LIGHT STRIP - 210W, 24VDC

TSS CAR WASH SERVICES

\$1,185.96	TSS210B	Blue
\$1,185.96	TSS210R	Red
\$1,185.96	TSS210G	Green
\$1,185.96	TSS210Y	Yellow
\$1,426.19	TSS210RGB	RGB Color Changing
\$99.56	TSS210SC	40' Extension Cord for 210 Watt Single Color LED w/ Male & Female Connections
\$52.77	TSSFL	24VDC Flasher - Pre-wired inside power supply box

6FT LED LIGHT STRIP - 288W, 24VDC

TSS CAR WASH SERVICES

\$1,379.87	TSS288B*	Blue
\$1,455.48	TSS288R*	Red
\$1,484.30	TSS288RGB*	RGB Color Changing
\$99.33	TSS288SC	40' Extension Cord for 288 Watt Single Color LED w/ Male & Female Connections
\$52.77	TSSFL	24VDC Flasher - Pre-wired inside power supply box



* Dropship item

LEDs are extremely energy efficient and consume up to 90% less power than incandescent bulbs. Since LEDs use only a fraction of the energy of an incandescent light bulb, there is a dramatic decrease in power costs. Also, money and energy is saved in maintenance and replacement costs due to the long LED lifespan.

REPLACEMENT BULBS



POST TOP LED LIGHT

REPLACEMENT BULBS

- EX39 Mogul (39 mm diameter) base
- 5140-8870 lumens
- Input Voltage- 120-277VAC
- Output Power- 35, 45, or 60 Watt settings
- Life Expectancy- Up to 50,000 hours
- CRI- 80+
- Replaces- 175, 250, or 320 Watts
- Beam Angle- 360 Degrees
- Dimmable- No
- Color Temp.- 3000K, 4000K, or 5000K settings
- Operating Temp.- -40°F to 122°F
- UL & CUL Listed, RoHS Compliant, CE, FCC

\$77.57 LIBL60



42 WATT FLUORESCENT WALLPACK REPLACEMENT BULBS

FLUORESCENT LIGHTS

- For use with electronic and dimming ballasts
- 4-pin base
- 82 CRI
- 4100 Kelvin
- Base: GX24Q-4
- Overall length: 6.5" (163 mm)
- 3200 Lumens

\$10.88 LIBF42



REPLACEMENT BULB LIFH04 & LIFH08

FLUORESCENT LIGHTS

- 54W Replacement bulb for LIFH04 & LIFH08

\$14.67 LIF54T5

REPLACEMENT LENSES & LIGHTING GUARDS



REPLACEMENT LENS AND LIGHTING GUARDS

HUBBELL LIGHTING



- Suited for security lighting applications as well as commercial and architectural exterior wall and area lighting
- One-piece polycarbonate front with high performance prismatic optics. Secures to housing gasket with twin Hubbell Gard® captive fasteners
- Die-cast aluminum housing allows firm mounting over recessed junction boxes or on flat surfaces for 1/2" surface conduit. Casting dissipates ballast heat for long life
- Specular aluminum reflector with kicker panels drive maximum lamp lumens to the refractor prisms. Vertical medium base lamp with these optics provide six-to-one spacing-to-mounting height ratio for maximum spacing or better uniformity. Vertical lamp increases both lamp life and output.
- Dark bronze powder paint finish standard on housing, front is painted inside the polycarbonate for lasting appearance.

\$75.38	LI0160	Polycarbonate lens/door for PVL3
\$264.35	LI0165	Glass lens for PGM3 (also the PGL)
\$133.65	LIG200	Polycarbonate shield for refractor for PGM3 or PVL3



**HAVE QUESTIONS?
TALK TO ONE OF OUR PROFESSIONAL CAR WASH EXPERTS LIVE ON OUR WEBSITE!**

Just click on the "LIVE CHAT" icon on our website to start a conversation with your car wash expert **TODAY!**

PULSE-START LIGHTING



PULSE START METAL HALIDE BALLAST

PULSE-START LIGHTS



- Metal Halide • 120/208/240/277V

\$84.50	LIHB250	250 Watt
\$94.50	LIHB400	400 Watt



PULSE-START BULBS

LSI PULSE-START



\$51.50	LIB320	320 W
----------------	---------------	-------



REPLACEMENT PULSE-START BALLASTS

HUBBELL LIGHTING



- Lighting luminaire component
- 60 Frequency Rating
- Suitable for outdoor use
- Non-dimmable
- Metal halide lamp type
- Magnetic HID

\$151.94	LI0270	For 150W Pulse Start
\$212.55	LI0272	For 250W Pulse Start

STILL HAVE THE SCOTTSDALE SURFACE MOUNT LIGHT?

We still carry parts and supplies to keep your fixtures functional!

BALLAST KIT FOR LIGS320

LSI PULSE-START

\$191.89	LIGS320B
-----------------	-----------------

PROBE-START LIGHTING



PROBE-START BULBS

OLD STYLE

PROBE-START LIGHTS

\$20.06	LIB175	175W-GE Bulb
\$24.34	LIB250	250W-GE Bulb
\$23.48	LIB400	400W-GE Bulb
\$31.50	LIBS175	175W-Sylvania Bulb
\$28.76	LIBS250	250W-Sylvania Bulb
\$28.25	LIBS400	400W-Sylvania Bulb

OLD STYLE PROBE-START REPAIR KITS

PROBE-START LIGHTS

\$121.19	LI0150	Ballast & Capacitor Set - 175 MHz
\$80.99	LI0155	Ballast 250W - Metal Halide
\$21.45	LI0260	Capacitor 175W - Hubbell

PROBE-START LIGHTING

VS

PULSE-START LIGHTING

Used w/ Traditional Metal Halide Lamps

3 Electrodes in Arc Tube

Ignition: Discharge across electrodes

Lamp performance deteriorates over time due to tube blackening

Used w/ Newer Metal Halide Lamps

High-voltage Ignitor

Ignition: Utilizes ballast to start using high-voltage pulses

Low sputtering for longer lamp life

PULSE-START LAMPS are utilized for newer metal halide lamps and should never be used for traditional lamps that are used with probe-start lights.

PULSE-START TECHNOLOGY provides up to 50% longer lamp life over older metal halide lamps. Lumen maintenance is 33% greater and pulse-start lights are able to start at lower temperatures as low as -40°F. Re-start times are also shorter.

ACCEPTORS & TIMERS

CURRENCY VALIDATORS



BILL ACCEPTOR WITH FLEXSTACK

PAYCOMPLETE/COINCO

PayComplete **COINCO**

- Accepts: \$1 - \$20 bills, four-way insertion
- Cashbox size: FlexStack - cashbox holds 200-500 bills
- Communication Interface: MDB
- Quick release bezel speeds installation and maintenance
- Optical stringing protection
- Streamlined bill path and intelligent bill transport software reduce jam conditions providing highest in-service time
- Bezel type: Basic
- Voltage: 34VDC
- Mounting orientation: Upstack
- Superior water protection
- Attention grabbing impulse lights

\$387.84	VX63B45US00	Basic bezel
\$365.75	VX63M45US00	Basic metal bezel for added durability



CURRENCY VALIDATORS

PYRAMID TECHNOLOGIES

PTI PYRAMID TECHNOLOGIES, INC.

- 12VDC standard, with 24VAC, MDB, and 120VAC power supply options
- Numerous interfaces available - pinouts compatible with other manufacturers
- Accepts bills up to 72mm wide for foreign applications
- Automatic self-calibration, never requires user calibration
- Lighted arrows on bezel and bill entry area
- Simple setup with configuration card
- Free currency upgrades
- Dual-stage optical anti-stringing
- High security against fraudulent bills
- Push-button/LED on-board diagnostics

\$13.50	PT05AA0012	Wall Plug Adapter
\$70.50	PT02AA3005	Universal 500 Note Plastic Cashbox For Apex And Spectra Stackers
\$290.41	PTAPEX7400-DB4	No Mag Head: \$1 - \$20 - Down Stacker - 500 Bill - MDB Harness
\$292.26	PTAPEX7400-UB4	No Mag Head: \$1 - \$20 - Upstacker - 500 Bill - MDB Harness
\$292.26	PTAPEX7401-DB4	No Mag Head: \$1 - \$20 - Coinco Bezel - Downstacker - 500 Bill - MDB Harness
\$271.78	PTAPEX7401-UB4	No Mag Head: \$1 - \$20 - Coinco Bezel - Upstacker - 500 Plastic Bill - MDB Harness
\$292.26	PTAPEX7402-UB4	No Mag Head: \$1 - \$20 - VFM Bezel - Upstacker - 500 Plastic Bill - MDB Harness
\$336.22	PTAPEX7600-UB3	Mag Head: \$1 - \$100 - Upstacker - 500 Bill - 120 VAC
\$293.55	PTAPEX7401-UB3	Coinco Bezel: Upstacker - 500 Plastic Bill non-locking plastic cassette - 120 VAC



Bill validators are the lifeline of a cash-intensive industry like the car wash industry, from tunnels, to bay boxes, to vending set-ups. Customers love the convenience of a fast, reliable transaction with minimal roadblocks. Being able to use their cash, without worrying about smoothing out every single crease and constantly inserting and reinserting, saves them time and makes it easy for them to spend more at your facility! Bright graphics and well-lit bezels make sure your customers don't have to wonder where to insert their bills.

At the same time, bill validators offer you great security in your cash transactions! Featuring everything from optical stringing protection, to anti-fishing barriers, to cash box lock outs, they allow you to be confident that only legit bills will be accepted, and that crooks won't be able to cheat you out of your business. High-security cash boxes keep your bills safe and sound for you to empty when convenient, with some high-capacity models offering storage for hundreds of bills. The newest models even feature automated diagnostics and wireless communications, to make your life easier!

ACCEPTORS & TIMERS

CURRENCY VALIDATORS



CPI TALOS VALIDATORS VALIDATORS

- Secures banknotes in speeds under 2.5 seconds
- Light Bar recognition system delivers best in class fraud detection
- Firmware updates via USB, increases update speed ten-fold
- Addresses new advances in banknote security
- Encrypted, secure, seamless updates
- 32-bit microprocessor with processing power to support enhanced features
- Enhanced security modes provide additional theft protection, early detection, and alarm triggering
- External error code access
- Replaces 2000 Series Bill Validators

CHANGES FROM 2000 SERIES:

- Light Bar recognition replaces Pellet Sensors
- No more dip switches
- Denomination acceptance programming w/ banknote or coupon
- Increased banknote transport speed
- New bezel designs - VFM & Compact applications
- Single high security mode
- USB supported updates

SIMILARITIES WITH 2000 SERIES:

- All bezel design types are compatible, including cashless
- Retro bill magazine compatibility
- Banknote transport & stacking mechanism performance
- Supports all OEM communication protocols & interface types
- Drop-in replacement for 2000 Series units
- Programming push button found behind the bill magazine

COINBOX VALIDATORS SPECIFY CHANGER AND MODEL VALIDATORS

\$507.43	T6T1-U5E	T6T1-U5EUS	\$1 - \$20 110VAC 500 Bill
\$434.99	T612-U3E	T612-U3E	\$1 - \$20 24VAC 300 Bill
\$548.69	T631-D7E	T631-D7EUS	\$1 - \$20 110VAC 700 Bill
\$537.07	T601-U7E	253100290P1	\$1 - \$20 110VAC 700 Bill
\$496.53	T602-U5E	T602-U5E	\$1-\$20 24 VAC 500 Bill



\$507.43	T612-U5E	T612-U5E	\$1-\$20 24 VAC 500 Bill
\$496.46	T7T2-U5M	T7T2-U5M	\$1-\$20 24 VAC 500 Bill
\$496.46	T702-U5M	T702-U5M	\$1-\$20 24 VAC 500 Bill
\$545.20	T632-D7M	T632-D7M	\$1-\$20 24 VAC 700 Bill
\$507.43	T611-U5E	253100261P1	\$1-\$20 110 VAC 500 Bill

\$130.61	MARSBOX300	300 Note
\$172.98	MARSBOX500	500 Note
\$170.48	MARSBOX700	700 Note
\$116.64	MARSBOX1000	1000 Note

COINCO VALIDATORS - VANTAGE SERIES (DIRECT REPLACEMENT FOR MARS) VALIDATORS



- Accepts: \$1 - \$20 bills, four-way insertion
- Cashbox size: 400 bills
- Voltage: 110 VAC
- Communication Interface:
MDB, Pulse, Parallel, Vend Serial
- Mounting orientation: Upstack
- Quick release bezel speeds installation and maintenance
- Streamlined bill path and intelligent bill transport software reduce jam conditions providing highest in-service time
- Superior water protection
- Optical stringing protection
- Attention grabbing impulse lights

\$474.32	VL61R44US00	110 Volt \$1-\$20 - 400 Note
\$474.32	VL61R45US00	110 Volt \$1-\$20 - Flex Stack

EVOLUTION COIN HOPPERS

PAYCOMPLETE



- A belt-driven model designed for high speed and easy service
- Used by American Changer and Namco CyberTainment
- Black Bulgin plug connector (same as Money Controls MK4 connector) - pulse or on/off
- Connector can be easily changed from front to back
- Includes mounting plate
- Voltage 24VDC
- Operating Temperature: 32° to 158°F
- 1500 quarter capacity

\$219.28	EV100-011B	Bulgin Connector and Parallel Interface
\$217.32	EV100-001B	Cinch Connector, Parallel Interface

ACCEPTORS & TIMERS

COIN ACCEPTORS & BILL VALIDATORS



**MULTITRON
WORLD EDITION**
GINSAN



- Accepts 30+ different coins
- Accepts coin size 0.64 - 1.26" diameter (16 mm - 31.5 mm)
- No permanent sample coin required
- 24 VAC and 24 VDC compatible
- Adjustable output pulse
- Program with or without external programmer
- Power loss will not affect memory
- Corrosion proof-chassis
- 2" mounting footprint

\$462.68 **CB0202**



SENSORTRON COIN ACCEPTOR
GINSAN



- Electronically size and accept any coin
- Accept any denomination coin (foreign or domestic) or desired token
- Automatically rejects and returns improper coin, token or slug
- 1 coin operation
- Requires 24 VAC power source. Available in either 2" (CB0201) or 3" (CB0200) faceplate
- Model CB0190 is a replacement insert only and does not include faceplate. Will work with either 2" or 3" faceplate

\$154.29	CB0201	2" Sensortron
\$153.89	CB0200	3" Sensortron
\$133.33	CB0190 (GS 41)	Insert Only



**SLUGBUSTER®
(OLD STYLE)**
PARKER ENGINEERING



- Long drop, single coin operation
- 2" face plate
- Operates on 24 VAC
- Has AC and DC credits
- Accepts quarters, tokens or dollar coins
- 2 year warranty

\$130.63 **CB0265**



**SLUGBUSTER® II SINGLE COIN
MODEL P-35**
PARKER ENGINEERING



- Single coin applications
- Quarter/token/dollar
- Operates on 24 volt AC/DC
- Available in long and short drop models
- E/Z clean coin path
- 2 year warranty

\$126.88	CB0280EZ	Short Drop
\$126.88	CB0290EZ	Long Drop



**SLUGBUSTER® II DUAL COIN
MODEL P-55**
PARKER ENGINEERING



- Dual coin applications
- Quarter/token, quarter/token
- Dollar coin not recommended
- Operates on 24 volt AC/DC
- No magnetic crediting
- E/Z clean coin path
- 2 year warranty

\$152.50	CB0260EZ	Long Drop
\$152.50	CB0275EZ	Short Drop



SLUGBUSTER® III
PARKER ENGINEERING



- Long and short drop models
- E/Z clean coin path, 3 coin operation
- Operates on 24 VAC or VDC
- Programmable pulse length
- 3 channel audit feature
- No magnet crediting
- 2 year warranty

\$196.88	CB0262EZ	Long Drop
\$196.88	CB0263EZ	Short Drop

ACCEPTORS & TIMERS

COIN ACCEPTORS

COIN VALIDATING EQUIPMENT

IMONEX COIN ACCEPTORS

IMONEX

- Durable, long-lasting materials, ends rust problems
- Ends alignment adjustments
- Anti-stringing device
- Resists salting
- Accepts 100% of good coins
- Replaces mechanical coin acceptors
- Reduces customer complaints and vandalism
- No moving parts or electrical requirements
- Available for car wash coin operated equipment (vacuums, air machines, coin meters, floor mat machines, etc.)

\$52.77	IMZ3Q	Quarter Only Mech
\$60.32	IMZ3TQ	Quarter/.984 Token Mech
\$18.32	IMS75968	Credit Switch



IMONEX INSERTS

IMONEX COIN ACCEPTORS

IMONEX

- Replace mechanical coin acceptors
- Reduces customer complaints and vandalism
- No moving or electrical requirements
- Resists salting

\$20.90	IM901	Insert US Coin
\$18.32	IMS75968	New (Credit) Switch/Terminal Up
\$15.85	IM906	.900 Token
\$25.98	IM907	.900 & U.S. Qtr.
\$25.11	IM914	.900 & .984 Token, U.S. Qtr.
\$20.90	IM901	U.S. Qtr.
\$20.91	IM901C	U.S. Qtr. & Canada Qtr.
\$25.11	IM909	U.S. Qtr. & .984 Token
\$25.11	IM908	.984 Token
\$33.66	IM928	Canadian Loonie



IMONEX ELECTRONIC SINGLE COIN Z32 ACCEPTOR (QUARTER)

IMONEX COIN ACCEPTORS

IMONEX

- Accepts U.S. quarter coins
- 2" W stainless steel faceplate with coin return button
- Removable credit switch cover
- Integrated anti-stringing coin race
- No moving parts - manual coin processing with no rockers/cradles to maintain
- Programmable DIP switches
- Operates with 12-24 Volt DC or AC power
- Single-piece design virtually eliminates coin jams and alignment problems
- Processes damaged coins - dramatically reduces downtime and need for service

\$135.62	IM206
-----------------	--------------



3" COIN MECHANISM

CM COIN ACCEPTORS



- Sturdy stainless steel construction complete faceplate assembly. Will not break if kicked or hit with a hammer
- Standard 3" width faceplate with stainless steel reject plunger
- Internal coin return cup with flap removed
- Accepts all mintings of U.S. Quarters

\$58.99	CB0203	3" Coin Mech
\$8.50	ST0301	Replacement Switch



2" COIN MECHANISM

CM COIN ACCEPTORS



- Sturdy stainless steel construction complete faceplate assembly. Will not break if kicked or hit with a hammer
- Standard 2" width faceplate (measure across faceplate) with stainless steel reject plunger
- Removable plastic coin return cup
- Microswitch
- Accepts all mintings of U.S. quarters

\$50.01	CB0212	Coin Mech Rejector
\$7.75	ST0305	Replacement Switch
\$70.60	CB0206	.900 Token Coin Mech
\$70.59	CB0212-CL*	\$1 Canada Coin Mech
\$45.28	CB0212-F*	Faceplate Only
\$59.94	CB0212-QT*	U.S. Quarter & .984 Token
\$70.60	CB0212-QT900*	U.S. Quarter & .900 Token
\$51.94	CB0213*	Face Plate Assembly with U.S. Quarter. Comp.

*NOW WITH A .205" TERMINAL MICROSWITCH



US & CANADIAN COIN INSERTS (WITHOUT MAGNET)

CM COIN ACCEPTORS



- U.S. Quarter coin insert used exclusively in all Laurel Metal Products Drop Shelf Vendors
- Simple adjustment process
- Accepts both U.S. and Canadian quarters in one coin insert
- A magnet is used on all other coin inserts to catch counterfeit coins
- Easy to replace or convert in the field with a screwdriver
- 4 mounting studs on each corner

\$35.97	CB0219	Coin Mech Insert without magnet
\$37.30	CB0219-1	\$1 U.S. Coin Mech Insert
\$27.91	CB0218	U.S. Coin Insert (with magnet)
\$31.00	CB0220	.50 Euro Cent Coin Mech Insert
\$31.90	CB0252	Token Insert Only .984
\$34.65	CB0251	.984 Token/.25 mech
\$4.96	CB0222	Coin Catcher Kit (with screws)
\$27.77	CB0224	U.S. Qtr. Mech Insert Only (for Vac)
\$39.95	CB0253	1.073 Token Insert



ACCEPTORS & TIMERS

COIN ACCEPTORS, PARTS & ACCESSORIES



IDX MA-850 HAWK XEPTOR®

IDX COIN ACCEPTORS



- Standard 2" faceplate footprint of 2"W x 7.75"H x 3.8" D
- Power sources 24 VAC/VDC standard optional voltages - 12VDC
- Accepts up to 6 coins & or tokens
- Coin Sizes Accepted: Diameters 0.832" to 1.126" and Thickness 0.059" to 0.085" other sizes available
- Standard 4 wire hookup
- Slide-on water resistant access covers
- Built-in "Credit Test" push button
- Pre-programmed for U.S. quarters and U.S. dollar coins
- Unwanted shadow coin feature eliminates false acceptance of undesired coins
- Optional: Anti-String Optics can be added to any MA850

\$278.96

IDXMA850

IVS/Ginsan, Doyle, JE Adams, Etowah, Dralco, D&S, Ntl. Pride

REPLACES
THE MA-800



IDX X-12 X-MARK XEPTOR®

IDX COIN ACCEPTORS



- Standard 2" faceplate footprint of 2"W x 7.75"H x 3.8" D
- Accepts mixture of 6 different coins, can be a combination of currencies, tokens or encoded security tokens
- Built-in coin release opens the chute to drop through bent and mutilated coins
- Power sources 24 VAC or 24VDC standard optional voltages - 12VDC
- Coin Sizes Accepted: Diameters 0.832" to 1.126" and Thickness 0.059" to 0.085" other sizes available
- Built-in water resistant access covers
- Built-in "Credit Test" push button
- Multi-color indicator LED for operational status
- Optional: Anti-String Optics can be added to any X-12

\$317.16

IDXX12-5A

5A - For Bays/Vacs, Ginsan, JE Adams, Jim Coleman, Ryko

\$317.16

IDXX12

39 - Bays/Vacs, Exact One

REPLACES
THE X-10



IDX X-12 X-MARK XEPTOR®

IDX COIN ACCEPTORS



- Standard 2" faceplate footprint of 2"W x 7.75"H x 3.8" D
- Use with Framagmatic units with Quick-Connect Plug
- Preprogrammed for U.S. quarter and dollar coins, changeable in field
- Coin Sizes Accepted: Diameters 0.832" to 1.126" and Thickness 0.059" to 0.085" other sizes available
- Multi-color LED indicator
- Slide-on water resistant access covers
- 24VAC or 24VDC electrical connection
- Built in coin-release chute to drop bent coins and reduce jams

\$258.92

IDX12CF5A0C34F

5A - Accepts X-Mark or Smart Mark encoded security tokens



COIN ACCEPTOR FOR AIR MACHINE

IMONEX COIN ACCEPTORS



- IMONEX® patented, no moving parts, manual coin processing system
- Dramatically reduces coin related service calls and machine downtime
- One piece acceptor/bracket assembly; no alignment necessary
- For U.S. and foreign coin
- Hinged gate area for inspection
- Injection molded for high tolerance consistency
- Durable plastic does not sweat or corrode like metal

\$42.49

IM783



U.S. PARAP LATE TIMER

U.S. PARA PLATE



- 24 or 120 Volt
- For coin boxes or vacuum
- Up to 15 coins

\$108.80

VA24400



EUROPEAN REJECTOR & REPLACEMENT SWITCH

COIN ACCEPTORS

- Fits Monorail vacs and coin boxes

\$89.66

CB0205

Rejector

\$19.33

ST0300

Replacement Switch



IMPULSE COIN COUNTER

KESSLER ELLIS PRODUCTS

- Non-resettable
- Available in 24 and 110 Volt

\$16.71

CB0255

24 Volt

\$16.71

CB0256

110 Volt



15080 MONORAIL ACCUTIMER

INFITEC

- 24 Volt Timer
- Fits Monorail G2 vacs and Monorail coin boxes

\$98.33

CB0301



VERTICAL 8 CHUTE

GREENWALD INDUSTRIES

- \$0.25 price option
- Anti-cheat gate
- Stainless coin sizing clots
- The industry standard

\$51.67

GR20-1000-1

ACCEPTORS & TIMERS

COIN ACCEPTORS



MICROCOIN QL NATIONAL CARWASH SOLUTIONS

- This coin acceptor is a high-speed, multi-coin, field-programmable device. It is designed to operate in any coin-operated application, ranging from gaming through vending, amusement, and car wash.
- For "front entry" applications
- Can be fitted into any top-entry application with ease by virtue of its industry standard size and mounting pin positions
- Validator has a patented discrimination technology which allows it to accept up to 12 different coins or tokens at speeds up to 10 coins per second. The coins travel along a highly engineered coin path which accepts or rejects the coins at speed without compromising the operation of the validator.
- Comprehensive, handheld one-button programming - Up to 5 additional coins may be "quick learned"
- Standard 4 Wire Hook-Up - 24 VAC, common, 2 coin pulse wires
- No Interface Board Required
- Anti-Jamming Design
- Dimensions: 7¾" x 2" x 4"
- On-Board Diagnostics
- Easy Internal Access
- Coin Thickness: 1.0mm to 3.4mm
- Bracket: Long Drop Style
- Computer Programmable
- Electronic & Mechanical Anti-Stringing
- Coin Diameter: 16mm to 34 mm

\$322.56	MCS5T	\$32.48	MCS5BRKT	Replacement bracket with face plate
		\$29.25	MCS361IF	Replacement Microcoin QL Val board

5 COIN EP-5 PLUS - PROGRAMMABLE ACCEPTOR MAGIKIST



- Long and short drop
- Rugged and waterproof
- Variable pulse width
- Industry standard hook-up
- Also Available: Custom configurations for European coins, security tokens & digital applications. Call for details!
- Simple to program
- AC and DC switch out
- 3 tolerance levels
- 2 year warranty
- Easy-read status display
- No sample coins required
- Precision discrimination

\$199.99	SECEP5LD	5 Coin Mech. (Long Drop)	\$258.63	SECEP5SD-E	European Short Drop
\$222.13	SECEP5SD	5 Coin Mech. (Short Drop)			
\$222.13	SECEP5LD-C	Canadian Long Drop			
\$247.74	SECEP5SD-C	Canadian Short Drop			



TIMERS

TIMEMASTER TM5-CU COUNT-UP READOUT BAY TIMER NATIONAL CARWASH SOLUTIONS

- The Timemaster TM5-CU Count-Up Readout Bay Timer is a reliable timer with an easily readable fluorescent display. Perfect for coin-operated self-serve car wash bays, this quality timer is housed in a high-impact plastic case and fits most coin boxes. Timemaster provides precise timing control to assure you and your customers the ultimate in performance and reliability!

SPECIFICATIONS:

- Input Voltage: 24 VAC
- Output Voltage: 24VAC
- Horn Voltage: 12VDC
- External Coin Counter Voltage: 24VAC
- Mounting: Shelf-mounted and secured by a wing nut
- Memory Backup: EEPROM retains all programming in the event of a power failure

DIMENSIONS:

- 3¾" width x 1¾" height x 3" depth

FEATURES & INFO:

- Housed in a water-resistant, high-impact plastic case and is designed to fit most coin boxes
- Last Minute Alert: Programmable from 1 to 59 seconds
- Display: Blue-green vacuum fluorescent display for maximum visibility, Price to start is displayed when the timer is not in use. As coins are accepted, the timer displays the balance due to start the wash. The timer's beeper is sounded with each accepted coin providing the customer with an audible confirmation of operation as well as the visual display.
- Bonus Time: Programmable from 0 seconds to 4 minutes.
- Grace Time: Programmable from 0 to 59 seconds
- Changeover Time: Product changeover for low pressure products frequently takes 10 to 20 seconds. Customer satisfaction can be improved if your timer pauses during product change over. Timemaster offers this feature for up to 4 different products. The pause time is programmable from 1 to 59 seconds.
- Controls: Initial programming is accomplished by mode and set switches located on the back of the Timemaster. The RC-1 is an optional infrared remote controller that permits programming changes, taking counter readings (from the built-in coin counter), testing equipment and bay wash down without coins or test switches. The "TEST" feature is programmable from 1 to 10 minutes of test time. A user programmable security code allows operator access to these features.

\$475.50	TM5-CU	Timemaster
\$124.28	CB0313R	Remote Controller



ACCEPTORS & TIMERS



TIMERS



TIGS401 24V ACCUMULATIVE TIMER

REPLACES TIGS255, TIGS87
TIGS8, TIKR255

GINSAN TIMERS

- Input Power: 20 - 32 VAC
- Power Output: 24 VAC
- Time Per Coin: 1 - 511 seconds
- Coins to Start: 1 - 31 coins
- Coins Accumulated: 1 - 255 coin pulses
- Quick Restart Time: 1 - 60 seconds
- Low Time Alert: 1 - 120 seconds
- Overload Protection: Built in
- Display: # coins or tokens accepted
- Warranty: 2 years

\$152.85 TIGS401



TIGS402 24V ACCUMULATIVE TIMER

REPLACES TIGS-7 & TIKR-7

GINSAN TIMERS

- Input Power: 20 - 32 VAC
- Power Output: 24 VAC
- Time Per Coin: 1 - 511 seconds
- Coins to Start: 1 - 31 coins
- Coins Accumulated: 1 - 255 coin pulses
- Quick Restart Time: 1 - 60 seconds
- Low Time Alert: 1 - 120 seconds
- Overload Protection: Built in
- Display: # coins or tokens accepted
- Warranty: 2 years

\$70.21 TIGS402



TIGS403 ACCUMULATIVE TIMER

REPLACES TIGS-9, TIKR-9,
TIGS-11 & TIGS-101

GINSAN TIMERS

- Vacuum Motors Driven: 3 motors
- Time Per Coin: 1 - 511 seconds
- Coins to Start: 1 - 31 coins
- Coins Accumulated: 1 - 255 coin pulses
- Overload Protection: Built-in
- Warranty: 1 year

\$132.12 TIGS403



TIGS404 24V ACCUMULATIVE DUAL TIMER

GINSAN TIMERS

- Standard timer input with additional premium service input
- Input Power: 24 V
- Time Per Coin: 1 - 511 seconds
- Coins to Start: 1 - 31 pulses
- Time Per Coin Premium: 1 - 511 seconds
- Coins to Start Premium: 1 - 31 pulses
- Low Time Alarm: 1 - 120 seconds
- Quick Restart Time: 1 - 60 seconds
- Warranty: 2 years

\$177.41 TIGS404



TIGS405 120V ACCUMULATIVE DUAL TIMER

GINSAN TIMERS

- Standard timer input with additional premium service input
- Input Power: 120 V
- Time Per Coin: 1 - 511 seconds
- Coins to Start: 1 - 31 pulses
- Time Per Coin Premium: 1 - 511 seconds
- Coins to Start Premium: 1 - 31 pulses
- Low Time Alarm: 1 - 120 seconds
- Quick Restart Time: 1 - 60 seconds
- Warranty: 1 year

\$216.77 TIGS405



TIGS408 230V ACCUMULATIVE VACUUM TIMER

GINSAN TIMERS

- Input Power: 230 V
- Time Per Coin: 1 - 511 seconds
- Coins to Start: 1 - 31 coins
- Timer will accumulate coins deposited when operational
- Timer will accommodate up to three vacuum motors
- Warranty: 1 year

\$169.84 TIGS408

ACCEPTORS & TIMERS



TIMERS

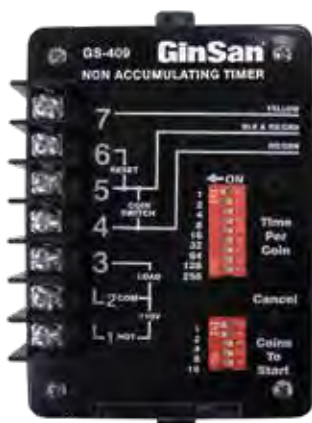

TIGS409 120V NON-ACCUMULATING VACUUM TIMER

GINSAN TIMERS

- Input Power: 120 V
- Time Per Coin: 1 - 511 seconds
- Coins to Start: 1 - 31 coins
- Timer will not accumulate coins when operational
- Timer will accommodate up to three vacuum motors
- Warranty: 1 year
- **THIS TIMER IS IDEAL FOR COMMERCIAL OR FREE VACUUM APPLICATIONS AS IT WILL ENSURE THE MOTORS SHUT DOWN AFTER EVERY CYCLE**

\$148.96 TIGS409



TIGS410 220V NON-ACCUMULATING VACUUM TIMER

GINSAN TIMERS

- Input Power: 220 V
- Time Per Coin: 1 - 511 seconds
- Coins to Start: 1 - 31 coins
- Timer will not accumulate coins when operational
- Timer will accommodate up to three vacuum motors
- Warranty: 1 year
- **THIS TIMER IS IDEAL FOR COMMERCIAL OR FREE VACUUM APPLICATIONS AS IT WILL ENSURE THE MOTORS SHUT DOWN AFTER EVERY CYCLE**

\$167.98 TIGS410



TIGS415 24V NON-ACCUMULATING TIMER

GINSAN TIMERS

- Input Power: 24 V
- Time Per Coin: 1 - 511 seconds
- Coins to Start: 1 - 31 coins
- Timer will not accumulate coins when operational
- Warranty: 2 years
- **** IDEAL FOR FREE SERVICES UTILIZING 24V ACTIVATION**

\$175.67 TIGS415



TIGS30 TRIPLE FOAM TIMER

GINSAN TIMERS

- Cycles 3 time-adjustable outputs
- Requires 24 VAC for operation
- Used in Kleen-Rite Triple Foam Unit & can be used as a replacement timer in other triple foam units

\$183.99 TIGS30



TIGS20 AUDIBLE ALERT KIT

GINSAN TIMERS

- Buzzer activates for first 10 seconds of last coin's worth of time
- 24 V light connected to unit will flash for entire last coin's worth of time
- Used with TIGS401 or any timer with low time alert output

\$165.80 TIGS20



TIGS16D FOR RO PUMP CONTROL

GINSAN TIMERS

- Reverse osmosis pump control with input for 12 bays
- Output operates after 1 second delay

\$176.16 TIGS16D



TIGS26 VAC DRIVER

GINSAN TIMERS

- 24V power to operate and also drives vacuum motors
- No need for transformer and relay

\$250.84 TIGS26



GinSan has been the leading manufacturer of timers for nearly a quarter of a century with more than 100,000 GinSan timers in service throughout the world. Ginsan timers have a history of dependability and split second accuracy and are backed by a 2-year warranty, unsurpassed in the industry!

ACCEPTORS & TIMERS

TIMERS



GS-400 COUNTDOWN DISPLAY TIMER

GINSAN INDUSTRIES



- Event Cycles: Two field-adjustable levels (start up value & time can be adjusted)
- Programmable Wash Greeting: 32 character maximum (Message will scroll depending on length)
- Language Options: English, Spanish, German and French
- Currency Options: dollars, tokens, Euros and Pesos
- Bonus (Time) Levels: Three field-adjustable levels
- Quick Restart Time: 1-60 seconds (adjustable)
- Start Up Delay: 1-30 seconds (adjustable)
- Timer Activation Values: .01 - \$99.00
- Pulse Accumulation Maximum: 255
- Low Time Alert: 1-60 seconds (adjustable)
- 24 V System
- Timer Cycle: 0-99 minutes
- Beeper Volume (Adjustable)

\$318.11	TIGS400	Digital Display Timer
\$34.50	GS77115	Optional Remote



IDX GT200-A GIGA DISPLAY & TIMER

IDX TIMERS

- Patented Two-Time Select - Great for higher price chemicals, combo vacuum, promotions and specials
- 10 separate programmable times and/or coins to start with programmable messages used in combo vac, for extra specials, pet wash, etc
- Audit shows total coins, total time on A&B, with model GT200-A total \$ of bills, total credit card in \$ or time
- Footprint interchangeable with LTT802 timers and most other meter box small timers
- Credit Card protocol with Selectable Count down or Count Up Modes
- 2 programmable cycle times each from 1 sec to 99 minutes
- 3 scrolling 127-character programmable messages
- Selectable Lucky Time, Giga Time, Bonus Time programs
- Multi voltage input 12VAC/DC to 28VAC or 32DC
- Programmable coin base \$0.05 / \$0.20 / \$0.25 / \$0.50 / \$1.00
- Reset for Giga Time
- Separate input for bills & credit card
- Field settable LED brightness levels
- 2-year warranty on LED's
- 24+% less current draw
- 5 amp replaceable fused output
- Coin and bill acceptor disable wire

\$416.68	IDXGT200A	GT200-A Timer	For Vacs/Meters using optional services board
\$314.02	IDXGT200	GT200 Timer	Replacement for LTT802 Series Timers (no service board)

IDX GT912 GIGA DISPLAY & TIMER

IDX TIMERS

- Card-display protocol
- 3 scrolling 127-character programmable messages
- 2 programmable cycle times each from 1 second to 99 minutes
- 2-year warranty on material/workmanship
- Display brightness field-programmable with 3 settings
- Adjustable display brightness based on timer's activity
- Operating voltages: 12VAC/DC to 28VAC to 32DC
- Relay input internal fused with replaceable 5 amp fuse
- Dual time/value accumulating timer for multi-value services
- Counts up dollar value as coins are deposited, counts time down when running
- Horn output is used for "X-Tra" time, "Last Minute Alert", "Bonus Time", "Giga Time/Unlimited Time" and coin deposit beep if horn is installed
- 20%+ Less power required compared to the Big Time series of display timers

\$700.08	IDXGT912-I	Giga-Time Big Two Timer - IVS**	**IN POLYCARBONATE CASE
\$700.08	IDXGT912-D	Giga-Time Big Two Timer - D&S**	



Accumulating timers remove the constraints normal timers face. For example, a customer is no longer locked into a preset time limit when washing their vehicle. A normal timer ends the wash when the time is up. However, an accumulating timer warns the customer that their allotted wash time is coming to an end and offers them a window to add more time by inserting more coins.

Most timers will have a display where customers can visually see how much time is remaining enabling them to determine if they will need more time as the time winds down. As long as customers continue inserting coins, they are able to use your bay until their vehicle meets the customers standards of clean. Accumulating timers increase your profit per customer by keeping them in your bays longer. Install accumulating timers in your self-serve bays, vacuums, and dog washes to improve the experience of your customers.

ACCEPTORS & TIMERS



TIMERS

AT300 BY IDX

IDX TIMERS

- The New IDX AT300 series of accumulating timers can be used in vacuums or bays. This series of timer has been designed to replace the Specialties Mfg timer model "Time Machine" timer. It will also replace other manufacturers' timers with the same footprint. IDX has designed this timer to operate over a wide input voltage range to meet the new demands of our industry. This timer has the widest range of operating voltages; 12VDC to 40VDC & 12VAC to 28VAC. The AT300 was designed to be able to integrate into the new application markets that are requiring lower power consumption like solar and/or battery powered systems. To ensure a long life, the main output is a 5 amp AC relay.
- The AT300 standard features include the same footprint as Specialties' "Time Machine" timer, horn output wire to activate the LC525-AC (not included) 24VAC horn for coin in beep and "X-Tra Time" features. If no coins are deposited before the "X-Tra Time" period expires, the AT300 timer resets and the defined number of coins to start must be deposited, which starts a new cycle.
- Operating voltage: 12VDC TO 40VDC, 12VAC to 28VAC
- Exact foot print - size 5.625"L x 3.125"W x 2.0625"H
- 5 Amp AC contact relay output
- 1 to 15 coins to start
- Accepts 256 coin inputs without resetting
- Select coin time from 2 seconds to 8.50 minutes per coin
- Last alert output and coin-in beep
- Optional 3-7 segment display (AT300DB-3S7) easily added using internal connector on main board. Display option connector internal for part # IDXAT300DB-3S7
- Standard IDX wiring configurations and colors



All IDX Timers & Display-Timers have quartz crystal timing accuracy of .05% and are therefore guaranteed to have a maximum error of 0.12 seconds over a typical 4 minute wash cycle.

\$180.00	IDXAT300	IDX Timer
\$198.49	IDXAT300DB-3S7	IDX Display



AT411E BY IDX

IDX TIMERS

- Accumulating coin input - 256 max
- 1 to 15 coins to start
- Flat pack timer 2 seconds to 8.5 minutes per coin
- Input & output: 120 VAC or 24 VAC
- (2) 25 Amp SCR outputs mounted on heavy duty aluminum heat sink

\$117.60	IDXAT411E	Standard
\$127.87	IDXAT411EX	Extra Time Option



AT413 BY IDX

IDX TIMERS

- 24 VAC (2.5 VA, .1 amp) coin acceptor output
- Accumulating coin input - 256 max
- 1 to 15 coins to start
- Flat pack timer
- Input & output: 115 VAC
- (2) 25 Amp SCR outputs mounted on heavy duty aluminum heat sink

\$180.25	IDXAT413	115 VAC
-----------------	-----------------	---------



PROGRAMMER FOR ALL IDX DISPLAYS & DISPLAY TIMERS SERIES GT, BT & LTT

IDX TIMERS

- User can change the messages, time and retrieve coin counts

\$198.35	IDXRC800
-----------------	-----------------

Consider your customer base when choosing timers and acceptors for your clients to use.

By offering multiple languages for your timers and acceptors, you may find you can increase your customer base and profitability!



ACCEPTORS & TIMERS

TIMERS



24/120V VAC OR BAY TIMER

KLEEN-RITE TIMERS

KLEEN-RITE

- Accumulates 1 - 255 coins
- Cancel button
- Economical replacement for other dual voltage timers
- Last coin indicator output
- Encapsulated to withstand harsh environments
- Easily configurable: installation is quick and simple
- 0.5% repeat accuracy

\$49.77	TIKR84C	Multi Voltage - 24V/120V
\$48.86	TIKR54C	120V
\$48.86	TIKR64C	240V



120V VAC TIMER

KLEEN-RITE TIMERS

KLEEN-RITE

- Accepts 1 to 15 coins but does NOT accumulate
- 30 AMP output
- Microcontroller based circuitry
- Multiple time delay selection
- Dual control: no interfacing totalizer and timer
- Encapsulated to withstand harshest environment

\$45.04 **TIKR505**



DIP SWITCH TYPE MODEL

KLEEN-RITE TIMERS

KLEEN-RITE

- Accepts 1 - 15 coins
- 20 amp output
- Dip switch time delay
- Reliable, accurate and adjustable in all ranges

\$48.32	TIKR540	120V
\$48.32	TIKR440	24V
\$48.32	TIKR640	220V
\$46.22	TIKR84	24/120V
\$50.27	TIKR84C-NA	24/120V Non-Accumulating



24V TIMER

KLEEN-RITE TIMERS

KLEEN-RITE

- 1 - 31 coins to start
- Cancel button
- Accumulates up to 255 coins worth of time
- Overload reset
- Replacement for GinSan GS7

\$71.76 **TIKR402**



110V TIMER

KLEEN-RITE TIMERS

KLEEN-RITE

- 1 - 31 coins
- Ideal for vac upgrades
- Has 24V output for Sensortron hookup
- Replacement for GinSan GS9

\$127.72 **TIKR403**



INFITEC VEND 2000

INFITEC

infitec

- Dual voltage
- Isolated low voltage coin switch
- DIP switch time delay
- Accumulates 1 - 15 coins
- Cancel button

\$68.44 **TIKR2000**



REMOTE CONTROL SYSTEM RECEIVER

INFITEC

infitec

- Wireless push button remote control allows customers to receive free use for the normal cycle time
- The optional 'Free Service' can be activated by the attendant or the cashier with the push of a button for customer convenience
- Free Air Remote Receiver/ Timer
- 20 Amp contacts
- Works with all machines
- Use with RC1433-B Transmitter

\$250.52 **RC1433-C**



REMOTE CONTROL SYSTEM TRANSMITTER

INFITEC

infitec

- Wireless push button remote control allows customers to receive free use for the normal cycle time
- The optional 'Free Service' can be activated by the attendant or the cashier with the push of a button for customer convenience
- Free Air Remote Transmitter
- Use with RC1433-C Receiver

\$63.50 **RC1433-B**

ACCEPTORS & TIMERS

DIXMOR TIMERS & PARTS



ULTIMATE TIMER

DIXMOR TIMERS

- Giant 3½" x 11¼" dot matrix LED display
- Programmable, moving sign board type display
- "Last minute warning" horn output
- Water tight stainless steel enclosure 19" x 8½" x 1½"
- All standard features plus many more
- Programmable weekly or daily specials
- Remote turn on/off timer output
- Real time controlled 2nd schedule

\$720.90 DMD2002



LED9 BAY TIMER WITH STAINLESS STEEL CASE

DIXMOR TIMERS

- Super bright 2¼" X 7¾" numbers & letters
- 12¼" x 8" x 2" stainless steel enclosure
- Last minute warning output
- Remote washdown
- Multi-function version available
- Credit card compatible
- Bonus time & courtesy time
- Built-in inventory features
- Fully operator programmable

\$520.29	DM9SS	Single Function
\$548.63	DM9MFSS	Multi-Function



LED9 RETROFIT KIT

DIXMOR TIMERS

- Includes a board with LED9, bracket, and hardware. Add to popular brand timers to upgrade your display.
- Dixmor OEM replacement part
- Board with LED display
- Bracket and hardware included

\$340.30 DM9-RETROFIT

CASE NOT INCLUDED



LED9 DISPLAY TIMER

DIXMOR TIMERS

- 2¼" x 7¾" dot matrix display
- Multi-function timer capable of controlling six different functions
- When function changes, timer recalculates time remaining
- Operator programmable messages for function name and/or welcome message
- Standard features - bonus time, courtesy time, remote control, bilingual standard messages
- Enclosed in watertight ABS plastic case - 3½" x 9½" x 3¼"
- Also available as a single function timer for self-serve bay use
- Can be installed in the DX300 case and DMD300H hood

\$418.40	DM9	Single Function
\$443.70	DM9MF	Multi Function



DRYER TIME DISPLAY

DIXMOR TIMERS

- Dryer Time Display with 4" numbers
- Counts down in seconds or in minutes
- 9½" x 11" x 2" stainless enclosure
- One-pulse start - No timed output
- Standard 110 V

\$462.39	DMD200	Display	\$366.29	DMD200-CB	Circuit Board
\$312.55	DMD200-S	Dryer Pedestal	\$18.99	DMD200-LOCK	Lock
\$140.00	DMD200H	Hood Only			
\$462.41	DMD200-24	Display 24V			

DMD200 comes with back-light behind dryer time numbers

ACCEPTORS & TIMERS

DIXMOR

DIXMOR TIMERS & PARTS

New!



LED8 DISPLAY TIMER

DIXMOR TIMERS

- 2½" x ¾" dot matrix display
- Combines the display of the LED6 with the frame to sit in the same faceplate as an LED7
- Accumulates up to 99 minutes and 59 seconds with the left 2 zeros flash during last minute
- Easily programmed with 2 push buttons
- Built-in resettable counter for inventory check and memory back-up if power fails
- Harness included

\$325.00 DMLED8



LED7 DISPLAY TIMER

DIXMOR TIMERS

- 1 - 200 coin start
- Left 2 zeros flash during last minute
- Accumulates up to 99 minutes and 59 seconds
- Additional coins any time during operation
- Adaptable to any coin acceptor
- NVRAM memory - no program loss if power fails
- Your choice of adjustable last minute warning or continuous last minute horn output
- **MUST USE CB0316-SERIAL FOR WASH GEAR CREDIT CARD SYSTEMS**
- 1 - 599 seconds per coin
- Continuous time remaining display
- Easily programmed with 2 push buttons
- Friendly greeting displayed when not in use
- Friendly message displayed when time runs out
- Built in resettable coin counter
- Credit card input with many advanced features

\$262.87 CB0316



LED6 VAC/BAY TIMER

DIXMOR TIMERS

- Standard 24VAC timed output, 4 extra I-O's for combo machines
- Two separate time and price settings. One for timing standard output, one for timing extra outputs.
- Credit card input with advanced features: count up in time or money, display programmable message during count up
- All the standard features of the LED5 and LED7 Timers
- Shelf mount timer - case size 3½"W x 2"T x 3"D
- Super bright red dot matrix LED Display 2½" x ¾"

\$332.99 DMLED6

LED6-S MULTI-FUNCTION COMBO TIMER

DIXMOR TIMERS

- Vac/bay timer to replace Coleman™ 1034R

\$354.79 DMLED6-S



DIXMOR TIMER PARTS

DIXMOR TIMERS

PRICE	TIMER	ITEM/HARNESS	DESCRIPTION
\$7.00	LED3/LED7/ LED8	CB0321	Plug & Wiring Harness
\$7.00	LED5/LED6	CB0321-6	
\$14.50	LED6S	CB0321-6S	

PRICE	ITEM/HARNESS	DESCRIPTION
\$4.70	CB0318	3" x 3" Lexan Cover
\$10.27	CB0319	Horn for 12/24 VDC Timer
\$1.95	CB0320*	Decal - Last Minute Alert
\$8.50	CB0322	Case Only. For LED3 or LED7 Timer
\$7.12	CB0327	Mounting Bracket for TM3, TM5, DM5
\$33.99	DM5R	Remote for DM5, CB0316, DMD2002

* HAZARDOUS MATERIAL



DIXMOR ENTERPRISES has been manufacturing quality products since 1986. Located in Littleton, Colorado, they are always working to develop better ways to make your work easier.

BAY ACCESSORIES

WRINGERS & SINKS

THE HANDWRINGER BY LAKE CITY

LAKE CITY INDUSTRIES



C-CLAMP STYLE

- Removes twice as much water as spin dry!
- Has adjustable spin
- Attach to stationary or portable tubs (round or square)
- Rust-resistant, all steel frame, steel tube handle, and zinc plate finish
- Removes 90% of water from items
- Clamps open to 1 $\frac{3}{4}$ "
- Equipped with rolls 12" x 1 $\frac{7}{8}$ "

\$275.00 HW763

REPLACEMENT PARTS FOR THE HANDWRINGER BY LAKE CITY

LAKE CITY INDUSTRIES

\$46.70	HWP80135	Top Assembly	\$46.70	HWP25105	Crank Handle Complete
\$29.32	HWP3270	Wooden Block Bearing Set	\$151.53	HWP4200	Upper/Lower Roll Set



TWO PART HAND WRINGER CONVERSION KIT

LAKE CITY INDUSTRIES

- Convert your Lake City hand wringer into a flat-mount base wringer - similar to a Dyna-Jet wringer. The kit contains two identical metal parts that are attached to the wringer to make the conversion.
- Durable metal construction
- Converts a Lake City wringer to a flat-mount wringer (Dyna-Jet type)

\$24.37 HW763-CK



FREE STANDING STAINLESS STEEL SINK

DRALCO

- 36" H x 50 $\frac{1}{4}$ " W x 16" D
- 2 faucet holes
- 1 $\frac{1}{2}$ " drain
- Handwringer NOT INCLUDED

\$1,486.36 HWD5718

HANDWRINGER NOT INCLUDED

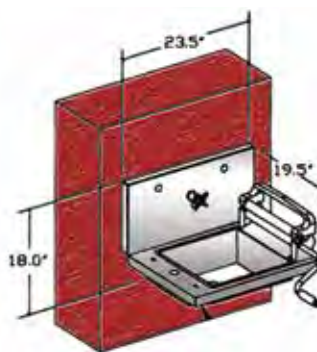

WALL MOUNT STAINLESS STEEL SINK

DRALCO

- 18" H x 23 $\frac{1}{2}$ " W x 19 $\frac{1}{2}$ " D
- Includes solenoid and faucet handle cutouts
- Drain Outlet: 1" FPT
- Handwringer NOT INCLUDED

\$726.92 HWD3287

HANDWRINGER NOT INCLUDED



HWPB

HWKRSINK

STAINLESS STEEL WRINGER SINK

FOR HANDWRINGERS

- 24" H x 15" W x 16" D
- Perfect for mounting handwringer
- Also available: Push Button Water Package

\$282.42 HWKRSINK Wringer Sink

\$152.48 HWPB Water Button Kit



WALL MOUNT STAINLESS STEEL SINK

FOR HANDWRINGERS

- 8" H x 17 $\frac{3}{4}$ " W x 16 $\frac{1}{4}$ " D
- Handwringer NOT INCLUDED

\$294.99 HWSINK

BAY ACCESSORIES

KLEEN-RITE GUN & BRUSH KITS



LOW PRESSURE FOAM BRUSH BUNDLE

KLEEN-RITE KITS



- An essential kit with all the components needed for your foamy brushes. This kit is very cost-efficient for quick repairs or setting up a brand new foam brush station at your car wash.

KIT INCLUDES:

- (1) 711A40MFV Blue X-tra Heavy Duty Coated Aluminum Foamy Handle
- (1) KR1102-BL Hog Daddy Hogs Hair Brush Blue - 4"
- (1) HA156FBL1443 Blue Foamy Hose - 3/8" MPE, 3/8" MSE, 15'
- (1) 5055 (SWV-1000) Economy Low Pressure Swivel 3/8" M x F

\$98.46 KRK2070



HIGH PRESSURE WEEP GUN/HOSE ASSEMBLY KIT

KLEEN-RITE KITS



- Get the essential parts for weep guns at your facility all in a convenient assembly kit! Includes all the parts you need to get your weep gun started.

KIT INCLUDES:

- (1) GUK600W Weep Gun with Blue Trigger
- (1) HA156WBL1414 Blue Single Wirebraided Hose 3/8" MPE
- (1) 22002 GinSan Blue Nozzle Protector 1/4"
- (1) 2506 Spraying Systems Stainless Steel Spray Nozzle 1/8"
- (1) SW-504A Fluid Controls Brass Ball Bearing Swivel 3/8" F x M
- (1) 291G18MF Blue Rubber Flex Wand 1/4" M x 1/8" F, 18"

\$99.50 KRK2080



HIGH PRESSURE COMFORT WEEP GUN ASSEMBLY KIT

KLEEN-RITE KITS

- Provides smooth operation in high-pressure spraying applications. Ready for use in self-serve bays with the addition of a spray nozzle of your choice (sold separately). Customers can enjoy consistent and comfortable spraying and rinsing. This is a weep style spray gun that keeps water moving through the gun to avoid freezing.

KIT INCLUDES:

- (1) GUK600W High-Pressure Weep Gun
- (1) WTL22003 18" Insulated Lance
- (1) WTS418 18" x 1/4" Stainless Steel Wand
- (1) NPGSBK 1/4" Nozzle Protector
- (1) GUG22046 Black Rubber Gun Guard
- (1) WTL22004 Handle Snap Clip

GUK600W GUN SPECIFICATIONS:

- **MAX. PSI:** 4000
- **FLOW:** 10.5 GPM
- **INLET:** 3/8"
- **OUTLET:** 1/4"
- **MAX. TEMP:** 300°F

NOZZLE NOT INCLUDED

\$80.25 GUK600W-C

SPRAY GUN ASSEMBLIES



GUN

+



LANCE/WAND

+



NOZZLE PROTECTOR

+



NOZZLE

A typical gun assembly includes a gun, wand (or lance), nozzle protector and nozzle.

BAY ACCESSORIES

SPRAY GUNS



KLEEN-RITE GUNS

SPRAY GUNS

KLEEN-RITE.com

- Interchange with CAT 32121 gun parts
- **MAX FLOW:** 10.5 GPM
- **MAX PRESSURE:** 4000PSI
- **MAX TEMP:** 300° F.
- **INLET:** 3/8" FPT
- **OUTLET:** 1/4" FPT

\$28.01	GUK600W	Weep
\$28.01	GUK600NW	Non Weep

REPLACEMENT KITS FOR KLEEN-RITE GUNS

SPRAY GUN REPAIR PARTS

\$13.75	GUK600KW	WEEP (For guns manufactured up to 2007)	\$12.37	GUK600H	Non Weep Housing with screws
\$15.61	GUK600KW-N	WEEP (For guns manufactured 2007 and after)	\$12.37	GUK600HW	WEEP Housing with screws
\$13.14	GUK600K	Repair Kit for GU600NW Non-Weep Gun			



GIANT GUNS

SPRAY GUNS



GIANT
Performance Under Pressure

- **MAX FLOW:** 10 GPM
- **MAX PSI:** 5000 PSI
- **MAX TEMP:** 300° F.
- **REAR INLET:** 3/8" FPT
- **OUTLET:** 1/4" FPT

STAINLESS STEEL

GIANT SPRAY GUNS

BRASS

GIANT SPRAY GUNS

\$33.47	PU21250	Non-Weep - SS Outlet	\$21.22	PU21290	Non-Weep
\$33.47	PU21255	Weep - SS Outlet	\$21.22	PU21295	Weep
\$26.84	PU21260	Non-weep with recessed fitting	\$25.79	PU21495	Weep - Stronger Material - Withstands Impacts
\$26.85	PU21265	Weep with recessed fitting			

REPLACEMENT KITS FOR GIANT GUNS

GIANT SPRAY GUNS

\$5.79	PU21240	Weep
\$5.16	PU21227	Non-Weep



STRAIGHT GRIP SPRAY GUN WITH HORIZONTAL FLOW THROUGH DESIGN

KLEEN-RITE

KLEEN-RITE.com

- Easy pull trigger
- **MAX GPM:** 10.5
- **MAX PSI:** 4000
- **MAX TEMP:** 300° F.
- **INLET:** 3/8" FPT
- **OUTLET:** 1/4" FPT

\$47.95	GUK700NW	NON-WEEP
----------------	-----------------	-----------------



EASY PULL TRIGGER SPRAY GUN

KLEEN-RITE

KLEEN-RITE.com

- Easy pull trigger
- **MAX GPM:** 10.5
- **MAX PSI:** 4000
- **MAX TEMP:** 300° F.
- **INLET:** 3/8" FPT
- **OUTLET:** 1/4" FPT

\$30.67	GUKEZW	WEEP
\$33.48	GUKEZNW	NON-WEEP
\$17.21	GUKEZK	REPAIR KIT



ADJUSTABLE TRIGGER GUN

U. S. PARA PLATE



- UST Trigger Control - Light trigger pull
- Spring loaded positive shutoff
- Forged brass valve housing
- Stainless steel ball/rod with Viton seals
- **MAX GPM:** 10 GPM
- **MAX PSI:** 3000
- **MAX TEMP:** 300° F.
- **INLET:** 3/8" FPT
- **OUTLET:** 1/4" FPT

\$42.10	GUP106	WEEP
\$14.80	GUP251	Nozzle for Weep Gun
\$51.15	GUP106N	NON-WEEP
\$12.57	GUP250	Nozzle for Non-Weep Gun
\$3.25	GUP253	Seal Kit
\$24.86	GUP254	Rod Kit



CAT PUMPS® TRIGGER GUN

CAT PUMPS



- Durable Nylon body with new heat-resistant trigger and anti-fatigue design for longer life, less breakage
- Stainless Steel ball, seat
- **MAX FLOW:** 10.5GPM
- **MAX PSI:** 5000
- **MAX TEMP:** 300° F.
- **INLET:** 3/8" FPT
- **OUTLET:** 1/4" FPT

\$44.10	PU36141	Weep
\$44.10	PU36140	Non-Weep
\$22.50	PU36080	Repair Kit for both guns

ANTI-FATIGUE DESIGN



BAY ACCESSORIES

SPRAY GUNS



MV925 EASY PULL TRIGGER SPRAY GUN

MECLINE

- MAX FLOW: 8.0 GPM
- MAX PRESSURE: 4500 PSI
- MAX TEMP.: 320° F.
- INLET: 3/8" FPT
- OUTLET: 1/4" FPT

\$20.88	MV925	Non-Weep	EASY PULL
\$18.96	MV925-W	Weep	



ECONOMY SPRAY GUN

J.E. ADAMS



- Rear Entry
- MAX TEMP: 320°F
- MATERIAL: Brass
- MAX PSI: 4000
- INLET: 3/8"
- OUTLET: 1/4"

\$31.11	GU6520NW	Non-Weep	8 GPM
\$32.48	GU6520W	Weep	7 GPM



M407 SPRAY GUN

MTM HYDRO



- INLET: 3/8"
- OUTLET: 1/4"
- MAX PSI: 4000
- MAX GPM: 7.0

\$36.62	MTM100001	
NON-WEEP		



SG35 EASY PULL SPRAY GUN

MTM HYDRO



- INLET: 3/8"
- OUTLET: 1/4"
- MAX PSI: 5000
- MAX GPM: 12.0

\$46.45	MTM100342	
NON-WEEP		



SG35 ACID-RESISTANT EASY PULL SPRAY GUN

MTM HYDRO



- INLET: 3/8"
- OUTLET: 1/4"
- MAX PSI: 5000
- MAX GPM: 12.0

\$42.54	MTM100381	
NON-WEEP • ACID RESISTANT		



SUT1100 LIGHT WEIGHT GUNS

SUTTNER



- INLET: 3/8"
- OUTLET: 1/4"
- MAX PSI: 3050
- MAX GPM: 7.0

\$28.01	SUT1100W	Weep
\$23.27	SUT1100NW	Non Weep
\$12.30	SUT1100WK	Repair Kit (Weep)
\$11.45	SUT1100NWK	Repair Kit (Non-Weep)

NON-WEEP



SUT1500 SPRAY GUNS

SUTTNER



- INLET: 3/8"
- OUTLET: 1/4"

\$23.85	SUT1500W	Weep • 4000 PSI @ 12 GPM	\$17.57	SUT1500WK	Repair Kit (Weep)
\$23.85	SUT1500NW	Non Weep • 5000 PSI @ 10.4 GPM	\$9.38	SUT1500NWK	Repair Kit (Non Weep)



SUT1500 OPEN GUN

SUTTNER



- Perfect for Triple Foam applications!
- Ideal when unloader is unavailable
- INLET: 3/8" FPT
- OUTLET: 1/4" FPT
- MAX TEMP: 300° F
- MAX PSI: 4000 PSI

\$15.23	SUT1500H
----------------	-----------------



SUT2605 SPRAY GUN

SUTTNER



- INLET: 3/8" FMPT
- MAX TEMP: 300° F
- OUTLET: 1/4" FMPT
- MAX PSI: 5000
- MAX GPM: 12.0

\$36.91	SUT2600NW
----------------	------------------

RELAX ACTION TRIGGER

SPRAY GUNS



SUT810 SERIES GUNS

SUTTNER



- Inlet & discharge are both in the front of the gun, rather than through the gun body.
- **INLET:** 3/8" • **OUTLET:** 1/4"
- **MAX PSI:** 3050 • **MAX GPM:** 8.0

\$22.84	SUT810W	Weep
\$22.38	SUT810NW	Non Weep
\$11.88	SUT810K	Repair Kit (Weep)

FRONT INLET



SUT2305 SERIES GUNS

SUTTNER



- **MAX PSI:** 4500 (Weep) & 5000 (Non Weep)
- **INLET:** 3/8" • **OUTLET:** 1/4"
- **MAX GPM:** 12.0 • **MAX TEMP:** 300°F

\$30.20	SUT2300W	Weep
\$32.12	SUT2300NW	Non Weep
\$49.26	SUT2300NW-S	Non-Weep With Swivel Inlet
\$12.14	SUT2300KW	Repair Kit

RELAX ACTION - EASY PULL



SUT1200 SERIES BRASS WASH DOWN GUN

SUTTNER



- **HOUSING:** Forged brass
- **INLET:** 1/2" FNPT • **MAX. PSI:** 350
- **MAX. FLOW:** 27 GPM • **MAX. TEMP.:** 190°F

\$65.96	SUT1200
----------------	----------------



SUT1200 SERIES STAINLESS STEEL WASH DOWN GUN

SUTTNER



- **HOUSING:** Stainless Steel
- **INLET:** 1/2" FNPT • **MAX. PSI:** 350
- **MAX. FLOW:** 27 GPM • **MAX. TEMP.:** 190°F

\$138.53	SUT1200SS
-----------------	------------------



SUT601 SERIES GUNS

SUTTNER



- A unique 15° angle designed for extended length lances for higher reach.
- **INLET:** 3/8" • **OUTLET:** 1/4"
- **MAX PSI:** 4000 • **MAX GPM:** 12.0
- Repair kits available!

\$30.23	SUT601NW	Non Weep
\$39.42	SUT601W	Weep
\$23.72	SUT000054	Repair Kit



AA70 SERIES GUNJET SPRAY GUNS

SPRAYING SYSTEMS CO

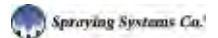

- Brass valve body, with stainless steel parts
- Bottom trigger pivot
- Inlet swivel eliminates hose twisting
- Viton O-rings • **MAX TEMP.:** 300°F
- **MAX FLOW:** 10 GPM • **MAX PSI:** 5000
- **OUTLET:** 1/4" FPT • **REAR INLET:** 3/8" FPT

\$41.78	GUSSAA70	Non Weep
\$41.78	GUSSAA70W	Weep



5030 SERIES SPRAY GUN

J.E. ADAMS SPRAY GUNS



- Brass valve body
- **BRASS INLET:** 3/8" FPT • **MAX TEMP.:** 300°F
- **BRASS OUTLET:** 1/4" FPT • **MAX PRESSURE:** 4500 PSI
- **MAX FLOW:** 12 GPM
- **BRASS INLET:** 3/8" FPT

\$33.41	GU0114	Weep
\$33.60	GU0114-EW	Extra Weep
\$33.19	GU0115	Non Weep

GU0115

REPAIR KITS FOR 5030 SERIES

SPRAY GUN REPAIR PARTS

\$17.07	GU0114K	Weep Repair Kit
\$17.53	GU0114K-EW	Extra Weep Repair Kit
\$14.54	GU0115K	Non Weep Repair Kit



LOOKING FOR MORE SPRAY GUNS?

Visit our website to request our Pressure Wash catalog for an even larger selection of quality products!

BAY ACCESSORIES

DUMP GUNS, FOAM GUNS & ACCESSORIES



12" BARREL STAINLESS STEEL DUMP GUN KLEEN-RITE.com

- KLEEN-RITE
- Dump guns are designed to allow low pressure spray while trigger is released and high pressure when trigger is pulled.
 - **MAX FLOW:** 10 GPM
 - **MAX PSI:** 3000 PSI
 - **INLET:** 3/8" FPT
 - **MAX TEMP.:** 140° F
 - **LANCE HANDLE:** 12"
 - **OUTLET:** 1/8" FPT

\$90.31 GUKD85WL



15" BARREL DUMP GUN

- CAT PUMPS
- Eliminates need for regulator or unloader valve
 - **TOTAL LENGTH:** 25"
 - **INLET:** 3/8" FPT
 - **MAX FLOW:** 10 GPM
 - **OUTLET:** 1/8" FPT
 - **MAX TEMP.:** 140° F
 - **PSI:** 3000

\$107.50	PU32300	Gun
\$27.50	PU32763	Repair Kit



FOAM GUNS & FOAM GUN PARTS

HAMEL MANUFACTURING CO.



STAINLESS STEEL RUBBER COATED

HAMEL MANUFACTURING CO.

\$24.07	GUFBKSS	Black
\$24.07	GUFRSS	Red
\$24.07	GUFBLS	Blue

RUBBER COATED

HAMEL MANUFACTURING CO.

\$18.14	GUFBK	Black
\$18.14	GUFR	Red
\$18.14	GUFB	Blue

NOZZLE PROTECTORS

HAMEL MANUFACTURING CO.

\$2.36	NPHRBK	Black
\$2.36	NPHRR	Red
\$2.36	NPHRBL	Blue

FOAM GUN NOZZLE SPRAYING SYSTEMS CO.

\$6.38 SN5040VVSS2

TRIPLE FOAM HOSE WALL MOUNT HOLDER

BAY ACCESSORIES

- Stainless steel construction
- Attaches your triple foam hose to the wall
- For use with coil hose tubing on a triple foam system
- Eliminates the need for an extra ceiling boom

\$36.00 TFWMHSS

BREAKAWAY FITTINGS FOR ALL GUNS

- Solid brass
- Save your guns from damage when hoses catch on vehicles
- Fitting will break before damage to gun or wand occurs

\$3.73	GU5068	1/4"
\$4.02	GU5069	3/8"

GUN GUARD SPRAY GUN PROTECTOR

- Protect your guns from damage caused by repetitive insertion into the wand holder.

\$7.10 GUG22046

SPRAY GUN FITTINGS

VARIOUS MANUFACTURERS

PRICE	PART #	DESCRIPTION	COMPANY
\$12.57	GUP250	Non-Weep Discharge	PARA PLATE
\$14.80	GUP251	Weep Discharge	PARA PLATE
\$5.52	GU5091D1	Inlet Fitting	J.E. ADAMS
\$6.39	GU5038	Discharge Fitting	J.E. ADAMS
\$4.74	PU21244	Inlet Fitting	GIANT
\$7.82	PU21279	Brass Discharge Fitting	GIANT
\$10.41	PU21256	Stainless Steel Discharge Fitting	GIANT
\$3.69	PU77039	1/4" Discharge Fitting	FAT PUMPS
\$15.00	PU32006	1/4" Discharge Fitting	FAT PUMPS
\$23.03	GUK615	3/8" Inlet Fitting	KLEEN-RITE.com
\$13.60	GUK620	1/4" Outlet Fitting	KLEEN-RITE.com

BAY ACCESSORIES

NOZZLES/SPRAY TIPS

GENERAL PUMP® SPRAY TIPS

GENERAL PUMP



- General Pump High Pressure Spray Tips are built using an innovative design and manufacturing approach that ensures accuracy and provides consistent durability and performance for all types of high pressure cleaning systems.
- View chart below to determine nozzle size

HOW TO DETERMINE NOZZLE SIZE:

- 1 Calculate GPM & PSI to determine nozzle size
(Ex. 1200 PSI at 3.8 GPM = nozzle size of 07)
- 2 After determining nozzle size, choose a degree of spray pattern:
15 = 15° (narrow)
25 = 25° (medium)
40 = 40° (wide)
Available spray patterns : 05, 15, 25, 40, 50, 65, 80
- 3 Degree of spray does not affect nozzle volume

$$\text{GPN} \text{ -- } + \text{ -- } + \text{M} \text{ --}$$

° of nozzle male
spray size fitting size 2 = 1/8
4 = 1/4



ALL TIPS COME WITHOUT VEINS
ALL MEGS ARE HARDENED STAINLESS STEEL
FEMALE NOZZLES AVAILABLE

SOME OF THE MORE POPULAR SIZES INCLUDE:

15°	25°	40°
GPN1505	GPN2505	GPN4005
GPN1506	GPN2506	GPN4006
GPN1507	GPN2507	GPN4007
GPN1508	GPN2508	



QUICK CONNECT SPRAY TIPS

GENERAL PUMP



- Color-coded high pressure sprayer tips
- 5000 PSI operating pressure
- Through-hardened stainless steel orifices
- Resists cracking & wear, Color coded tip protector
 - Red - 0°
 - Green - 25°
 - Yellow - 15°
 - White - 40°

PART # FORMULA

$$\text{QC} \text{ -- } + \text{ --}$$

° of nozzle
spray size

INTERIOR #S ARE GPM

NOZZLE SIZE	ORIFICE DIAM. (INCHES)	40 PSI	100 PSI	250 PSI	500 PSI	600 PSI	700 PSI	800 PSI	1000 PSI	1200 PSI *	1500 PSI	2000 PSI	2500 PSI	3000 PSI	3500 PSI	4000 PSI
2	.034	.20	.32	.50	.71	.77	.80	.89	1.0	1.1	1.2	1.4	1.6	1.7	1.9	2.0
4	.052	.40	.63	1.00	1.40	1.60	1.70	1.80	2.0	2.2	2.5	2.8	3.1	3.5	3.8	4.0
4.5	.055	.45	.71	1.10	1.50	1.70	1.90	2.00	2.2	2.4	2.8	3.0	3.6	3.9	4.3	4.5
5	.057	.50	.79	1.30	1.80	1.90	2.10	2.20	2.5	2.8	3.1	3.6	4.0	4.4	4.7	5.0
5.5	.060	.55	.87	1.40	1.90	2.10	2.30	2.50	2.8	3.0	3.4	3.8	4.4	4.8	5.2	5.5
6	.062	.60	.95	1.50	2.10	2.30	2.50	2.70	3.0	3.2	3.7	4.2	4.8	5.2	5.6	6.0
6.5	.064	.65	1.00	1.70	2.30	2.50	2.70	2.90	3.3	3.6	4.0	4.6	5.2	5.7	6.0	6.5
7 *	.067	.70	1.10	1.80	2.50	2.70	2.90	3.10	3.5	3.8*	4.3	5.0	5.6	6.1	6.6	7.0
7.5	.070	.75	1.20	1.90	2.70	2.90	3.20	3.40	3.8	4.1	4.6	5.3	6.0	6.5	7.0	7.5
8	.072	.80	1.30	2.00	2.80	3.10	3.40	3.60	4.0	4.4	5.0	5.6	6.2	7.0	7.5	8.0
8.5	.074	.85	1.30	2.20	3.00	3.30	3.60	3.80	4.3	4.6	5.3	6.0	6.7	7.4	8.0	8.5
9	.076	.90	1.40	2.30	3.20	3.50	3.80	4.00	4.8	5.0	5.5	6.4	7.1	7.8	8.5	9.0
9.5	.078	.95	1.50	2.40	3.40	3.70	4.00	4.30	4.8	5.2	5.8	6.8	7.6	8.3	9.0	9.5
10	.080	1.00	1.60	2.50	3.50	3.90	4.20	4.50	5.0	5.4	6.1	7.0	8.0	8.7	9.4	10.0



AUTOMATIC NOZZLE REPLACEMENT KITS

GENERAL PUMPS

- Nozzle replacement kits for popular brand automatic car washes

\$62.44	GPN105140	PDQ Laser 4000	\$47.23	GPN105145	D&S 5000 Blaster
\$60.23	GPN105144	D&S 5000 Gantry	\$90.97	GPN105154	SSA Futura

DRAIN CLEANING NOZZLES

GENERAL PUMPS



- Self-propelled drain cleaning nozzle lets you unclog drain lines inexpensively. Hook up to high pressure hose to blast through clogs.

\$16.40	GPNYDRNT1	1/4" Male Brass
\$24.82	GPNYDRNT2	1/4" Male Stainless Steel
\$33.73	GPNYDRNT3	3/8" Male Stainless Steel



TIP TWISTER®

HAMEL MANUFACTURING CO.



Hamel Manufacturing Co.

\$8.56	SNTTM4	5/8 Twister - Fits 1/4" Nozzle
\$9.92	SNTTM2	1/2 Twister - Fits 1/8" Nozzle

BAY ACCESSORIES

SPRAY NOZZLES



WASHJET® MEG SPRAY NOZZLES SPRAYING SYSTEMS CO.

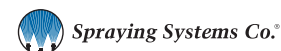

- Spray angles of 0° to 65°
- Uniform distribution – an internal guide vane stabilizes liquid turbulence
- Longer wear life and flow control accuracy with specially hardened stainless steel
- Female nozzles and VeeJet® nozzles are available

\$4.54	SN6502M4	1/4"
\$4.35	SN1515M2	1/8" Male NPT

HOW TO DETERMINE NOZZLE SIZE:

- Calculate GPM & PSI to determine nozzle size (Ex. 1200 PSI at 3.8 GPM = nozzle size of 07 See * below)
- After determining nozzle size, choose a degree of spray pattern:
 - 15 = 15° (narrow)
 - 25 = 25° (medium)
 - 40 = 40° (wide)
- Available spray patterns : 05, 15, 25, 40, 50, 65, 80
- Degree of spray does not affect nozzle volume

THE PERFECT CAR WASH NOZZLE SPRAY NOZZLES



- 32° Available in these sizes only!!

\$4.34	SN3205M2
\$4.35	SN3206M2
\$4.35	SN3207M2

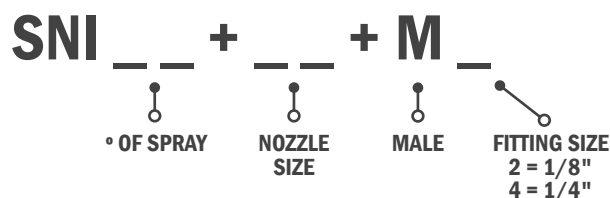

INTERIOR #S ARE GPM

NOZZLE SIZE	ORIFICE DIAM. (INCHES)	40 PSI	100 PSI	250 PSI	500 PSI	600 PSI	700 PSI	800 PSI	1000 PSI	1200 PSI *	1500 PSI	2000 PSI	2500 PSI	3000 PSI	3500 PSI	4000 PSI
2	.034	.20	.32	.50	.71	.77	.80	.89	1.0	1.1	1.2	1.4	1.6	1.7	1.9	2.0
4	.052	.40	.63	1.00	1.40	1.60	1.70	1.80	2.0	2.2	2.4	2.8	3.2	3.5	3.8	4.0
4.5	.055	.45	.71	1.10	1.60	1.70	1.90	2.00	2.3	2.4	2.8	3.2	3.6	3.9	4.3	4.5
5	.057	.50	.79	1.30	1.80	1.90	2.10	2.20	2.5	2.8	3.1	3.5	4.0	4.3	4.7	5.0
5.5	.060	.55	.87	1.40	1.90	2.10	2.30	2.50	2.8	3.0	3.4	3.9	4.3	4.8	5.2	5.5
6	.062	.60	.95	1.50	2.10	2.30	2.50	2.70	3.0	3.2	3.7	4.2	4.7	5.2	5.6	6.0
6.5	.064	.65	1.00	1.70	2.30	2.50	2.70	2.90	3.3	3.6	4.0	4.6	5.1	5.6	6.0	6.5
7 *	.067	.70	1.10	1.80	2.50	2.70	2.90	3.10	3.5	3.8*	4.3	4.9	5.6	6.1	6.6	7.0
7.5	.070	.75	1.20	1.90	2.70	2.90	3.20	3.40	3.8	4.1	4.6	5.3	5.9	6.5	7.0	7.5
8	.072	.80	1.30	2.00	2.80	3.10	3.40	3.60	4.0	4.4	4.9	5.7	6.3	6.9	7.5	8.0
8.5	.074	.85	1.30	2.20	3.00	3.30	3.60	3.80	4.3	4.6	5.2	6.0	6.7	7.4	8.0	8.5
9	.076	.90	1.40	2.30	3.20	3.50	3.80	4.00	4.5	5.0	5.5	6.4	7.1	7.8	8.5	9.0
9.5	.078	.95	1.50	2.40	3.40	3.70	4.00	4.30	4.8	5.2	5.8	6.7	7.5	8.2	9.0	9.5
10	.080	1.00	1.60	2.50	3.50	3.90	4.20	4.50	5.0	5.4	6.1	7.1	7.9	8.7	9.4	10.0



WASHJET® IMEG® SPRAY NOZZLES SPRAYING SYSTEMS CO.



- Patented design provides optimized fluid dynamics to minimize turbulence and maximize spray performance
- The 302 stainless steel guide vane further stabilizes turbulent flow and improves pattern quality and cleaning efficiency
- Spray angles of 0° to 65°
- Uniform distribution – an internal guide vane stabilizes liquid turbulence
- Longer wear life and flow control accuracy with specially hardened stainless steel
- Please reference nozzle # chart above for help!

BAY ACCESSORIES

NOZZLES/SPRAY TIPS

SPRAYING SYSTEMS CO.® STAINLESS & KYNAR® TIPS

SPRAYING SYSTEMS CO

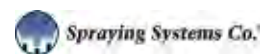

PRICE	KR PART #	SPRAYING SYSTEMS #	MATERIAL	ANGLE	NOZZLE #	GPM @40 PSI
\$7.60	SN0004USS4	H1/4U-SS0004	Stainless Steel	0°	04	.40
\$7.60	SN0005USS4	H1/4U-SS0005		0°	05	.50
\$7.07	SN1502VVSS4	H1/4VV-SS1502		15°	02	.20
\$7.60	SN1510USS4	H1/4U-SS1510			10	1.02
\$7.57	SN1515USS4	H1/4U-SS1515			15	1.54
\$7.57	SN1520USS4	H1/4U-SS1520			20	2
\$7.57	SN1530USS4	H1/4U-SS1530			30	3
\$7.07	SN1503VVSS4	H1/4VV-SS1503			03	.30
\$7.07	SN1505VVSS4	H1/4VV-SS1505			05	.50
\$7.07	SN1506VVSS4	H1/4VV-SS1506			06	.60
\$7.07	SN1508VVSS4	H1/4VV-SS1508		08	.80	
\$7.07	SN2505VVSS4	H1/4VV-SS2505		25°	05	.50



\$2.41	SNCCP2501M4	H1/4VV-CKY2501	Kynar/Green	25°	01	.10
\$2.41	SNCCP2502M4	H1/4VV-CKY2502			02	.20
\$2.41	SNCCP2503M4	H1/4VV-CKY2503			03	.30
\$2.41	SNCCP2506M4	H1/4VV-CKY2506			06	.60
\$2.41	SNCCP2506M4	H1/4VV-CKY2508			08	.80
\$2.41	SNCCP2510M4	H1/4VV-CKY2510			10	1
\$2.42	SN2515CKY4	H1/4U-CKY2515			15	1.50
\$2.42	SN2520CKY4	H1/4U-CKY2520			20	2
\$2.33	SN2530CKY4	H1/4U-CKY2530			30	3



\$2.41	SNCCP4002M4	H1/4VV-CKY4002	Kynar/White	40°	02	.20
\$2.41	SNCCP4003M4	H1/4VV-CKY4003			03	.30
\$2.41	SNCCP4004M4	H1/4VV-CKY4004			04	.40
\$2.41	SNCCP4005M4	H1/4VV-CKY4005			05	.50
\$2.41	SNCCP4006M4	H1/4VV-CKY4006			06	.60
\$2.41	SNCCP4008M4	H1/4VV-CKY4008			08	.80
\$2.41	SNCCP4010M4	H1/4VV-CKY4010			10	1
\$2.42	SN4015CKY4	H1/4U-CKY4015			15	1.50
\$2.42	SN4020CKY4	H1/4U-CKY4020			20	2
\$2.42	SN4030CKY4	H1/4U-CKY4030			30	3



\$2.41	SNCCP6501M4	H1/4VV-CKY6501	Kynar/Purple	65°	01	.10
\$2.41	SNCCP6502M4	H1/4VV-CKY6502			02	.20
\$2.41	SNCCP6503M4	H1/4VV-CKY6503			03	.30
\$2.41	SNCCP6504M4	H1/4VV-CKY6504			04	.40
\$2.41	SNCCP6505M4	H1/4VV-CKY6505			05	.50
\$2.41	SNCCP6506M4	H1/4VV-CKY6506			06	.60
\$2.41	SNCCP6508M4	H1/4VV-CKY6508			08	.80
\$2.41	SNCCP6510M4	H1/4VV-CKY6510			10	1
\$2.42	SN6515CKY4	H1/4U-CKY6515			15	1.50
\$2.42	SN6520CKY4	H1/4U-CKY6520			20	2
\$2.42	SN6530CKY4	H1/4U-CKY6530			30	3
\$2.42	SN6550CKY4	H1/4U-CKY6550			50	5



\$2.41	SNCCP8001M4	H1/4VV-CKY8001	Kynar/Light Green	80°	01	.10
\$2.41	SNCCP8002M4	H1/4VV-CKY8002			02	.20
\$2.41	SNCCP8003M4	H1/4VV-CKY8003			03	.30
\$2.41	SNCCP8004M4	H1/4VV-CKY8004			04	.40
\$2.41	SNCCP8005M4	H1/4VV-CKY8005			05	.50
\$2.41	SNCCP8006M4	H1/4VV-CKY8006			06	.60
\$2.41	SNCCP8008M4	H1/4VV-CKY8008			08	.80
\$2.41	SNCCP8010M4	H1/4VV-CKY8010			10	1
\$2.42	SN8015CKY4	H1/4U-CKY8015			15	1.50
\$2.42	SN8020CKY4	H1/4U-CKY8020			20	2
\$2.42	SN8030CKY4	H1/4U-CKY8030			30	3

BAY ACCESSORIES

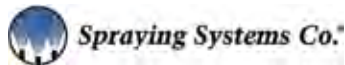

NOZZLES/SPRAY TIPS



FLOODJET® WIDE ANGLE FLAT SPRAY TIP

SPRAYING SYSTEMS CO.

PRICE	PART #	ORIFICE	COLOR	PRICE	PART #	ORIFICE	COLOR
\$1.03	SNTKVP3	3.0	Gray	\$0.99	SNTKVP7.5	7.5	Green
\$0.99	SNTKVP4	4.0	White	\$0.99	SNTKVP10	10.0	Black
\$1.03	SNTKVP5	5.0	Blue				

FLOODJET® SPRAY TIPS

SPRAYING SYSTEMS CO.

STAINLESS STEEL			BRASS			PVC		
\$11.05	SNFJ02K18SS	1/8" FLOODJET #18 NOZZLE	\$3.75	SNFJ02K3	1/8" FLOODJET #3 NOZZLE	\$16.73	SNFJ04K15PVC	1/4" FLOODJET #15 NOZZLE
\$11.05	SNFJ02K7.5SS	1/8" FLOODJET #7.5 NOZZLE	\$3.75	SNFJ02K7.5	1/8" FLOODJET #7.5 NOZZLE	\$16.73	SNFJ04K27PVC	1/4" FLOODJET #27 NOZZLE
\$13.36	SNFJ04K10SS	1/4" FLOODJET #10 NOZZLE	\$5.93	SNFJ045	1/4" FLOODJET #5 NOZZLE	\$16.73	SNFJ04K75PVC	1/4" FLOODJET #7.5 NOZZLE
\$13.36	SNFJ04K15SS	1/4" FLOODJET #15 NOZZLE	\$5.93	SNFJ0475	1/4" FLOODJET #7.5 NOZZLE			
\$13.36	SNFJ04SS2	1/4" FLOODJET #2 NOZZLE	\$5.93	SNFJ04K10	1/4" FLOODJET #10 NOZZLE			
\$13.36	SNFJ04SS3	1/4" FLOODJET #3 NOZZLE	\$5.93	SNFJ04K15	1/4" FLOODJET #15 NOZZLE			
\$13.36	SNFJ04SS5	1/4" FLOODJET #5 NOZZLE	\$5.93	SNFJ04K3	1/4" FLOODJET #3 NOZZLE			
\$13.36	SNFJ04SS75	1/4" FLOODJET #7.5 NOZZLE						



FOAMJET® NOZZLES

SPRAYING SYSTEMS CO.

- Produces low pressure foam when used with detergent

PLASTIC FOAMJET® NOZZLES

SPRAYING SYSTEMS CO.

- Constructed of lightweight, chemically inserted polypropylene and feature color-coded orifice inserts



*COLOR CODED NOZZLE ORIFICES ON PLASTIC NOZZLES ONLY!

● 02 ● 03 ● 04 ● 05

PRICE	PART #	BODY	DEGREE	ORIFICE	PRICE	PART #	BODY	DEGREE	ORIFICE
\$22.50	SNFJP2002CE	Plastic	20	02	\$22.50	SNFJP6503CE	Plastic	65	03
\$22.50	SNFJP2003CE	Plastic	20	03	\$22.50	SNFJP6505CE	Plastic	65	05
\$22.50	SNFJP2004CE	Plastic	20	04	\$21.24	SNFJP6508CE	Plastic	65	08
\$22.50	SNFJP2005CE	Plastic	20	05	\$22.50	SNFJP8003CE	Plastic	80	03
\$22.50	SNFJP4002CE	Plastic	40	02	\$22.50	SNFJP8004CE	Plastic	80	04
\$22.50	SNFJP4004CE	Plastic	40	04	\$22.50	SNFJP8005CE	Plastic	80	05
\$22.50	SNFJP4005CE	Plastic	40	05					

BRASS FOAMJET® NOZZLES

SPRAYING SYSTEMS CO.



PRICE	PART #	BODY	PATTERN	ORIFICE
\$36.69	SNFJ4003	Brass	40	03
\$36.69	SNFJ8003	Brass	80	03
\$36.69	SNFJ8005	Brass	80	05

STAINLESS STEEL MEF FOAMJET® NOZZLES

1/4" MALE THREADED END

SPRAYING SYSTEMS CO.



PRICE	PART #	BODY	PATTERN	ORIFICE
\$57.95	SNFJ4005SS4	SS	40	05
\$57.95	SNFJ4006SS4	SS	40	06
\$57.95	SNFJ4007SS4	SS	40	07
\$57.95	SNFJ4008SS4	SS	40	08
\$57.95	SNFJ4010SS4	SS	40	10

QUICKJET® FOAMJET®

SPRAYING SYSTEMS CO.

- QJFP offers easy installation and maintenance with quarter-turn automatic alignment
- Offers a complete array of spray patterns and angles
- Plastic spray tips are constructed of lightweight, chemically inserted CELCON® and feature color-coded orifice inserts



PRICE	PART #	BODY	DEGREE	ORIFICE	PRICE	PART #	BODY	DEGREE	ORIFICE
\$18.37	SNQJFJP4002	Plastic	40	02	\$18.37	SNQJFJP8003	Plastic	80	03
\$18.37	SNQJFJP4005	Plastic	40	05	\$18.37	SNQJFJP8004	Plastic	80	04
\$18.37	SNQJFJP8002	Plastic	80	02	\$18.37	SNQJFJP8008	Plastic	80	08

NOZZLES/SPRAY TIPS & STRAINERS

UNIJET® ASSEMBLY



BODY

STRAINER

NOZZLE

CAP



NOZZLE BODY

SPRAYING SYSTEMS CO.

- Bodies have male thread for TeeJet® caps & fit various pipe thread sizes listed below.

PRICE	PART #	MATERIAL	THREAD
\$2.32	SNCP1322	Brass	1/4" M
\$2.32	SNCP1321	Brass	1/4" F x M
\$2.32	SNCP1336	Brass	1/8" M
\$1.52	SNCP12094	Nylon	1/4" F
\$1.54	SNCP8028	Nylon	1/4" M
\$10.98	SNCP1322SS	Stainless Steel	1/4" M
\$10.96	SNCP1321SS	Stainless Steel	1/4" M x F
\$10.96	SNCP1336SS	Stainless Steel	1/8" M

UNIJET® FLAT FAN SPRAY NOZZLES

SPRAYING SYSTEMS CO.®

- For Rinse or Soap arches. Designed to be used with the bodies, caps and strainers shown on this page.
- OTHER SIZES AVAILABLE



PART #	MATERIAL	ORIFICE	PATTERN
SNTP1504	Brass	4	15°
SNTP1506	Brass	6	15°
SNTP1508	Brass	8	15°
SNTP2504	Brass	4	25°
SNTP2506	Brass	6	25°
SNTP2509	Brass	9	25°
SNTP4003	Brass	3	40°
SNTP4004	Brass	4	40°
SNTP4005	Brass	5	40°
SNTP4006	Brass	6	40°
SNTP4008	Brass	8	40°
SNTP4010	Brass	10	40°
SNTP4020	Brass	20	40°

\$2.76

BRASS ADJUSTABLE BALL FITTING

SPRAYING SYSTEMS CO.

- 1/4" M x 1/4" F with 1" hex and 45° angle of adjustment



\$13.63 SN36275-44

TEEJET® FITTING ADAPTER

SPRAYING SYSTEMS CO.

- Replaces spray tips and are used for attaching drop pipes to nozzle bodies or adding extensions to GunJet Spray guns and trigger valves
- Brass • 1" • 1/8" NPT Female Outlet



\$6.40 SNCP4928

METERING PLATES

SPRAYING SYSTEMS CO.

PRICE	PART #	#	MATERIAL
\$2.10	SNCP4916-39	39	Stainless



STRAINERS

SPRAYING SYSTEMS CO.

- With Stainless Steel, Brass, or Poly Screens

PRICE	PART #	MESH	MATERIAL
\$1.01	SNCP8079PP24	24	Poly
\$1.01	SNCP8079PP50	50	Poly
\$1.01	SNCP8079PP100	100	Poly
\$1.01	SNCP8079PP200	200	Poly
\$2.30	SNTJ505350	50	Brass
\$2.30	SNTJ5053100	100	Brass



STRAINERS WITH CHECK VALVE

SPRAYING SYSTEMS CO.

- With Stainless Steel Screens

PRICE	PART #	MESH	MATERIAL
\$3.35	SNTJ4193APP205	50	Stainless
\$3.22	SNTJ4193PP2080	80	Stainless
\$3.23	SNTJ4193PP524	24	Stainless
\$3.23	SNTJ4193PP550	50	Stainless
\$16.49	SNTJ4193SS1050	50	Stainless
\$16.49	SNTJ4193SS201	100	Stainless
\$16.49	SNTJ4193SS550	50	Stainless



WING CAP

NOZZLE CAPS

SPRAYING SYSTEMS CO.

PRICE	PART #	MATERIAL	STYLE
\$1.36	SNCP1325	Brass	Hex
\$0.86	SNCP8027	Nylon	Standard
\$5.95	SNCP1325SS	Stainless	Hex
\$1.24	SNCP18032A-NYB	Nylon	Winged

STANDARD CAP

BAY ACCESSORIES

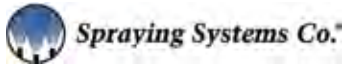

SPRAY ARCH ASSEMBLIES & MORE

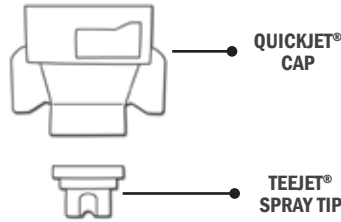
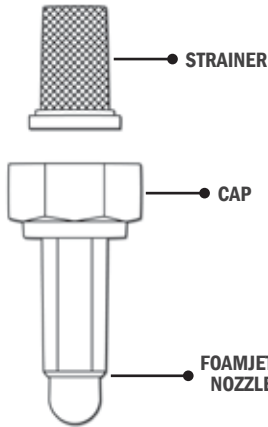

SPRAY ARCH ASSEMBLIES

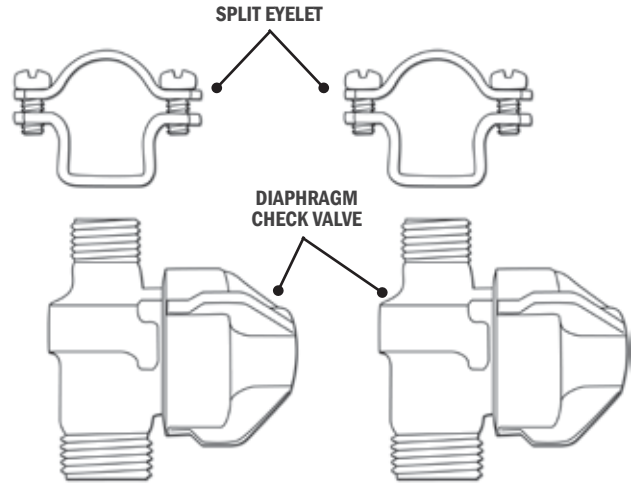

QUICK RELEASE CHECK VALVE



QUICKJET® CAPS SPRAYING SYSTEMS CO.

- Easily preassemble Tips, Caps, Check Valves & Seat Gaskets. For use with flat TeeJet Nozzles. 1/4" F

\$5.98 SNQJ8360QR



CAP & GASKET SPRAYING SYSTEMS CO.

\$0.97 SNCP25610

SPRAY TIP SPRAYING SYSTEMS CO.



SPLIT EYELET BODY SPRAYING SYSTEMS CO.

- More types and sizes available
- Easiest & fastest way to mount spray nozzles to a boom. To install nozzles, drill hole, insert split-eyelet inlet & clamp assembly in place. Leak-proof gasket connection.

\$3.95 SETJ742108 1/2" Nylon
SETJ742112 3/4" Nylon



EPDM DIAPHRAGM SPRAYING SYSTEMS CO.

- Black

\$0.37 SNCP21953EPR



VITON DIAPHRAGM SPRAYING SYSTEMS CO.

- Brown

\$1.46 SNCP21953VI



UNIJET® ADAPTER SPRAYING SYSTEMS CO.

- Permits use of standard 1/4" MPT nozzles with QuickJet® assemblies. Made of Celcon with EPDM seat gasket.

\$2.52 SNQJ4676



REGULAR PIPE THREAD STYLE SPRAYING SYSTEMS CO.

- Easy to install
- 1/4" F Thread
- 1/4" stainless steel

\$6.22 SE75210804 1/2"
SE7521124ZB 3/4"



"DRIP FREE" DIAPHRAGM CHECK VALVE SPRAYING SYSTEMS CO.

- Ideal choice for chemical or soap arches

REGULAR CHECK VALVE SPRAYING SYSTEMS CO.

- 1/4" NPT

\$10.70 SNQJ8360NYB

1/4" FEMALE ADAPTER SPRAYING SYSTEMS CO.

\$1.65 SNTJ4676NYB

BAY ACCESSORIES

SPRAY ARCH ASSEMBLIES & TURBO NOZZLES



PROMAX® CLIP-EYELET NOZZLES

NOZZLES

- Combines a "snap-on" pipe connection with easy-to-install and replace spray tips for versatility
- Adjustable, swivel-type ball makes fast work of changing the direction of the spray without disturbing the pipe connection. It fits 1" pipes with 9/16" holes
- Spray lignment can be finely tuned to minimize overspray
- Flat spray tips are automatically locked into alignment each and every time
- Nozzle is well suited for spraying phosphates, acids, solvents, and other caustics, making it ideal for cleaning, rinsing, conversion coating, and wetting applications
- **MAX PRESSURE:** 60 PSI • **MAX TEMP.:** 180° F.

\$11.17 SN46500A-1-PP

USED
WITH
BOTH



1/4" THREADED BALL

NOZZLES

- The threaded ball accepts a wide variety of conventional spray nozzles. For use with ProMax Clip-Eyelet nozzle & Adjustable Ball Type Nozzle Body

\$2.54 SNCP20582



1/4" ADJUSTABLE BALL TYPE NOZZLE BODY

NOZZLES

- Threaded pipe connection - quick, convenient positioning of the spray tip for accurate spray alignment and reduced overspray
- Easily removed for cleaning and replacement while color coding speeds changeout
- Retaining cap holds the tip in position, even when the nozzle is jarred or vibrated
- **BODY:** Polypropylene • **CAP:** Polyphthalamide • **O-RING:** EPDM • **MAX PSI:** 125 • **MAX TEMP.:** 180° F.

\$7.86 SNAB37235

New!



TURBO LASER ROTOR NOZZLE

GIANT NOZZLES

- **MAX PSI:** 4500 • **MAX. TEMP.:** 195° F • **INLET:** 1/4" FBSP
- **MAX FLOW:** 8.0 GPM • **SPRAY ANGLE:** 20° • **HOUSING:** Brass • **ROTOR:** Ceramic bearing and rotor nozzle

PRICE	ITEM #	SIZE
\$83.48	PU23900-4.5	4.5
\$83.48	PU23900-5.5	5.5

GIANT
Performance Under Pressure



TURBO LASER NOZZLE

GIANT NOZZLES

- **MAX. CONT. PSI:** 3200 • **MAX. PSI:** 3600 • **MAX. TEMP.:** 195° F • **INLET:** 1/4" BSP-F
- **STREAM:** 0° • **SPRAY PATTERN:** 20° • **HOUSING:** Brass • **ROTOR:** Ceramic

PRICE	ITEM #	SIZE
\$50.76	PU23800-30C	3.0
\$50.76	PU23800-35C	3.5
\$50.76	PU23800-40C	4.0
\$50.76	PU23800-45C	4.5

PRICE	ITEM #	SIZE
\$50.76	PU23800-50C	5.0
\$50.76	PU23800-55C	5.5
\$50.76	PU23800-60C	6.0

GIANT
Performance Under Pressure

BAY ACCESSORIES

TURBO NOZZLES

TURBO LASER NOZZLE WITH 2 PIECE PLASTIC NOZZLE COVER

GIANT NOZZLES



- MAX. PSI: 5800
- MAX. TEMP: 195°F
- INLET: 1/4" BSP-F
- MAX. FLOW: 18.7 GPM
- STREAM: 0°
- SPRAY PATTERN: 20°
- NOZZLE: Brass
- ROTOR: Ceramic

PRICE	ITEM #	SIZE
\$88.81	PU22060-20	2.0
\$88.81	PU22060-30	3.0
\$88.81	PU22060-35	3.5
\$88.81	PU22060-40	4.0
\$88.81	PU22060-50	5.0

PRICE	ITEM #	SIZE
\$88.81	PU22060-55	5.5
\$88.81	PU22060-70	7.0
\$88.81	PU22060-80	8.0
\$88.81	PU22060-120	12.0

TURBO LASER NOZZLE

GIANT NOZZLES



- MAX. PSI: 3600
- MAX. TEMP: 195°F
- INLET: 1/4" BSP-F
- MAX. FLOW: 18.5 GPM
- STREAM: 0°
- SPRAY PATTERN: 20°
- NOZZLE: Brass
- ROTOR: Ceramic

PRICE	ITEM #	SIZE
\$55.83	PU22040-20	2.0
\$55.83	PU22040-30	3.0
\$55.83	PU22040-35	3.5
\$55.83	PU22040-40	4.0
\$55.83	PU22040-50	5.0
\$55.83	PU22040-55	5.5

PRICE	ITEM #	SIZE
\$55.83	PU22040-60	6.0
\$55.83	PU22040-70	7.0
\$55.83	PU22040-80	8.0
\$55.83	PU22040-85	8.5
\$55.83	PU22040-10	10.0

TURBO & HIGH IMPACT NOZZLES

TURBO NOZZLES

AR NORTH AMERICA



- It delivers great rotating action that moves high pressure water in a circle, allowing you to clean a much larger area than with a non-rotating model. It has a dark green tip for easy identification at a glance.
- INLET: 1/4" • MAX. PRESSURE: 3700 PSI • MAX. TEMP.: 195°F

PRICE	PART #	SIZE	ID COLOR
\$47.12	ARTPR2530	4.0	Dark Green
\$47.12	ARTPR2550	6.0	Purple

PRICE	PART #	SIZE	ID COLOR
\$47.12	ARTPR2570	7.0	Gray

357, 456 & 457 TURBO NOZZLES

SUTTNER



PRICE	ITEM #	GPM	PSI
\$59.93	SUT357-3	3.0	3625
\$59.93	SUT357-4	4	3625
\$59.93	SUT357-4.5	4.5	3625
\$59.93	SUT357-5	5.0	3625
\$59.93	SUT357-5.5	5.5	3625
\$65.18	SUT357-9	9.0	3625
\$65.18	SUT357-10	10.0	3625
\$108.01	SUT457-4.5	4.5	6000
\$108.01	SUT457-7	7	6000
\$108.01	SUT457-8	8	6000

PRICE	ITEM #	GPM	PSI
\$78.07	SUT456-3.0	3.0	5070
\$78.07	SUT456-3.5	3.5	5070
\$78.07	SUT456-4.0	4.0	5070
\$78.07	SUT456-4.5	4.5	5070
\$78.07	SUT456-5.0	5.0	5070
\$78.07	SUT456-5.5	5.5	5070
\$78.07	SUT456-6.0	6.0	5070
\$78.07	SUT456-7.0	7.0	5070
\$78.07	SUT456-8.0	8.0	5070

WASHJET® NOZZLES

SPRAYING SYSTEMS CO

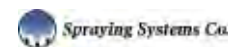

- For high-pressure applications, WashJet nozzles provide superior, high-impact performance
- Uniform distribution by using internal guide vane to stabilize liquid turbulence
- Quick visual reference for spray alignment with milled side flats
- Longer wear life and flow control accuracy with especially hardened stainless steel construction.
- 23990 – Additional exterior protection provided by a nylon outer covering

PRICE	ITEM #	ORIFICE	SIZE
\$26.47	SN23990M4-020	2.0	1/4"
\$26.47	SN23990M4-035	3.5	1/4"

PRICE	ITEM #	ORIFICE	SIZE
\$26.47	SN23990M4-045	4.5	1/4"
\$26.47	SN23990M4-055	5.5	1/4"

BAY ACCESSORIES



NOZZLES

AQUA-ROCKET™ INDUSTRIAL TURBO NOZZLES

HYDRA-FLEX NOZZLES

- DESIGNED SPECIFICALLY FOR INDUSTRIAL CLEANING APPLICATIONS SUCH AS PIT CLEANING, WALL CLEANING, AND PRESSURE WASHING
- MAX. INLET PRESSURE: 5,000 PSI
- MAX. TEMP.: 212°F (100°C)
- HOUSING MATERIAL: Stainless steel
- FLOW RATE: 3.0 GPM to 5.00 GPM
- NOZZLE MATERIAL: Tungsten Carbide



PRICE	PART #	NOZZLE	GPM	REPAIR KIT
\$240.00	HFN2402-030	3.0	3.0	HFN2402-030K
\$240.00	HFN2402-035	3.5	3.5	HFN2402-035K
\$240.00	HFN2402-040	4.0	4.0	HFN2402-040K
\$240.00	HFN2402-045	4.5	4.5	HFN2402-045K
\$240.00	HFN2402-050	5.0	5.0	HFN2402-050K

FLOW RATE BASED ON 4,000 PSI

BLAST-FORCE™ NOZZLES

HYDRA-FLEX NOZZLES

- DESIGNED SPECIFICALLY FOR PIVOTING, OSCILLATING, OR SPINNING HIGH-PRESSURE APPLICATIONS.
- MAX. INLET PRESSURE: 1,000 PSI
- MAX. TEMP.: +180°F (+82°C)
- HOUSING MATERIAL: Stainless Steel
- FLOW RATE: 0.50 GPM to 6.00 GPM
- WEIGHT: 0.27 lbs..
- NOZZLE MATERIAL: Tungsten Carbide



STAINLESS STEEL HIGH PRESSURE NOZZLES

HYDRA-FLEX BLAST-FORCE NOZZLES

FLOW RATE BASED ON 1,000 PSI

PRICE	PART #	NOZZLE	GPM	REPLACEMENT PILL
\$77.70	BFN2010	1.0	.50	BFN1010
\$77.70	BFN2020	2.0	1.00	BFN1020
\$77.70	BFN2030	3.0	1.50	BFN1030
\$77.70	BFN2040	4.0	2.00	BFN1040
\$77.70	BFN2050	5.0	2.50	BFN1050
\$77.70	BFN2060	6.0	3.00	BFN1060
\$60.43	BFN2080	8.0	4.00	BFN1080
\$60.43	BFN2100	10.0	5.00	BFN1100
\$21.20	BFN2120	12.0	6.00	BFN1120

ADAPTERS

HYDRA-FLEX BLAST-FORCE NOZZLES

\$14.20	BFA213-124	3/4" - 16 - 37° JIC x 1/4" MNPT (Straight, Brass)
\$63.00	BFN0670	1/4" MNPT x 1/4" FNPT (Elbow)

BLAST-TEC PRO™ ROTATING NOZZLES

HYDRA-FLEX NOZZLES

- DESIGNED SPECIFICALLY FOR HIGH-PRESSURE, HIGH-IMPACT VEHICLE WASH APPLICATIONS INCLUDING WHEEL BLASTERS, UNDERCARRIAGE, RINSING & HIGH-PRESSURE CLEANING
- MAX. INLET PRESSURE: 1,000 PSI
- MAX. TEMP.: +120°F (+49°C)
- HOUSING MATERIAL: Stainless Steel
- FLOW RATE: 1.0 GPM to 3.0 GPM
- WEIGHT: 0.5 lbs..
- NOZZLE MATERIAL: Tungsten Carbide



324 SERIES - 24° ANGLE

HYDRA-FLEX BLAST-TEC PRO ROTATING NOZZLES

FLOW RATE BASED ON 1,000 PSI

PRICE	NOZZLE	GPM	1/4" BSPP INLET	1/4" NPT INLET
\$115.70	2.0	1.00	BTN1106	BTN1106
\$115.70	3.0	1.50	BTN1107	BTN1601
\$115.70	3.5	1.75	BTN1108	BTN1602
\$115.70	4.0	2.00	BTN1109	BTN1603
\$115.70	4.5	2.25	BTN1110	BTN1604
\$115.70	5.0	2.50	BTN1111	BTN1605
\$115.70	5.5	2.75	BTN1112	BTN1606
\$115.70	6.0	3.00	BTN1113	BTN1607

RETROFIT KITS

\$2,850.50	BTN1394	Blast-Tec Retro Fit Kit for Water Wizard
\$769.60	BTN1441	Blast-Tec Retrofit Kit for Sonny's Omni Pivoting Blaster

ADAPTERS

\$11.10	BTN0572	1/4" BSPP x 1/4" MNPT
---------	---------	-----------------------

430 SERIES - 30° ANGLE

HYDRA-FLEX BLAST-TEC PRO ROTATING NOZZLES

FLOW RATE BASED ON 1,000 PSI

PRICE	NOZZLE	GPM	1/4" BSPP INLET	1/4" NPT INLET
\$128.70	2.0	1.00	BTN1631	BTN1620
\$128.70	3.0	1.50	BTN1632	BTN1621
\$128.70	3.5	1.75	BTN1633	BTN1622
\$128.70	4.0	2.00	BTN1634	BTN1623
\$128.70	4.5	2.25	BTN1634	BTN1624
\$128.70	5.0	2.50	BTN1636	BTN1625
\$128.70	5.5	2.75	BTN1637	BTN1626
\$128.70	6.0	3.00	BTN1637	BTN1627

ADAPTERS

\$49.60	BTN1755	1/4" BSPP x 1/4" NPT Knuckle Ball Joint
\$11.10	BTN0572	1/4" BSPP x 1/4" MNPT
\$11.10	BTN0581	1/4" BSPP x 1/8" NPT
\$9.10	BTN0988	1/4" MBSP x 3/8" FNPT

BAY ACCESSORIES

TRIGGER GUNS & LANCES



BRASS TRIGGERJET® LIGHT DUTY, LOW PRESSURE

SPRAYING SYSTEMS CO.



- Trigger valve for detail, tire cleaners, etc.
- **MAX FLOW:** 2 GPM
- **MAX PSI:** 250
- Trigger Valve Only
- **INLET & OUTLET** 1/4" NPT

\$35.37	GU0110	Trigger Valve - No Lock
\$7.94	GU0110K	Repair Kit



STAINLESS STEEL TRIGGER GUN

SPRAYING SYSTEMS CO.



- **INLET** 1/4" NPT
- **MAX PSI:** 150

\$139.93	GUSS3604-SS	Trigger Gun
\$13.28	GUSS3604K	Repair Kit



PLASTIC TRIGGERJET® LIGHT DUTY, LOW PRESSURE

SPRAYING SYSTEMS CO.

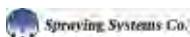

- Trigger lock for continuous flow
- Molded polypropylene
- **MAX PSI:** 150
- **INLET** 1/4" FPT
- Viton diaphragm

\$19.76	GUSS50
----------------	---------------

DID YOU KNOW...

Spraying Systems Co. has a proven track record for maximizing efficiency, minimizing waste and extending nozzle life!



TRIGGERJET® SPRAYER WITH LANCE

SPRAYING SYSTEMS CO.



- Molded polypropylene
- Trigger lock for continuous flow
- **MAX PSI:** 150
- 15" polyester extension
- Viton diaphragm
- **INLET & OUTLET** 1/4" FPT

\$31.11	GUSS70	15" Model
\$35.88	GUSS70-24	24" Model

TRIGGERJET® REPLACEMENT PARTS

SPRAYING SYSTEMS CO.



SNCP22668PP	Black Cap	SNCP387221PP	Black Polypropylene Core	GUSS70-RL	Lance Only	SNCP22661-VI	Viton Gasket
GUSS22663-24	24" Extension Wand	SNCP77175EPR	O-Ring	GUSS22655-PP	Trigger	SNCP22654	1/4" Handle
GUSS22664	Straight Adapter	SNCP38721PP	Tip Body	SNCP22657-NY	Stem		



TRIGGERJET® POLYPROPELENE REPLACEMENT NOZZLES

SPRAYING SYSTEMS CO.

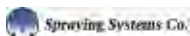

PRICE	PART #	SIZE	PRICE	PART #	SIZE
\$7.76	SNCJ55X3-PP	#3	\$7.76	SNCJ55X12-PP	#12
\$7.76	SNCJ55X6-PP	#6	\$7.76	SNCJ55X18-PP	#18
\$7.76	SNCJ55X8-PP	#8	\$7.76	SNCJ55X22-PP	#22



TRIGGERJET® BRASS REPLACEMENT NOZZLES

SPRAYING SYSTEMS CO.



PRICE	PART #	SIZE
\$15.16	SNCJ55X8	#8
\$15.16	SNCJ55X12	#12
\$15.16	SNCJ55X22	#22

WESTERN STYLE TIRE BRUSH WANDS

GOLDEN GATE CAR WASH SERIES



- 22" Long. Give your customers the convenience of cleaning their tires with the a tire brush wand. Brush, non-weep gun and spray tip sold separately.



22" FLOW THRU TIRE BRUSH WAND

GOLDEN GATE

\$29.43	GG22R-FT
----------------	-----------------



22" TIRE BRUSH WAND W/ 11" GRIP

GOLDEN GATE

\$32.05	GG22R
----------------	--------------



WHEEL WIZARD BRUSH

GOLDEN GATE CAR WASH SERIES

- Requires F x M Adapter!

\$15.57	EB47530	Brush
\$7.65	F0204A	Adapter



ROUND TIRE BRUSH

GOLDEN GATE CAR WASH SERIES

- Soft nylon brush with bumper

\$38.41	FORNDR
----------------	---------------

FITS DIRECTLY

BAY ACCESSORIES

NOZZLE PROTECTORS

NOZZLE PROTECTORS

J.E. ADAMS



- Extend the life of your nozzle and protect the finishes on your customers vehicles with flexible and durable nozzle protectors.

\$4.91	NP4F2F	1/4" F x 1/8" F
\$5.09	NP4F4F	1/4" F x 1/4" F
\$1.07	NPRR	Rubber Replacement



NOZZLE PROTECTORS

KLEEN-RITE



- Colorful nozzle protectors extend the life of your nozzle and protect the finishes on your customers vehicles.

\$1.63	NPBK	Black	\$1.63	NPOR	Orange
\$1.63	NPBL	Blue	\$1.63	NPS	Silver
\$1.63	NPR	Red	\$1.63	NPHP	Hot Pink



NOZZLE PROTECTORS

SUTTNER



\$7.38	SUTNP4F2F	1/4" F x 1/8" F
\$7.38	SUTNP4F4F	1/4" F x 1/4" F



NOZZLE PROTECTORS

SUTTNER



\$6.07	SUTNP10	Zinc 1/4"
\$6.68	SUTNP10SS	Stainless Steel 1/4"



NOZZLE PROTECTORS

GINSAN



- Can be used with both 1/8" or 1/4" nozzles.

\$3.10	NPGSBL	Blue
\$3.10	NPGSBK	Black



NOZZLE PROTECTORS

COMET PUMPS



\$3.08	NP114
---------------	--------------



ECONOMY NOZZLE PROTECTORS

HAMEL MANUFACTURING CO.



NP139BL	Blue
NP139R	Red
NP139BK	Black
\$1.51	



NOZZLE PROTECTORS

HAMEL MANUFACTURING CO.



NPHRBK	Black	NPHRP	Purple
NPHRBL	Blue	NPHRLB	Light Blue
NPHRHG	Hot Green	NPHRY	Yellow
NPHRHP	Hot Pink	NPHRR	Red
NPHRO	Orange	\$2.36	



NOZZLE PROTECTORS

MTM HYDRO



- 1/4" black nozzle

\$3.50	MTM410091	
---------------	------------------	--



NOZZLE PROTECTORS

SOUTHERN PRIDE

- 1/8" M x F

\$7.10	NP2M2F
---------------	---------------



NOZZLE PROTECTOR



NOZZLE

NOZZLE PROTECTORS

SPRAYING SYSTEMS CO.

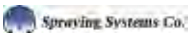

- Fits 1/8" or 1/4" nozzles.

\$1.59	NP2611
---------------	---------------

KLEEN-RITE HELPFUL HINT:

EXTEND THE LIFE OF YOUR NOZZLES.

Nozzle protectors help guard from breakage and wear from accidents like a dropped wand.

BAY ACCESSORIES

WANDS/LANCES

SUTTNER UNDERBODY LANCE

SUTTNER



- **MAX PSI:** 3000
- **MAX TEMP:** 300°F
- **INLET:** 1/4" MPT
- **OUTLET:** 1/4" FNPT
- **WEIGHT:** 6 lbs.
- Ideal for rinsing mud, dirt, snow or salt from under car/truck underbody
- Connects to existing pressure washer
- Ergonomic lance to reduce bending
- Uses 3 threaded MEG nozzles
- Comes with Suttner ST601 Spray Gun
- Lightweight - rolls easy with a long reach
- Plastic coated stainless steel pipe
- Stainless steel "chassis" and POM wheels

PRICE	PART #	MODEL
\$337.40	SUT97810	With Non-Weep Gun

PRICE	PART #	MODEL
\$345.78	SUT97811	With Weep Gun

NICKEL CHROME PLATED LANCE WITH MOLDED GRIP

SUTTNER



- **MAX PSI:** 6000 PSI
- **MAX TEMP:** 300°F
- **INLET:** 0.25" MPT
- **OUTLET:** 0.25" MPT

PRICE	PART #	LENGTH
\$9.03	SUT000180	24"
\$12.23	SUT000210	47"

PRICE	PART #	LENGTH
\$22.28	SUT000220	60"
\$24.23	SUT000230	79"

DOUBLE LANCE

GENERAL PUMP



- **MAX FLOW:** 10.5 GPM
- **MAX PRESSURE:** 4050 PSI
- **MAX TEMP.:** 320° F.
- **INLET:** 1/4"NPT-M
- **BRASS OUTLET:** 1/4" NPT-F

PRICE	PART #	TYPE	LENGTH
\$60.21	GPNDL33	Straight/Zinc	33"
\$60.21	GPNDL33B	Bent/Zinc	33"
\$78.56	GPNDL36	Bent/Zinc	36"

PRICE	PART #	TYPE	LENGTH
\$93.62	GPNDL72	Bent/Zinc	72"
\$69.90	GPNDL41SS	Straight/Stainless	41"

28" SELF-SERVE FOAMING WAND

MOSMATIC



- **MAX FLOW:** 12 GPM
- **MAX PRESSURE:** 4000 PSI
- **MAX TEMP.:** 212° F
- **INLET:** 3/8" F
- **WAND LENGTH:** 20"

\$164.23	BOMP29123
-----------------	------------------

20" SPRAY LANCE WAND

MOSMATIC



- Nozzle guards included

CALL	BOMP26980
-------------	------------------

20" SPRAY LANCE WAND WITH 8" GRIP

MOSMATIC



- Nozzle guards included

CALL	BOMP26981
-------------	------------------

36" LANCE WAND

KLEEN-RITE



- 1/4" M x 1/4" M

\$6.51	PWLW36
---------------	---------------

LANCE HANDLE

LANCE WANDS

- Fits on 1/4" wand pipes

\$6.69	PU21701
---------------	----------------

18" INSULATED LANCE

D&H SPRAY WANDS/LANCES

- Fits 1/4" pipe wand

\$17.50	WTL22003
----------------	-----------------

DON'T FORGET!



SNAP CLIP

D&H SPRAY WANDS/LANCES

- Fastens cover to wand

\$5.60	WTL22004
---------------	-----------------

BAY ACCESSORIES

WANDS/LANCES



18" SPRAY LANCE WANDS

HAMEL MANUFACTURING CO.



- Galvanized molded coated lance wands coated in rainbow colors!
- 1/4" M x 1/8" F - Available in 1/4" M x 1/4" M by special order

PRICE	PART #	COLOR	PRICE	PART #	COLOR
\$9.40	WTGMLBK	Black	\$9.40	WTGMLOR	Orange
\$9.40	WTGMLBL	Blue	\$9.40	WTGMLPR	Purple
\$9.40	WTGMLHG	Hot Green	\$9.40	WTGMLY	Yellow
\$9.40	WTGMLHP	Hot Pink	\$9.40	WTGMLR	Red



RUBBER COATED STEEL WAND PIPES

HAMEL MANUFACTURING CO.



- Rubber coating helps prevent scratches to customers vehicle.

\$7.93	WTRC18	Black
\$7.93	WTRC18BL	Blue
\$7.93	WTRC18R	Red



WAND PIPES

HAMEL MANUFACTURING CO.



- Threaded & tapped 1/4" ID pipe

GALVANIZED			STAINLESS STEEL		
PRICE	PART #	SIZE	PRICE	PART #	SIZE
\$5.01	WTG418	1/4" x 1/8"	\$14.61	WTS418	1/4" x 1/8"
\$5.57	WTG420	1/4" x 1/8"	\$15.80	WTS420	1/4" x 1/8"
\$6.96	WTG424	1/4" x 1/8"	\$14.61	WTS418MM	1/4"x 1/4 M x M
\$10.04	WTG436	1/4" x 1/8"	\$15.80	WTS420MM	1/4"x 1/4 M x M
\$5.01	WTG418MM	1/4" x 1/4 M x M			
\$5.57	WTG420MM	1/4" x 1/4 M x M			



1/4" x 18" SHOWN

CHROME PLATED WANDS WITH GRIP

J.E. ADAMS



- Lightweight, easy to handle, customer-friendly • Molded grip

1/4" MPT X 1/4" MPT			1/4" MPT X 1/8" FPT		
PRICE	PART #	LENGTH	PRICE	PART #	LENGTH
\$6.08	WTZ418MMWL	18"	\$7.30	WTZ418WL	18"
\$7.18	WTZ424MMWL	24"	\$14.08	WTZ424WL	24"
\$8.76	WTZ436MMWL	36"	\$19.22	WTZ436WL	36"



INJECTION MOLDED GRIP LANCE WANDS

HAMEL MANUFACTURING CO.



- Galvanized or stainless steel wand with Santoprene grip handle. Part numbers below are M x F. For two male ends, add MM to any of the part numbers. Size: 1/4" x 18"

GALVANIZED			STAINLESS STEEL		
PRICE	PART #	COLOR	PRICE	PART #	COLOR
\$15.46	WTG418WLBL	Blue	\$19.36	WTS418WLBL	Blue
\$15.46	WTG418WLR	Red	\$19.36	WTS418WLR	Red
\$15.46	WTG418WLBK	Black	\$19.36	WTS418WLBK	Black



FULL COVER PROTECTOR WAND

HAMEL MANUFACTURING CO.



- Durable high-impact plastic.
- Nozzle & tip protector holds it together. No need for snap clip!

FULL COVER WAND PROTECTOR			NOZZLE PROTECTOR		
PRICE	PART #	COLOR	PRICE	PART #	COLOR
\$8.86	WTLC100Y	Yellow	\$2.36	NPHRBL	Blue
\$8.86	WTLC100BK	Black	\$2.36	NPHRR	Red
			\$2.36	NPHRBK	Black



18" PROTECTOR WANDS

HAMEL MANUFACTURING CO.



- Protector wands have molded insulating fore grips and tip protector all in one piece. 7/8" outside diameter.

\$8.22	WTRCWNP-BK	Black
\$8.22	WTRCWNP-BL	Blue
\$8.22	WTRCWNP-R	Red



1/4" x 18" SHOWN

LIGHT WEIGHT CHROME WAND TUBE

J.E. ADAMS



- Lightweight, easy to handle, customer friendly

1/4" MPT X 1/8" FPT			1/4" MPT X 1/4" MPT		
PRICE	PART #	LENGTH	PRICE	PART #	LENGTH
\$2.93	WTZ418	18"	\$2.82	WTZ418MM	18"
\$5.72	WTZ424	24"	\$4.96	WTZ424MM	24"
\$10.42	WTZ436	36"	\$6.70	WTZ436MM	36"
			\$20.23	WTZ470MM	70"

BAY ACCESSORIES

WANDS/LANCES



RUBBER FLEX WANDS™

HAMEL MANUFACTURING CO.



- Galvanized or stainless steel extensions w/flexible center
- INLET PORT:** 1/4" MPT
- MAX PSI:** 2500
- MAX TEMP:** 200°
- OUTLET PORT:** 1/4" MPT x 1/8" FPT (for male or female nozzles)
- AVAILABLE IN 1/4 M x 1/4 M BY SPECIAL ORDER!**

CHECK OUT OUR INFORMATIVE VIDEO ABOUT THIS PRODUCT ON OUR WEBSITE, OR SIMPLY SCAN THIS HANDY QR CODE WITH YOUR HANDHELD MOBILE DEVICE: →



GALVANIZED RUBBER FLEX WANDS™

HAMEL MANUFACTURING CO.



\$19.85	WTGRFBK	18" MxF	Black
\$19.85	WTGRFBL	18" MxF	Blue
\$19.85	WTGRFHG	18" MxF	Hot Green
\$19.85	WTGRFHP	18" MxF	Hot Pink
\$19.85	WTGRFOR	18" MxF	Orange
\$19.85	WTGRFPR	18" MxF	Purple
\$19.85	WTGRFR	18" MxF	Red
\$19.85	WTGRFY	18" MxF	Yellow
\$22.19	WTGRF21BK	21" MxF	Black
\$22.19	WTGRF21BKMM	21" MxM	Black
\$22.19	WTGRF21BL	21" MxF	Blue
\$22.19	WTGRF21BLMM	21" MxM	Blue
\$22.19	WTGRF21R	21" MxF	Red
\$22.19	WTGRF21RMM	21" MxM	Red
\$22.70	WTGRF24BK	24" MxF	Black
\$22.70	WTGRF24BKMM	24" MxM	Black
\$22.70	WTGRF24BL	24" MxF	Blue
\$22.70	WTGRF24BLMM	24" MxM	Blue
\$22.70	WTGRF24R	24" MxF	Red
\$22.70	WTGRF24RMM	24" MxM	Red

STAINLESS STEEL RUBBER FLEX WANDS™

HAMEL MANUFACTURING CO.



\$23.93	WTSRFBK	18" MxF	Black
\$23.93	WTSRFBL	18" MxF	Blue
\$23.93	WTSRFHG	18" MxF	Hot Green
\$23.93	WTSRFHP	18" MxF	Hot Pink
\$23.93	WTSRFOR	18" MxF	Orange
\$23.93	WTSRFPR	18" MxF	Purple
\$23.93	WTSRFR	18" MxF	Red
\$23.93	WTSRFY	18" MxF	Yellow
\$29.46	WTSRF21BK	21" MxF	Black
\$29.46	WTSRF21BKMM	21" MxM	Black
\$29.46	WTSRF21BL	21" MxF	Blue
\$29.46	WTSRF21BLMM	21" MxM	Blue
\$29.46	WTSRF21R	21" MxF	Red
\$29.46	WTSRF21RMM	21" MxM	Red
\$34.15	WTSRF24BK	24" MxF	Black
\$34.15	WTSRF24BKMM	24" MxM	Black
\$34.15	WTSRF24BL	24" MxF	Blue
\$34.15	WTSRF24BLMM	24" MxM	Blue
\$34.15	WTSRF24R	24" MxF	Red
\$34.15	WTSRF24RMM	24" MxM	Red



SPRING FLEX WAND

WANDS

\$13.50	WTSPF14	1/4" x 14" M x M - No nozzle protector
\$16.99	WTSPF14-02	1/4" x 14" M x M with 1/8" Nozzle Protector
\$16.99	WTSPF14-04	1/4" x 14" M x M with 1/4" Nozzle Protector



ECONOMY RUBBER FLEX WAND® SPRAYERS

HAMEL MANUFACTURING CO.



\$14.52	WTERFR	Red Zinc-Plated
	WTERFBL	Blue Zinc-Plated
	WTERFBK	Black Zinc-Plated



WESTERN STYLE FLEXIBLE PROTECTOR WANDS

GOLDEN GATE CAR CARE SERIES



- 15" Long, Flexible Wand comes with fixed nozzle protector.

\$30.00	GG15BL
---------	--------

BAY ACCESSORIES

FOAMY BRUSH HANDLES



X-TRA HEAVY DUTY COATED ALUMINUM FOAMY BRUSH HANDLES

HAMEL MANUFACTURING CO.



- 40" Handles • 3/8" FIP x 1/2" MIP

FHA40BK	Black
FHA40BL	Blue
FHA40EG	Evergreen
FHA40HG	Green
FHA40HP	Hot Pink
\$15.81	

FHA40OR	Hot Orange
FHA40PR	Purple
FHA40R	Red
FHA40Y	Yellow
FHA40G	Gray
\$15.81	



STEEL & PVC FOAMY BRUSH HANDLES

HAMEL MANUFACTURING CO.



\$9.44	FHP40	PVC Handle	Gray - 40" x 3/4" w/Fitting 3/8" FIP x 1/2" MIP
\$17.09	FHS40BK	STEEL Handle	Black - 40" X-tra Heavy Duty Rubber Coated 3/8" FIP x 1/2" MIP

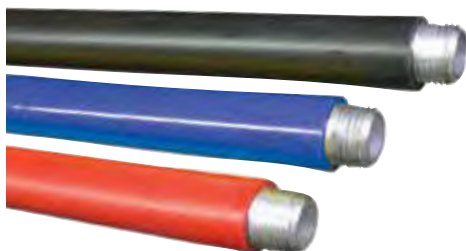

FOAMY BRUSH HANDLES

HAMEL MANUFACTURING CO.



60" LONG

HAMEL MANUFACTURING CO.

\$19.77	FHA60BL	Blue
	FHA60BK	Black
	FHA60R	Red

72" LONG

HAMEL MANUFACTURING CO.

\$24.88	FHA72BL	Blue
	FHA72BK	Black
	FHA72R	Red



SEMITRANSSPARENT FOAMY BRUSH HANDLE

HAMEL MANUFACTURING CO.



- 40" Long • Lightweight polycarbonate material

\$20.83	FHC40
----------------	-------



40" FOAMY BRUSH HANDLES

VALUE LINE PRODUCTS



\$10.05	KRV1220BK	Black
	KRV1220BL	Blue
	KRV1220R	Red

MOLDED GRIP FOAMY HANDLE

GOLDEN GATE CAR WASH SUPPLIES



- 36" Long • Injected Molded Handle Grip

\$35.45	GG36BL
----------------	--------



BAY ACCESSORIES

FOAMY BRUSH HOSES

25' COIL TUBING FOAMY HOSE HOSES

- Comes with fittings

1/4" 25 FEET			
\$31.46	CT2504BWF	Blue	
\$31.46	CT2504CWF	Clear/Blue Tint	
\$31.46	CT2504GWF	Hot Green	
\$31.46	CT2504RWF	Red	
\$31.46	CT2504YWF	Yellow	

3/8" 25 FEET			
\$58.77	CT2506BWF	Blue	
\$58.77	CT2506CWF	Clear/Blue Tint	
\$58.77	CT2506GWF	Hot Green	
\$58.77	CT2506RWF	Red	
\$58.77	CT2506YWF	Yellow	

5/16" 25 FEET			
\$46.47	CT2505BWF	Blue	
\$46.47	CT2505CWF	Clear	
\$46.47	CT2505GWF	Hot Green	
\$46.47	CT2505YWF	Yellow	



REPLACEMENT COIL TUBING FOAMY HOSE FITTINGS

POLY TUBING

\$6.98	CTF44S	1/4" CT x 1/4" M Swivel	\$9.05	CTF64S	3/8" CT x 1/4" M Swivel
\$8.57	CTF56S	5/16" CT x 3/8" M Swivel	\$9.05	CTF66S	3/8" CT x 3/8" M Swivel

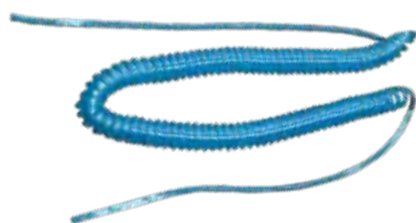

TRIPLE FOAM COILED HOSE

FREELIN-WADE HOSES

- Bonded ribbon Fre-Thane 95a polyurethane tubing material provides a clean wash with no unwanted residue or incomplete sealing. Reliable triple foam washes for your customers on every application, facilitated with a durable coil hose!
- 33' working length - 3 transparent blue tint tubes bonded together
- Hose only, fittings NOT included

\$92.99 CT1000

POLY FLEX FOAMY BRUSH HOSES

BULK HOSE

POLY FLEX FOAMY BRUSH HOSE

- 50' OR MORE • 250 PSI

POLY FLEX			
\$0.55	HPF06Y	3/8"	Yellow
\$0.53	HPF06R	3/8"	Red
\$0.53	HPF06B	3/8"	Blue
POLY BRAID			
\$0.52	HPB04H	1/4"	Clear
\$0.73	HPB06H	3/8"	Clear
\$0.94	HPB08H	1/2"	Clear



FOAMY HOSE ASSEMBLY

POLY FLEX FOAMY BRUSH HOSE

- Available in red, blue, and yellow
- 3/8" x 15' long
- One end is equipped with a 3/8" push lock fitting (**PLF204**) and one end has a **HU00606MB** fixed male permanent end with a, 3/8: MxF low pressure swivel (**SW0250**) attached
- Clear hose guard on one end for longer hose life

\$18.52	HA156FBL1443	Blue
\$18.83	HA156FY1443	Yellow
\$18.52	HA156FR1443	Red



SIGN UP FOR OUR WEEKLY EMAIL BLAST!

OUR WEEKLY E-BLAST FEATURES:

- Special Sale Offers
- Car Wash Hot Picks
- Featured Videos
- New Product Info
- Industry Calendar
- Sign up on the Kleen-Rite website!

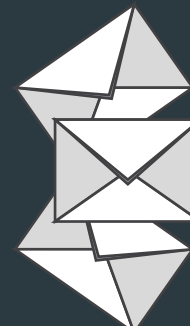

BAY ACCESSORIES

FOAMY BRUSH HANDLES

WOBBLEHEAD 3.0 SMART BRUSH HANDLE BRUSH HANDLES

Smart Brush Handle

- Precision engineered piston head and pushrod
- Wire braided reinforced flexible Wobble Zone Boot
- Fits all 1/2" foam brushes
- Saves wear and tear on brushes - hogs hair brushes last 2 to 4 times longer!
- Requires your customers to pay for use of your foam brush, generating more revenue for your wash

- 7/16" hardened stainless steel pushrod (guaranteed not to bend)
- Lightweight schedule 80 PVC handle (durable and will not corrode)
- All brass plumbing
- Compatible with all water and soap conditions - foam activates the stainless steel piston into Wobblezone

\$120.64 FWHH-BK Wobblehead Smart Brush Handle - Black

BEFORE THEY PAY

IT'S USELESS!



AFTER THEY PAY

IT'S USEFUL!



- Provides a better service for your customer
- Increases your revenue by 5-10%
- Decreases your level of frustration

BENEFITS

- Easy to Install - Remove and replace
- No additional equipment to purchase
- Requires the SS customer to pay for the use of your foam brush
- Increases the life of the Hogs hair brush by 2-4x longer
- Fast ROI in as little as 2 months
- Silent Attendant with a passive and polite approach to have your customer pay

REPLACEMENT PARTS SMART BRUSH HANDLE

\$57.99	FHWH-BOOT	Aluminum Handle Boot (sold before 2017) 1/2" x 1/2"
\$57.99	FHWH-BOOT-3.0	Handle Boot (sold after 2017) 3/4" x 1/2"
\$6.22	FHWH-SPRING	Replacement Spring (all since 2010)
\$14.70	FHWH-GRIP-3.0	Shrink Wrap Tubing (sold after 2017)

All materials are now compatible with all water conditions and soap formulas!

BRUSH AND WAND HOLDERS



STAINLESS STEEL NON-FLEXIBLE WAND HOLDER

HAMEL MANUFACTURING CO.

\$22.78	WHS06	6"
\$44.66	WHS17	17"
\$52.18	WHS22	22"
\$52.87	WHS24	24"



STAINLESS STEEL FLEXIBLE WAND HOLDER

BAY ACCESSORIES

- 26" Long • 2 1/2" Diameter
- Fitting on bottom for drip recycling

\$104.05 WHFS26



STAINLESS STEEL WAND HOLDER WITH BUMPER

VALUE LINE

- 2.5" O.D.

\$28.99	KRV1210	17" Long
\$34.99	KRV1212	22" Long



STAINLESS STEEL FLEXIBLE WAND HOLDER

VALUE LINE

- 26" long

\$62.75	KRV1214	Wall Mount
\$62.75	KRV1216	Floor Mount
\$6.25	KRV1217	Replacement Ring



FLOOR MOUNTED WAND HOLDER WITH WEEP CONNECTION

MOSMATIC



- Length: 27.8" • Inner Diameter: 2.4"
- Outer Base Diameter: 6.3"
- Weep connection 0.8" diameter
- Spring loaded with recovery port
- Solid construction
- Made of high-polished stainless steel

CALL BOMP29097



WAND HOLDER

MOSMATIC



- DIMENSIONS: 23.2" x 2.4" • Polished stainless steel
- Tough, durable construction

CALL BOMP29083

BAY ACCESSORIES

BRUSH AND WAND & GUN HOLDERS



SNAP-IN STAINLESS STEEL BASE FOAM BRUSH HANDLE HOLDERS

HAMEL MANUFACTURING CO.



\$17.76	FBHH916	Red
\$17.76	FBHH916BL	Blue

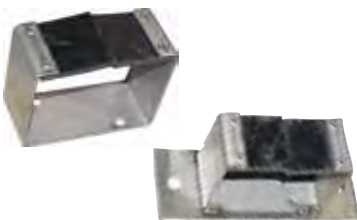

FOAMY BRUSH HOLDER

BAY ACCESSORIES

\$21.38	FHH300	Standard
\$24.59	FHH300-R	Reinforced



STAINLESS STEEL FOAMY BRUSH BOX HOLDER

BAY ACCESSORIES

- Holds brush horizontally
- Keeps brush from freezing
- Available in left and right configurations

\$197.13	FBHSS	Right
\$196.53	FBHSSL	Left



FOAM BRUSH HOLDER PLATE

BAY ACCESSORIES

\$11.55	FBHP
----------------	-------------



FOAMY BRUSH BUCKET

HAMEL MANUFACTURING CO.



\$14.04	FBB911R	Red
	FBB911BL	Blue
	FBB911BK	Black



FOAMY BRUSH BUCKET

BAY ACCESSORIES

- 11" L x 6" W x 6" D
- Use with foamy weep system
- Heavy duty polyethylene

\$13.90	F00260	Blue
\$13.90	F00261	White



STAINLESS STEEL GUN HOLDER FOR TRIFOAM GUN

BAY ACCESSORIES

\$25.44	TFGHSS
----------------	---------------



SUPER NOZZLE STAINLESS STEEL HOLDER

ERIE BRUSH



\$20.11	EB218022
----------------	-----------------



STAINLESS STEEL 2 PRONG FOAM HOOK BRUSH

HAMEL MANUFACTURING CO.



- 2 prong hook 1½" x 5" L
- 1/2" holes are 4" apart

\$11.40	FBH915
----------------	---------------



J HOOK

HAMEL MANUFACTURING CO.



- Neatly attach hose & brushes to wall
- Pre-drilled mounting holes.

\$6.83	FBH919S	Stainless
\$8.03	HHRC6	Powder Coated



BLACK RUBBER COATED GUN HOSE HOOK

KLEEN-RITE



- Stainless steel construction with rubber coating

\$9.19	HHRC4
---------------	--------------



STAINLESS STEEL FOAMY HANDLE HOLDER

BAY ACCESSORIES

\$23.50	FHHS316
----------------	----------------

BAY ACCESSORIES

MAT CLAMPS



MAT CLAMPS

HAMEL MANUFACTURING CO.



PRICE	PART#	MATERIAL	BUMPER	COLOR	TYPE
\$12.29	MCSC35	Stainless	Yes	Red	Channel
\$12.29	MCSC35BL			Blue	
\$14.27	MCSC35Y			Yellow	
\$14.27	MCSC35P			Purple	
\$14.27	MCSC35G			Green	
\$2.85	MCSP50	Replacement Spring			

CHANNEL



6½" X 1¼" MAT CLAMP DECALS

HAMEL MANUFACTURING CO.



\$2.25	MCD57BL	Blue
\$2.25	MCD57	Red
\$2.85	MCD57P	Purple
\$2.85	MCD57G	Green
\$2.85	MCD57Y	Yellow



MAT CLAMPS

VALUE LINE



- Wall mounted - steel pin included
- Bumper for safe use
- Decal included

PRICE	PART#	COLOR
\$8.99	KRV1200R	Red
\$8.99	KRV1200BL	Blue



MAT CLAMP BUMPER

HAMEL MANUFACTURING CO.



- Plastic bumper ensures mat is held firmly in place
- Durable plastic material prevents damage to rubber or fabric mats
- Fits Hamel 825SD and 925 AD clamps

\$3.52	MCB-G	Green
\$3.52	MCB-P	Purple
\$3.52	MCB-RED	Red
\$3.52	MCB-Y	Yellow



SUPER HEAVY DUTY STAINLESS STEEL FLOOR MAT CLAMP

KLEEN-RITE



- Strong, durable stainless steel, this mat clamp provides an easy place for customers to hang their floor mats - perfect for use at commercial car washes
- Hang on a wall/sturdy flat surface
- Single mat clamp
- Pre-cut sections for screws and fasteners when hanging
- Lettering directly on metal: MAT CLAMP and PUSH HERE

\$24.99 KRMC100



STAINLESS STEEL MAT HOLDER WITH PRESSURE ROLLER

MOSMATIC



- DIMENSIONS: 12" H x 1.8" W x 2.4" D
- Plastic pressure roller allows for firm clamping without causing damage to floor mats
- 100% stainless steel construction
- 100% maintenance-free design

CALL BOMP90050

FOAM BRUSH

MOSMATIC



- Stainless steel brush head
- Non-marking rubber trim
- High quality hogs hair bristles
- Swiveling inlet

CALL	BOMP25922	41"
	BOMP25923	50"



COMPLETE HOGS HAIR HEAD BRUSH

MOSMATIC



- Lightweight design - 1.3 lbs
- 1/4" NPT female Inlet
- 2.4: Natural hogs hair bristles

CALL BOMP29007



HOGS HAIR REPLACEMENT BRUSH

MOSMATIC



- Uses foamy brush handle

CALL	BOMP29011	2.4"
	BOMP29065	3.5"



BAY ACCESSORIES

Universal Brush



BRUSHES

New!



BOARTEX ULTRA PLASTIC FOAM BRUSH

UNIVERSAL BRUSH

- Filled with BOARTEX - soft, synthetic bristles that offer the look, feel, like hogs hair
- 10" wide with 3" exposed bristle length
- Used with standard foam brush handles

\$39.63	F08800-BL	Blue
\$39.63	F08800-BK	Black
\$39.63	F08800-R	Red

New!



BOARTEX ULTRA ALUMINUM FOAM BRUSH WITH BUMPER

UNIVERSAL BRUSH

- A flow-through foam brush made of aluminum with a bumper and BOARTEX synthetic bristle fill
- 10" wide with 3" exposed bristle length
- Used with standard foam brush handles

\$40.85	F09800-BL	Blue
\$40.85	F09800-BK	Black
\$40.85	F09800-R	Red



4" MONSTER HOGS HAIR WITH ALUMINUM HEAD

UNIVERSAL BRUSH

- Higher volume of bristles, 20% more density than the standard hogs hair brush
- Uses foamy brush handle

\$74.42	F0211AR	Red
\$74.42	F0211ABL	Blue
\$74.42	F0211ABK	Black
\$74.42	F0211AY	Yellow
\$74.42	F0211AG	Green
\$74.42	F0211APR	Purple



4.5" MONSTER XL HOGS HAIR WITH ALUMINUM HEAD

UNIVERSAL BRUSH

- Longer length bristles, 20-25% longer than standard hogs hair brush
- Universal's largest foamy brush ever!
- Uses foamy brush handle

\$80.81	F0211AR-XL	Red
\$80.81	F0211ABL-XL	Blue
\$80.81	F0211ABK-XL	Black



4" MONSTER HOGS HAIR WITH RUBBER COATED HEAD

UNIVERSAL BRUSH

- Higher volume of bristles, 20% more density than the standard hogs hair brush
- Uses foamy brush handle

\$73.26	F0212PR	Red
\$79.65	F0212PBL	Blue
\$73.26	F0212PBK	Black
\$64.64	F0213HR	Refill



4.5" MONSTER XL HOGS HAIR WITH RUBBER COATED HEAD

UNIVERSAL BRUSH

- Longer length bristles, 20-25% longer than standard hogs hair brush
- Universal's largest foamy brush ever!
- Uses foamy brush handle

\$80.38	F0212PR-XL	Red
\$80.38	F0212PBL-XL	Blue
\$80.38	F0212PBK-XL	Black



NYLON FOAMY BRUSH WITH PLASTIC HEAD

UNIVERSAL BRUSH

- 9 1/4" x 2 1/4" plastic head
- 2 1/4" long bristles
- Uses foamy brush handle

\$33.71	F0315PN	Blue Head - Black Brush
\$33.71	F0316PN	Blue Head - Blue Brush
\$33.71	F0317PN	Black Head - Black Brush
\$33.71	F0318PN	Red Head - Red Brush
\$25.61	F0315PNR	Black Refill
\$25.61	F0318PNR	Red Refill
\$25.61	F0320NBLR	Blue Refill



NYLON FOAMY BRUSH WITH ALUMINUM CASTING

UNIVERSAL BRUSH

- 9 1/4" x 2 1/4" aluminum head
- 2 1/4" long bristles
- Uses foamy brush handle

\$34.88	F0320NBL	Blue
\$25.61	F0320NBLR	Blue Refill
\$34.88	F0320NR	Red
\$25.61	F0318PNR	Red Refill
\$34.88	F0320NBK	Black
\$25.61	F0315PNR	Black Refill

BRUSH AND BUMPER COLOR MATCH

BAY ACCESSORIES



Universal Brush

BRUSHES

HOGS HAIR TRIPLE SURFACE FOAM BRUSH WITH SIDES

UNIVERSAL BRUSH

- Fits in 5 gallon bucket
- Use with foamy brush handle - requires FO204A adapter

\$109.30	F01808	Brush
\$7.65	F0204A	Adapater



BOARTEX ULTRA WASH BRUSH WITH SIDES

UNIVERSAL BRUSH

- 3" bristle length
- Specialized synthetic Noghair bristles
- Use with foamy brush handle - requires FO204A adapter

\$36.71	F01808-BTX	Brush
\$7.65	F0204A	Adapater



8" HEAD FEATHER TIP TRIPLE SURFACE XL FOAM BRUSH WITH SIDES

UNIVERSAL BRUSH

- Fits in 5 gallon bucket
- Use with foamy brush handle - requires FO204A adapter

\$20.42	F01808G	Green
\$20.42	F01808R	Red
\$20.42	F01808BL	Blue
\$7.65	F0204A	Adapater



HOGS HAIR BRUSH WITH BUMPER AND ALUMINUM CASTING

UNIVERSAL BRUSH

- 4" long bristles
- 9 1/4" x 2 1/4" head
- Uses foamy brush handle

\$66.86	F0194AH	Red Bumper
\$66.86	F0195AH	Blue Bumper
\$66.86	F0196AH	Black Bumper
\$66.86	F0198AH	Yellow Bumper
\$66.86	F0199AH	Green Bumper
\$66.86	F0193AH	Purple Bumper
\$52.33	F0198HR	Refill



88BH HOGS HAIR FOAM BRUSH

UNIVERSAL BRUSH

- 4" long bristles
- 9 1/4" x 2 1/4" plastic head
- Uses foamy brush handle

\$65.70	F0197PHBK	Black Head
\$65.70	F0197PHR	Red Head
\$65.70	F0198PH	Blue Head
\$52.33	F0198HR	Refill



NYLEX FOAMING BRUSH

UNIVERSAL BRUSH

- Uses foamy brush handle

\$38.42	F088BNX-BK	Black
\$38.42	F088BNX-BL	Blue
\$38.42	F088BNX-GR	Green
\$38.42	F088BNX-R	Red



ROUND HOGS HAIR

UNIVERSAL BRUSH

- 4" long bristles
- 5 1/2" diameter head
- Refills not available
- Uses foamy brush handle

\$81.98	FORNDH	Blue
\$81.98	FORNDHBK	Black
\$81.98	FORNDHR	Red



ROUND TIRE BRUSH WITH RED PLASTIC HEAD

UNIVERSAL BRUSH

- 2" stiffer bristles
- 5 1/2" diameter head
- Refills not available
- Uses foamy brush handle

\$38.41	FORNDR
----------------	---------------



ROUND BLACK NYLON BRUSH

UNIVERSAL BRUSH

- Black bristles
- 5 1/2" diameter plastic head
- Refills not available
- Uses foamy brush handle

\$38.41	FORNDN
----------------	---------------



ROUND BLUE NYLON BRUSH

UNIVERSAL BRUSH

- Blue bristles
- 5 1/2" diameter plastic head
- Refills not available
- Uses foamy brush handle

\$38.41	FORNDBL
----------------	----------------



BAY ACCESSORIES

Universal Brush 

BRUSHES

F0400-R

F0400-BL

F0400



10" BI-LEVEL FEATHER TIP BRUSHES

UNIVERSAL BRUSH

- Dual surface brushes feature a split brush shape with two position bristle trim
- 10" solid foam block with a threaded handle hole.

\$19.45	F0400	Green	\$19.45	F0400-BL	Blue
\$19.45	F0400-R	Red			



10" BI-LEVEL HOGS HAIR BRUSH

UNIVERSAL BRUSH

\$83.71 F0403



TRIPLE SURFACE HOGS HAIR

UNIVERSAL BRUSH

- Extra wide coverage means less prep time. Hog filled sides for extra protection

\$111.76 F01800



WHEEL BRUSH

UNIVERSAL BRUSH

- Uses broom handle

\$14.19 F0332



10" HOGS HAIR TRUCK BRUSH

UNIVERSAL BRUSH

- Uses broom handle
- Heavy-duty head

\$63.95 F0330



10" HOGS HAIR WITH BUMPER

UNIVERSAL BRUSH

- Prep brush

\$63.96 F0103



10" GREEN BRISTLE BRUSH WITH BUMPER

UNIVERSAL BRUSH

- Light green bristles
- Feather tip ends
- Soft bumper wraps around top

\$13.95 F0101



10" SYNTHETIC BRUSH WITH FEATHER TIP ENDS

UNIVERSAL BRUSH

- Uses broom handle
- Heavy-duty head

\$14.63 F0202Y



ROUND PREP BRUSH

UNIVERSAL BRUSH

- Soft, natural hog's hair
- Great for rims and tires
- Safe, scratch-free washing

\$118.30 F01600

BAY ACCESSORIES



BRUSHES



STACK BRUSH
UNIVERSAL BRUSH

- Uses broom handle

\$24.39 BRSTACK



5" ROUND UPHOLSTERY BRUSH
UNIVERSAL BRUSH

- Clean auto upholstery and headliners

\$25.02 F0901



5" WHEEL APPLICATOR BRUSH
UNIVERSAL BRUSH

- Crimped flagging holds tire cleaner better than standard brushes!

\$14.74 F01105



5" NYLON WHEEL & TIRE BRUSH
UNIVERSAL BRUSH

- 5" red nylon. GREAT for tires & rims. One standard threaded hole means no more bending over!

\$11.04 F01104



7" TOOTHBRUSH STYLE BRUSHES
UNIVERSAL BRUSH

- Perfect for the general cleaning of small parts and detail finishing areas!

\$2.37	F01300	Stainless Steel
\$2.37	F01301	Brass
\$2.37	F01302	Horsehair



SPARE PARTS
UNIVERSAL BRUSH

\$10.88	F0193AC	Aluminum Casting	\$8.46	F0193G	Green Bumper
\$8.46	F0193BL	Blue Bumper	\$8.46	F0193PR	Purple Bumper
\$8.46	F0193BK	Black Bumper	\$11.89	F0193PC	Blue Plastic Casting
\$8.46	F0193R	Red Bumper	\$11.89	F0193PCR	Red Plastic Casting
\$8.46	F0193Y	Yellow Bumper	\$0.82	F0194US	Bolts for Brush



FAUX HOG'S HAIR BRUSH

BOARTEX BY UNIVERSAL BRUSH



- Synthetic hogs hair bristles
- One-piece bumper
- Uses foamy brush handle

\$38.46 BRB2000



Universal Brush takes great pride in continuing to manufacture all of its products here in the USA!

Universal Brush has distinguished itself over the years as a trusted and dependable supplier to the car wash industry by offering the highest quality, most reliable and consistent products at a fair price.

BAY ACCESSORIES



ERIE FOAMMASTER® BRUSHES

FOAMMASTER® LIGHTWEIGHT HOGS HAIR BRUSH WITH 3¼" BRISTLES

ERIE BRUSH

- 10" wide
- Uses foamy brush handle
- Blue bumper

\$50.66	EB212641	Aluminum Head	\$44.52	EB212683	3¼" Hogs Hair Refill
\$50.66	EB212651	Black Plastic Head			

FOAMMASTER® HOGS HAIR BRUSH WITH 4½" BRISTLES

ERIE BRUSH

- 10" wide
- Uses foamy brush handle

\$77.25	EB212370	Aluminum Head - Black Bumper	\$77.25	EB212570	Plastic Head - Black Bumper
\$77.25	EB212371	Aluminum Head - Blue Bumper	\$77.25	EB212571	Plastic Head - Blue Bumper
\$71.54	F0199PHR	4½" Hogs Hair Refill			

FOAMMASTER® HOGS HAIR BRUSH WITH 4" BRISTLES

ERIE BRUSH

- 10" wide
- Uses foamy brush handle

\$64.31	F0202PH	Black Plastic Head - Black Bumper	\$64.89	F0202AH	Aluminum Head - Black Bumper
\$64.31	EB212501	Black Plastic Head - Blue Bumper	\$64.89	F0202AHBL	Aluminum Head - Blue Bumper
\$64.31	EB212502	Black Plastic Head - Red Bumper	\$64.89	F0202AHR	Aluminum Head - Red Bumper
\$61.59	F0203HR	4" Hogs Hair Refill			

FOAMMASTER® BLACK PLASTIC HEAD WITH NYLON 2½" BRISTLES

ERIE BRUSH

- 10" wide
- Uses foamy brush handle

\$28.88	F0205PBL	Black Plastic Head - Blue Bumper - Blue Bristles
\$28.88	F0205PR	Black Plastic Head - Red Bumper - Red Bristles
\$28.88	F0205PBK	Black Plastic Head - Black Bumper - Black Bristles

FOAMMASTER® ALUMINUM HEAD WITH NYLON 2½" BRISTLES

ERIE BRUSH

- 10" wide
- Uses foamy brush handle

\$28.88	F0205ABL	Blue Bristles - Blue Bumper
\$28.88	F0205AR	Red Bristles - Red Bumper
\$28.88	F0205ABK	Black Bristles - Black Bumper

FOAMMASTER® NYLON REFILLS WITH NYLON 2½" BRISTLES

ERIE BRUSH

- Uses foamy brush handle

\$20.57	F0206RBL	Blue Refill
\$20.57	F0206RR	Red Refill
\$20.57	F0206RBK	Black Refill

BAY ACCESSORIES



ERIE FOAMMASTER® BRUSHES



ROUND FOAMMASTER® HOGS HAIR BRUSH 6" DIAMETER
ERIE BRUSH

- Uses foamy brush handle
- Black plastic head

\$80.68 EB21930B 4" Bristles



ROUND FOAMMASTER® NYLON BRUSH 6" DIAMETER
ERIE BRUSH

- Uses foamy brush handle
- Black plastic head

\$29.58	EB21960	Black 2.5" Brush
\$29.58	EB219620	Blue 2.5" Brush
\$34.93	EB219621	Blue 1.75" Brush
\$29.58	EB219640	Red 2.5" Brush

ERIE FOAM BRUSH REPLACEMENT PARTS



ALUMINUM CASTING
ERIE FOAM BRUSH REPLACEMENT PARTS

\$8.86 F0208AC



BLACK PLASTIC CASTING
ERIE FOAM BRUSH REPLACEMENT PARTS

\$8.86 F0208PC



RUBBER BUMPER
ERIE FOAM BRUSH REPLACEMENT PARTS

\$3.94	F0207BL	Blue
	F0207R	Red
	F0207BK	Black



SCREWS
ERIE FOAM BRUSH REPLACEMENT PARTS

\$1.68	F0209ESA	SHORT - Aluminum Heads
\$0.62	F0209ESP	LONG - Plastic Heads

ERIE BRUSHES



TRIPLE SURFACE BI-LEVEL WITH SQUEEGEE
ERIE BRUSH

- Uses broom handle
- 10" wide

\$29.93	EB224921	2.5" Bristle - Green Nylon
\$111.95	EB224906	4" Bristle Hogs Hair



HOGS HAIR TRUCK BRUSH W/ BUMPER
ERIE BRUSH

- 10" wide • 4" Bristle • Uses broom handle

\$88.51 EB23350



ALL AROUNDER® HOGS HAIR BRUSH
ERIE BRUSH

- Genuine hogs hair bristle fill
- Acme female thread hole - no handle included

\$143.32 EB259580

BAY ACCESSORIES



ERIE BRUSH



THE ONLY TRIPLE SURFACE BI-LEVEL BRUSH

HOGS HAIR TRIPLE SURFACE BI-LEVEL BRUSH

ERIE BRUSH

- Uses broom handle
- 10" Wide
- 4" Bristles

\$117.34 F0220



BLACK & WHITE FEATHER TIP BI-LEVEL BRUSH

ERIE BRUSH

- Uses broom handle
- 10" Wide
- 2.5" Styrene Bristles

\$16.64 F0204



HI-LO SOFT SIDER HOGS HAIR BRUSH - DENSE FILL

ERIE BRUSH

- 10" Block

\$156.08 EB226127



HI-LO SOFT SIDER HOGS HAIR BRUSH - DENSE FILL

ERIE BRUSH

- 4" Bristle
- 5" Block
- 55% more fill than model 226508

\$112.16 EB226514

New!



HI-LO SOFT SIDER HOGS HAIR BRUSH

ERIE BRUSH

- 10" Block

\$105.65 EB226125

New!



HI-LO SOFT SIDER HOGS HAIR BRUSH

ERIE BRUSH

- 4" Bristle
- 5" Block

\$74.70 EB226508



FEATHER TIPPED TRUCK BRUSH NO BUMPER

ERIE BRUSH

- 10" wide
- Uses broom handle

\$14.02 EB232650



EQUIPMENT/WALL POLY BRUSH

ERIE BRUSH

- 9" wide
- 2.5 bristle
- Uses broom handle

\$12.61 EB245570



NYLON TRIPLE SURFACE BI-LEVEL BRUSHES

ERIE BRUSH

- Uses broom handle
- 10" Wide
- 2½" Bristle

\$25.69 EB225200 Green Nylon
\$33.70 EB225301 Blue Nylon



WHEEL WIZARD®

ERIE BRUSH

- Uses broom handle

\$34.14 EB47700 Hogs Hair
\$15.57 EB47530 Red Nylon
\$15.57 EB47540 Green Nylon
\$15.57 EB47520 Blue Nylon



ERIE BRUSH - SPOKE BRUSHES



ULTRA CLOTH SPOKE BRUSH

ERIE BRUSH

\$9.72 EB275550 11"
\$11.40 EB275580 16"



TAMPICO SPOKE BRUSH

ERIE BRUSH

\$3.56 EB27451 10"
\$5.19 EB27450 16"

BAY ACCESSORIES

HOGS HAIR FOAMY BRUSHES



BUBBLE BRUSH

INKFISH



- Designed for self-serve foaming brush applications. Its curved head reaches corners and other hard to reach areas. Made with premium hog's hair that won't scratch paint.
- Black Color Block/ 3.75" Length
- Over 200 Holes filled with Premium Hogs Hair
- Adapter included so you can use as a prep brush

\$89.99 BR1020-BK Black

ROUND HOGS HAIR FOAMY BRUSH WITH REPLACEABLE HEAD

INKFISH



- This round 4" foamy brush boasts genuine hog hair bristles with naturally feathered ends
- Soft rubber bumper gasket, a brass NPT thread, and a recessed hex screw on the top
- Modular design that allows for replacement brush cartridges
- 6" Diameter head with 4" bristles

REMOVING & REPLACING THE CARTRIDGE:

- Use an Allen wrench to gently turn the hex screw one or two rotations (do not remove)
- Grab the bristles with one hand and the head with the other hand and spin the cartridge to the left (left if you're looking from the bottom of the brush)
- Remove the cartridge and replace with new cartridge. Spin into place
- Once cartridge is even around the edges and snugly in place, gently turn the hex screw. Do not over-tighten

\$51.99 BR1016-BK Black
\$51.99 BR1016-BL Blue
\$41.99 BR1016-RC Replacement Cartridge

REPLACEABLE HEAD!



HOG DADDY 4" HOGS HAIR FOAMY BRUSH

KLEEN-RITE



- High-quality Hog Daddy hogs' hair is durable, yet soft on car surfaces.
- Excellent water-holding ability while retaining stiffness.
- One-piece construction. Meaning, no worrying about accidental insert separation causing a poor wash.
- With no nylon or synthetic bristles, HogDaddy is ideal for clear coats, gel coats, glass, plexiglass, and chrome!
- Low shedding during use.

\$55.25 KRV1102-BL Blue Head
\$55.25 KRV1102-R Red Head
\$55.25 KRV1102-BK Black Head



HOG KING 4.5" HOGS HAIR BRUSHES

KLEEN-RITE



- Aluminum Head: Added durability to withstand a variety of conditions
- Soft Rubber Bumper: Bumper gasket to protect your brush subject from scratches or scrapes
- 4.5" Long Hog's Hair Bristles: Smoothly guides foam across brushing area
- Stainless Steel Plate Screws: Great stability for full control

\$58.99 KRV1100R Red
\$58.99 KRV1100BL Blue
\$58.99 KRV1100 Black

EAR STYLE HOGS HAIR BRUSH

VALUE LINE BRUSHES



- Approx. 4.5" brush hair length
- 8" rubber bumper head
- Ear style brush
- Naturally feathered hairs
- Maximum density for ensuring prolonged usage and extra protection

\$86.99 KRV1125



BAY ACCESSORIES

BRUSHES



TRIPLE SIDED HOGS HAIR BRUSH
VALUE LINE BRUSHES



- A cost-effective tool for getting the job done right! Authentic hog's hair fibers facilitate an easier detailing process with no scratching
- Approx. 4.5" brush hair length
- 9.5" rubber bumper head
- Triple sided for more coverage
- Naturally feathered hairs ensure no surfaces or paint finishes are scratched
- Maximum density for ensuring prolonged usage and extra protection

\$91.75 **KRV1120**



WASH BRUSHES
HARPER BRUSH



- Uses broom handle • 14" truck brush w/o bumper

\$20.29 **LT8150**



10" BI-LEVEL BRUSH
HARPER BRUSH



- Uses broom handle

\$18.14 **LT1500**



TAMPICO WHITE WALL & TIRE BRUSH
WEILER BRUSH



- These brushes are well-suited for light duty applications and greater flexibility. They can be used for delicate, scratch-free brushing

\$4.31 **BR0150** 8 ½"

\$6.34 **BR0152** 20"



20" PALMYRA WHITE WALL & TIRE BRUSH
WEILER BRUSH



- For general scrubbing in factories, kitchens, institutions, etc.

\$5.43 **BR0158**



WHITE WALL & TIRE BRUSH
WEILER BRUSH



- Brass bristle, foam block

\$6.08 **BR0165**



10" GRAY SCHOOL BUS BRUSH
WEILER BRUSH



- Uses broom handle
- Hardwood block top

\$7.46 **BR0105**



10" HEAVY DUTY TRUCK BRUSH
WEILER BRUSH



- Uses broom handle
- Protective bumper
- Foam block with two handle holes

\$14.76 **BR0106** Green
\$14.90 **BR0108** White



BI-LEVEL GREEN DETAIL BRUSH
WEILER BRUSH



- Uses foamy brush handle
- Bi-level design allows brush to stay in contact with surface

\$25.78 **BRBL10**

BAY ACCESSORIES

BRUSH HANDLES



5' BLACK COATED 15/16" METAL HANDLE
HARPER BRUSH HANDLES



- With hang-up swivel

\$7.47 LT563



4' SANDED 7/8" WOOD HANDLE
HARPER BRUSH HANDLES



- For squeegee

\$2.39 LT536



5' LACQUERED 15/16" WOOD HANDLE
HARPER BRUSH HANDLES



- With metal Tip

\$6.67 LT562



5' LACQUERED 1 1/8" WOOD HANDLE
HARPER BRUSH HANDLES



- For squeegee

\$5.88 LT552



BRUSH HANDLES

WEILER BRUSH



\$5.09	BR0201	4' tapered wooden handle with 15/16" threaded metal tip
\$5.36	BR0212	5' threaded wooden handle with 15/16" tip
\$15.73	BR0213	53 1/2" threaded 1" fiberglass handle with honeycomb core - Yellow
\$4.97	BR0230	5' Vortec Pro® metal handle with 15/16" threaded plastic tip and convenient hang-up cap
\$7.05	BR0220	6' wooden handle with heavy Duty 15/16" threaded metal tip
\$1.17	BR0300	Replacement fiberglass handle thread. Fits any 15/16" diameter handle
\$2.02	BR0305	Reinforcing steel brace - Locks handle to block - FITS ALL HANDLE SIZES

AIR SWITCHES & PARTS



#32 N/O WITH ALUM. BOX
AIR SWITCHES

\$23.12 AS32WB



#32 NORMALLY OPEN
AIR SWITCHES

\$19.67 AS32



#16 NORMALLY OPEN
AIR SWITCHES

\$15.80 AS16



DRIVEWAY SIGNAL BELL
PARTS

\$56.03 AS10SB



3/8" DRIVEWAY BELL HOSE
MASTER SIGNAL PARTS

- Per foot • Used with air switch

\$1.00 H00150



RUBBER PLUG
PARTS

\$1.25 ASHP



HOSE SPLICER
PARTS

- Connector for 3/8" ID Hose

\$4.90 AS17



HOSE ANCHOR
PARTS

\$21.13 AS14

BAY ACCESSORIES

LOCKS



MEDECO SCREW LOCK LOCKS

- The Medeco unique design provides triple locking action, making the locks virtually pick-proof.
- Fully threaded
- **COMES WITH 1 KEY**

PRICE	PART #	SIZE	FITS
\$64.28	L00195	3"	Old style Round Monorail
\$64.28	L00197	4"	G-2 Vac
\$64.28	L00198	4 3/4"	Kleen-Rite 6165 coin box

MEDECO CAM LOCK LOCKS

- All Medeco cylinders are constructed of durable machined brass components, designed to last the life of your equipment. Hardened stainless steel inserts inside the cylinder provide the ultimate defense against drilling and other forms of physical attack. Unique elevating and rotation tumbler pin system is virtually pick-proof.
- **COMES WITH 1 KEY**

PRICE	PART #	SIZE	DETAILS
\$53.11	L00137	5/8"	Fits most coin boxes
\$53.90	L00138	7/8"	Fits Adams Vac Coin Box

MEDECO PLUG LOCK LOCKS

- Fits all popular brands of changers and D&S Safes

\$41.10	L00190	Plug Lock & Key
\$29.24	L00193	Housing Only
\$12.58	L00191	Key Only

MEDECO SWITCH LOCK LOCKS

- This 3/4" diameter switch lock offers a wide range of electrical functions combined with the security and key control of a Medeco cylinder. Great for applications requiring controlled access to electrically activated systems.
- **COMES WITH 1 KEY**

\$66.04	L00139
---------	--------

MEDECO T HANDLE LOCK LOCKS

- Four pin standard
- Dead and spring bolt functions available. 180 degree rotation to open.
- Locks fit all NAMA standard T-handles
- **COMES WITH 1 KEY**

\$46.80	L00196
---------	--------



6 1/4" GEM SCREW LOCK LOCKS

- Fully threaded, key removable in 4 positions
- **COMES WITH 2 KEYS**
- **MAY BE CUT TO DESIRED LENGTH**

\$22.53	L00132
---------	--------

MONORAIL SWITCH LOCK - OLD STYLE LOCKS

- The Medeco unique design provides triple locking action, making the locks virtually pick-proof.
- Fully Threaded
- **COMES WITH 1 KEY**

\$66.78	VA30073
---------	---------

CAM LOCK GEM LOCKS

- **COMES WITH 2 KEYS**

PRICE	PART #	SIZE	DETAILS
\$21.04	L00130	5/8"	Fits most coin boxes
\$23.87	L00134	7/8"	Fits Adams Vac Coin Box

METER PANEL LOCK LOCKS

- Works great on Industrial and Doyle vacs!
- **COMES WITH 1 KEY**

\$16.01	L0104800
---------	----------

VENDER LOCK LOCKS

- For vender coin box & service lid
- **COMES WITH 2 KEYS**

\$11.51	LP21133
---------	---------

GREENWALD LOCKS LOCKS

- **1 KEY INCLUDED**

\$19.30	GR8-55-1	Lock with Long Key No key number needed
\$27.71	GR8-1169	Lock with Short Key No key number needed

BAY ACCESSORIES

LOCKS



COMES WITH 2 KEYS

28/70 DISKUS® LOCK

ABUS LOCKS



- Lock size: 2 $\frac{3}{4}$ "
- Stainless steel construction fights rust and corrosion
- 4-pin cylinder w/anti-pick mushroom pins and bronze spring
- Case hardened shackle extends around the entire case allowing only $\frac{3}{4}$ " exposed
- Shackle diameter - 13/32"
- Great for self storage units
- Shackle opening- $\frac{3}{4}$ "W x $\frac{3}{4}$ "D

\$15.97 L00100

DIFFERENT KEY CODES AVAILABLE - CALL FOR DETAILS



COMES WITH 2 KEYS

24/70 DISKUS® LOCK

ABUS LOCKS



- Lock size: 2 $\frac{3}{4}$ "
- Shackle diameter: 13/32"
- 4-pin cylinder with anti-pick mushroom pins and bronze springs
- Shackle, lock body and all inner components made of non-corrosive stainless steel allowing only $\frac{3}{4}$ " exposed
- Shackle Opening - $\frac{3}{4}$ "W x $\frac{3}{4}$ "D
- Stainless steel - fights against rust and corrosion
- Dust cover over the keyway to keep out harsh elements

\$23.61 L00105

DIFFERENT KEY CODES AVAILABLE - MUST ASSIGN A KEY CODE



COMES WITH 2 KEYS

26/90 DISKUS® LOCK

ABUS LOCKS



- Lock Size - 3 $\frac{5}{8}$ "
- Shackle Diameter - 1/2"
- Hardened chrome shackle
- Stainless steel with nearly 10,000 lbs. of breaking strength
- Welded armor outer shell and laminated steel core inside combined to create a practically invincible lock
- Shackle Opening - 1"W x $\frac{5}{8}$ "D
- 5-pin cylinder with anti-pick mushroom pins and bronze springs
- Improved thicker metal plates to protect from prying and grinding

\$48.40 L00350

DIFFERENT KEY CODES AVAILABLE - MUST ASSIGN A KEY CODE

28/70 DISKUS® LOCK

ABUS LOCKS



- Lock size - 2 $\frac{3}{4}$ "
- Shackle opening- $\frac{3}{4}$ "W x $\frac{3}{4}$ "D
- Shackle diameter - 13/32"
- All stainless steel body: INSIDE & OUT
- Hardened shackle w/minimum exposure
- High security 6-Disc Plus cylinder which offers over 30,000 true key differs
- Hardened steel anti-drill cover to protect the cylinder
- **GREAT FOR VENDING MACHINES**

\$38.41 L00300

70/45 SERIES SOLID BRASS BODY

ABUS LOCKS



- Hardened steel shackle
- Solid brass body and internal components
- Keyed differently or keyed alike

\$10.65 LOA7045

DIFFERENT KEY CODES AVAILABLE - MUST ASSIGN A KEY CODE

55 SERIES SOLID BRASS PADLOCK

ABUS LOCKS



- Great for vac cleanout doors
- 4-pin tumbler security
- Extruded solid brass body
- Chrome plated hardened steel shackle

55/60

DIFFERENT KEY CODES AVAILABLE - MUST ASSIGN A KEY CODE

PRICE	PART #	SIZE	SHACKLE OPENING	SHACKLE DIA.
\$12.63	LOA5560	2 $\frac{3}{8}$ "	1 $\frac{1}{4}$ " W x 1 $\frac{1}{4}$ " D	5/16"

PIN FOR PINLOCK

WILSON BOHANNAN LOCKS



- 1 $\frac{3}{4}$ " long

\$1.47 L00250P



PIN FOR PINLOCK

LOCKS

- Stainless steel
- Threaded

\$17.13 VA40040



THREADED WELD NUT

LOCKS

- For lock pin

\$3.87 VA40041

BAY ACCESSORIES

LOCKS



AMERICAN LOCK™ LOCKS

- Patented shackleless lock
- Nothing exposed
- Solid 1 piece case is reinforced with 9 hardened steel pins
- Shackle size: 5/8"H x 13/32"D

\$29.21 L02000

DIFFERENT KEY CODES AVAILABLE - MUST ASSIGN A KEY CODE

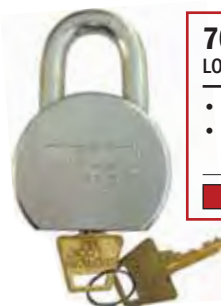

700 SERIES AMERICAN LOCK™ LOCKS



- 2½" x 1½"
- Thick, case hardened, chrome plated solid steel padlock with Baron shackle

\$57.96 LOAM700



SOLID BRASS PINLOCK LOCKS



- Used in coin boxes and vacs
- Pin is 3/8" diameter - Pin sold separately
- One piece solid extruded bronze

\$22.89 L00250 Lock

\$1.47 L00250P Pin

DIFFERENT KEY CODES AVAILABLE - MUST ASSIGN A KEY CODE



CHINROSE® SOLID STEEL PADLOCK CHINROSE LOCKS

- 2½" (65mm) extra security and hardened steel commercial grade globe shape, heavy-weight padlock
- Available in keyed alike & keyed different

\$30.24 LOC9700



CHINROSE® CHROME PLATED PADLOCK CHINROSE LOCKS

- Extra security chrome plated on solid brass padlock with unique dual dimension keys in keyed alike
- Has disc and spacer mechanisms
- Commercial grade
- Available in keyed alike & keyed different

\$19.99 LOC5401 1½" (40mm)

Available in 10 different keyed-alike key cut codes

\$25.00 LOC7501 2" (50mm)

Available in 20 different keyed-alike key cut codes



CHINROSE® GRADE 304 STAINLESS STEEL ROUND DISC LOCK

CHINROSE LOCKS

- 2¾" (70mm)
- Commercial grade 5 pin cylinder with 2 keys
- SECURUS® (CHINROSE®)
- Available in keyed different and keyed alike

\$9.66 LOC5000

DIFFERENT KEY CODES AVAILABLE - MUST ASSIGN A KEY CODE



CHINROSE® PATENED LAMINATED STEEL PADLOCK

CHINROSE LOCKS

- Body width: 2" (50mm)
- Patented laminated steel padlock - heavy weight
- Available in keyed different and keyed alike

\$9.35 LOC1500



CHINROSE® HASP FOR HIDDEN SHACKLE PUCK LOCK

CHINROSE LOCKS

- Hasp of hardened solid state steel for hidden shackle pad lock
- Side opening only

\$30.54 LOC7000-HS

HASP ONLY - LOCK SOLD SEPARATELY - LOC7000



CHINROSE® HEAVY DUTY GATE HASP

CHINROSE LOCKS

- Unique zinc plated solid steel
- Secures 2 gates together or a single gate to a post

\$22.49 LOC5500

BAY ACCESSORIES

SAFES & LOCK ACCESSORIES

STANDARD TWO NIPPLES

PLATED OR STAINLESS STEEL HEAD

10"
\$700
CAPACITY

14"
\$1,200
CAPACITY

18"
\$1,500
CAPACITY

STAINLESS STEEL COIN TRAYS

(STANDARD WITH EACH SAFE)

3/8" HEX UT
WRENCH W/EA SAFE

ROUND STAINLESS STEEL SAFES

SAFES

- Comes with Allen wrench, coin tray & plated head
- Locks NOT included

PRICE	PART #	SIZE	DESCRIPTION
\$550.55	CBSR10	10"	w/plated head
\$819.37	CBSR10S	10"	w/stainless steel head
\$654.73	CBSR14	14"	w/plated head
\$755.37	CBSR14S	14"	w/stainless head
\$596.46	CBSR18	18"	w/plated head
\$810.02	CBSR18S	18"	w/stainless head
\$19.99	CBS315TH		Allen Wrench

PLASTIC COIN TRAYS



ROUND STAINLESS STEEL SAFE HEADS

SAFE PARTS

\$307.54	CBSHPL	7" Plated safe head
\$576.93	CBSHSS	7" Stainless steel safe head
\$324.68	CBSHPLTAB	7" High-security safe heads
\$346.66	CBSHSR	7½" Diameter star replacement
\$607.00	CBSHSSTAB	7" Stainless steel star safe head with lock tab

REPAIR KIT FOR ROUND SAFE HEAD

SAFE PARTS

- Includes spring, ball & cam

\$51.56 CBSKR08

COIN TRAYS

SAFE PARTS

PRICE	PART #	TRAY	SAFE SIZE
\$66.37	CBSCT10	6"	10"
\$69.51	CBSCT14	10"	14"
\$81.79	CBSCT18	14"	18"



SQUARE SAFES

SAFES

- Comes with Allen wrench, coin tray, & lock bar
- All stainless steel construction
- Use L00190 (Medeco Plug Lock)
- 8" x 12"
- \$750.00 capacity
- Locks NOT included

\$724.71 CBS609A



T-HANDLE SQUARE SAFE

SAFES

- 9" x 9" x 12"
- High security safe
- \$1,000.00 capacity
- Medeco T-Handle lock

CALL	CBS3000	Safe
\$274.24	CBS0650	Medeco T-Handle Lock
\$217.69	CBS4001	Coin Tray



LOCK GUARD

LOCKS

- For Buffo & Abus
- Stainless steel construction

\$8.46 LG100



LOCK BARS (1½" WIDE)

SAFE PARTS

PRICE	PART #	DESCRIPTION
\$18.54	CBA9103	Standard - SS 8¼"
\$26.34	CBA9104	Use with Lock guard - Flat SS 8¾"
\$25.99	CBA9105	Monorail style - Flat SS 9½"
\$8.46	LG100	Lock guard (for Buffo and Abus)



SILICONE LUBRICANT

SAFE ACCESSORIES

- 10 oz. can
- Keeps lock mechanisms lubricated

\$6.78 DD04603



PLASTIC COIN FUNNEL

SAFE ACCESSORIES

- Wide section O.D.: 4½"
- Small section I.D.: 1¼"
- Small section O.D.: 1¾"

\$3.99 GS19028

BAY ACCESSORIES

ROTARY SWITCHES



**8 POSITION 2 STACK
ROTARY SWITCH**
SHALLCO SWITCHES



\$45.97 STKR8



**8 POSITION 3 STACK
ROTARY SWITCH**
SHALLCO SWITCHES



\$60.57 STKR83



**10 POSITION 2 STACK
ROTARY SWITCH**
SHALLCO SWITCHES



\$70.50 STKR10



**ELECTRONIC ROTARY SWITCH
SWITCHES**

- Easy replacement - wire the plug once and simply unplug to replace future switches. Knob sold separately

\$101.52	STE8	8 position
\$122.46	STE10	10 position



8 POSITION - 2 STACK
ELECTROSWITCH



- Metal construction
- Double-rotary action with plastic knob
- Included all mounting hardware

\$39.21 ST0209



8 POSITION - 2 STACK
ELECTROSWITCH



- Plastic construction
- Includes all mounting hardware

\$30.63 ST0216P



8 POSITION - 3 STACK
ELECTROSWITCH



- Metal construction
- Double-rotary action with plastic knob
- Included all mounting hardware

\$42.81 ST0210



10 POSITION - 2 STACK
ELECTROSWITCH



- Metal construction
- Double-rotary action with plastic knob
- Included all mounting hardware

\$62.61 ST0215



12 POSITION - 3 STACK
ELECTROSWITCH



- Metal construction
- Double-rotary action with plastic knob
- Included all mounting hardware

\$280.05 ST0213



12 POSITION - 2 STACK
ELECTROSWITCH



- Metal construction
- Double-rotary action with plastic knob
- Included all mounting hardware

\$130.67 ST0212



**12 POSITION
ROTARY SWITCH**
ELECTROSWITCH



- Makes it easy to upgrade your boxes and add more bay functions
 - Direct replacement for both 8 & 10 position.
- *KNOBS NOT INCLUDED

\$195.00 ST0214



HAVE QUESTIONS?

Talk to one of our professional car wash experts live on our website! Just click on the "LIVE CHAT" icon our website to start a conversation TODAY!

BAY ACCESSORIES

ROTARY SWITCHES & METERBOX/COINBOX ACCESSORIES



"Q-C" ROTARY SWITCH

KLEEN-RITE CORP

KLEEN-RITE.com

- Revolutionary design will make changing out rotary switches a breeze! comes complete with wiring harness

\$88.64	STKR8QC	8 position - 2 stack
\$92.37	STKR10QC	10 position - 2 stack



PARTS FOR STKR10QC

KLEEN-RITE CORP

KLEEN-RITE.com

\$54.32	STKR8QC-SWITCH	Switch only for STKR8QC
\$77.59	STKR10QC-SWITC	Switch only for STKR10QC
\$14.78	STKRP378	Male harness for the STKR10QC
\$29.59	STKRP377	Female harness for the STKR10QC
\$31.33	STKRP374	Female harness for the STKR8QC
\$13.58	STKRP375	Male harness for the STKR8QC



STANDARD BLACK KNOB WITH 1 SET SCREW ROTARY KNOBS

\$2.72 STK211



HEAVY DUTY YELLOW KNOB WITH 2 SET SCREWS ROTARY KNOBS

\$4.11 CBK238



HEAVY DUTY BLACK KNOB WITH 2 SET SCREWS ROTARY KNOBS

\$4.52 CBK238BK

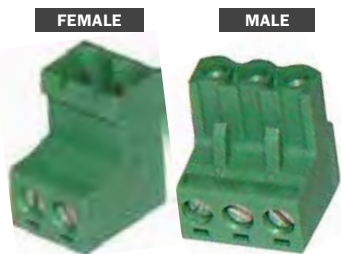

PHOENIX CONNECTORS

BAY ACCESSORIES

MALE CONNECTION		
\$2.30	HSEC14825	2 Pin
\$3.27	HSEC14827	3 Pin
\$13.31	HSEC14823	12 Pin
FEMALE CONNECTION		
\$3.75	HSEC14826	2 Pin
\$5.43	HSEC14828	3 Pin
\$22.03	HSEC14824	12 Pin



MERCURY RELAYS NORMALLY OPEN

BAY ACCESSORIES

\$35.48	RLM24	24V Coil
\$35.48	RLM120	120V Coil



15 SPACE TERMINAL STRIP

BAY ACCESSORIES

\$14.70 GS18727



COIN BOX PILOT LIGHTS

BAY ACCESSORIES

\$3.14	CB0228	24V	Red
\$3.14	CB0228G	24V	Green
\$3.14	CB0228Y	24V	Yellow



SPLIT LOOM

BAY ACCESSORIES

- Ideal for covering wires, hoses, etc.

PRICE	PART #	SIZE	PRICE	PART #	SIZE
\$5.97	SWL240	1/4" SL - 25'	\$10.13	SWL243	3/4" SL - 25'
\$6.71	SWL241	3/8" SL - 25'	\$18.12	SWL244	1" SL - 25'
\$7.83	SWL242	1/2" SL - 25'			



COIN BOX CONTROL WIRE - STRANDED

BAY ACCESSORIES

- 18 Gauge
- 20 Conductor
- Assorted Colors
- 18 Gauge
- 15 Conductor
- Assorted Colors

WI0090	WI0085
\$2.53 Under 100'	\$2.06 Under 100'

FEATURED PRODUCT

KLEEN-RITE COINBOXES

Kleen-Rite coin boxes deliver reliable money acceptance and function control, perfect for self-serve car washes of all sizes. Thanks to a variety of size and option choices, Kleen-Rite coin boxes are suitable for use at new car wash builds or when upgrading older bays!

Each coin box features industry components including Dixmor digital timers, IDX coin acceptors, and Mars bill acceptors. Kleen-Rite's boxes accept coins and tokens as well as \$1, \$5, \$10 and \$20 bills. The boxes are operated by a virtually maintenance-free rotary switch, allowing for up to 10 functions per bay!

COIN BOX STYLE

SHORT HULL



Kleen-Rite short hull coin boxes have a compact footprint and are designed for use with a separate safe. While paper money is held in the unit's bill acceptor, all coins drop through a tube into your hidden safe for extra security.

LONG HULL



Long hull boxes have a separate money drawer underneath the control unit. Coins drop down a chute into this vault, where they remain until emptied. Paper money continues to be collected and held within the unit's bill acceptor.

**SEE PAGE 400 FOR SAFE OPTIONS OR
PAGE 468 FOR VAC IT UP SYSTEMS!**

COIN BOX SECURITY

DELUXE

All-purpose choice suitable for many car wash businesses, especially those that have an attendant or are in low-crime areas. Each box has a durable, 11 gauge 304 stainless steel body and built-in cam locks to deter theft.

HIGH SECURITY

High security coin boxes feature thicker, 7 gauge stainless steel construction. Each box also includes high security plug locks and extra security latches! Kleen-Rite high security coin boxes are a great choice for unattended car washes or high crime areas. While no single product can completely guarantee against theft, a high security coin box is a great deterrent! The added safety features make it harder to access funds, discouraging opportunistic thieves.

Plus, all Kleen-Rite coin boxes have slots to accommodate extra security bars. These bars fit over vulnerable areas such as cam locks and money drawers, then padlock into place for added protection.

SECURITY CONSIDERATIONS

- Is an attendant present at your wash during all business hours?
- Is your business located in a high crime area?
- Do you offer 24 hour a day services?
- Are there security cameras at your wash?

FEATURED PRODUCT

CUSTOM OPTIONS

Kleen-Rite coin boxes may be further upgraded and customized after purchase. Many operators enjoy adding credit card acceptance through the CryptoPay system. This plug-and-play technology integrates directly with Kleen-Rite coin boxes to provide credit card acceptance at an affordable cost. Standalone coin box parts, such as drawers, locks, and bill acceptors, are also available for a completely custom build. Give us a call at 1-800-233-3873 to customize your ideal coin box today!

ADDITIONAL OPTIONS

- Extra function decal sets
- Addition of a push button
- Credit card acceptors
- Different type of coin acceptor

DELUXE

HIGH SECURITY



SHORT HULL DESIGN FOR USE WITH SEPARATE SAFE OR VAC-IT-UP SYSTEM.

DELUXE COIN BOXES

KLEEN-RITE COIN BOXES



- Our deluxe coin boxes make a great upgrade to older car washes. They are also a perfect fit for any new self-serve construction. The boxes come standard with a 10 position rotary selection switch and a Dixmor digital timer with last coin alert feature. The Mars Bill acceptor allows for the acceptance of bills ranging from \$1 to \$20. The MA850 Coin acceptor will take any type of coin, from tokens, quarters and dollar coins.
- **FEATURES:**
 - Dixmor digital timer
 - Last coin alert
 - 10 position "QC" rotary switch
 - IDX MA850 coin acceptor
 - Mars bill acceptor
 - 11 gauge 304 stainless steel plate
- **OTHER OPTIONS:**
 - Choice of coin acceptor
 - Credit card acceptance
 - Different bill acceptor
 - Piezo or mechanical push button

\$2,712.83	CBK5000	Long hull WITH COIN DRAWER
\$2,639.06	CBK6000	Short hull VAULT READY

HIGH SECURITY COIN BOXES

KLEEN-RITE COIN BOXES



- For even more security at your car wash, upgrade to our High Security Meter Boxes. All the standard features of our traditional coin boxes plus added features.
- **FEATURES:**
 - Thicker 7 gauge stainless steel
 - High security plug locks
 - Dixmor digital timer
 - Last coin alert
 - 10 position "QC" rotary switch
- Reinforced timer display housing
- Added security latches
- IDX MA850 coin acceptor
- Mars bill acceptor

\$3,355.41	CBK5000HS	Long Hull
\$2,973.46	CBK6000HS	Short Hull

ADD ON BOX FOR COINCO VANTAGE VALIDATOR

KLEEN-RITE COIN BOXES

CBKCB

ADD ON BOX FOR MARS VALIDATOR

KLEEN-RITE COIN BOXES



ADD ON BOXES FOR MARS AND COINCO VALIDATORS CAN BE USED WITH DELUXE OR HIGH SECURITY COIN BOXES

BAY ACCESSORIES

COIN BOXES



COINBOX SHELL WITH PUCK LOCKS AND FLEX FACEPLATE FOR DIXMOR TIMER

J.E. ADAMS

- 13.00"W x 17.00"H x 8.50"D
- Coin Box Sold Separately (CBA8799-6005A)
- Flex faceplate can accommodate: Dixmor LED7, Coin Mechanism, Bill Validator, CryptoPay or Nayax
- Includes 2 Puck Locks
- No decal
- No internal components

\$1,256.25 CBA19250



UNIVERSAL DIXMOR COIN BOX

J.E. ADAMS

- For CBA19250 coinbox and the 8799 Series Digital Air & Air/Water machines (non-vault ready)
- 6" x 4.75" x 4.5"
- Holds \$224.00

\$47.50 CBA8799-6005A



STAINLESS STEEL VAULT-READY COIN BOX 6058 WITHOUT LOCKS

J.E. ADAMS

- Stainless steel pin lock style stationary pin
- This 10 gauge box is made to be vault-ready and features a face plate with 1½" stainless steel nipple
- 7¼" W x 7½" D x 10½"H

\$273.68 CBA6055



STAINLESS STEEL PINLOCK STYLE COINBOX

J.E. ADAMS

- Stationary pin
- 10 gauge box and face plate, money box & shell
- 7¼"W x 7½"D x 15½"H

\$352.40	CBA6070	with Standard Faceplate
\$352.40	CBA6070D	with Dixmor Faceplate
\$26.34	CBA9104	Stainless Steel Lock Bar
\$25.15	CBD610	Red Decal



STAINLESS STEEL CAM & SCREW LOCK STYLE COIN BOX

J.E. ADAMS

- Cam lock face plate
- 10 gauge stainless steel shell
- 12 gauge face plate
- 7¼"W x 7½"D x 15¼"H

\$341.60	CBA6165	Coinbox
\$26.34	CBA9104	Optional Lock Bar



8204RW COIN BOX REPLACEMENT FOR VACUUMS

J.E. ADAMS

- For CBA6055 & CBA6070 + many J.E. Adams models - see website for complete details
- 5.772"H x 6.938"W x 6.120"D
- Hold 940 quarters or \$235.00

\$95.16 CBA8204

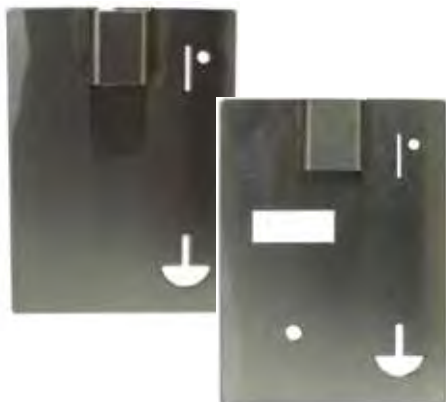

FACEPLATES

J.E. ADAMS

- For CBA6055 & CBA6070

\$66.67	CBA8211	Plain Faceplate
\$58.97	CBA6068	Digital Readout Faceplate



STAINLESS STEEL PUCK LOCK STYLE COIN BOX

J.E. ADAMS

- Features American 2000 puck lock
- Cam lock for faceplate
- 10 gauge stainless steel construction
- 7¼"W x 7½"D x 15¼"H

\$512.39	CBA6175	Standard
\$518.50	CBA6175D	With Dixmor Timer Cutout

CVA6175

BAY ACCESSORIES

METERBOX/COINBOX ACCESSORIES



COIN BOX HEATER ASSEMBLY WITH THERMOSTAT

GINSAN



- 20W & 30W
- Also available for Touchtron 2

\$77.18 GS31070A



COIN BOX HEATER ASSEMBLY WITH THERMOSTAT

GINSAN



- 30W

\$63.46 GS31070



24V/30W COIN BOX HEATER WITH BRACKET

GINSAN

\$70.56 GS18128



THERMOSTAT FOR 24V HEAT TAPE

BAY ACCESSORIES

\$12.18 GS28025



COIN BOX HEAT TAPE WITH ADHESIVE

BAY ACCESSORIES

\$26.01 CB0245 24V - 40W
\$24.09 CB0237 24V - 20W



40 VA - 120 TO 24V TRANSFORMERS

\$32.13 TR0135



RESETTABLE BREAKER

BAY ACCESSORIES

\$7.36	EL0280	3 AMP
\$8.99	EL0281	5 AMP
\$7.19	EL0285	10 AMP
\$8.24	EL0282	12 AMP
\$6.20	EL0283	15 AMP
\$6.62	EL0284	20 AMP



100 VA - 120 TO 240 TO 24V TRANSFORMERS

\$63.01 TR0105

5 AMP FUSE FOR TRANSFORMER

\$6.59 EL0100



CABLE TIES

BAY ACCESSORIES

PRICE	PART #	DESCRIPTION	WT.
\$1.80	TYW4	4" Cable Ties - 100/pk	18 lb
\$3.16	TYW5	5" Cable Ties - 100/pk	30 lb
\$10.38	TYW7E	7" Cable Ties - 100/pk • With Eyelet	50 lbs
\$4.68	TYW8	8" Cable Ties - 100/pk	40 lb

PRICE	PART #	DESCRIPTION	WT.
\$7.50	TYW11	11" Cable Ties - 100/pk	40 lb
\$10.42	TYW14	14" Cable Ties - 100/pk	40 lb
\$13.79	TYW14-120	15" Cable Ties - 100/pk	120 lb
\$22.81	TYW24	24" Cable Ties - 50/pk	175 lb
\$18.75	TYW36	36" Cable Ties - 50/pk	175 lb



INDUSTRIAL GRADE WATERPROOF 2-WAY RADIO WALKIE TALKIE

MIDLAND

Single 2-way IP67 waterproof walkie talkie with 16 channels. Includes charger, rechargeable battery pack, AC wall adapter, belt clip, and owner's manual. Convenient way to improve communication at your business.

- 10 hours of battery life
- Li-On battery pack with rapid charge
- Easy PC programming with 99 frequency selections
- Diecast metal frame for durability
- Monitor, scan and priority scan
- IP67 rating for water and dust protection
- 4 watts of power
- Radio-to-radio cloning
- 142 privacy codes
- Repeater compatible

\$129.99 MB400 Single
\$799.99 MB400X6MC 6-Pack



TWO-WAY RADIO WALKIE TALKIE- 16 CHANNEL

MIDLAND

2-way durable walkie talkie with 16 channels. Includes charger, rechargeable battery pack, AC wall adapter, belt clip, and owner's manual. Convenient way to improve communication at your business.

- 21 hours of battery life
- Rechargeable Li-Ion battery
- Monitor and scan functions
- 56 Business specific frequencies
- Easy PC programmable
- Voice prompted battery alert & channel selection

\$99.99 BR200 Single
\$599.99 BR200X6BGC 6-Pack



BAY ACCESSORIES

LOCTITE®, DYNATEX, & JOHNSON'S



BLUE STICK THREAD LOCKER

LOCTITE **LOCTITE**

- Medium strength anaerobic thread locker offers same locking strength and sealing capabilities as Loctite®'s traditional threadlocking liquid.
- Wax-like stick with a self-feeding applicator
- Well-suited for difficult repairs (like overhead applications)
- Can be applied even if part assembly will occur later - Ideal for volume assembly
- Removable with hand tools

\$11.01 LOC37643



RUBBERIZED UNDERCOATING

LOCTITE

- Seals, protects, insulates
- 16 oz. | 12 per case
- Rubberized for maximum durability

\$108.82 LOC37580



5 OZ. DIELECTRIC GREASE

DYNATEX **Dynatex**

\$18.23 DD49635



8 OZ. COPPER ANTI-SEIZE LUBRICANT WITH BRUSH TOP

LOCTITE **LOCTITE**

- May be used to prevent seizing, corrosion and galling where high temp. conditions exist
- Temperature range: -30° F to 1800° F
- Provides good electrical conductivity

\$10.13 LOC38650



10 OZ. CLEANERS & LUBRICANTS

JOHNSON'S

\$3.46	DD4723	Chain & Cable Lube
\$5.62	DD4607	Air Duster
\$4.07	DD4600	Electronic Cleaner
\$6.78	DD04603	Silicone Lubricant



3 OZ. CLEAR SILICONE GASKET MAKER

DYNATEX

\$6.98 DD49204



3 OZ. BLACK SILICONE GASKET MAKER

DYNATEX

\$6.98 DD49200



THREAD LOCKER

DYNATEX

\$4.57	DD49441	BLUE (med. strength)
\$4.57	DD49451	RED (high strength)



TERMINAL KIT WITH CASE

DYNATEX

Dynatex

110 PIECE KIT INCLUDES:

- (10) 22-14 gauge blue wire nuts
- (5) 18-12 gauge yellow wire nuts
- (10) Crimp style 22-16 gauge wire nuts
- (5) Male disconnects 22-16 gauge red
- (5) Male disconnect 16-14 gauge blue
- (10) Nylon butt connector 22-18 g red
- (10) Nylon butt connector 21-10 g yellow
- (5) Nylon fork #8 16-14 gauge blue
- (5) 22-14 gauge orange wire nuts
- (5) 18-10 gauge red wire nuts
- (10) Crimp style 16-14 gauge wire nuts
- (5) Female disconnects 22-16 gauge red
- (5) Female disconnect 16-14 gauge blue
- (10) Nylon butt connector 16-14 g blue
- (5) Nylon fork #8 22-18 gauge red
- (5) Nylon fork #8 12-10 gauge yellow

\$17.32 DD0110

KLEEN-RITE BOOMS

360° CEILING MOUNT BOOMS

KLEEN-RITE

- 76" in length with stainless steel construction
- Side tap or top tap
- Never grease/No squeak bearings
- Includes boom swivel & boom hose

KLEEN-RITE_{COM}



FLAT PLATE

NEVER NEEDS GREASE



X-BRACE

NEVER NEEDS GREASE



FLAT PLATE - UNIVERSAL BOLT PATTERN

KLEEN-RITE 360° CEILING MOUNT BOOMS

\$525.44 BOKF76A

X-BRACE - STANDARD BOLT PATTERN

KLEEN-RITE 360° CEILING MOUNT BOOMS

\$524.98 BOKX76A

PARTS

KLEEN-RITE 360° CEILING MOUNT BOOMS

\$191.69	BOKF	Flat Plate Base Only
\$18.68	BOKB	Bushing
\$32.05	BOKSP	Spring Only
\$72.41	BOKB88	180° Wall Mount Conversion Bracket

STAINLESS STEEL WALL MOUNT FOAMY BOOM

KLEEN-RITE

- Great for foamy hoses
- 6' long
- 1/2 FPT discharge coupling
- 304 heavy duty
- Stainless steel
- Bracket included

\$326.54	B00150DB	Double Boom
\$165.84	B00150A	Single Boom

BOOM BUMPERS

KLEEN-RITE STAINLESS STEEL WALL MOUNT FOAMY BOOM

\$21.96 BORB

DOUBLE BOOM BRACKET

KLEEN-RITE STAINLESS STEEL WALL MOUNT FOAMY BOOM

\$73.74 B00155D

BOLT-DOWN VIBRATION-DAMPING MOUNT FOR COLEMAN BOOMS

- 1" height x 1.2" diameter x 3.13" base length x 1.75" bade width
- For use with Coleman car wash boom arms
- Black neoprene rubber
- Mounting fasteners not included

\$7.46 51618-50

TAPERED RUBBER STOP FOR COLEMAN BOOMS

KLEEN-RITE

KLEEN-RITE_{COM}

- 1.5" x 1.5"
- For use with Coleman Hanna car wash boom arms
- Durable rubber construction

\$8.04 RS1001-T

360° DOUBLE BOOM

KLEEN-RITE

KLEEN-RITE_{COM}

- Includes 2 booms - booms must be placed 36" apart on center to swing freely
- 2 flat plates

\$1,087.82 BOKF61A

MUST BE PLACED 36" APART



BAY ACCESSORIES

BOOMS



New!

5'1" STAINLESS STEEL Z-BOOM

KLEEN-RITE CORP.

KLEEN-RITE.com

- These 360° car wash booms feature a tough design with stainless steel construction. These Z-Booms are ready to use with self-lubricating ball bearings, high quality swivels and a insulated high pressure hose.
- 4000 PSI • 250° F maximum temperature
- 3/8" NPTF inlets • 3/8" NPTF Outlet

\$679.84 **B00245**



STAINLESS STEEL ADJUSTABLE 360° CEILING BOOM

SUTTNER

SUTTNER

- The unique design allows you to shorten or extend boom to fit the size of car wash bays and lengthen for longer reach
- 2-ball bearings axle - permanently lubricated
- Stainless steel boom • High pressure hose with spring
- 3000 PSI • 250° F maximum temperature
- Adjusts from 42" - 72" • 3/8" MNPT outlet

CALL **B00255**



ROUND BASE

180° WALL MOUNT

MAXI-FLEX CEILING & WALL BOOM

MIGHTY CLEAN BOOMS

- Constructed of space age stainless steel alloy making it virtually indestructible with the ultimate in flexibility
- Stainless steel boom rod that can be pulled down 45° and will "flex" back without damage
- Comes standard with repairable quality ball bearing swivel and high quality trunnion bearing in base
- Two-piece construction for easy installation
- Mounting base designed to retrofit common hole patterns
- Heavy manifold attachments make hose unable to be pulled off
- Inlet ports accessible from either top or side of boom base
- Available in 5½ ft. • Ports are 3/8" FPT • Maximum 160° F

\$270.55	B00170	180° Wall Mount
\$270.73	B00175	Round Base Maxi-Flex

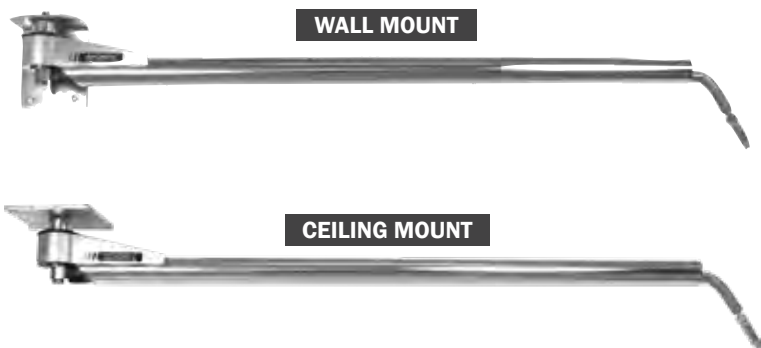

WALL MOUNT

CEILING MOUNT

P-SERIES CAR WASH BOOMS

MOSMATIC BOOMS

mosmatic

- Ideal for use in self-service carwash systems
- High quality stainless steel tubing which guarantees strength and stability
- Max Pressure - 4000 PSI

180° WALL	360° CEILING	DESCRIPTION
BOM68509	BOM66009	4'9" Stainless Steel Polished
BOM68519	BOM66019	5'3" Stainless Steel Polished
BOM68529	BOM66029	5'9" Stainless Steel Polished
BOM68539	BOM66039	6'3" Stainless Steel Polished
BOM68549	BOM66049	6'9" Stainless Steel Polished
BOM68559	BOM66059	7'5" Stainless Steel Polished
BOM68569	BOM66069	8'2" Stainless Steel Polished
BOM68579	BOM66079	9' Stainless Steel Polished
BOM68589	BOM66089	9'10" Stainless Steel Polished

CALL FOR PRICES

BAY ACCESSORIES



BOOMS

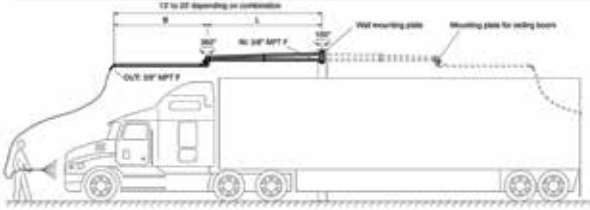

WALL BOOM EXTENSION

USE WITH MOSMATIC P SERIES CEILING BOOM

- Ideal for use in truck & trailer wash bays
- Made of high-quality stainless steel tubing which guarantees strength and stability
- DKP needed along with adaptor fitting BOMP51129

BOMP51129	Fitting: G1/4" M x 3/8" NPTF
BOM60522	6'8" Stainless Steel Polished
BOM60532	8'2" Stainless Steel Polished

BOM60542	9'10" Stainless Steel Polished
BOM60983	14'9" Stainless Steel Polished

CALL FOR PRICES

CALL FOR PRICES

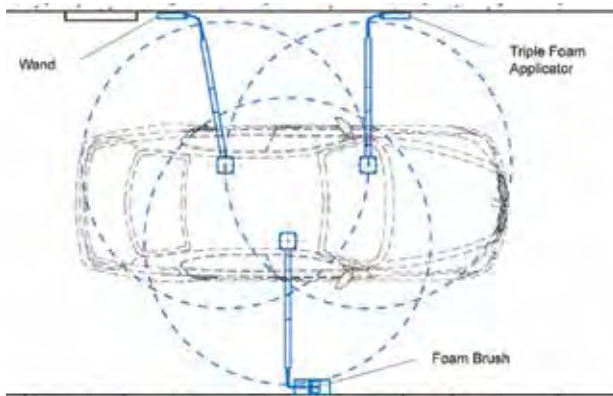
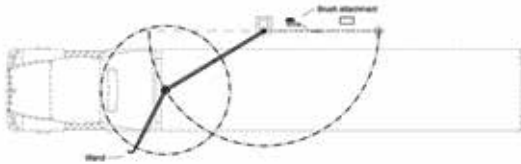

DKZ 3 SERIES CEILING BOOM

MOSMATIC BOOMS

- This self-service car wash solution includes a patented Z-Series ceiling boom that allows continuous 360° rotation for the high pressure wand or foam brush. The installation of an optional positioning device guarantees a designated parking position for the ceiling boom.

BOM65009	4'9" Stainless Steel Polished
BOM65019	5'1" Stainless Steel Polished

BOM65029	5'5" Stainless Steel Polished
BOM65039	5'9" Stainless Steel Polished

CALL FOR PRICES

CALL FOR PRICES



DUAL CEILING BOOM

MOSMATIC BOOMS



- Ready for installation, integrated "SMART-Tech®" swivels, axle with "Perma-lube" ball bearings, insulated high pressure hose. Ideal for prep area.

BOM67409	4'9" x 5'3"
BOM67419	5'3" x 5'9"
BOM67429	5'9" x 6'3"

BOM67439	6'3" - 6'9"
BOM67449	6'9" - 7'5"
BOM67459	7'5" - 8'2"

CALL FOR PRICES

CALL FOR PRICES

CEILING MOUNT Z BOOM

BOM65209	4'9"
BOM65219	5'1"
BOM65229	5'5"
BOM65239	5'9"

CEILING MOUNT BOOM

BOM66209	4'9"	BOM66259	7'5"
BOM66219	5'3"	BOM66269	8'2"
BOM66229	5'9"	BOM66279	9'
BOM66239	6'3"	BOM66289	9'10"
BOM66249	6'9"	CALL FOR PRICES	

DUAL CEILING MOUNT BOOM

BOM67609	4'9"/5'3"
BOM67619	5'3"/5'9"
BOM67629	5'9"/6'3"
BOM67639	6'3"/6'9"
BOM67649	6'9"/7'5"
BOM67659	7'5"/8'2"

CONTROL BOX FOR LED BOOMS

Includes: controller, power supply, remote control, receiver with housing.
For 2 booms max.

BOMP65975

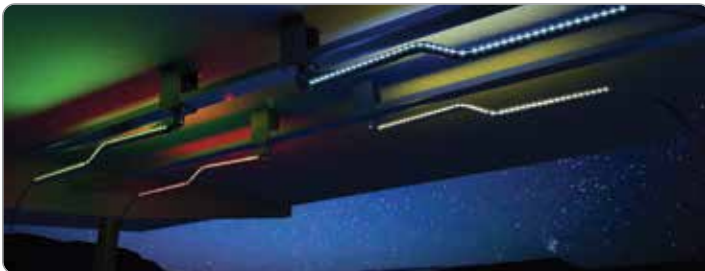

BRASS BREAK-AWAY FITTING

MOSMATIC BOOMS

- Max PSI: 5800 PSI
- Inlet/Outlet: 3/8"

\$4.37 **BOMP19009**

BAY ACCESSORIES

BOOMS



MAGNETIC POSITION DEVICE
MOSMATIC BOOMS



• Available for all Mosmatic single pipe series ceiling booms. Specially designed to "park" the boom in the position you assigned. Easily installed and can be added to previously installed booms. An optional positioning device guarantees a designated parking position for the ceiling boom.

CALL BOMP65911



DROP DOWN STEMS
MOSMATIC BOOMS



• Drop down stems lower booms up to a total of 20" from the ceiling. Single boom use only

BOMP902753	2" Extension
BOMP902752	4" Extension
BOMP901875	8" Extension

CALL FOR PRICES



OPTIONAL MOUNTING BRACKET
MOSMATIC BOOMS



• Install two Mosmatic DKZ stainless steel ceiling booms on one center beam
• 47" in length

CALL BOMP65903

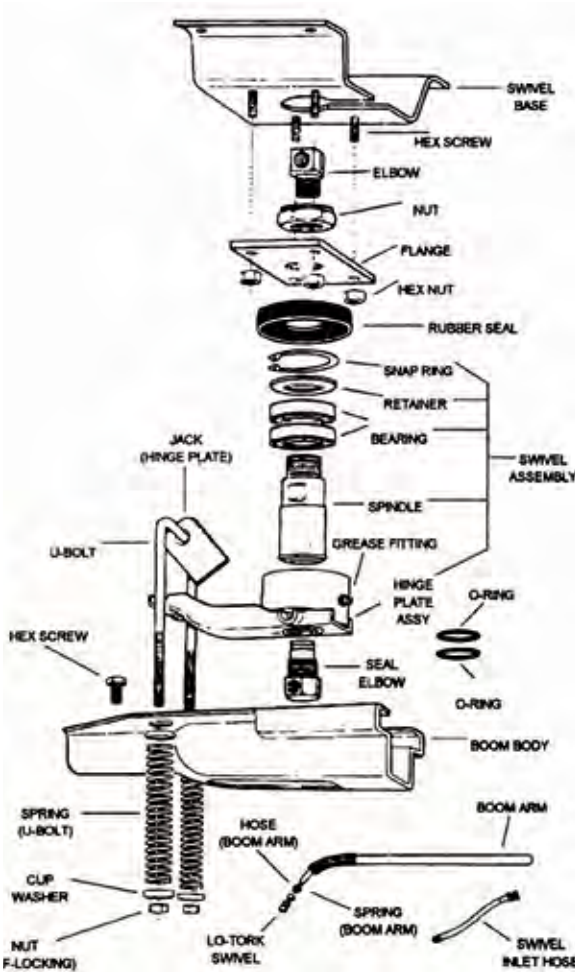

COMPLETE BOOM ASSEMBLY

ZIERDEN COMPANY



• The Zierden Boom is ideal for heavy commercial use in coin-operated car washes, service bays, and in car and truck fleet cleaning departments. The boom permits 360° of free and easy rotation around a vehicle in an 11 foot diameter. Heavy gauge steel mounting base, non-corrosive metal internal parts and double ram ball bearings for effortless boom swing. Boom is 5 feet. Extensions are also available.

\$2.50	B00064	Back Up Ring	\$17.65	B00079	Cartridge Collar/Flange
\$26.11	B00065	Elbow Seal	\$9.85	B00081	U Bolt
\$1.93	B00066	O Ring/Elbow Seal	\$5.89	B00082	U Bolt Spring
\$1.76	B00067	Retainer	\$0.82	B00083	Cup Washers
\$1.55	B00068	Snap Ring	\$0.75	B00084	Nuts
\$88.05	B00072	Boom Bodies	\$1.89	B00085	Jacks
\$25.89	B00074	5' Pipe	\$40.06	B00086	Hinge Plate/ Old style
\$7.05	B00075	Spring (for pipe)	\$101.26	B00089	Swivel & Hinge Plate Assembly
\$2.25	B00076	Locknut 1" (Thin)	\$28.76	B00091	Boom Arm With Spring
\$10.54	B00077	Mounting Flange (small)	\$1.93	B00092	O Ring (Yellow Mark)
\$46.34	B00078	Swivel Base Assembly Rectangular (NEWER STYLE)	\$7.99	B00093	Single Row Bearing
			\$35.05	B00094	Spindle



COMPLETE BOOM ASSEMBLY
ZIERDEN COMPANY

\$320.36 B00050A



CONVERSION KIT
ZIERDEN COMPANY

• For converting Model 203 sealed cartridge boom to the Model 204 easy boom service

\$171.04 B00070



360° OVERHEAD SWIVEL CARTRIDGE
ZIERDEN COMPANY

NON-REBUILDABLE			FACTORY REBUILDABLE		
\$103.73	SW2500	1/4" Side	\$110.70	SW2300SS	3/8"
\$103.73	SW2700	3/8" Side			
\$103.73	SW2900	3/8" TT			

SIGNS • BANNERS • DECALS

FLAGS

12' FEATHER FLAGS

FLAGS

• Nylon • MESSAGE READS ON ONE SIDE • 13' x 2.5' (with stand) • 12' x 2.5' (without stand) • FLAG STANDS/POLES SOLD SEPARATELY

\$26.60



CWF12109 CWF12110 CWF12111 CWF12113 CWF12041 CWF12 CWF12330 CWF12028 CWF12104 CWF12105



CWF12107 CWF12106 CWF12298 CWF12071 CWF12072 CWF12112 CWF12320 CWF12331 CWF12036 CWF12301

HARDWARE FOR 12' FEATHER FLAGS



CWF12263 CWF12355 PTW330 \$39.99



7 PIECE POLE KIT - X-STAND
FLAGS

\$69.99 CWF1702



5 PIECE POLE KIT - GROUND SPIKE
FLAGS

\$49.99 CWF50212

DON'T FORGET YOUR FLAG STAND.

STANDS MUST BE PURCHASED IN ORDER TO RECEIVE A POLE!

FLAG STANDS ARE SOLD SEPARATELY!

SIGNS • BANNERS • DECALS

FLAGS

5' FEATHER FLAGS FLAGS

• Nylon • MESSAGE READS ON ONE SIDE • 7' x 2.5' (with stand) • 5' x 2.5' (without stand) • FLAG STANDS/POLES SOLD SEPARATELY

\$17.99



CWF50109



CWF50041



CWF50045



CWF50031



CWF50073



CWF50032



CWF50071



CWF50072



STRAIGHT FLAG WALL MOUNT FOR 5' FLAGS

FLAGS

\$31.50 CWF0558



FLAG FLOOR MOUNT FOR 5' FLAGS

FLAGS

\$31.50 CWF0557



ANGLE FLAG WALL MOUNT FOR 5' FLAGS

FLAGS

\$31.50 CWF0559



SMALL POLE SET WITH X-STAND

FLAGS

\$49.99 CWF0556



SMALL POLE SET WITH GROUND SPIKE

FLAGS

\$35.50 CWF0555

HARDWARE FOR 5' FEATHER FLAGS

FLUTTER ADVERTISING STANDS OUT FROM THE CLUTTERED BUSY STREETS.

Draw attention to your car wash business with these eye-catching flags. These banner flags are for outdoor use and stand up well to environmental elements. Flag lettering is printed on one side with the reverse image showing through the other side for opposing traffic. Aluminum poles make it easy to transport and carry, while keeping the price more affordable.



PENNANTS

OUTDOOR HEAVY DUTY PENNANT STRINGS

BANNERS

- 100' long string of pennants
- Each pennant flag measures 12" x 18"
- Pennant flags are made of 8 mil commercial grade plastic
- 48 pennant flags per string, double stitched 3/4" stringer ties easily and securely fastens to any pole, eye hook, etc
- The perfect way to grab potential customers' attention when they're passing by. Highlight your car wash, gas station, car dealership, or store. Perfect for grand openings, holidays, and other special events!
- Can withstand the demands of outdoor use, but lifespan depends heavily on weather conditions. Under constant use, expect these to last 1-4 months before beginning to show some wear.



RED, SILVER & BLUE

OUTDOOR HEAVY DUTY PENNANT STRINGS

\$44.00 RT33000



RED, WHITE & BLUE

OUTDOOR HEAVY DUTY PENNANT STRINGS

\$44.00 RT33010



RED

OUTDOOR HEAVY DUTY PENNANT STRINGS

\$44.00 RT33020



MULTICOLORED

OUTDOOR HEAVY DUTY PENNANT STRINGS

\$44.00 RT33030



BLUE

OUTDOOR HEAVY DUTY PENNANT STRINGS

\$44.00 RT33040

SIGNS • BANNERS • DECALS

INFLATABLES



10' AIR DANCERS®

LOOKOURWAY

• Nylon • 11' Tall (with blower - pictured) • 12" Diameter

PRICE	DANCER ONLY	DESCRIPTION
\$63.99	CWI200112	Red
\$63.99	CWI200113	Blue
\$63.99	CWI200114	Yellow
\$63.99	CWI200115	Orange
\$63.99	CWI200116	Green
\$63.99	CWI200135	American Flag

AIR DANCER® AND AIR WAVER® BLOWER ONLY

LOOKOURWAY

\$147.37	CWI300108	-	Compatible with 10' sky dancers and 6' air wavers
\$178.95	CWI311034	Water Resistant	

20' AIR DANCER® BLOWER ONLY

LOOKOURWAY

\$205.13	CWI300042	
----------	-----------	--

20' AIR DANCER® WEATHER RESISTANT BLOWER ONLY

LOOKOURWAY

\$225.64	CWI311055	
----------	-----------	--

Check out more Air Dancers® online!



New!

20' AIR DANCERS®

LOOKOURWAY

• Nylon • 20' Tall (with blower - pictured) • 18" Diameter

PRICE	DANCER ONLY	DESCRIPTION
\$136.79	CWI180064	Santa Claus
\$136.79	CWI180072	Holiday Elf
\$136.79	CWI180063	Snowman
\$136.79	CWI180059	Monster
\$136.79	CWI180062	Spooky Skeleton
\$89.99	CWI200127	Red
\$89.99	CWI200011	Blue
\$89.99	CWI200010	Yellow
\$89.99	CWI200012	Red, White & Blue
\$184.99	CWI200074	Blue Car Wash
\$124.99	CWI200070	American Flag

MESSAGE BOARDS AND SIGNS



SIGNICADE MESSAGE SIGNS

- Sign stays securely in place.
- No maintenance – all plastic.
- No tape, Velcro, or screws needed.
- Can be internally weighted for stability
- Hinges lock in open position.
- Stand Dimensions 46.375" H x 27.125" W
- Weight 20 lbs.

\$256.70 **SI0800M**



KLEEN-RITE ONLINE VIDEO LIBRARY

Did you know that we have an extensive library of videos on our website to help you with your business? We have helpful How-To videos where we take you step by step through repairs and troubleshooting tips. We also have many videos highlighting new products and features.

VISIT OUR VIDEO LIBRARY TODAY!
KLEENRITE.COM

DISCLAIMER SIGNS

- 20" x 36" Polycarbonate
- Alleviate potential frustration and danger with clearly marked car wash signs. Armed with proper instructions, customers will feel relaxed and confident at your car wash, and they'll get the best wash results, too!



RED & GRAY DISCLAIMER SIGNS

\$50.08 **SIKR305**



BLUE & WHITE DISCLAIMER SIGNS

\$50.08 **SIKR300**

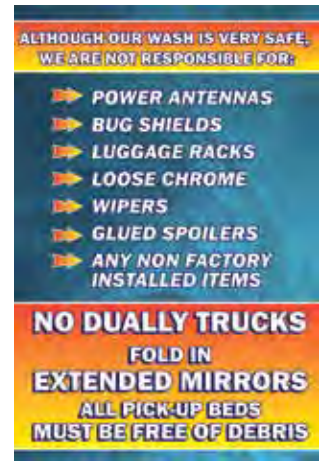

BLUE & ORANGE DISCLAIMER SIGNS

\$50.08 **SIKR310**



FOLDABLE DOUBLE SIDED SIGN

AHEARN

- Advertise your unlimited wash program, towel return, bug remover, and special pricing with these folding signs
- Full color, A-Frame, customizable graphics
- **INCLUDES:** Fillable sand bag and stake
- **CUSTOMIZATION OPTIONS:**
 - Unlimited Wash - Name of wash, price per month, and products featured
 - Towel Return - Name of wash and towel bin color
 - Customer Appreciation - Price

CALL	FOGO-JUN	Unlimited Wash Plans
	FOGO-FTO	Please Return Towels
	FOGO-BSC	Bug Scrub
	FOGO-GAP	Customer Appreciation

Ahearn Signs

SIGNS • BANNERS • DECALS

SIGN HOLDERS



WINDMASTER CURB SIGN STAND

SIGN HOLDERS

- Holds 28" x 44" Signs (**SOLD SEPARATELY**)
- Snap-in frame with spring loaded stand for wind and impact resistance
- Easy assembly leg brackets
- Fluted polypropylene backing
- Includes legs and cross bars

\$270.91 CH2002

WINDMASTER HARDWARE REPLACEMENT KIT

SIGN HOLDERS

- Includes 2 Springs, 2 Replacement legs & 1 Cross Bar

\$78.26 TSSRPW1



PORTABLE WINDMASTER SIGN HOLDER

SIGN HOLDERS

- Snap-in frame for 28" x 44" signs
- Anodized aluminum construction
- Spring loaded stand for impact and wind resistance
- Simple assembly leg brackets
- Convenient divider
- Includes legs and cross bars

\$383.76 CH2002-T

SIGNS SOLD SEPARATELY

SIGNS SOLD SEPARATELY



WINDMASTER SNAP FRAME

SIGN HOLDERS

- Easy snap open side rails makes for easy sign changes. Holds 28" x 44" signs (**SOLD SEPARATELY**)
- Satin aluminum frame, with rounded corners
- Plastic base has two built-in wheels - can be filled with dry sand
- Heavy-duty coil springs resist strong winds
- PVC Clear Protective Cover, protects graphics
- Enclosed top and sides for moisture resistance
- Use indoors and out
- Tool free assembly

\$310.03 WMS2000

SIGNS SOLD SEPARATELY



WINDMASTER SIGN HOLDER WITH WHEELS

SIGN HOLDERS

- Holds 28" x 44" signs (**SOLD SEPARATELY**)
- Anodized aluminum construction
- Spring loaded stand for impact and wind resistance
- Simple assembly leg brackets
- Convenient divider
- Includes wheel accessory, legs, and cross bars

\$255.69 CH2002W

WHEEL ASSEMBLY REPLACEMENT

SIGN HOLDERS

\$34.92 CHPWK

PLASTICAIDE®

SIGNICAIDE SIGNS

SIGN HOLDERS

DUAL SIDED SIGNICAIDE PLASTIC SIGN HOLDER

SIGN HOLDERS

- Quick-Change signs easily slide in and out. (**SIGNS SOLD SEPARATELY**)
- Sign stays securely in place.
- No maintenance - all plastic.
- No tape, Velcro, or screws needed.
- **HOLE IN EACH LEG TO FILL WITH DRY SAND FOR ADDED STABILITY.**
- Hinges lock in open position.
- Stand Dimensions: 46 3/8" H x 27 1/8" W
- Sign Size: 24" x 36"
- Weight 20 lbs.

\$89.74 SI0800

- Reusable, lightweight 24" x 36" signs
- Slides securely into Signicade plastic sign holder (**SI0800**)
- No clips, adhesives or fasteners needed - use again and again!

\$36.51

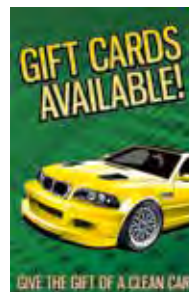

SI0800S14

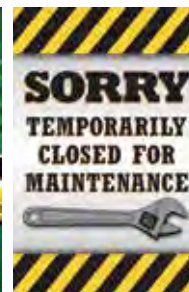

SI0800S10

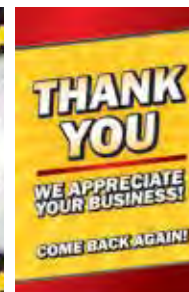

SI0800S17

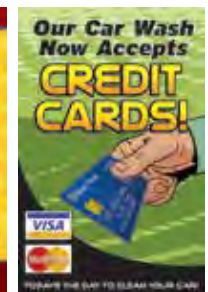

SI0800S08

SIGNS • BANNERS • DECALS

WINDMASTER SIGNS

28" W x 44" H WINDMASTERS - SIGN INSERT ONLY
SIGNS

\$62.12



WMS140



WMS135



WMS137



WMS150



WMS152BL

BILINGUAL



WMS155



WMS120



WMS122



WMS190



WMS170

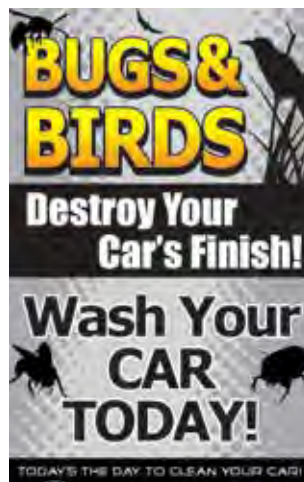

WMS125



WMS015

SIGNS • BANNERS • DECALS

WINDMASTER SIGNS

28" W x 44" H WINDMASTERS - SIGN INSERT ONLY
SIGNS

\$62.12



WMS145

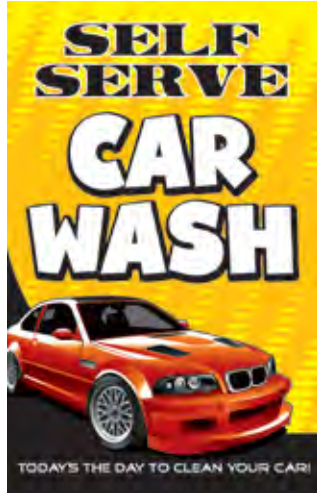

WMS110



\$66.99 PTW145



WMS130



WMS105

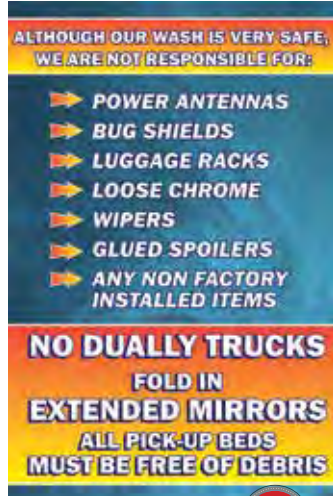

WMS185



WMS180



WMS175



WMS030



WMS165



WMS167

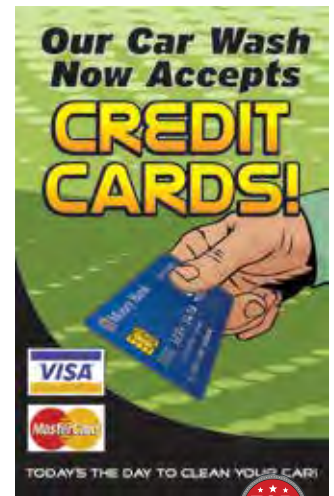

WMS115



SIGNS • BANNERS • DECALS

WINDMASTER SIGNS

28" W x 44" H WINDMASTERS - SIGN INSERT ONLY
SIGNS

\$62.12



WMS100 **TOP SELLER!**



WMS100BL **BILINGUAL**



WMS160 **TOP SELLER!**



WMS160BL **BILINGUAL**



WMS210



WMS200

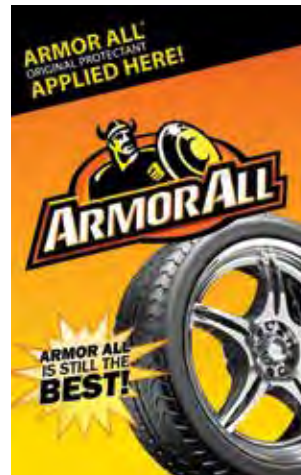

WMS700

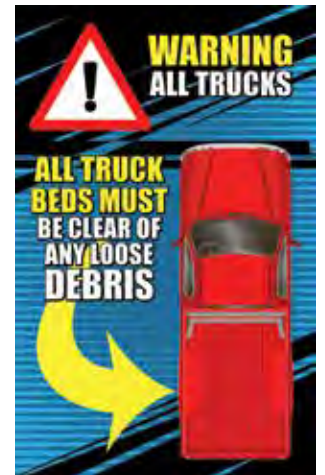

WMS010



WMS020



WMS020BL **BILINGUAL**



WMS005



WMS227

SIGNS • BANNERS • DECALS

WINDMASTER SIGNS

28" W x 44" H WINDMASTERS - SIGN INSERT ONLY
SIGNS

\$66.45



WMS230



WMS540



WMS510



WMS220



WMS520

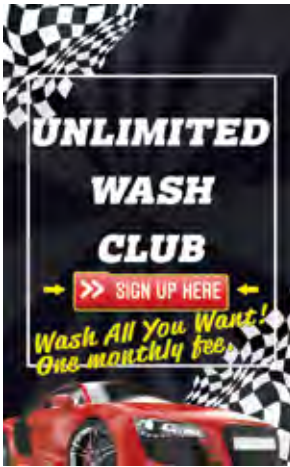

WMS025



WMS025BL BILINGUAL



WMS102

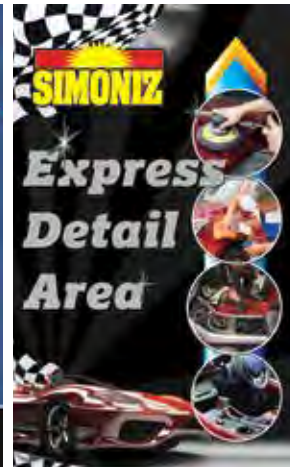

WMS222



WMS222BL BILINGUAL



WMS530



WMS550



WMS195



WMS320



WMS310

SIGNS • BANNERS • DECALS

TSS CAR WASH SIGNS



ILLUMINATED SLIM VERTICAL MENU

TSS SIGNS

- Prices of your car wash services applied in removable vinyl film - **EASY TO CHANGE**
- 36" W x 72" H vertical menu
- 18" ground clearance
- Baked enamel aluminum with stainless steel hardware and high-impact plastic face
- 100 - 240VAC / 2.4 AMP
- Illuminated with ultra bright LED clusters

TSSMS3X6

CUSTOMIZE WITH YOUR DESIGN AND MESSAGE

MUST SPECIFY DESIGN WHEN ORDERING!



ILLUMINATED DIE CUT MENU

TSS SIGNS

- Every aspect of this menu is customized to your wash theme, from the header down to the shapes and sizes of the packages.
- Aluminum body and a high-impact plastic face
- Dimensions up to : 40" W x 896" H
- Voltage/Amperage: 100 - 240VAC / 2.4 AMP
- Background graphics are illuminated with ultra bright LED clusters

TSSM4X8DCL

CUSTOMIZE WITH YOUR DESIGN AND MESSAGE

MUST SPECIFY DESIGN, MESSAGE, ICONS, WORDING & PRICING WHEN ORDERING!



ILLUMINATED IMENU™ 2.0

TSS SIGNS

- Slim, Die Cut, Pedestal mount
- 1" ground clearance
- Dimensions: 40" W x 96" H
- Voltage/Amperage: 100 - 240VAC / 2.4 AMP
- Aluminum body with high-impact plastic face
- Illuminated with ultra bright LED clusters
- **CHOOSE DESIGN**
- **SPECIFY WORDING / CUSTOM DESIGN**
- **CHOOSE ICON STYLE OR WORDING ONLY STYLE**
- **CHOOSE BAKED ENAMEL BODY COLOR:** Clear Anodized (standard), Black, Blue, Green, Red, White, Yellow

TSSIMENU2S

MUST SPECIFY DESIGN WHEN ORDERING!



ILLUMINATED IMENU

TSS SIGNS

- Pedestal mount
- 24" ground clearance
- Dimensions: 30" W x 72" H x 4" D
- Voltage/Amperage: 100 - 240VAC / 2.4 AMP
- Illuminated with ultra bright LED clusters
- Aluminum body with baked enamel and a high-impact plastic face
- **SPECIFY WORDING / CUSTOM DESIGN**
- **CHOOSE ICON STYLE OR WORDING ONLY STYLE**
- **CHOOSE BAKED ENAMEL BODY COLOR:** Clear Anodized (standard), Black, Blue, Green, Red, White, Yellow

TSSIMENU

MUST SPECIFY DESIGN WHEN ORDERING!



JACKPOT FIXTURE

TSS SIGNS

- Bright, eye-catching graphics
- LED puck border
- Choose design
- Pedestal mounts require 32" ground clearance
- **CHOOSE LED PUCK TYPE & COLOR**
- **TYPES:** Flashing or Spinning
- **COLORS:** Multi-Color, Amber, Blue, Green, Red, White
- **CHOOSE BAKED ENAMEL BODY COLOR:** Clear Anodized (standard), Black, Blue, Green, Red, White, Yellow

ILLUMINATED BACKGROUND

TSSJPOTSI	Single Color, Swivel Mount
TSSJPOTSPI	Single Color, Pedestal Mount
TSSJPOTSMPI	Multi-Color, Swivel Mount
TSSJPOTSMPI	Multi-Color, Pedestal Mount

NON-ILLUMINATED BACKGROUND

TSSJPOTS	Single Color, Swivel Mount
TSSJPOTSP	Single Color, Pedestal Mount
TSSJPOTSMS	Multi-Color, Swivel Mount
TSSJPOTSMP	Multi-Color, Pedestal Mount

MUST SPECIFY DESIGN WHEN ORDERING!



2 SECTION TRAFFIC COMMANDER - SWIVEL MOUNT

TSS TRAFFIC LIGHTS FOR AUTOMATICS

- Comes with standard stop (with red strobe, without X) / go forward (with green strobe)
- Design as shown
- Clear anodized baked enamel body

CALL

TSS2STCS
TSS2STCS-C

Standard Model
Customizable Model

2 SECTION TRAFFIC COMMANDER - PEDESTAL MOUNT

TSS TRAFFIC LIGHTS FOR AUTOMATICS

- Comes with standard stop (with red strobe, without X)/go forward (with green strobe)
- Illuminated pedestal (mirrors active strobe color) with 45" ground clearance
- Design as shown
- Clear anodized baked enamel body

CALL

TSS2STCP
TSS2STCP-C

Standard Model
Customizable Model

MUST SPECIFY DESIGN, BODY COLOR, LED STROBE COLORS AND ANIMATION STROBES WHEN ORDERING

SIGNS • BANNERS • DECALS



TSS CAR WASH SIGNS

TSS SIGNS AND MENUS COME IN A VARIETY OF DIFFERENT DESIGNS!

There are a multitude of different pre-made designs available for your TSS sign when you order! Check online or with your order-taker to take a look at all the different eye-catching designs available to you.

TSS signs and menus are the perfect way to make your car wash stand out from the competition! A great investment to liven up your wash bay stations.



SLIM 3 SECTION FIXTURE WITH STROBES

TSS SIGNS

- The background of the graphics is illuminated with ultra-bright LED clusters
- **MUST SPECIFY DESIGN WHEN ORDERING**
- **MUST SPECIFY STROBE COLORS WHEN ORDERING:** (Green, Red, Amber, Blue or White)
- **MUST SPECIFY BODY COLOR WHEN ORDERING:** (Gray, Black, Blue, Green, Red, White, Yellow)
- **ANIMATED STROBE (OPTIONS AT \$10 ADDITIONAL COST EACH):** Red X, Blue Arrow, Amber Arrow, Red Arrow, Green Arrow
- Baked enamel aluminum with stainless steel hardware and a high impact-plastic face
- 18" W x 30" H x 4" D
- 100 - 240 VAC / 1.8 AMP per section
- Illuminated with ultra bright LED clusters

TSSTR3S	Swivel Mount
TSSTR3P	Pedestal Mount



FLASHING LUMINOUS BOX

TSS SIGNS

- Illuminated with ultra bright LED clusters
- 20" W x 24" H x 3" D
- 120 VAC
- Features built-in flasher

TSSTLUMRS	Swivel Mount
TSSTLUMRP	Pedestal Mount

CUSTOMIZE WITH YOUR DESIGN AND MESSAGE

MUST SPECIFY DESIGN WHEN ORDERING!



FLASHING LUMINOUS ROUND FIXTURE

TSS SIGNS

- Illuminated with ultra bright LED clusters
- 18" W x 3" D
- Baked enamel aluminum body with high-impact plastic face
- 100 - 240 VAC/1.2 AMP

TSSRS	Swivel Mount
TSSRP	Pedestal Mount

CUSTOMIZE WITH YOUR DESIGN AND MESSAGE

MUST SPECIFY DESIGN WHEN ORDERING!



INSTRUCTIONAL CABINET WITH STROBES

TSS SIGNS

- The entire left side of the fixture will remain lit and the strobes will alternate down from top to bottom
- **MUST SPECIFY STROBE COLORS WHEN ORDERING:** (Green, Red, Amber, Blue or White)
- **MUST SPECIFY BODY COLOR WHEN ORDERING:** (Black, Blue, Green, Red, White, Yellow, Clear Anodized)
- Baked enamel aluminum with stainless steel hardware and a high impact-plastic face
- 24" W x 48" H x 4" D
- 100 - 240 VAC / 1.8 AMP
- Illuminated with ultra bright LED clusters

TSSTSIFNS	Swivel Mount
TSSTSIFNP	Pedestal Mount



FLASHING APEX FIXTURE

TSS SIGNS

- Baked black enamel aluminum body with high-impact plastic face
- 100 - 240 VAC/1.2 AMP
- 4ft Tall fixture is: 48" H x 12½" W x 5½" D
- 5ft Tall fixture is: 60" H x 12½" W x 5½" D
- Energy efficient Ultra Bright LED clusters

4' FIXTURES		5' FIXTURES	
TSSA4S	Swivel	TSSA5S	Swivel
TSSA4P	Pedestal	TSSA5P	Pedestal

CUSTOMIZE WITH YOUR DESIGN AND MESSAGE

MUST SPECIFY DESIGN WHEN ORDERING!

SIGNS • BANNERS • DECALS

OUTDOOR BANNERS

8' W x 3' H OUTDOOR BANNERS BANNERS

• Heavy duty for long-term outdoor display. Comes standard with mounting grommets.

\$113.21



BANNER3801



BANNER3809



BANNER3802



BANNER3812



BANNER3812BL **BILINGUAL**



BANNER3803



BANNER3811



BANNER3804



BANNER3805



BANNER3806



BANNER3813



BANNER3813BL **BILINGUAL**

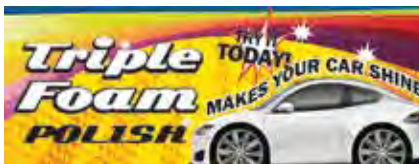

BANNER3807



BANNER3814

14' W x 2.5' H OUTDOOR BANNERS BANNERS

• Heavy duty for long-term outdoor display. Comes standard with mounting grommets.

\$277.78



BANNER01



BANNER02



BANNER03



PTW141

SIGNS • BANNERS • DECALS

INSTRUCTIONAL SIGNS

12" X 12" DELUXE BAY SIGNS

• Polystyrene construction

\$14.20



SIKR084



SIKR081



SIKR083



SIKR082



SIKR080



SIKR086



SIKR085

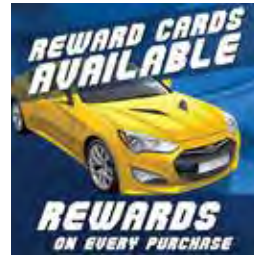

SIKR095



SIKR096

12" x 12" POLYSTYRENE

• Credit card signs

\$14.20

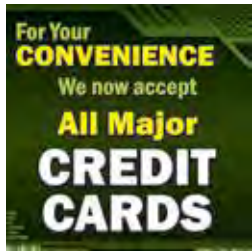

SIKR073

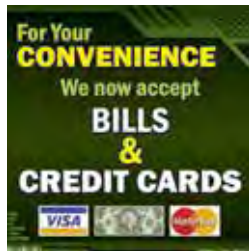

SIKR141



SIKR075

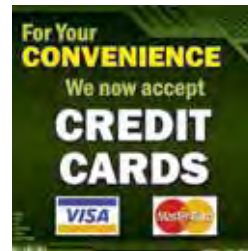

SIKR074



SIKR076

12" x 12" POLYSTYRENE

• Checkered sign series

\$14.20



SIKR405



SIKR403



SIKR400



SIKR401



SIKR404



SIKR407



SIKR406



SIKR402

SIGNS • BANNERS • DECALS

INSTRUCTIONAL SIGNS

9" X 16" POLYSTYRENE

• Graphic sign series

\$12.33



SIKR421



SIKR424



SIKR422



SIKR425



SIKR427



SIKR423



SIKR420



SIKR426



SIKR428

NEW LOOK!

Kleen-Rite strives to give our customers exactly what we want - that's why we've given some of our signs a new look. Our popular message signs have a bold, fresh look to help you guide your customers through the wash process.

SIGNAGE FOR CHANGERS



20½" x 15" POLYSTYRENE CHANGER SIGN
INSTRUCTIONAL SIGNS

\$17.25 SIKR155



9" x 16" POLYSTYRENE TOKENS ONLY SIGN
INSTRUCTIONAL SIGNS

\$12.33 SIKR039N



24" x 18" POLYSTYRENE BILL CHANGER SIGN
INSTRUCTIONAL SIGNS

\$11.99 SI0120

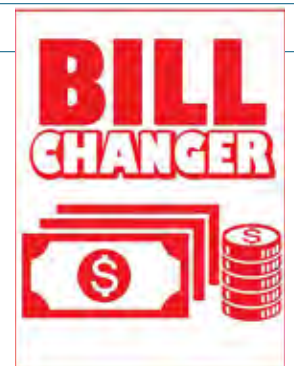

18" x 24" POLYSTYRENE BILL CHANGER SIGN
INSTRUCTIONAL SIGNS

\$11.99 SI0124

SIGNS • BANNERS • DECALS

INSTRUCTIONAL SIGNS AND ACCESSORIES

RED & WHITE PRICE SIGNS

• 11" x 11" Plastic signs with 3/4" rounded corners • 1/8" holes in each corner • UV protective coat • Red on white plastic

\$6.99



SI51010



SI51042



SI51043



SI51044



SI51045



SI51046



SI51047



SI51052



SI51053



SI51054



SI51055



SI51063



SI51064



SI51065



SI51066

New!

BLUE & WHITE TOWEL SIGNS

• 11" x 11" Plastic signs with 3/4" rounded corners
• 1/8" holes in each corner • UV protective coat

\$6.99



SI52005



SI52010



13" x 9" SIGN

\$11.50 SIKR13091



14" x 12" POLYSTYRENE

\$7.25 SI0122



NYLON TAPIT ANCHOR

• 1/4" x 1"
• Secures signage firmly in place

\$0.21 NB0225



NYLON RIVET

• 1/4" x 3/4"
• 25 rivets per pack

\$6.20 NB2575

SIGNS • BANNERS • DECALS

INSTRUCTIONAL SIGNS

RED & WHITE CAR WASH SIGNS

SIGNS

• 11" x 11" Plastic signs with 3/4" rounded corners • 1/8" holes in each corner • UV protective coat • Red on white plastic

\$6.99



SI51057



SI51058



SI51056



SI51023



SI51067



SI51068



SI51069



SI51070



SI51001



SI51003



SI51004



SI51005



SI51024



SI51025



SI51026



SI51028

SIGNS • BANNERS • DECALS

INSTRUCTIONAL SIGNS

RED & WHITE CAR WASH SIGNS

• 11" x 11" Plastic signs with 3/4" rounded corners • 1/8" holes in each corner • UV protective coat • Red on white plastic

\$6.99



SI51007



SI51008



SI51009



SI51030



SI51006



SI51012



SI51013



SI51014



SI51015



SI51016



SI51017



SI51018



SI51019



SI51020



SI51021



SI51011

SIGNS • BANNERS • DECALS

INSTRUCTIONAL SIGNS

16" x 9" POLYSTYRENE BI-LINGUAL DELUXE SIGNS

• Easily convey important messages to your customers in English and Spanish!

\$8.70



SIKRBL007

SIKRBL006

SIKRBL005

SIKRBL001

SIKRBL009

SIKRBL010

SIKRBL008

SIKRBL002



18" x 24" BI-LINGUAL INSTRUCTION SIGNS

• Lexan In-Bay Clean-Up Series

\$24.99

SI0111	Spot Free Rinse	SI0111P	Pre-soak
SI0111E	Engine & Degreaser	SI0111S	High Pressure Soap
SI0111FB	Brush Wash	SI0111W	Ultra Wax

24" x 18" PURPLE BI-LINGUAL SIGN

• Lexan Brush Wash instructional sign

\$24.99 SI0108

CRYPTOPAY INSTRUCTIONAL SIGNS & DECALS



CPS3017T



CPS3017D



CPS3017



CPS3015



CPS3015D



CPS3015T



CPS3016



CPS3016D

\$12.50	CPS3015	Count Up Sign - 10" x 12"
CALL	CPS3015C	Count Up Sign - 10" x 12" - Custom
\$12.50	CPS3015D	"Advanced" Count Down Sign - 10" x 12" For use with Dixmor Timers made after 2005
\$12.50	CPS3015T	Count Down Sign - 10" x 12" For Use with Dixmor Timers made before 2005 and all other count down timers
\$0.98	CPS3017	Count Up Decal - 4" x 5"
\$0.98	CPS3017D	Count Down Decal - 4" x 5" For use with Dixmor Timers made after 2005
\$0.98	CPS3017T	Count Down Decal - 4" x 5" For Use with Dixmor Timers made before 2005 and all other count down timers
\$12.50	CPS3016	10" x 12" - CryptoTap Plus Count Up Decal
\$12.50	CPS3016D	10" x 12" - CryptoTap Plus Count Down Decal

SIGNS • BANNERS • DECALS

INSTRUCTIONAL SIGNS



16" x 23" PICTORIAL SIGNS GINSAN SIGNS

• Durable 16" x 23" polylamine signs will eliminate any confusion on how to use a function or product with these visual instructions!

CALL FOR PRICING



PRE-SOAK GINSAN SIGNS

SIG21091



FOAMING BRUSH GINSAN SIGNS

SIG21065



DE-GREASER GINSAN SIGNS

SIG21064



TRI-FOAM BRUSH GINSAN SIGNS

SIG21069



CLEAR COAT GINSAN SIGNS

SIG21096



TRI-FOAM CONDITIONER GINSAN SIGNS

SIG21076



WHEEL & TIRE CLEANER GINSAN SIGNS

SIG21094



HIGH PRESSURE SOAP GINSAN SIGNS

SIG21074



BUG OFF GINSAN SIGNS

SIG21012



LIQUID WAX GINSAN SIGNS

SIG21090



SPOT FREE RINSE GINSAN SIGNS

SIG21067

POLYSTYRENE BUCKET WASHING/TOWEL DRYING AND INSTRUCTIONAL SIGNS

SIGNS



9" x 16" SIGN SIGNS

\$8.80 SI0105



9" x 16" SIGN SIGNS

\$8.80 SI0106



24" x 18" SIGN SIGNS

\$12.50 SI0110



24" x 18" SIGN SIGNS

\$12.75 SI0109

SIGNS • BANNERS • DECALS

INSTRUCTIONAL SIGNS



16" x 9" POLYSTYRENE SIGNS

\$12.33 SIKR047N



16" x 9" POLYSTYRENE SIGNS

\$8.80 SI0146



16" x 9" POLYSTYRENE SIGNS

\$8.80 SI0144



16" x 9" POLYSTYRENE SIGNS

\$10.75 SI0142



16" x 9" POLYSTYRENE SIGNS

\$8.80 SI0127

DON'T SEE EXACTLY WHAT YOU'RE LOOKING FOR?

Kleen-Rite offers custom sign creation! Call us today for a quote on custom signage for your car wash!



18" x 24" POLYSTYRENE SIGNS

\$11.15 SI0107



18" x 24" POLYSTYRENE SIGNS

\$27.76 SIKR048N



18" x 24" POLYSTYRENE SIGNS

\$27.76 SIKR050N



18" x 24" POLYSTYRENE SIGNS

\$27.76 SIKR051N



18" x 24" POLYSTYRENE SIGNS

\$27.76 SIKR036N



18" x 24" POLYSTYRENE SIGNS

\$27.76 SIKR200



18" x 24" POLYSTYRENE SIGNS

\$27.76 SIKR205

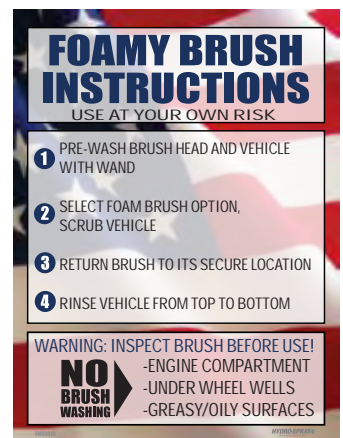

34" x 32" SIGN SIGNS

\$103.21 HSSN55010

SIGNS • BANNERS • DECALS

INSTRUCTIONAL SIGNS & DECALS

WASHING INSTRUCTIONS

WARNING HIGH PRESSURE - GRASP WAND FIRMLY IN HAND BEFORE INSERTING COINS

CAUTION FLOOR MAY BE SLIPPERY WHEN WET

WASH SOAP Turn selector knob to WASH/SOAP. Wash vehicle with High pressure soap from bottomup.

FOAM BRUSH Check brush for dentifines. Turn selector knob to FOAM BRUSH. Use brush gently, scrub entire vehicle. Return brush to holder.

SI0130 MENU SIGN SHOWN MENU STRIPS SOLD SEPARATELY!

Try Our Drying Towels!

Try Our Vacuums!

Have A Nice Shiny Day!

No bucket or handwashing when other customers are waiting.
THANK YOU FOR YOUR BUSINESS. PLEASE COME AGAIN!

CAR WASH MENU SIGNS

SIGNS

PRICE	PART #	DESCRIPTION
\$32.50	SI0130	8 Position Sign (23" x 35")
\$32.50	SIBL0130	8 Position Bilingual
\$41.50	SI0130-10	10 Position Sign (23" x 41.5")
\$41.50	SIBL0130-10	10 Position Bilingual
\$50.50	SI0130-12	12 Position (23" x 47")

California Proposition 65

3" H x 21½" L MENU STRIPS

SIGNS

- Colorful Lexan strips with glossy finish for your INSTRUCTION SIGNS!
- SIGNS SOLD SEPARATELY

ENGLISH	BILINGUAL	DESCRIPTION	COLOR
SI0130S1	SIBL21232	Wash/Soap	Orange
SI0130S2	SIBL21231	Rinse	Yellow
SI0130S3	SIBL21237	Wax	Green
SI0130S4	SIBL21233	Foam Brush	Blue
SI0130S5	SIBL21239	Stop	Red
SI0130S6	SIBL21235	Tire Cleaner	White
SI0130S7	SIBL21234	Engine Cleaner	Gold
SI0130S8	SIBL21240	Tire/Engine Cleaner	Brown
SI0130S9	SIBL21238	Spot Free Rinse	Teal
SI0130S10	SIBL21230	Presoak	Pink
SI0130S11	SIBL21242	Clear Coat	R/Y/B
SI0130S12	SIBL21241	Foamy Conditioner	R/Y/B
SI0130S13	SIBL21243	Tri Foam	R/Y/B
SI0130S14	SIBL21244	Air Dry	Gold
SI0130S17	SIBL21247	Self Serve Tire Shine	Orange
SI0130S18	SIBL21248	Under Carriage Clean	Blue
SI0130S19	-	De-Salt	Gray
SI0130S20	-	Bug off	Green
\$2.67	\$2.67		

3" H x 22" L DELUXE MENU STRIPS

SIGNS & DECALS

CMPST1	Presoak	CMPST11	Low Pressure Wax	CMPST21	Ceramic Sealer
CMPST2	Hi-Pressure Rinse	CMPST12	Clear Coat	CMPST22	Simoniz Hot Wax
CMPST3	HP Soap	CMPST13	Triple Foam Brush	\$4.73 EACH	
CMPST4	Foam Brush	CMPST14	Triple Foam Conditioner		
CMPST5	Engine/Degreaser	CMPST15	Bug Remover		
CMPST6	Tire Cleaner	CMPST16	Air Dry		
CMPST7	Tire/Engine	CMPST17	Self Serve Tire		
CMPST8	Wax	CMPST18	Undercarriage		
CMPST9	Spot Free Rinse	CMPST19	De Salt		
CMPST10	Stop	CMPST20	High Pressure Wax		

ALUMINUM EXTREME MENU SIGNS

SIGNS

\$53.85	CMBS1E	8 Position Yellow Sign, Blue Text	23" x 35"
	CMBS1F	8 Position Blue Sign, Yellow Text	
\$69.24	CMBS1QM	10 Position Yellow Sign, Blue Text	23" x 45"
	CMBS1RM	10 Position Blue Sign, Yellow Text	

CALIFORNIA PROPOSITION 65 NOTE: some items on this page may fall under the Proposition 65 act. Please consult the State of California Proposition 65 list (oehha.ca.gov/proposition-65/proposition-65-list) to learn more and to see a comprehensive list of Proposition 65 chemicals.

SIGNS • BANNERS • DECALS

INSTRUCTIONAL SIGNS & DECALS

ROTARY DECALS - OLD STYLE

THESE CIRCLES ARE ALSO AVAILABLE IN BILINGUAL

To order bilingual versions add "BL" to end of corresponding part number

\$0.64 EACH



ROTARY DECALS - NEW STYLE

CIRCLE DECALS

\$0.85 EACH



8 POSITION ROTARY DECAL WITH CIRCLES

- 3 1/2" x 3 1/2"
- Colorful circles are used to show functions
- Looks great with coordinating menu signs.

\$7.25 **CB0345**



10 POSITION ROTARY DECAL WITH CIRCLES

\$7.75 **CB0345-10**



8 POSITION ROTARY DECAL WITH CIRCLES

- 4" x 4"
- Circles stick on the back

\$9.13 **DERS8**



10 POSITION ROTARY DECAL WITH CIRCLES

- 4" x 4"
- Circles stick on the back

\$10.18 **DERS10**

SIGNS • BANNERS • DECALS

INSTRUCTIONAL SIGNS & DECALS

4" x 2½" SUPER VAC PRICE DECALS



VA30077



VA30305

PART #	DECAL TEXT
VA30076	\$.25 - Deposit 1 Quarter
VA30077	\$.50 - Quarters Only
VA30216	\$.75 - Quarters Only
VA30301	\$1.00 - Quarters Only
VA30302	\$1.25 - Quarters Only
VA30303	\$1.50 - Deposit 6 Quarters
VA30304	\$1.75 - Deposit 7 Quarters
VA30305	\$2.00 - Deposit 8 Quarters
VA30306	\$2.25 - Deposit 9 Quarters
VA30307	\$2.50 - Deposit 10 Quarters

\$1.15 EACH

1½" x 1½" BLUE & WHITE PRICE DECAL



DE15-9



DE15-2

PART #	DECAL TEXT
DE15-1	\$.25 - Insert 1 Quarter
DE15-2	\$.50 - Insert 2 Quarters
DE15-3	\$.75 - Insert 3 Quarters
DE15-4	\$1.00 - Insert 4 Quarters
DE15-5	\$1.25 - Insert 5 Quarters
DE15-6	\$1.50 - Insert 6 Quarters
DE15-7	\$1.75 - Insert 7 Quarters
DE15-8	\$2.00 - Insert 8 Quarters
DE15-9	\$2.25 - Insert 9 Quarters
DE15-10	\$2.50 - Insert 10 Quarters

\$0.55 EACH

1½" x 1½" TIME DECALS



DE15263



DE15270

PART #	DECAL TEXT
DE15262	2 Minutes
DE15263	2½ Minutes
DE15264	3 Minutes
DE15265	3½ Minutes
DE15266	4 Minutes
DE15267	4½ Minutes
DE15268	5 Minutes
DE15269	5½ Minutes
DE15270	6 Minutes

\$1.05 EACH



3½" x 3½" DECAL

\$0.87 CB0348



3½" x 2½" DECAL

\$1.25 DE030

3" x 4" SILVER & BLACK DECALS

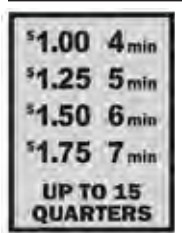

CB336-44

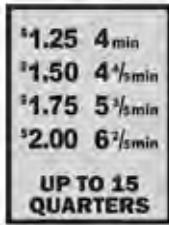

CB336-54

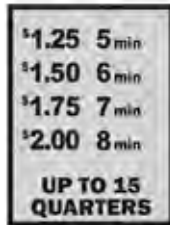

CB336-55

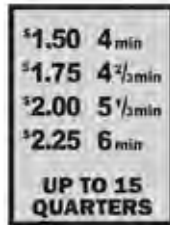

CB336-64

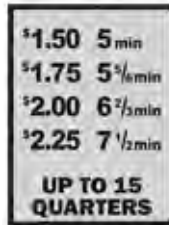

CB336-65

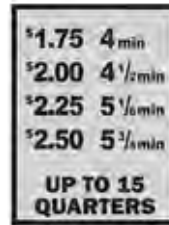

CB336-74

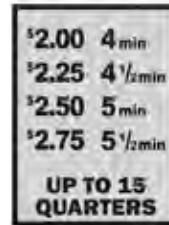

CB336-84

\$1.00 EACH

3" x 4" SILVER & BLACK DECALS



CB335-2



CB335-3



CB335-4



CB335-5



CB335-6



CB335-7



CB335-8

\$1.00 EACH



CB335-9



CB335-10



CB335-11



CB335-13



CB335-14



CB335-15



CB335-16

SIGNS • BANNERS • DECALS

DECALS

3" x 3" BLACK & YELLOW DECALS

\$0.92 EACH



CB0440-5



CB0440-10

PART #	DECAL TEXT
CB0440-2	Deposit \$.50
CB0440-3	Deposit \$.75
CB0440-4	Deposit \$1.00
CB0440-5	Deposit \$1.25
CB0440-6	Deposit \$1.50
CB0440-7	Deposit \$1.75
CB0440-8	Deposit \$2.00
CB0440-10	Deposit \$2.50
CB0440-12	Deposit \$3.00
CB0440-13	Deposit \$3.25
CB0440-14	Deposit \$3.50
CB0440-15	Deposit \$3.75
CB0440-16	Deposit \$4.00
CB0440-17	Deposit \$4.25
CB0440-18	Deposit \$4.50
CB0440-19	Deposit \$4.75
CB0440-20	Deposit \$5.00
CB0440-24	Deposit \$6.00

New!

3" x 3" BLACK & YELLOW DECALS

\$0.58 EACH



CB0347-5



CB0347-10

PART #	DECAL TEXT
CB0347-1	\$.25 - Deposit 1 Quarter
CB0347-2	\$.50 - Deposit 2 Quarters
CB0347-3	\$.75 - Deposit 3 Quarters
CB0347-4	\$1.00 - Deposit 4 Quarters
CB0347-5	\$1.25 - Deposit 5 Quarters
CB0347-6	\$1.50 - Deposit 6 Quarters
CB0347-7	\$1.75 - Deposit 7 Quarters
CB0347-8	\$2.00 - Deposit 8 Quarters
CB0347-9	\$2.25 - Deposit 9 Quarters
CB0347-10	\$2.50 - Deposit 10 Quarters
CB0347-11	\$2.75 - Deposit 11 Quarters
CB0347-12	\$3.00 - Deposit 12 Quarters
CB0347-13	\$3.25 - Deposit 13 Quarters
CB0347-14	\$3.50 - Deposit 14 Quarters
CB0347-15	\$3.75 - Deposit 15 Quarters
CB0347-16	\$4.00 - Deposit 16 Quarters
CB0347-17	\$4.25 - Deposit 17 Quarters
CB0347-18	\$4.75 - Deposit 18 Quarters
CB0347-19	\$4.50 - Deposit 19 Quarters
CB0347-20	\$5.00 - Deposit 20 Quarters

3" x 3" BLACK & YELLOW INSTRUCTIONAL DECALS

DECALS

\$0.92 EACH

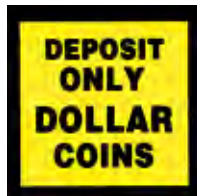

CBDD



CBDQD



CBDDT



CBDQDT



CBDQ

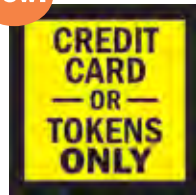

CBDT

New!

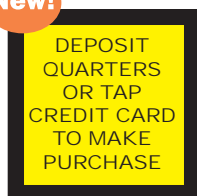

CBDQT

2 3/4" x 3" BLACK & WHITE DECALS

DECALS

\$0.93 EACH



DE347-2BK



DE347-5BK

PART #	DECAL TEXT
DE347-2BK	\$.50 - Deposit 2 Quarters
DE347-3BK	\$.75 - Deposit 3 Quarters
DE347-4BK	\$1.00 - Deposit 4 Quarters
DE347-5BK	\$1.25 - Deposit 5 Quarters
DE347-6BK	\$1.50 - Deposit 6 Quarters
DE347-7BK	\$1.75 - Deposit 7 Quarters
DE347-8BK	\$2.00 - Deposit 8 Quarters
DE347-9BK	\$2.25 - Deposit 9 Quarters
DE347-10BK	\$2.50 - Deposit 10 Quarters
DE347-11BK	\$2.75 - Deposit 11 Quarters
DE347-12BK	\$3.00 - Deposit 12 Quarters
DE347-13BK	\$3.25 - Deposit 13 Quarters
DE347-14BK	\$3.50 - Deposit 14 Quarters
DE347-15BK	\$3.75 - Deposit 15 Quarters
DE347-16BK	\$4.00 - Deposit 16 Quarters
DE347-17BK	\$4.25 - Deposit 17 Quarters
DE347-18BK	\$4.75 - Deposit 18 Quarters
DE347-19BK	\$4.50 - Deposit 19 Quarters
DE347-20BK	\$5.00 - Deposit 20 Quarters



New!

SIGNS • BANNERS • DECALS

SIGNS & DECALS



12" x 12" POLYSTYRENE SIGN
SIGNS

\$6.99 **SI0117**



12" x 12" POLYSTYRENE SIGN
SIGNS

\$6.99 **SI0135**



SIGN OR DECAL
SIGNS

\$6.99	SI0136	12" x 12" Polystyrene Sign
\$0.92	DE040	3" x 3" Decal
\$0.92	DE040S	3" x 3" Decal - Spanish



8" x 9" RED & WHITE POLYSTYRENE
PRICE SIGNS
DECALS

SI0102	\$.50 to Start Use 2 Quarters
SI0104	\$1.00 to Start Use 4 Quarters
SI0115	\$1.25 to Start Use 5 Quarters
SI0118	\$1.50 to Start Use 6 Quarters
SI0112	\$2.00 to Start Use 8 Quarters
SI0116	\$2.50 to Start Use 10 Quarters
\$6.06	

2³/₄" x 2³/₄" LEXAN PRICE DECALS
DECALS

\$1.07 EACH



	RED	SIGN	BLUE
DE275-1R	.25¢ Deposit 1 Quarter		DE275-1B
DE275-2R	.50¢ Deposit 2 Quarters		DE275-2B
DE275-3R	.75¢ Deposit 3 Quarters		DE275-3B
DE275-4R	\$1.00 Deposit 4 Quarters		DE275-4B
DE275-5R	\$1.25 Deposit 5 Quarters		DE275-5B
DE275-6R	\$1.50 Deposit 6 Quarters		DE275-6B
DE275-7R	\$1.75 Deposit 7 Quarters		DE275-7B
DE275-8R	\$2.00 Deposit 8 Quarters		DE275-8B
DE275-9R	\$2.25 Deposit 9 Quarters		DE275-9B
DE275-10R	\$2.50 Deposit 10 Quarters		DE275-10B
DE275-11R	\$2.75 Deposit 11 Quarters		DE275-11B
DE275-12R	\$3.00 Deposit 12 Quarters		DE275-12B
DE275-13R	\$3.25 Deposit 13 Quarters		DE275-13B
DE275-14R	\$3.50 Deposit 14 Quarters		DE275-14B
DE275-15R	\$3.75 Deposit 15 Quarters		DE275-15B
DE275-16R	\$4.00 Deposit 16 Quarters		DE275-16B
DE275-17R	\$4.25 Deposit 17 Quarters		DE275-17B
DE275-18R	\$4.50 Deposit 18 Quarters		DE275-18B
DE275-19R	\$4.75 Deposit 19 Quarters		DE275-19B
DE275-20R	\$5.00 Deposit 20 Quarters		DE275-20B



2" x 2" DECAL
DECALS

\$0.70 **DE010-2**



3" x 3" DECAL
DECALS

\$0.70 **DE010**



3" x 3" DECAL
DECALS

\$0.70 **DE015**



4" x 15" ARROW DECAL
DECALS

\$2.99 **SI0119**



4" x 3" HANG HOSE DECAL
DECALS

\$0.78 **CB0373**



3" x 4" DECAL
DECALS

\$0.92 **CBDTQ**



4" x 2" WARNING ALARM SYSTEM DECAL
DECALS

\$0.64 **CB0350**

SIGNS • BANNERS • DECALS

KLEEN-PET™ SIGNS & DECALS

FOR 7 MINUTES
FOR 8 MINUTES
FOR 9 MINUTES
FOR 13 MINUTES
FOR 15 MINUTES

FOR 10 MINUTES
FOR 11 MINUTES
FOR 12 MINUTES
FOR 14 MINUTES

\$6.00

\$7.00

\$8.00

\$9.00

\$10.00

\$11.00

\$12.00



TIME/PRICE DECAL SET
KLEEN-PET

\$7.75 PTW183

18" x 24" POLYSTYRENE SIGN
KLEEN-PET

\$27.76 PTW132

23" x 35" DOG WASH INSTRUCTIONAL SIGN
KLEEN-PET

\$41.50 PTW340

Check out the **SELF SERVE EQUIPMENT** section for our entire Pet Wash setup!

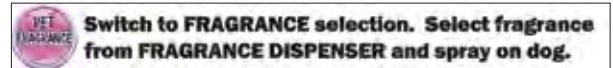

OPTIONAL FRAGRANCE STRIP
KLEEN-PET

\$4.73 PTW340-S



47¾" x 33" DOG WASH WINDOW & BUILDING SIGN (2 PIECES)
KLEEN-PET

\$361.00 PTW133L Left side of building
\$361.00 PTW133R Right side of building



22" x 16" DOOR DECAL
KLEEN-PET

\$48.99 PTW125

SELF SERVE EQUIPMENT



BOOMS AND CLEANERS

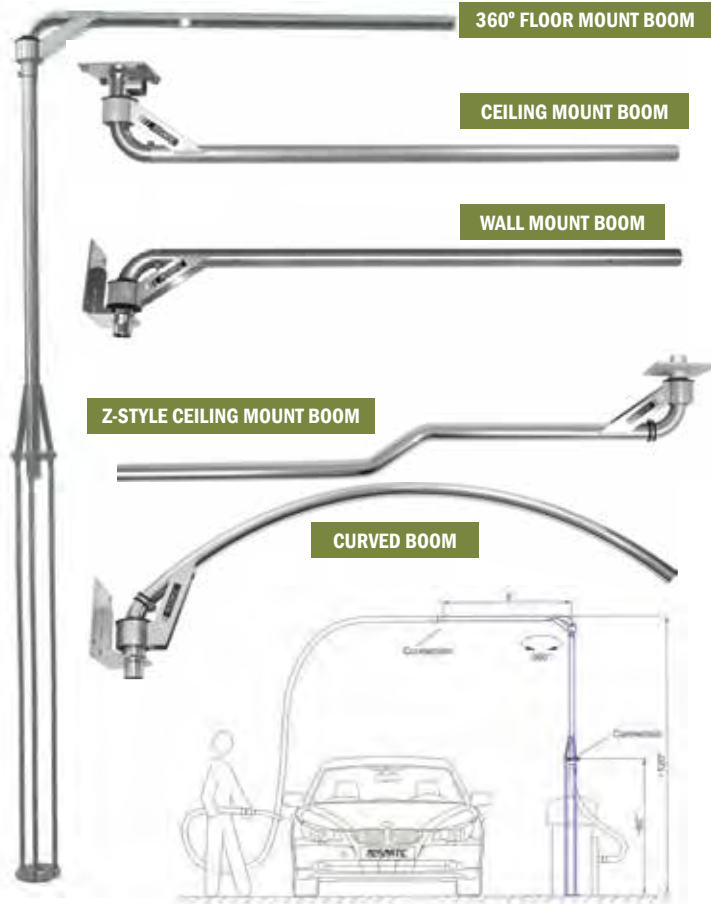

360° FLOOR MOUNT BOOM

CEILING MOUNT BOOM

WALL MOUNT BOOM

Z-STYLE CEILING MOUNT BOOM

CURVED BOOM

AIR SYSTEM BOOM

MOSMATIC

- Designed for use with either vacuum or drying systems. Eliminates the hose being dragged or left lying on the ground.
- **BOOM AVAILABLE IN 4 VERSIONS: CEILING, FLOOR, CURVED OR WALL MOUNT.**

CALL FOR PRICES	BOM60312	360° Floor Mount Boom
	BOM60958	Curved Boom
	BOM60310	Ceiling Mount Boom
	BOM60311	Wall Mount Boom
	BOM60326	Z-Style Ceiling Mount Boom

TENSION PULLEY

ELBOW



3' EXTENSION

BRACKET WITH BUMPERS



OPTIONS

MOSMATIC

CALL FOR PRICES	SWM60320	Tension Pulley
	BOMP60314	Elbow
	BOMP60315	3' Extension
	BOMP60319	Bracket With Bumpers



UCM80613

UCM80614

HIGH BODY UNDERCARRIAGE CLEANER

MOSMATIC

- The Mosmatic Undercarriage Cleaner makes it easy to clean the underside of vehicles. It can be used to clean cars, trucks and more. Agricultural and construction machinery can be cleaned on site without the use of a car lift. The Undercarriage Cleaner is time saving and cost effective. Can be used with hot or cold water. Rated for up to 4000 PSI, 250°F.

STABILIZER:

- When a stabilizer nozzle is installed on the Mosmatic Undercarriage Cleaner it has even more power. It will also increase the units reach. The version with the stabilizer nozzle also has a higher protective ring.
- The TUW is used with cold or hot pressure pumps
- Possible throughput medium pH 3 - 12
- 9" Clearance
- 3/8" NPTF
- Stainless steel wheels

CALL	UCM80613	2 Arms - 21"
	UCM80614	3 Arms - 30"

HURRICANE PRO ADJUSTABLE UNDERCARRIAGE CLEANER

MOSMATIC

- With the Hurricane Pro model you are not only able to clean underneath vehicles, you also have the ability to pivot the spray deck which allows for multiple cleaning angles. Deck adjustment from 0° to maximum 90°.
- The adjustable angles allow for "all-around" cleaning on constructions machines, fleet vehicles, boats or agricultural machines using just one model undercarriage cleaner.
- Three large swivel casters make your cleaning job easier with full range of motion, allowing you to maneuver even on rough surfaces. Standard long range stabilizer nozzles on the Mosmatic Hurricane Pro increases the distance and impact of your cleaning project. Use this cleaning tool from Mosmatic with either hot or cold high-pressure pumps.
- 6" Swivel castor
- Pressure up to 4000 PSI
- Temperature up to 250°F
- Adjustable spray deck
- Complete stainless steel (INOX)

CALL	UCM80617
-------------	-----------------



SELF SERVE EQUIPMENT

UNDERBODY CLEANING SYSTEMS



SELF SERVE UNDERBODY CLEANING SYSTEM HYDRO SPRAY WASH SYSTEMS, INC.

- **SIMPLE SYSTEM DESIGNED TO OFFER ADDITIONAL SERVICE**

WHAT IS THE SELF-SERVE UNDERBODY SYSTEM?

- The Self-Serve Underbody System gives vehicle owners the option to clean the undercarriage of their vehicle—a highly valued option during winter months when road salt can cause costly, corrosive damage to many vehicles.
- The underbody tool has a simple design allowing for safe and easy operation. With the turn of a dial and the squeeze of a trigger, three nozzles release a high-pressure spray that will remove salt, dirt, grime and debris.
- This system is a value adding service that installs directly into any existing serve-serve bay. Creating an entirely new cleaning option, this system increases the amount of time customers spend in the bay, produces additional revenue and increases customer loyalty. This cleaning option appeals highly to car wash operators in colder climates where vehicle owners are at an increased risk for corrosive damage as a result of road salt.

HOW DOES THE SYSTEM WORK?

- Utilizing one high-pressure stream—coming from any existing self-serve equipment—this system powers two high pressure cleaning tools. By installing this system's unique control valve panel operators maintain the existing high pressure flow to their self-serve bay while also creating a second high pressure option that, powers the underbody cleaning tool.
- Activating the underbody cleaning tool can be achieved by adding an underbody option to any existing meter box. If this is not the case, adding a push button activation may be required to activate the underbody system.
- Within the bay, a wall-mounted boom, hose, wall bracket and weep bucket are installed to house the underbody cleaning tool. To prevent this exposed fluid line from freezing, a check valve assembly is used to connect any existing water weep system to the underbody system. The weep bucket is then needed to catch and drain any resulting weep water.

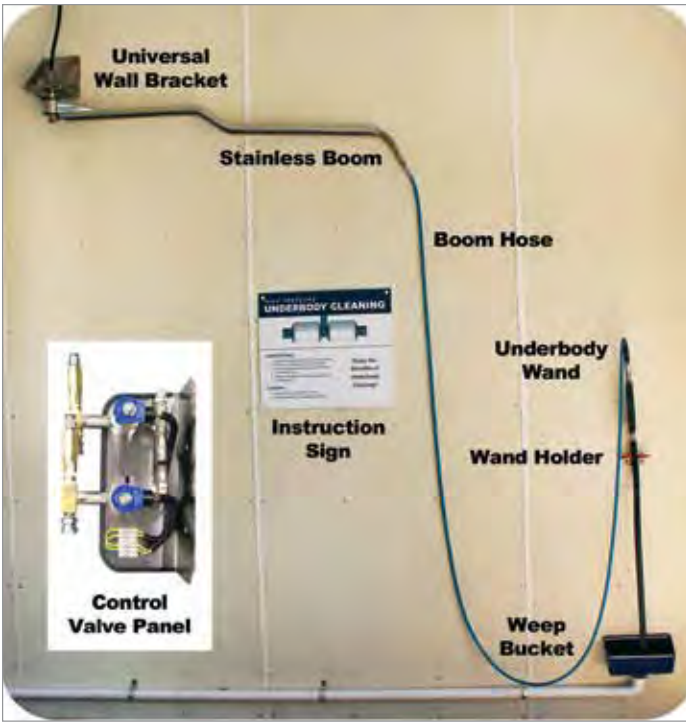

\$2,972.65	HSSA30*	Self Serve Underbody System (With Boom)	Red or Blue
\$1,988.82	HSSA300-NB*	Self Serve Underbody System (Without Boom)	Blue
\$1,988.82	HSSA300-NBR*	Self Serve Underbody System (Without Boom)	Red

* Drop Shipped Items

WAND ASSEMBLIES & PARTS HYDRO SPRAY WASH SYSTEMS, INC.

\$363.39	HSAP32B-NW	Self Serve Underbody Wand Assembly - Non-Weep	Red or Blue
\$363.39	HSAP32B-W	Self Serve Underbody Wand Assembly - Weep	Red or Blue
\$35.65	HSBA92105B	Blue Bent Handle for Underbody System	Blue
\$35.65	HSBA92105R	Red Bent Handle for Underbody System	Red

SELF SERVE EQUIPMENT

TIRE SHINE & COMBO MACHINES



Customers are happy to pay for a service that turns tedious tire cleaning and tire dressing application into a convenient machine-based process. Quality tire shine makes vehicles look brand new!



TIRE SHINE DETAIL STATION

J.E. ADAMS



STANDARD FEATURES:

- Louvered sides prevent heat build-up inside cabinet
- Imonex mechanical quarter coin acceptor comes standard, additional mechanical coin acceptors are available
- Large digital display timer – scrolls messages, counts down time, scrolls price of services
- Medeco threaded door locks
- Pin lock style coin box
- Thomas 1/12HP oil-less compressor
- Internal automatic heater
- Wall or pedestal mounted
- Comes with one gallon of JE Adams pre-mixed Tire Shine formula

CALL	VAA16000	Tire Shiner
	VAA16000VR	Tire Shiner, Vault Ready
	VAA16000V	Tire Shiner, Bill Validator
	VEA8819	Pedestal

SHOWN WITH OPTIONAL BLUE DECAL

TIRE SHINE & AIR COMBO CONVERSION KIT

VACUUM CONVERSION KITS

- Convert your "little-used vacuum" to make more money
- Use existing vacuum timer
- 110 VAC power
- Installation approximately one (1) hour

KIT CONTAINS:

- Thomas compressor and pumping system
- Decals
- Air hose and gauge
- Tire shine hose/gun
- Cover for vacuum outlet
- Hose brackets

CALL **TS6000C**

TIRE SHINE CONVERSION KIT

VACUUM CONVERSION KITS

LOOKING FOR A NEW PROFIT CENTER? LIMITED FUNDS? \$2.00/VEND

KIT CONTAINS:

- Utilizes your current vacuum timer – merely connect power to terminals indicated
- Spray gun with applicator (two applicators included – Brush and Sponge)
- Container to hold product vacuum outlet cover
- Pumping system
- Hose
- 110 Volt AC Power
- 20 Ft of hose and bracket
- Two decals for your vacuum

\$1,107.99 **TS4000**

TIRE SHINE SPONGE HEAD APPLICATOR

REPLACEMENT PART

A replacement sponge head for TS19006 tire shine applicator gun. Tire shine sponge applicator with 1/4" NPT connection

SPECIFICATIONS:

- 1/4" NPT Connection
- Applicator only
- OEM replacement part

\$21.57 **TS19005**



TIRE SHINING DETAILING GUN

REPLACEMENT PART

This detailing gun boasts a brush with a spray nozzle in the center and a check valve

- Genuine Crown Equipment accessory
- Gun has Viton seals
- Spray nozzle in the center of the brush

\$89.33 **TS19007**



SELF SERVE EQUIPMENT



AIR SHAMMEE DRYERS

AIR SHAMMEE DISKIN SYSTEMS

- Handheld self serve car dryer can be universally attached to any vacuum or car wash bay. Three tangential discharge motors. Air speed of over 320 miles per hour. Lighted dome available in any standard color. Cost-effective alternative to adding expensive in bay dryers. Place outside of your dryer-less conveyor wash. Can be adapted to any car wash bay or vacuum.



BOOM NOT INCLUDED

AIR SHAMMEE DISKIN SYSTEMS

- INCLUDES:**
- 3 motor blower unit
 - Trigger nozzle
 - Shroud: for wall-mount only
 - Selector Switch Decal
 - Hose (Specify color)
 - Hose Hanger
 - In-Bay Sign

WALL MOUNTED				
\$1,374.25	ASHWALL-BL-110	Blue dome / hose	●	110V
\$1,374.25	ASHWALL-BL-220	Blue dome / hose	●	220V
\$1,374.25	ASHWALL-Y-110	Yellow dome / hose	●	110V
\$1,374.25	ASHWALL-Y-220	Yellow dome / hose	●	220V
\$1,374.25	ASHWALL-R-110	Red dome / hose	●	110V
\$1,374.25	ASHWALL-R-220	Red dome / hose	●	220V

ATTIC MOUNTED				
\$1,373.75	ASHATTIC-BL-110	Blue / hose	●	110V
\$1,373.75	ASHATTIC-BL-220	Blue / hose	●	220V
\$1,373.75	ASHATTIC-Y-110	Yellow / hose	●	110V
\$1,373.75	ASHATTIC-Y-220	Yellow / hose	●	220V
\$1,373.75	ASHATTIC-R-110	Red / hose	●	110V
\$1,373.75	ASHATTIC-R-220	Red / hose	●	220V



**BOOM NOT INCLUDED
REQUIRES 3 PHASE**

SUPER AIR SHAMMEE II DISKIN SYSTEMS

- INCLUDES:**
- 3-phase single motor
 - Trigger nozzle
 - Selector Switch Decal
 - Hose (Specify color)
 - Hose Hanger
 - In-Bay Sign
 - Contacter Component
- FEATURES:**
- 10% more powerful
 - Very quiet
 - Longer life
 - Maintenance free
 - Water sealed bearings
 - Brushless Motor
 - On/off trigger nozzle

WALL MOUNTED				
\$1,760.00	ASHWALL-S-BL	Blue dome / hose	●	
\$1,760.00	ASHWALL-S-Y	Yellow dome / hose	●	
\$1,760.00	ASHWALL-S-R	Red dome / hose	●	

ATTIC MOUNTED				
\$1,772.31	ASHATTIC-S-BL	Blue / hose	●	
\$1,772.31	ASHATTIC-S-Y	Yellow / hose	●	
\$1,772.31	ASHATTIC-S-R	Red / hose	●	

WHEN ORDERING YOUR AIR SHAMMEE...

PLEASE SPECIFY:

DOMES COLOR
Yellow, Blue or Red

HOSE COLOR
Blue, Red, Yellow,
Green & Black

VOLTAGE
(110V, 220V or 3 Phase)

SELF SERVE EQUIPMENT

AIR SHAMMEE & AIR SHAMMEE II REPLACEMENT PARTS



DBOOM SHOWN

BOOMS DISKIN SYSTEMS



\$420.00	DBOOM	Boom
CALL	BOM60310	Ceiling Mount
	BOM60311	Wall Mount
	BOM60312	Floor Mount



4.6 HP SUPER AIR SHAMMEE II DISKIN SYSTEMS



- Uses: Upgrade existing Air Shammees already in the field or as a replacement for failed motors.
- Super motor - blower only

\$1,472.97	ASHMTR
-------------------	---------------



AIR SHAMMEE MOTORS DISKIN SYSTEMS



\$63.85	VMK4MP	120V Motor
\$65.00	VMK5MP	220V Motor
\$6.90	VMKB1015	Brush Kit - 220V Motor
\$5.96	VMKBRUSH	Blower Brush - 120V Motor



NOZZLE DISKIN SYSTEMS



\$93.75	ASHNOZ
----------------	---------------



NOZZLE HOLDER DISKIN SYSTEMS



\$43.65	ASHHOOK
----------------	----------------



AIR SHAMMEE I DOME DISKIN SYSTEMS



- 20" diameter x 10" high

\$74.95	ASHDOME-BL	Blue
\$74.95	ASHDOME-R	Red
\$74.95	ASHDOME-Y	Yellow



AIR SHAMMEE II DOME DISKIN SYSTEMS



- For Air Shammee II vacu units

\$169.51	ASH2110B	Blue
\$169.51	ASH2110R	Red
\$169.51	ASH2110Y	Yellow



FAN TIP FOR NOZZLE DISKIN SYSTEMS



\$42.00	ASHFAN
----------------	---------------



AIR SHAMMEE II SIGN KLEEN-RITE

- 12" x 18"

\$26.50	BAYSN2
----------------	---------------



AIR SHAMMEE SIGN KLEEN-RITE

- 12" x 18"

\$26.50	BAYSN
----------------	--------------



AIR SHAMMEE BANNER KLEEN-RITE

- 3' x 8'

\$113.21	BANNER3806
-----------------	-------------------

SELF SERVE EQUIPMENT

DRYERS



TURBO TOWEL AIR DRYER

J.E. ADAMS



- Great for drying motorcycles, chrome wheels, and engine compartments
- Internal heating element heats the air at 120°F above ambient temperature to provide a streak and spot free finish
- Turbo Towel is eco-friendly too! Minimize landfill waste from purchased and non-recyclable products
- Uses (1) 120 volt high-performance blower motor
- Use Turbo Towel to quickly dry off the exterior of your car
- Dry floor mats and carpets in a matter of minutes
- Thermostatically controlled heating element
- Eliminates storage and transportation of wet towels
- First blower on the market with heated air
- Blast water out of cracks and crevices
- Requires 30 AMP service
- Nozzle velocity exceeds 200+ MPH
- Includes a 2" x 30" high temperature hose

\$3,101.19

VAA17000

WITHOUT Bill Acceptor

\$3,803.57

VAA17000V

WITH Bill Acceptor



TURBO TOWEL DRYER

J.E. ADAMS



- Quickly dries off vehicle exteriors with a streak and spot free finish, blast water out of cracks and crevices, dry floor mats and carpets in a matter of minutes!
- New design allows for motor brushes to be easily accessed and changed

FEATURES/SPECIFICATIONS:

- Requires 30 AMP service
- Ties directly to meter box
- (1) 120 volt high-performance blower motor
- Eliminates storage and transportation of wet towels
- Thermostatically controlled heating element will engage when ambient temperature is below 79°F
- Mounts on wall or in attic of in-bay self serve car wash
- Dimensions 10" W x 10" D x 19.5" L
- Nozzle velocity exceeds 200+ MPH
- 2" x 30' high temperature hose with nozzle included
- Wall signage and meter decal included

\$1,071.43

VAA18000

120V

\$1,113.10

VAA18000-220

220V

ACCESSORIES & REPLACEMENT PARTS FOR TURBO TOWEL DRYERS

DRYER ACCESSORIES



VAA2936-2

\$464.29

VAA6063

Boom

8" W x 20" x 68" L Boom on a 6" W x 8" H Mounting Plate

\$95.71

VAA2036-2

Black High Heat Hose

2" x 30'

\$95.71

VAA2036-2BL

Blue High Heat Hose

2" x 30'

\$95.71

VAA2036-2R

Red High Heat Hose

2" x 30'



BLUE OR RED COVERS AVAILABLE

PRICE INCLUDES WALL MOUNT BOOM

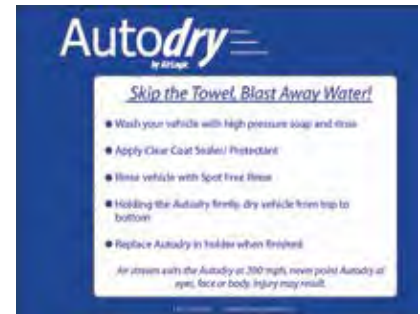

\$114.80

AD2000

Non-swivel

\$114.80

AD2000-S

Swivel

RUBBERIZED "LINE X" COATED FOR EXTRA DURABILITY

AUTODRY IN BAY HANDHELD DRYER SYSTEM AIR LOGIC

- Provides a great drying tool to customers and an extra revenue source for your business! An excellent option to skip the towels while still removing excess water!
- 3 motor in-line design maximizes air flow and drying power
- Durable one-piece molded gun
- Systems include boom and in-bay instruction sign
- 220V power required

CALL

AD0220-R

Red

AD0220-BL

Blue

SELF SERVE EQUIPMENT



SIMONIZ® HOT WAX & SHINE SELF-SERVE PACKAGES

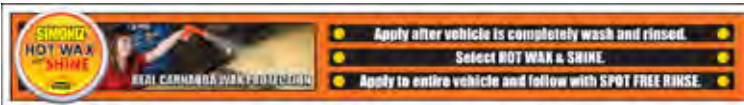

3" H X 22" L DELUXE MENU STRIP SIGNS

\$4.73 EACH **CMPST22**

HOT WAX & SHINE SIMONIZ

- Gone are the days of painstaking waxing by hand! Give your busy customers a waxed and shiny car in no time at all by incorporating Simoniz Hot Wax and Shine into your self-serve car wash bays. Hot Wax and Shine has a special formula that uses real carnauba wax, liquified and distributed across a clean car. When buffed or rinsed away, it leaves the vehicle ultra-shiny and protected!
- In self-serve bays, it is easily applied by hand through a dedicated foam hose and gun
- Simoniz® Hot Wax and Shine is a major profit driver at car washes across the country. By offering this specialized product, operators are able to increase the price of their top wash packages - or even create a new top package at a premium!
- Use 2 - 4 oz per car.

\$160.63	PA5338	5 Gal.
\$1,004.90	DR30338	30 Gal.



SELF SERVE EQUIPMENT

ALL PAWS DOG/PET WASH STATION

COMPLETE PET WASH - STAINLESS STEEL

ALL PAWS PET WASHES

- The All Paws Pet Wash Equipment Package is a complete unit that provides a convenient spot to clean dogs and other pets! The cabinet and tub are made with high-quality materials and feature eye-catching graphics. Accepts bills and coins for operation.

INFORMATION:

- Eye-Catching design with light blue paws and yellow "DOG WASH" logo
- Allows customers a convenient place to wash their pets - extra revenue stream for your car wash
- Pitched tub provides gravity draining
- Stainless Steel Model Weight: 950 lbs.
- Powder Coated Model Weight: 850 lbs.
- Wall-less Model Weight: 400 lbs.

PACKAGE INCLUDES:

- Large tub with end step
- Equipment cabinet (with plumbing)
- Coin & bill acceptor
- Dixmor timer
- ADA compliant push button system - 9 button interface
- Fur dryer for wash Tub
- Informational signage
- GFI electrical outlets
- Hair straining system
- Chemical startup kit - 1 Gallon of each treatment (6 products)
- Box of 100 treats



PTW2000-AS

STAINLESS STEEL



PTW2000-AA

POWDER COATED ALUMINUM

COMPLETE PET WASH PACKAGES

COMPLETE PET WASH (CABINET AND TUB) - STAINLESS STEEL	
\$22,291.76	PTW2000-AS
Dimensions: Width: 81" / 95" with step Height: 70" Tub Depth: 27	
COMPLETE PET WASH (CABINET AND TUB) - POWDER COATED ALUMINUM (BLUE)	
\$17,882.35	PTW2000-AA
Dimensions: Width: 81" / 95" with step Height: 70" Tub Depth: 27	

OPTIONAL ADD-ONS

\$660.00	PTW2000-A1	CryptoPay Swiper ONLY
\$860.00	PTW2000-A2	CryptoPay Swiper & Coordinator
\$840.00	PTW2000-A3	Instant Hot Water Heater

RECOMMENDED PLACES FOR PET WASH STATIONS:

Car Wash | Campground/RV Park | Convenience Store | Gas Station | Pet Store | Dog Park | Kennel | Pet-Friendly Hotel Apartment Building | Veterinarian Office | Beach

PET WASH CHEMICAL START-UP PACKAGE & TREATS

When you purchase an All Paws Pet Wash you receive one gallon of each of the below chemicals!



TUB CLEANER
KLEEN-PET CHEMICALS

PTW230



TEARLESS SHAMPOO
KLEEN-PET CHEMICALS

PTW215



DE-SKUNK
KLEEN-PET CHEMICALS

PTW232



OATMEAL TREATMENT SHAMPOO
KLEEN-PET CHEMICALS

PTW201



VETERINARY GRADE SHAMPOO
KLEEN-PET CHEMICALS

PTW231



CONDITIONER
KLEEN-PET CHEMICALS

PTW202

FLAVORED DOG TREATS

PET WASH SUPPLIES & PARTS

- 1 oz. package - 100 packages per case
- PEANUT BUTTER TREATS:** barley flour, palm oil, honey, rolled oats, peanut butter, oat flour, coconut oil, flax, peanut flour
- PUMPKIN TREATS:** barley flour, palm oil, honey, rolled oats, pumpkin, oat flour, flax, coconut oil, chia seeds, cinnamon, ginger, allspice, cloves
- CHEESE & BACON TREATS:** barley flour, palm oil, honey, rolled oats, cheddar cheese, flax, coconut oil, natural bacon flavor

\$84.38	PTW175-PB	Peanut Butter & Honey Treats
FREE	PTW175-PB-O	Peanut Butter & Honey Treats Vending Overlay
\$84.38	PTW175-CB	Cheese & Bacon Treats
FREE	PTW175-CB-O	Cheese & Bacon Treats Vending Overlay



Your All Paws Pet Wash comes with a case of 100 delicious dog treats. Need to order more? We've got you covered!

SELF SERVE EQUIPMENT

KLEEN-PET™ DOG/PET WASH STATION



**COMPLETE PET WASH UNIT
PTW1000**

DIMENSIONS & WEIGHT
Length (with ramp extended) 92.5"
Width: 35"
Height (top of supply cabinet): 51.5"
Weight (packed/shipping): 300 lbs
Non-Slip Ramp: PTW168



WAIST HIGH TUB



SOOTHING DRYER OPTION



PLEASANT WASHING EXPERIENCE FOR PET & OWNER



DOG WASH WINDOW DECAL
22" x 16"



TURN THAT UNUSED BAY INTO A PROFIT MAKING MACHINE WITH THE KLEEN-PET™ SELF-SERVE PET WASH!!

KLEEN-PET™ SELF SERVE PET WASH KLEEN-PET

- The Kleen-Pet™ Self Serve Pet Wash is equipped with a stainless steel coin meter and rotary switch. The coin meter accepts tokens or coins. The rotary switch allows the pet owner to select a variety of grooming activities such as shampoo, rinse, condition and a flea and tick treatment. A soothing dryer option is also provided. The easy non-slip ramp invites the pet into the tub. The waist high tub provides the owner with comfortable access to their pet.

COMPLETE PACKAGE INCLUDES:

- Chemical start-up package
- Deluxe decal and graphics package
- 3/4" Honeywell blending valve
- Shower head w/easy pull trigger and S/S flexible hose
- S/S tub ring w/attached leash restraint
- S/S tub w/rubber mat & S/S rubber coated ramp
- S/S control panel
- Deluxe S/S coin box w/bill acceptor w/10-position rotary switch
- Optional credit card acceptance system
- 2 motor, dual speed dryer

STANDARD FEATURES:

- Non-slip rubber mats for pet safety
- Stainless steel frame & body
- Easy access entry
- Safety Tie Down
- Coin Operated

DON'T SETTLE FOR JUST A TUB! GET THE COMPLETE DOG WASH PACKAGE!

CALL PTW1000



DELUXE COIN BOX DECAL PACKAGE

KLEEN-PET

- Full face dog wash decal features cutouts for:
 - Bill acceptor
 - Readout timer
 - Optional credit card acceptor
 - 10-position rotary switch
- Rotary positions included on decal:
 - Oatmeal
 - Veterinary Shampoo
 - Pet Shampoo
 - Rinse
 - Tub Cleaner
 - Pet Vacuum
 - Gentle Dry
 - Conditioner
 - Stop
 - Pet Fragrance
 - Tub Cleaner
 - De-Skunk
 - Super Dry

\$39.99 PTW180

SELF SERVE EQUIPMENT

DOG/PET WASH SIGNS & DECALS

\$6.00	\$9.00	FOR 7 MINUTES
\$7.00	\$10.00	FOR 8 MINUTES
\$8.00	\$11.00	FOR 9 MINUTES
		FOR 10 MINUTES
		FOR 11 MINUTES
		FOR 12 MINUTES
		FOR 13 MINUTES
		FOR 14 MINUTES
		FOR 15 MINUTES
	\$12.00	

TIME/PRICE DECAL SET
KLEEN-PET

\$7.75 PTW183



COIN BOX DECAL
KLEEN-PET

- 10 Position
- Price, Time and Rotary Function Overlays included
- 8 and 12 Position Decals Also Available

\$39.99 PTW180



"TRY OUR NEW DOG WASH" SIGN
KLEEN-PET

- 18" x 24" Polystyrene Sign

\$27.76 PTW132



DOG WASH WASHING INSTRUCTIONS SIGN
KLEEN-PET

- Guide your customers with this basic washing instruction sign
- 23" x 35"

\$41.50 PTW340

OPTIONAL FRAGRANCE STRIP
KLEEN-PET

\$4.73 PTW340-S



47 3/4" X 33" DOG WASH WINDOW & BUILDING SIGN (2 PIECES)
KLEEN-PET

\$361.00 PTW133L Left side of building
\$361.00 PTW133R Right side of building

DOG WASH DECAL
KLEEN-PET

\$48.99 PTW125 22" x 16" Door Decal



12' NYLON FEATHER FLAGS
FLAGS

- MESSAGE READS ON ONE SIDE

\$39.99 PTW330 Flag
\$69.99 CWF1702 X-Stand
\$49.99 CWF50212 4 Piece Ground Spike Pole Kit

DOG/PET WASH CHEMICAL START-UP PACKAGE



TUB CLEANER
KLEEN-PET CHEMICALS

PTW230



TEARLESS SHAMPOO
KLEEN-PET CHEMICALS

PTW215



DE-SKUNK
KLEEN-PET CHEMICALS

PTW232



OATMEAL TREATMENT SHAMPOO
KLEEN-PET CHEMICALS

PTW201



VETERINARY GRADE SHAMPOO
KLEEN-PET CHEMICALS

PTW231



CONDITIONER
KLEEN-PET CHEMICALS

PTW202



SELF SERVE EQUIPMENT

DOG/PET WASH



QUALITY PET CARE PRODUCTS

KLEEN-PET™

- Made specially for dog wash units!

5 GALLON		1 GALLON	
PRICE	PART #	PRODUCT	PRICE
\$102.27	PTW230	Tub Cleaner	\$20.45
\$63.54	PTW215	Tearless Shampoo (Ready To Use)	\$15.88
\$119.47	PTW200	Tearless Shampoo (Concentrate)	\$27.64
\$124.18	PTW232	De-Skunk	\$29.34
\$106.07	PTW201	Oatmeal Treatment Shampoo	\$22.28
\$144.00	PTW231	Veterinary Grade Shampoo	\$28.79
\$69.19	PTW202	Conditioner	\$16.83

TOP SELLER!



TUB SIDES GRAPHICS DECAL



CABINET INSTRUCTION DECAL

DOG WASH TUB DECAL PACKAGE

KLEEN-PET

- Includes (2) side tub decals and (1) back tub decal

\$117.99 PTW127



DOG WASH BANNER

KLEEN-PET

- 14' W x 2.5' L heavy duty banner for long-term outdoor display
- With mounting grommets

\$277.78 PTW141



DOG WASH WINDMASTER

KLEEN-PET

- 28" x 44" windmaster sign

\$66.99	PTW145	Sign
\$270.91	CH2002	Stand Only



Kleen-Rite now offers financing through QuickSpark. Get financing for detailing equipment and more today!



SELF SERVE EQUIPMENT

DOG/PET WASH PARTS & ACCESSORIES



PET VAC

PET WASH SUPPLIES & PARTS

- Removes water quickly
- Mesh basket separates hair from waste water
- Drain valve allows for easy draining of separation tank
- Keeps bay cleaner/ eliminates flying pet hair
- 110V AC

\$1,281.85 PTW110

REPLACEMENT MOTOR ONLY FOR HEAVY DUTY 2 MOTOR DRYER JR.

PET WASH SUPPLIES & PARTS

\$120.87 VAL5923 Replacement Motor



REPLACEMENT NOZZLE FOR DRYER

PET WASH SUPPLIES & PARTS

\$24.00 PTW106



RESTRAINING NOOSES 3 PIECE SET

PET WASH SUPPLIES & PARTS

- 18", 16" & 14" long

\$47.50 PTW131



CHROME HANGER FOR SHOWER HEAD

PET WASH SUPPLIES & PARTS

\$55.92 PTW113 2 Prong
\$65.92 PTW114 Single Prong



HANDLE FOR SHOWER HEAD

PET WASH SUPPLIES & PARTS

\$33.61 PTW119



STRAINER

PET WASH SUPPLIES & PARTS

\$81.05 PTW163

FLEXIBLE 8' WASH HOSE ASSEMBLY

PET WASH SUPPLIES & PARTS

\$149.14 PTW120



HOSE ASSEMBLY FOR HEAVY DUTY DRYER - 10 FT.

PET WASH SUPPLIES & PARTS

- Includes dryer nozzle

\$108.75 PTW105



HEAVY DUTY WARM AIR DRYER

PET WASH SUPPLIES & PARTS

\$519.56 PTW101



DOG WASH TOKENS

PET WASH SUPPLIES & PARTS

CALL PTW139



RESTRAINING CABLE WITH 3 LEASHES

PET WASH SUPPLIES & PARTS

- Leash sizes: 7", 14", 21"

\$36.67 PTW129-3



HEAVY DUTY SHOWER HEAD ASSEMBLY

PET WASH SUPPLIES & PARTS

\$102.35 PTW121



SHOWER HEAD REPLACEMENT PARTS

PET WASH SUPPLIES & PARTS

\$31.44 PTW116



BLENDING VALVE

PET WASH SUPPLIES & PARTS

- 80-120°F, 3/4"

\$153.20 PTW126



PET BRUSH CLAW FOR PET WASH VACUUM

PET WASH SUPPLIES & PARTS

- Small teeth on this claw grab all of hair from pets and guide it into the vacuum hose.

\$19.34 PTW110C

SELF SERVE EQUIPMENT

DOG/PET WASH VENDING



DECAL ONLY



DOG WASH VENDING MACHINE

PET WASH SUPPLIES & PARTS

- Stainless steel
- Large decal
- Push button selection
- Sensortron coin acceptor
- Stainless steel lock bar/frame
- 3 column electronic vending machine
- Digital display readout
- 24V operation
- Individual price programming

\$1,624.13	VEL899MAX	3 Column Vending Machine
\$2,017.27	VEL899MAXC	3 Column Vending Machine with Credit Card Swiper
\$20.99	PTW128	3 Column Decal - Overlays Available



FLAVORED DOG TREATS

PET WASH SUPPLIES & PARTS

- 1 oz. package - 100 packages per case
- **PEANUT BUTTER TREATS:** Barley flour, palm oil, honey, rolled oats, peanut butter, oat flour, coconut oil, flax, peanut flour
- **CHEESE & BACON TREATS:** Barley flour, palm oil, honey, rolled oats, cheddar cheese, flax, coconut oil, natural bacon flavor

\$84.38	PTW175-PB	Peanut Butter & Honey Treats
FREE	PTW175-PB-0	Peanut Butter & Honey Treats Overlay

\$84.38	PTW175-CB	Cheese & Bacon Treats
FREE	PTW175-CB-0	Cheese & Bacon Treats Overlay



WAFFLE WEAVE TOWEL

PET WASH SUPPLIES & PARTS

- 12 per case
- 17" x 26"

\$21.57	VS171	Towels
FREE	PTW190	Overlay



RAINWIPES® MICROFIBER TOWEL

PET WASH SUPPLIES & PARTS

- Dries 10x faster than regular rags

\$70.39	PTW600	12" x 16" (100/case)
\$132.00	PTW610	24" x 16" (100/case)



THE ORIGINAL SHAMMY

PET WASH SUPPLIES & PARTS

- 120 per case - individually wrapped
- 12.5" x 16.75"
- Assorted orange, blue & yellow
- Holds up to 21 times its weight in liquid
- Machine washable & bleachable

\$135.19	SHAM100	120/case
FREE	DEDS100	Overlay
FREE	VE0152	Single Col. Decal



TERRY CLOTH DRYING TOWEL

PET WASH SUPPLIES & PARTS

- 100 per case, folded & wrapped
- Super large, absorbent & reusable
- 100% cotton

\$57.52	VSKTT100W	Towels
FREE	DEDSKRTT	Overlay



FOLDING PET BRUSH

PET WASH SUPPLIES & PARTS

- 24 brushes per case

\$64.08	PTW130
----------------	---------------



RAIN PONCHO

PET WASH SUPPLIES & PARTS

- 25 per case
- Adult size

\$37.68	PTW170	Poncho
FREE	PTW170D	Overlay

SELF SERVE EQUIPMENT

FREEZE PREVENTION

EASYHEAT[®]

EASY HEAT SELF REGULATING PIPE HEAT SYSTEM

FREEZE PREVENTION

HOW IT WORKS:

- A special self-regulating core is at the center of the Freeze Free cable. This core is conductive and adjusts according to the surrounding temperatures. When it is cold, the cable's core has many conductive paths that generate enough heat to keep the water flowing in the pipe.
- Grounded 30" cord-set requires less heating cable
- Power indicator light
- Built-in, fast-reaction fuse
- Easy to install



HOW TO CALCULATE THE EXACT HEATER LENGTH YOU NEED:

Multiply the cable length required per foot of pipe by the length of your pipe. Add one extra foot for each valve located in your line. Maximum cable length is 75 feet.

$$\text{Cable length required per foot of pipe} \times \text{pipe length} + \text{one foot for each valve or spigot} = \text{total cable length}$$



EASY HEAT CONNECTION KIT

FREEZE PREVENTION

- Includes plug & end seal

\$23.52 **EH58252K**



EASY HEAT FREEZE-FREE CABLE

FREEZE PREVENTION

- Sold per foot

\$2.64 / FT. **EH58250**



EASY HEAT PRESET THERMOSTAT

FREEZE PREVENTION

\$28.25 **EH58299**



SUBZERO ANTI-FREEZE SYSTEM

HYDRO-SPRAY FREEZE PREVENTION

STANDARD FEATURES:

- Simultaneous Anti-freeze/blowdown
- Customizable Operating Parameters
- No Water Weep
- Digital Display Thermostat
- Idle Repeat
- Auto Blowdown
- Manual Blowdown
- Auto Anti-Freeze
- PLC Controlled
- Auto Reset
- Pre-Plumbed
- Pre-Wired
- 1 to 7 bay configurations

BENEFITS:

- Services All Types of Exposed Fluid Lines
- Green for the Environment
- Ease of Installation
- Plug & Play
- Piece of Mind
- Lower Water & Sewer Cost
- Fail-safe Protection
- Minimize Ice Build Up

NO MORE WEEPING!

Simply a Green, Efficient, Cost Saving, Peace of Mind for Freeze Control!

SUBZERO SPECIFICATIONS:

- INPUT VOLTAGE - 120 VAC 60Hz
- CURRENT CONSUMPTION - 2 AMPS (MAX)
- WATER REQUIREMENTS - 1/3 GPM Per Nozzle (Used when water weep is active)
- AIR REQUIREMENTS - 5.7 CFM • AIR PRESSURE RANGE - 0 PSI to 80 PSI (Set through Pressure Gauge)
- ANTI-FREEZE REQUIREMENTS - Recommended Propylene Glycol or Ethylene Glycol
- FLOJET OPERATING PRESSURE RANGE - 20 PSI to 80 PSI (Max Operating Pressure = 80 PSI) (Max Operating Temperature = 120°F)
- POLY TUBE MAX WORKING PRESSURE - 120 PSI
- RECOMMENDED AIR PRESSURE RANGE FOR BLOWDOWN - 25 PSI to 65 PSI
- RECOMMENDED AIR PRESSURE RANGE FOR ANTI-FREEZE PUMP - 25 PSI to 65 PSI

HYDRO-SPRAY
HYDRO SYSTEMS, INC.

CALL FOR PRICING - PACKAGES AVAILABLE FOR 1-7 BAY CONFIGURATIONS

SELF SERVE EQUIPMENT

DIXMOR

FREEZE PREVENTION



DIXMOR WEEP MIZER FREEZE PREVENTION

- The DX1000 is a microprocessor controlled system which will automatically cycle your existing normally open solenoid valve (normally closed optional), depending on outside temperature. When it starts it only runs water for a few seconds and as the temperature drops it automatically stays on longer and longer until it finally stays on 100% of the time. This is all controlled by the settings you program into the unit, or you may use the built-in program. You may wish to install sensors in two locations and the Weep Mizer will automatically operate from the coldest one.
- Cycles your weep system on and off for maximum dollar savings
- Continuous display of outside temperature for your convenience
- Use of multiple sensors possible; weep system controlled with coldest reading
- Battery backup to eliminate reprogramming in case of power failure
- Built in "FAIL SAFE" program for peace of mind operation
- Easily programmable with two push buttons
- Maintains memory of what time temperature was below turn on point, time water actually ran, in hours, high/low temperature since last reset.

\$406.99

TIO100

NEW REPLACEMENT SENSOR

FREEZE PREVENTION

- New yellow sensor included - 50 Ft. Length
- **WILL NOT WORK ON THE ORIGINAL WEEP MIZER**

\$39.99

TISENSOR-10

FOR WEEP MIZERS PURCHASED AFTER 2/22/10



ORIGINAL REPLACEMENT SENSOR

FREEZE PREVENTION

- Will need the original gray sensor
- 50 Ft. Length

\$39.99

TISENSOR

FOR WEEP MIZERS PURCHASED BEFORE 2/22/10



THE WINTERTIME CAN BE THE MOST PROFITABLE TIME OF YEAR FOR CAR WASH OPERATORS. KEEP AN EYE OUT FOR THE THINGS THAT CAN CAUSE YOU HEADACHES AND DOWNTIME IN THE BUSY COLDER MONTHS.

TIPS TO AVOID A COSTLY FREEZE AT YOUR WASH

- Make sure your weep system is working properly.
- Check the controls, be it a Weep Mizer or thermostat, to make sure it's reading the temperature correctly and sending power to the weep solenoid.
- Check the normally open solenoid to make sure it functions properly, and check to make sure your guns are allowing adequate weep water through.
- If you have floor heat, ensure your zones are heating adequately. Check the pressure of your floor heat system and add anti-freeze if needed.

SELF SERVE EQUIPMENT

LOW PRESSURE SYSTEMS



WALL MOUNT TRIPLE FOAM SYSTEMS EQUIPMENT

- Attract new customers with a thick, foamy, colorful, and high fragrance clear coat polish. The compact wall mount units are easy to install. Systems come completely assembled.
- Stainless steel product tank
- 506 Hydrominder
- FloJet pump
- Solenoid manifolds for air and product
- Stainless steel wall mount panels
- Electrical enclosure with controls
- Air regulator with gauges

PRICE	PART #	BAYS
CALL	TFS1BAY	1
	TFS2BAY	2
	TFS3BAY	3
	TFS4BAY	4
	TFS5BAY	5
	TFS6BAY	6

4 BAY SYSTEM SHOWN

FREE CHEMICAL START UP PACKAGE

KLEEN-RITE CHEMICALS

PART #	DESCRIPTION	DILUTION
KRC281	Polish- Blue	300-600/1
KRC282	Polish- Pink	300-600/1
KRC283	Polish- Yellow	300-600/1
KRC284	Detergent- Blue	300-600/1
KRC285	Detergent- Pink	300-600/1
KRC286	Detergent- Yellow	300-600/1

STAINLESS STEEL WALL TANK MOUNTED TANKS

- Available in single, double, & triple
- 3/4" outlet fitting
- Wall mounting brackets attached to tank

\$419.89	TA0160	Single Tank
\$527.91	TA0110	Double Tank
\$652.05	TA0130	Triple Tank
\$177.58	TA0224	Stainless Steel Wall Tank
\$46.69	TA0224B	Stainless Steel Bracket
\$29.74	TA0224L	Lid Only for Tank

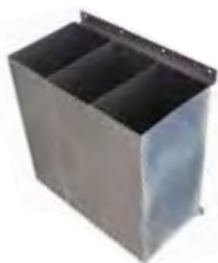

TA0130

24" x 24" x 12"



TA0224

12" x 6" x 10"

SHOWN WITH BRACKET, ALL PARTS SOLD SEPARATELY



WALL MOUNT PANEL LOW PRESSURE SYSTEMS EQUIPMENT

- FOAM BRUSH, TIRE CLEANER, PRESOAK, LOW PRESSURE WAX, BUG OFF
- Complete low-pressure system for foam brush or low pressure system single function of your choice. Easily retrofits into any existing car wash system. Completely prewired and pre-plumbed with detailed instruction manual.
- Stainless steel product tank
- 506 Hydrominder
- FloJet pump
- Air regulator with gauges
- Solenoid manifolds for air and product
- Stainless steel wall mount panels

PRICE	PART #	BAYS
CALL	LPS1BAY	1
	LPS2BAY	2
	LPS3BAY	3
	LPS4BAY	4
	LPS5BAY	5
	LPS6BAY	6

7 BAY SYSTEM SHOWN

MULTI-PURPOSE FOAM GENERATOR REPLACEMENT PARTS

- PVC construction
- Maintenance free - no plug design
- Dual & Single 3/8" Push Lock Inlet
- Single 3/8" Push Lock Outlet



TFSA001

7.5" MULTIPURPOSE FOAM GENERATOR

REPLACEMENT PARTS

\$48.11 TFSA001

11.5" MULTIPURPOSE FOAM GENERATOR W/ DUAL INLETS

REPLACEMENT PARTS

\$81.89 TFSA005



EACH UNIT COMES WITH
A FREE CHEMICAL START UP PACKAGE!

START UP PACKAGE INCLUDES:
KLEEN-RITE BLUE, PINK, AND YELLOW TRIPLE FOAM

SELF SERVE EQUIPMENT

PREP UNITS

BACK VIEW

FRONT VIEW



HIGH-PRESSURE DUAL PREP GUN UNIT

PREP UNITS

• This high-pressure dual gun prep system will meet the demands of your high-volume tunnel. We designed the unit to meet all of your expectations. It is powerful, reliable and most importantly, affordable. The unit can be purchased with or without the motor controls.

FEATURES:

- Stainless steel stand
- 530 Hydrominder
- 7.5 HP Baldor® motor
- Dual gun ready
- Poly tank & lid
- CAT Pumps® 7CP pump (8 GPM @ 1250 PSI)
- Belt driven
- Unloader & pulsation dampener

\$7,485.94	PS7CP	Dual Prep Gun Stand
\$789.71	PS7CP-CB	Control Box

SHOWN WITH OPTIONAL MOTOR CONTROL

CHEMICAL STORAGE TANK
SOLD SEPARATELY



PUMP STAND

VARIABLE FREQUENCY DRIVE PUMP STAND

PREP UNITS

FEATURES:

- 7 speed/pressure combinations
- All high & low pressure functions go through the pump (except foam brush & triple foam)
- Space saving 2 stack/all stainless steel pump stand
- Standard with CAT Pumps® 310 Pump - other models can be specified
- Baldor motor & variable frequency drive
- 3 stack rotary switch required
- State of the art car washing technology

CALL FOR PRICE	PSVFD310	Pump Stand
	PSVFDTANK	Storage Tank

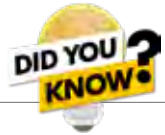

YOU CAN MAKE A CUSTOM "FAVORITES" LIST ON THE KLEEN-RITE WEBSITE!

Create your custom list based on products you frequently order, then when you need more products you can shop right from the list - no searching needed!



STAINLESS STEEL HIGH PRESSURE PUMP UNIT

PUMP UNITS & STANDS

- COMPLETELY PRE-PLUMBED & PREWIRED. ASSEMBLED READY TO GO BAY UNITS.

STANDARD UNIT AS SHOWN:

- Baldor 5HP, 3PH Motor
- CAT Pumps 310 Pump, Regulator & Pulsation Dampener
- Stainless Steel Soap & Wax Solenoids
- 3 way valve setup for hot wash & cold rinse
- Weep Plumbed
- Motor Starter, Transformer, Counter, Hour Meter, 2 Belt Pulleys & SS Belt Guard
- Unit can be customized to your specifications

CAT PUMPS® 310 PUMP

PUMP UNITS & STANDS

PS310	One Pump Unit
PS310-2	Two Pump Unit
CALL FOR PRICE	

CAT PUMPS® 530 PUMP

PUMP UNITS & STANDS

PS530	One Pump Unit
PS530-2	Two Pump Unit
CALL FOR PRICE	

SECURITY SYSTEMS



NOW AVAILABLE FOR YOUR IPHONE, IPAD OR DROID!

HIGH DEFINITION DVR SYSTEMS

TURBO WASH DVR

- What makes Turbo Wash DVR unique is that it offers a complete integrated digital surveillance system to meet a wide range of digital security needs: HD 4K (8 MP) 5 Megapixel (5MP), 4 Megapixel (4MP) 1080P (2MP), Analog video, Starlight/Starvis night vision cameras, HD license plate cameras and management software - all integrated on the internet with CMS, mobile device and web browser access. In short, we provide a total security system that is fast, secure, reliable, cutting-edge, easily storable and retrievable digitally on any internet connected PC, while providing the most cost-effective and technically advanced surveillance systems on the market.

HIGH DEFINITION DVR MODELS

TURBO WASH DVR

* California PROPOSITION 65

- 4, 8, 16, 32 channel models that are hybrid supporting AHD/TVI/CVI/CVBS/Analog video
- H.265 Compression
- **COMPETENT ALL HYBRID SYSTEM:** Simultaneously connect 4K (8MP), 5MP, 4MP, 2MP, AHD, TVI, CVI, CVBS, (4 Channel DVR supports one 4K camera)
- **INTERFACE:** Intuitive, stable and user-friendly embedded system
- **MOBILE VIEW:** Mr. Patrol for iPad/iPhone/Android

PRICE	PART #	MODEL	STORAGE
\$647.02	TWAST04 *	4 Channel	2 TB
\$950.54	TWAST08 *	8 Channel	4 TB

PRICE	PART #	MODEL	STORAGE
\$1,571.38	TWAST16 *	16 Channel	6 TB
\$3,495.00	TWAQ32	32 Channel	12 TB

4K TO 1080p

TWAHD16CDVR - PREMIUM 16 CHANNEL DVR PACKAGE - 6 TB DRIVE

TURBO WASH DVR

- 1 - TWAST16 - 16 channel all hybrid HD DVR
- 1 - 16 channel 12 volt power supply box
- 1 - HD BNC connector CAP Kit-1 (32 pcs)
- 8 - TW500ESLW - Sony 5mp Starvis back illuminated sensor
- 2 - Siamese video/power cable 500'
- 8 - Power pigtail connector for camera including gel filled crimps

\$3,325.50 **TWAHD16CDVR**

8 CAMERAS
5 MEGA PIXEL EACH

TWAHD8CDVR - PREMIUM 8 CHANNEL DVR PACKAGE - 4 TB DRIVE

TURBO WASH DVR

- 1 - TWAST08 - 8 channel all hybrid HD DVR
- 2 - 4 channel 12 volt power supplies
- 10 - BNC CAP connector including tools
- 5 - TW500ESLW - Sony 5mp Starvis back illuminated sensor
- 1 - Siamese video/power cable 500'
- 5 - Male & female power pigtail connector for camera including gel filled crimps

\$2,203.39 **TWAHD8CDVR**

5 CAMERAS
5 MEGA PIXEL EACH



SECURITY SYSTEMS

New!



VANDAL PROOF DAY/NIGHT MOTORIZED/AUTO FOCUS 2.7 13.5MM VARIFOCAI CAMERA WITH SONY STARVIS IMAGE SENSOR

TURBO WASH DVR

• A great camera for viewing vehicles at tunnel entrance or any area that requires the highest detail. High quality color images due to the Sony Starvis back-illuminated sensor. This is a multi-switchable AHD/TVI/CVI/CVBS HD waterproof camera.

SPECIFICATIONS:

- 2.7-13.5mm Motorized Zoom & Auto Focus
- 4 in 1 AHD/TVI/CVI/Analog Up
- Varifocal
- 12 VDC
- Switchable to 4K or 5MP Traditional CCTV
- Auto Exposure
- Weatherproof IP67
- Single angle adjustment in seconds
- Auto White Balance
- Vandal-proof
- Built-in IR-LED or LED Warm light
- 1/2.9 Sony Starvis back-illuminated starlight sensor
- Electronic Shutter

\$190.59 TW5008ESWL Effective Range 30M | 4K/5MP Sensor

VANDAL PROOF DAY/NIGHT 5MP 2.8MM FIXED LENS CAMERA WITH SONY STARVIS IMAGE SENSOR

TURBO WASH DVR



• Reliable camera for monitoring car wash bays! Up to 5MP HD resolution means high-quality video recording to keep tabs on your car wash facility. Color Functions perfectly any time of day or night with full color warm light IR and the Sony Starvis back-illuminated sensor for incredible night images. The warm light infrared will allow the camera to see in total darkness. Specially designed to be vandal-proof with auto-adjustments to white balance and exposure for maximum efficiency and convenient, hands-free operation

SPECIFICATIONS:

- 4 in 1 AHD/TVI/CVI/Analog Up to 5MP high definition
- Switchable to 960H traditional CCTV
- Auto white balance
- 2.8mm fixed lens
- Simple angle - Adjustment in seconds
- Weatherproof IP67
- 1/2.9 Sony 5MP Starvis back-illuminated CMOS sensor
- Built-in warm light full color LED, effective range 25m
- Auto exposure
- Electronic shutter
- Vandal-proof
- 12 VDC

\$168.24 TW500ESLW

VANDAL-PROOF INFRARED DAY/NIGHT CAMERA

TURBO WASH DVR



• Reliable camera for monitoring car wash bays! High-definition resolutions means high-quality video recording to keep tabs on your car wash facility. Functions perfectly during any time of day or night. Specially designed to be vandal-proof with auto-adjustments to white balance and exposure for maximum efficiency and convenient, hands-free operation!

SPECIFICATIONS:

- 4 in 1 AHD/TVI/CVI/Analog High Definition
- 1/2.8 Sony Starvis back-illuminated CMOS sensor
- Switchable to 960H traditional CCTV
- Built-in IR-LED, effective range 20m
- Auto white balance
- Auto exposure
- 2.8 mm fixed lens
- Electronic shutter
- Simple angle - adjustment in seconds
- Vandal-proof
- Weatherproof IP66
- 12 VDC / 550mA

HD 2MP (1080P) & 960H

\$138.82 TW200ESL 2MP, 1080P

TURBO WASH DVR PARTS & ACCESSORIES

CONNECTORS, TOOLS & KITS

TURBO WASH DVR



TWBNCC



TWPICAP



TWPTL

\$1.64	TWBNCF	Female BNC
\$3.21	TWPTL	Power Pigtail Connector
\$3.36	TWCBNC-HD	HD CAP BNC Male Connector with Black CAP
\$8.53	TWSPC	CAP Stripping Tool
\$12.69	TWPICAP	Pliers for CAP System
\$116.47	TWCAPKIT-1	CAP BNC-HD Small Kit with 32 BNC-HD
\$162.35	TWCAPKIT-2	CAP BNC-HD Medium Kit with 50 BNC-HD



SECURITY SYSTEMS



SIAMESE VIDEO CABLE
TURBO WASH DVR

\$170.00 TWKABLE500



BNC CAP KIT
TURBO WASH DVR

Kit of CAP system parts. Uses a non-metallic female connector. CAP system is designed to make every coaxial termination simple, quick and reliable and to drastically reduce all typical problems that arise when terminating coaxial cables. CAP is used with Turbo Wash's specific adapters and becomes a connector usable in all existing coaxial standards.

INCLUDES:

- 32 Pieces | Connectors | Tools | Pliers | Case

\$116.47 TWKAPKIT-1



HOUSING MOUNT
TURBO WASH DVR

\$22.67 TW205



18 CHANNEL, 12V POWER SUPPLY
TURBO WASH DVR

\$164.71 TWDC18

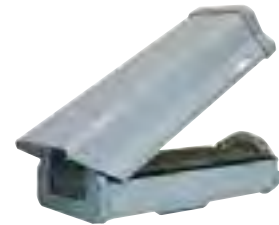

OUTDOOR HOUSING
TURBO WASH DVR

\$40.00 TW605

COIN COLLECTION SYSTEMS & REPLACEMENT PARTS



CENTRALIZED COIN COLLECTION SYSTEMS

VAC-IT-UP

• Self-serve car wash operators can now take advantage of this innovative coin collection system. It's quick and easy to unload. It features a new tilt-out coin storage canister designed to pour the coins right from the canister into your money bag. The legs are secured to a concrete floor and the back is secured to the wall. PVC piping goes from the VAC-IT-UP to your bays, or vacuum islands. The coins are vacuumed up through the piping to the canister, eliminating theft at the meters. VAC-IT-UP is only activated when quarters are inserted in the meters (first coin activation).

ELECTRICAL REQUIREMENTS:

- Provide one 120 Volt AC 30 amp circuit to control panel for every two Vac-It-Up motors

SPECIFICATIONS:

- Vault Chamber: Heavy gauge steel
- Vault Door: Stainless steel
- Lock: Medeco
- Coin Canister: Vault equipped with hinged coin storage canisters which hold \$1,500 worth of quarters each

OPTIONAL ITEMS:

1. Timer control panel
2. Access Box
3. Roof top motor housing

SECURITY ADVANTAGES

- Centralize Coin Collection
- Reduces attempted vandalism & theft
- Privately housed, Labor efficient



REPLACEMENT VAULT MOTOR
REPLACEMENT PARTS

\$132.66 VAL6472

PIPES	CANISTER	APPROX. LBS.	SIZE	TOTAL \$ CAPACITY
2 Pipe System	2	170 lbs.	76" x 17¾" x 10½"	\$3,000
3-4 Pipe System	2	170 lbs.	76" x 17¾" x 10½"	\$3,000
5-6 Pipe System	3	230 lbs.	76" x 26½" x 10½"	\$4,500
7-8 Pipe System	4	340 lbs.	76" x 63" x 10½"	\$6,000
9-10 Pipe System	5	400 lbs.	76" x 45" x 10½"	\$7,500
11-12 Pipe System	6	400 lbs.	76" x 45" x 10½"	\$9,000

CALL FOR PRICING

HIGH SECURITY "VAULT" WITH MOTOR COMPARTMENT

Constructed of heavy gauge steel and sealed with a continuous electrical weld. The door is stainless steel with a Medeco lock.

OPTIONAL TIMER CONTROL PANEL

Complete enclosure with motor "test" buttons

COIN COLLECTION SYSTEM PARTS

REPLACEMENT PARTS

VACITUPBOX	Overhead U-Trap 12" x 12" x 5"
VACITUPBOX-U	Underground P-Trap Access Box
VACITUPBOX1	Overhead U-Trap 12" x 12" x 12"
VACITUPFLAPPER	Coin Vault Flapper with Rivets
VACITUPGAS	Gasket Material (Price Per Foot)
VACITUPPIPE	J-Pipe

FEATURED PRODUCT



COST EFFECTIVE, SECURE, AND EASY TO INSTALL & CONFIGURE

The CryptoPay Payment System is a wireless system that consists of a CryptoPay Coordinator, an Online Program called MyCryptoPay, and one or more CryptoPay payment devices.



Contactless payments are rapidly becoming the preferred method of payment. To meet this contactless payment demand CryptoPay has developed, and added to our product family, CryptoTap Plus and CryptoTap Standard. Both products support contactless credit and debit cards, Apple Pay, Samsung Pay, Google Pay and others.



Just Tap & Go!

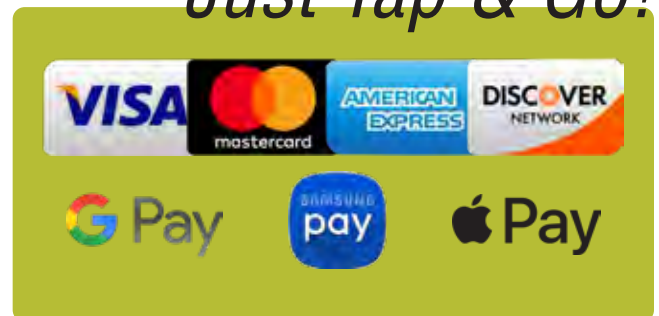

ACCEPTING CREDIT CARDS AT A SELF-SERVE OR AUTOMATIC CAR WASH IS A GROWING TREND...

The benefits seem to be obvious; credit card customers will add new revenue, credit card customers spend more money, the younger generation doesn't carry cash, and so forth. So why aren't car wash owners getting on the bandwagon by accepting credit cards?

NEW PRODUCTS

Features and Benefits:



CryptoTap Plus (Contactless Payment Device)

- Stand-alone Tap Unit with smaller footprint, allows mounting in most coin boxes
- Outputs connect directly to Dixmor Timer
- All transactions are EMV
- Built in QR reader
- Brilliant color LED's surround tap unit
- CryptoTap Plus Works with contactless credit and debit cards
- CryptoTap Plus works with mobile payments including Samsung Pay, Apple Pay, Google Pay, and others
- No wireless fees / No minimum quantities

CryptoTap Standard (Contactless Payment Device)

- Easy two wire installation
- Pairs with CryptoPay swiper
- Fast, safe, secure payment
- CryptoTap Standard works with contactless credit and debit cards
- CryptoTap Standard works with mobile payments including Samsung Pay, Apple Pay, Google Pay, and others
- No wireless fees / No minimum quantities



CHECK OUT OUR YOUTUBE VIDEO OF CRYPTOTAP PLUS!



CREDIT CARD PAYMENT SYSTEMS

U.S. USE ONLY

CRYPTOPAY WIRELESS CREDIT CARD SYSTEM

- The CryptoPay Wireless Credit Card System reduces fees and secures your transactions. The system is composed of three main building blocks: The MyCryptoPay Online Program, CryptoPay Coordinator Unit, and one or more CryptoPay Swipers.
- The MyCryptoPay Online Program allows you to view recent purchases, configure your CryptoPay Swipers, and ensure your system is up and running remotely from your computer or mobile device.
- The CryptoPay Coordinator unit wirelessly and securely transmits to each of the CryptoPay Swipers. The Coordinator connects to the internet and authorizes and finalizes transactions, and is used to remotely re-configure the swipers. One coordinator is needed per wash location and supports many Swipers.
- The CryptoPay Wireless Swiper encrypts credit card data at the moment of credit card swipe and securely transmits the encrypted data. Encrypted data can only be decrypted by the Magensa Protected Payment Gateway. The Magensa Protected Payment Gateway is PCI-DSS certified and listed by MasterCard and Visa as a compliant service provider.
- The CryptoPay Wireless Credit Card System reduces fees and secures transactions.
- Engineered to reduce fees with CryptoPay Consolidation.
- Simple, which makes it affordable and easy to install - rugged enough to survive in a carwash environment.

\$374.99	CPS3000	CryptoPay Coordinator
\$399.99	CPS3005	CryptoPay Credit Card Swiper
\$374.99	CPS3005-10D	Vending Swiper for Laurel Drop Shelf - Call for Details and Machine Compatibility
\$399.99	CPS3005-15	CryptoPay Swiper (with out button) for vacuums
\$389.99	CPS3005-20	Vending Swiper for Glass Front Vending Machines - Call for Details and Machine Compatibility
\$424.99	CPS3005-25	Laundry Swiper with Power Adapter
\$6.50	CPS3010	CryptoPay Cat 5 Ethernet Cable
\$80.26	CPS3025	Locking Side Mount Box for Swiper
\$145.91	CPS3025-V	Side Mount Box for Vacuums - Cutouts for Dixmor LED7 timer and CryptoPay swiper

CRYPTOPAY HAS NEW SWIPERS FOR GLASS FRONT VENDING MACHINES & LAUNDRY!

- Supports MDB Level 2 machines and included a Daisy Chain Cable to connect to other MDB Devices

BEST PART?

- NO WIRELESS FEES
- CryptoPay Transaction Consolidation

CRYPTOTAP PLUS

- Small Footprint
- Stand Alone Unit
- Doesn't need to pair with a swiper
- Outputs pulse the wash timer directly
- Fully EMV
- QR/BCR Reader
- External Red and Green Button
- CryptoTap Plus Works with mobile payments including Samsung Pay, Apple Pay, Google Pay, and others
- No Wireless Fees / No Minimum Quantities

\$500.00	CPS3009	Count Up or Down - Replaces Standard Swiper, Most commonly used on Meter/Coinboxes & Vacuums, External Red and Green Button
\$500.00	CPS3009-MDB	Used on Laurel Dropshelf Vending Machines, No Button Needed
\$510.00	CPS3009-2MDB	Used on Mega-Vender & Raddatz Vendors, Includes MDB Split Cable

\$12.50	CPS3016	10" x 12" - Count Up Decal
\$12.50	CPS3016D	10" x 12" - Count Down Decal



CRYPTOTAP CONTACTLESS PAYMENT UNIT

- CryptoTap is a new contactless payment device from the makers of CryptoPay. With a simple wire hookup and three drilled installation holes, your car wash is ready to accept virtually any contactless payment types using phones and cards. This system must be used with the CryptoPay system, which includes a swiper and a coordinator. You can use it with your existing system or purchase new Cryptopay equipment. Customers will love the speed, convenience, and safety of contactless payment at your car wash business!

SPECIFICATIONS AND FEATURES:

- Dimensions: approximately 4" x 4"
- 24V power requirement
- Mount beside or very close to CryptoPay swiper
- Installs by connecting two 24V power wires and drilling three installation holes
- Once powered, it will pair with the CryptoPay network - true "plug-and-play"
- Fast, safe, secure payment with absolutely no contact
- Accepts Apply Pay, Samsung Pay, and almost all other contactless phone and card payment types
- PCI Compliant

\$350.00	CPS3008	CryptoTap
\$14.20	SIKR076	12" x 12" Sign
\$113.21	BANNER3814	3' x 8' Banner

New!

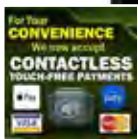

U.S. USE ONLY

CRYPTOPAY RETROFIT KITS

TOP SELLER!



GOLD LINE RETROFIT KIT - CPS3030



UNITEC WASH SELECT RETROFIT KIT - CPS3040

CRYPTOPAY RETROFIT KITS FOR HAMILTON GOLDLINE, ACW4, ACW5 & UNITEC WASH SELECT CRYPTOPAY

- Secure credit card processing at the point of credit card swipe
- Reduce card verification time utilizing broadband internet speed
- Reduce your fees with CryptoPay Consolidation
- Lexan Face Plate provides a fresh, clean, modern look
- GoGreen Online Receipt Service (Included for 1 year)

\$1,300.00	CPS3030	Retrofit Kit - Gold Line (Includes Lexan, Swiper, Red LED Display, Circuit Board, Hardware Kit, GoGreen Sign)
\$1,300.00	CPS3040	* Retrofit Kit - Unitec

BUTTONS SOLD SEPARATELY - HCP499305 (BLUE) & HCP499373 (RED)

*** VINYL DECAL (CPS3135) PROVIDED WITH UNITEC RETROFIT KIT**

CRYPTOPAY SIGNS AND DECALS



CPS3017T



CPS3017D

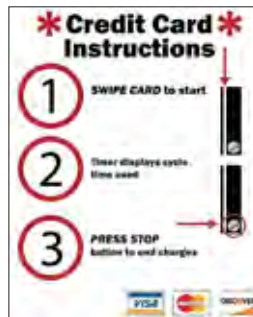

CPS3017



CPS3015



CPS3015D



CPS3015T

CRYPTOPAY INSTRUCTION SIGNS & DECALS

\$12.50	CPS3015	Count Up Sign - 10" x 12"
CALL	CPS3015C	Count Up Sign - 10" x 12" - Custom
\$12.50	CPS3015D	"Advanced" Count Down Sign - 10" x 12" For use with Dixmor Timers made after 2005
\$12.50	CPS3015T	Count Down Sign - 10" x 12" - Use with Dixmor Timers made before 2005 and all other count down timers

\$0.98	CPS3017	Count Up Decal - 4" x 5"
\$0.98	CPS3017D	Count Down Decal - 4" x 5" Use with Dixmor Timers made after 2005
\$0.98	CPS3017T	Count Down Decal - 4" x 5" - Use with Dixmor Timers made before 2005 and all other count down timers



New!

TAP TO PAY DECAL

- Pair with CryptoPay's CryptoTap Plus and CryptoTap units, the Monex UltraVX, Nayax readers, and more!

\$0.83	DE100	2" x 5.5" Peel-and-stick backing
---------------	--------------	----------------------------------

CREDIT CARD SYSTEMS

NAYAX VPOS-TOUCH ALL IN ONE GRAPHICAL PULSE CASHLESS PAYMENT SYSTEM FOR CAR WASH AND AIR AND VAC

NAYAX

- NAYAX offers exclusive and important revenue generating and costs savings features coming from the international engineering leader of cashless technology. NAYAX engineers and manufacturers the cashless devices and reporting software supporting systems on nearly 500,000 unattended machines in 60+ countries and works with 45 financial institutions worldwide, accepting 26 currencies. Why does this matter to customers? Because it allows NAYAX to exclusively offer many important money-generating and efficiency features at no additional cost. VPOS TOUCH ALL-IN-ONE GRAPHICAL DISPLAY DEVICE - Best in Class .

KEY EXCLUSIVE HIGHLIGHTS AND FEATURES:

- NEW ADDITION – Instant receipts
- Totally flexible price setting options built in: Count up | incremental | Count down | 6 prices
- EMV both chip and tap enabled *****(NO CHARGEBACKS)**** No swipe - EMV Both Chip and Tap Enabled and Fully 100% PCI Compliant – WITH NAYAX DEVICES WE ACCEPT THE MOST SECURE TRANSACTIONS WITH EMV CONTACT AND CONTACTLESS IN THE US. Nayax has been chip and wave card for 4 years in the US.
- Easy and inexpensive retro-fit on all older pay stations (Unitech, Hamilton, Exacta, etc.), meter boxes, vacuums, and air machines.
- Vandalism, water-resistant and has built-in graphical timer display
- Instant power up and power down alerts through the hardware allowing our customers to instantly know if their machine goes down or comes back up to prevent loss of sales.
- Nayax builds customer engagement into their hardware:
 - Nayax readers speak to the customer and guides them through the transaction by voice and says thank you when completed.
 - Monyx Rewards and Loyalty Wallet App – “Shake Me” feature will give your customers free money after every purchase and also gives a 10% bonus (a free \$2.50 for every \$25 the customer will spend)
- Easy plug-and-play installation – Works independently. Uses Verizon or AT&T Cellular for instant connectivity and if poor Cellular in a location, we have built in a LAN/Wifi Port for your convenience.
- Fixed Rate Low-Cost Processing – Easy flat fee statements - No dealing with complex Interchange Plus and the variable fees added on standard processing statements that force you to pull out a calculator every month to calculate your net fee each month.
- MOMA - Phone App to see sales from the ease and comfort of your cell phone.
- Integrated with the best Car Wash Specific Reward and Loyalty Apps in the market - Beacon Mobile and others coming soon
- Fleet Card System – Create your Own Gift Cards. Add Money as you desire. Autofill, carry over unused balances.
- Advanced hi-resolution graphical display allows you to brand the reader with your own graphics and messaging.
- Instant Receipts and Instant Refunds To Your Customers
- 99.9% uptime guaranteed uptime servers and multi language – switch between

\$399.00	VPOS-TOUCH	VPOS Cashless Payment System - Pulse Model
\$42.68	VPOS-TOUCH-C	Optional 24V power supply and cord for pulse model

NAYAX VPOS-TOUCH ALL IN ONE GRAPHICAL MDB CASHLESS PAYMENT SYSTEM FOR VENDING

NAYAX

- NAYAX offers exclusive and important revenue generating and costs savings features coming from the international engineering leader of cashless technology. NAYAX engineers and manufacturers the cashless devices and reporting software supporting systems on nearly 500,000 unattended machines in 60+ countries and works with 45 financial institutions worldwide, accepting 26 currencies. Why does this matter to customers? Because it allows NAYAX to exclusively offer many important money-generating and efficiency features at no additional cost. VPOS TOUCH ALL-IN-ONE GRAPHICAL DISPLAY DEVICE - Best in Class .

KEY EXCLUSIVE HIGHLIGHTS AND FEATURES:

- NEW ADDITION – Instant receipts
- (NO CHARGEBACKS)** No swipe - EMV Both Chip and Tap Enabled and Fully 100% PCI Compliant – WITH NAYAX DEVICES WE ACCEPT THE MOST SECURE TRANSACTIONS WITH EMV CONTACT AND CONTACTLESS IN THE US. Nayax has been chip and wave card for 4 years in the US.
- Vandalism and water-resistant
- Built-in graphical timer display
- Instant power up and power down alerts through the hardware allowing our customers to instantly know if their machine goes down or comes back up to prevent loss of sales.
- Nayax builds customer engagement into their hardware:
 - Nayax readers speak to the customer and guides them through the transaction by voice and says thank you when completed.
 - Monyx Rewards and Loyalty Wallet App – “Shake Me” feature will give your customers free money after every purchase and also gives a 10% bonus (a free \$2.50 for every \$25 the customer will spend)
- Easy Plug-and-Play Installation – Works independently. Uses Verizon or AT&T Cellular for instant connectivity and if poor cellular in a location, we have built in a LAN/Wifi Port for your convenience.
- MOMA - Phone app to see sales and adjust inventory from the ease and comfort of your cell phone
- Advanced hi-resolution graphical display allows you to brand the reader with your own graphics and messaging.
- Instant receipts and refunds to your customers
- 99.9% uptime guaranteed uptime servers and multi language – switch between
- NayaxVend - Full Inventory System with MDB Live Transaction in addition to Dex
- Accepts transactions in Pre-selection Mode to prevent customer angst and confusion so that customers do not get charged a constant pre-authorization higher amount than they paid.

\$353.75	VPOS-TOUCHM
-----------------	--------------------



It is highly recommended that this acceptor is installed by someone with previous knowledge of pulse to ensure proper operation.



CREDIT CARD SYSTEMS

MONEXgroup.com

ULTRAVX WATERPROOF UNATTENDED PAYMENT TERMINAL MONEXGROUP



- Durable payment device engineered to withstand rough conditions in car wash bays
- PCI Compliant: secure payment solution
- Online Dashboard: real-time monitoring
- Connectivity: WiFi with 1 Router / 1 SIM for all terminals on site, no cabling
- Ruggedized: waterproof, tamperproof, dirtproof, operates from -31 °F to +140 °F
- Accept All Payments: tap, insert, swipe and mobile devices
- Versatility for self-service or tunnel car washes: service mode, package mode, count up, count down, fixed price
- **H8951 ROUTER REQUIRED TO USE THIS TERMINAL**
- Metal Mounting Frame (PL210004) available - **SOLD SEPARATELY**

\$551.28	ULTRAVX	Acceptor
\$350.00	ULTRAVX-R	Router



PAYMENT TERMINAL METAL MOUNTING FRAME MONEXGROUP

- Designed for use with MONEXgroup UltraVX payment terminal
- 4.92" W x 7.09" H x 2.87" D
- Tough metal construction
- Conceals device for maximum protection

INCLUDES:

- Frame, plate, gasket, and 4 installation screws

\$136.00 **PL210004**



POWER RELAY IDX PAYMENT SYSTEMS



- Allows any timer to be a count up timer
- Power handling relay for count up credit card systems to handle the load required in the car wash, use with IDX Card Solution, CryptoPay, Unitec & other systems

\$42.81 **IDXMA79**

STORAGE TANKS

MOTORIZED MIXING TANK EQUIPMENT



SPECIFICATIONS:

- 55 gallon capacity
- 1/3 HP TEFC motor
- 115V AC
- Single phase
- Durable thick plastic
- 1/2" plastic lid
- Stainless steel hinge

\$1,569.61 **KRMT**



VERTICAL ROUND STORAGE TANKS

DEN HARTOG



- Vertical tanks are free standing with a flat bottom for indoor or outdoor installations. Tanks are manufactured from a medium or high density polyethylene with UV inhibitors. Tank walls are translucent for level viewing and are equipped with gallon indicators.

PRICE	PART #	CAPACITY	SIZE	FITTING
\$125.31	SVT0020	20 Gallon	16" D x 28" H	3/4"
\$104.64	SVT0025	25 Gallon	18" D x 30" H	3/4"
\$129.41	SVT0040	40 Gallon	18" D x 43" H	3/4"
\$186.71	SVT0065	65 Gallon	23" D x 42" H	1"
\$200.99	SVT0075	75 Gallon	23" D x 50" H	1"
\$269.49	SVT0100	100 Gallon	28" D x 45" H	1"
\$373.94	SVT0210	210 Gallon	40" D x 49" H	2"



BULK HEAD FITTINGS EQUIPMENT

\$5.77	TA0310	1/2" PVC
\$5.95	TA0315	3/4" PVC
\$6.86	TA0320	1" PVC
\$10.45	TA13118	1/2" Brass
\$8.33	TA13121	3/8" Brass



WATLOW STAINLESS STEEL 1" TANK HEATER WITH THERMOSTAT EQUIPMENT

\$243.03	WH0500-120	120V	Heats to: 230°F
\$248.44	WH0500	240V	Heats to: 110°F

OPEN TOP SQUARE STORAGE TANKS

CHEM-TAINER EQUIPMENT

- Polyethylene tanks for chemical storage
- Translucent for visible contents level. Rated to 140°F
- Lids included on most models, indicated where **SOLD SEPARATELY**

PRICE	PART #	CAPACITY	SIZE
\$134.00	SOT0005	5 Gallon	10" W x 16" L x 8" H
\$76.00	SOT0005V	3 Gallon Vertical	6" W x 12" L x 12" H
\$140.70	SOT0011	11 Gallon	12" W x 12" L x 18" H
\$176.88	SOT0022	22 Gallon	12" W x 24" L x 18" H
\$194.30	SOT0037	37 Gallon *	18" W x 24" L x 18" H
\$581.56	SOT0040	40 Gallon Open Top *	18" W x 30" L x 18" H
\$124.62	SOT0040LID	Lid for 40 Gallon Open Top	-



WALL PANELS

PVC DOORS WITH PANELS



CAR WASH WALL & CEILING PANELS

EPI/EXTRUTECH



CUSTOMIZED TO FIT YOUR CAR WASH NEEDS!

- Standard size - 12", 16", and 24" panel widths - cut to the inch from 3'-20' lengths

FEATURES:

- Waterproof and rot-proof - for use on interior walls and ceilings. Maintenance-free, easy to clean, durable.
- Brightens the interior for a fresh clean appearance that quickly sheds water
- Tongue and groove design, installs quickly and easily with no exposed fasteners
- Meets Class A for smoke and flame spread, ASTM E84-09 and CAN/ULC S102.2-3, ICC ESR-4583
- 20-Year Warranty on wall and ceiling liner panels
- Rustproof PVC doors also available
- Trims available at 8', 10', 12', 14' & 16' lengths

EPP1300	1/2" x 12" White Flat Panel (per ft)
EPP1300SS	1/2" x 12" Flat Panel - Beige
EPP1600	1/2" x 16" Flat Panel - White
EPP2400	1/2" x 24" Flat Panel - White
EPP3000	1/2" White Beaded Panel (per ft)
EPP0100	1/2" White J-Trim (per ft)
EPP0270	Floor Cove, Inside Corner Trim
EPP0220	1/2" White Outside Corner (per ft)

EPP0231	Large H-Bar (per ft)
EPB0350	3.5" x 5/8" Foam Board (per ft)
EPB0550	5.5" x 5/8" Foam Board (per ft)
EPC0100	Window Sill (per ft)
EPWM356	Colonial Casing (per ft)
EPWM390	Chair Rail (per ft)

CALL FOR PRICING

IN-BAY AUTOMATIC



2 1/4" PARTITION WALL PANEL SYSTEM

EPI/EXTRUTECH



- Smooth wall panel with a bright-white, glossy surface on both sides. This panel is waterproof, will never rust, rot, corrode, or fade. The panel is easy to clean and ideal for high-moisture areas where daily sanitation is critical.

BENEFITS/FEATURES:

- Sanitary - easy to clean
- Low-maintenance
- Ideal for high-moisture area
- Waterproof - no rot or rust
- Highly reflective
- 15-year warranty
- Stain-resistant
- Installs quickly and easily

EPP0224	2 1/4" x 24" W Linear Wall Panel	3'-24' Lengths
EPP0224-I	2 1/4" x 24" W Linear Wall Panel, Insulated	3'-24' Lengths
EPP0125	U-Channel for P224 Wall Panel	16'

EPP0225	Fitted Corner for P224 Wall Panel	8', 16'
EPP0226	Slip-On Corner for P224 Wall Panel	8';9';16';18'

CALL FOR PRICING

SELF-SERVICE



OTHER COLORS AVAILABLE!
(Color Panel Available in 1 Ft. Widths Only)

BEADED PANELS ARE IDEAL FOR CEILINGS
(EPP3000)

SMOOTH LINER PANELS ARE PERFECT FOR WALLS & CEILINGS
(EPP1300, EPP1600, EPP2400)

PARTITION WALL PANELS ARE PERFECT FOR AREAS WITH HIGH MOISTURE CONTENT
(EPP0224, EPP0224-I)

WALL CLEANERS

IT WORKS NATIONAL



- 5-Gallons
- Ratios: straight - 20:1
- Spray on with low pressure and spray off with high pressure
- A powerful liquid detergent designed for cleaning plastic wall panels

\$55.35 NAP5408



KLEAN WALL AP FORMULATORS



- 5-Gallons
- Spray on, rinse off
- Makes the dreaded task of cleaning bay walls easy
- Works on painted walls, glazed tile, fiberglass, brick and metal

\$76.63 KW5

HAZARDOUS MATERIAL

***** POISONOUS ***
MUST SHIP FREIGHT**



KLEAN WALL II AP FORMULATORS



- 5-Gallons
- 100% HF-Free
- No scrubbing required
- SDS and label have NO poison restrictions
- Made in the U.S.A.

\$76.63 KW-2

HAZARDOUS MATERIAL **California PROPOSITION 65**

MADE IN THE USA

CLEARVIEW DOORS BY GALLOP BRUSH CO.



CLEARVIEW BAY DOORS GALLOP BRUSH CO.



- A high-quality garage and bay door option for car washes, oil change shops, detail shops, and garages. Gallop believes in keeping equipment design simple, but effective, with high quality materials that offer a long lifespan.
- Easy to install and maintain with a durable stainless steel frame and heavy duty Polar Vinyl with a -20 degree cold crack rating.
- Several color options are available and clear sections can be added so you can see in or out of the bay without lifting the door.

SPECIFICATIONS:

- 18" per second 30:1 gear ratio
- 3 Phase 220V motor powered by 110v controller
- 1/2 Horse continuous duty brake motor/inbay system

FEATURES:

- All Corrosion Resistant Stainless Steel
- VFD Control
- Unlimited Duty Cycle
- Tunnel System
- Colors Available
- Polar Vinyl - 20 Degrees Cold Crack Rating
- Wind Load Rating of 70 mph
- External Limit Switch
- 1 Set of Safey Eyes Included
- Corrosion Resistant Components
- 24V Circuitry
- NEMA 4 Rated Enclosure
- ETL Listed
- Door Can Function as a Standalone Unit
- Car Wash Controller Ready
- Controller Has 3 Function Modes - Open, Close & Automatic
- Integrated Delay Timers
- Additional Photo Eyes Available
- Manual Switch Operation Available
- Break Away Design

BENEFITS:

- These doors protect customers and employees from wind, cold temperatures, and inclement weather, keeping them comfortable and safe. If a customer is washing their car in a self-serve bay, they'll stay longer if they're sheltered from unpleasant conditions. For oil change and garage staff, improved conditions mean faster work, fewer breaks, and content employees. Plus, because these doors lock in heat while keeping wind out, you lower your energy consumption costs.
- For car washes, doors block chemicals from spraying wildly and exiting the bay. They prevent wind from pushing water runoff astray, ensuring it flows to the correct drain. In addition, doors that open and close between wash cycles help clearly define the appropriate times for vehicles to enter and exit the bay.



SIZES AVAILABLE	DESCRIPTION/COLOR
10' x 8'	Black, Red, Royal Blue, Green, Gray
10' x 10'	
10' x 12'	
12' x 10'	
12' x 12'	

CHECK OUT OUR NEW LANDING PAGE ONLINE AND REQUEST A QUOTE!



EQUIPMENT



HOT WAX & SHINE SIMONIZ

- Simoniz Hot Wax & Shine is a great new service with attention-grabbing visual appeal! This unique application actually applies carnauba wax to the entire vehicle right inside your car wash tunnel.



WAX APPLICATION



EQUIPMENT SIMONIZ

SIMONIZ EQUIPMENT ARCH - FOR TUNNEL WASH WITH CONVEYOR ONLY

CALL FOR PRICE

SM11000

Includes: Simoniz Bubbler Tunnel Application Arch, Dosatron Pumping Station, Yellow LED Lighting Package, Simoniz Hot Wax & Shine Electric Tunnel Sign, 30 Gallons of Simoniz Hot Wax and Shine, driveway marketing materials. Requires 119" H, 130" W and 28" floor clearance per side pillar.



HOT WAX & SHINE

SIMONIZ HOT WAX TUNNEL SYSTEMS

- Simoniz introduces a new Hot Wax application product for your tunnel and in-bay car wash systems. Now you can actually apply a carnauba wax right in your bays, getting a hand waxed finish with just the push of a button.
- Use 2 - 4 oz per car

\$160.63	PA5338	5-Gal.
\$1,004.90	DR30338	30-Gal.

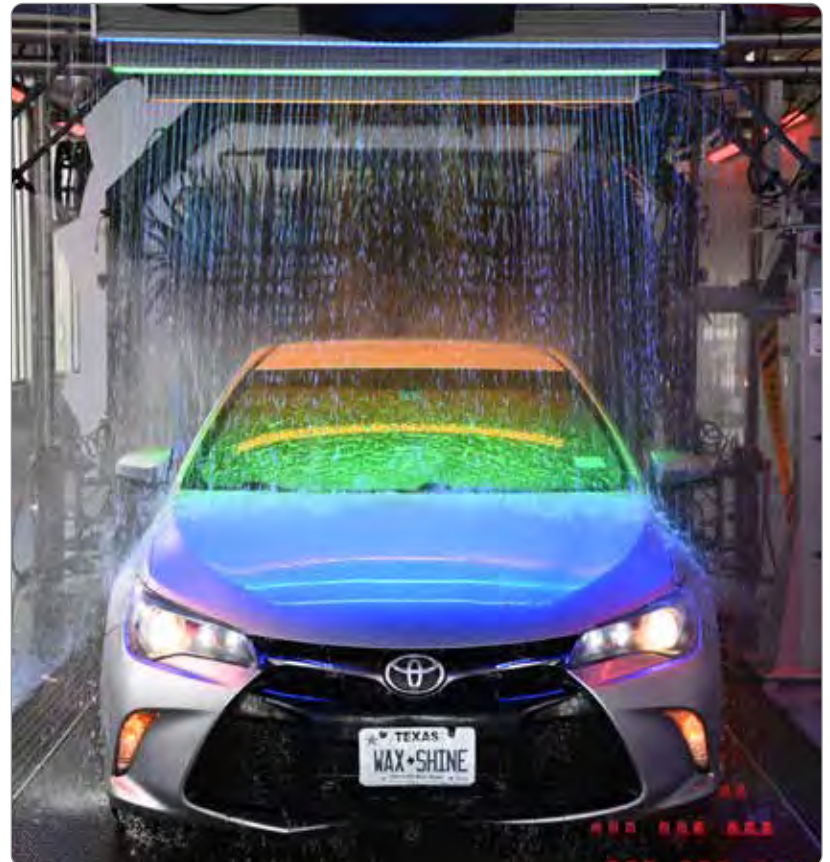

AIR COMPRESSORS



CHAMPION AIR COMPRESSORS EQUIPMENT

CHAMPION

• Loaded with rugged features, splash-lubricated RV Series reciprocating compressors deliver long-lasting performance and tremendous value. Special-alloy steel reed valves provide a self-cleaning design that maintains peak performance throughout the life of the compressor. Cast iron cylinders and heads offer rugged, industrial-rated dependability. Tank mounted units are available in 5 and 7.5 horsepower models, mounted on horizontal or vertical ASME coded air receivers for maximum installation versatility. Larger 10 & 15HP sizes are available upon request.

STANDARD EQUIPMENT:

- Magnetic starters - except 5HP 3600 RPM motor
- Enclosed belt guard
- NEMA-Rated electric motors
- ASME coded receivers
- 0-300 PSIG air-pressure gauge on tank
- Preset pressure switch

AVAILABLE OPTIONS

- Vibration isolators
- Low oil level monitor
- Air cooled aftercoolers

COMPRESSOR PUMP SPECIFICATIONS

- Splash lubricated
- Two-stage design
- Alloy steel reed valves
- Oil level site glass
- Industrial grade intake filter and silencer
- 100% cast iron compressor pump
- Deep finned intercooler
- Factory filled with ChampLub AC Lubricant

PRICE	PART #	MODEL #	STYLE	GAL.	HP	PHASE	PSI	VOLTAGE
CALL FOR PRICE	ACVRV581	VRV5-8	VERTICAL	80	5	1	175	230
	ACVRV583	VRV5-8	VERTICAL	80	5	3	175	230
	ACVRV7F81	VRV7F-8	VERTICAL	80	7.5	1	175	230
	ACVRV7F83	VRV7F-8	VERTICAL	80	7.5	3	175	230
	ACVRV783	VRV7-8	VERTICAL	80	7.5	3	175	230



CHAMP LUB LUBRICANTS & PARTS EQUIPMENT

\$79.61	ACVP80	Vibration Pads
\$16.82	ACCLQT	CHAMP LUB Lubricant - Quarts
\$51.36	ACCLG	CHAMP LUB Lubricant - Gallons

GREASE FITTINGS & DRAIN VALVE



65°
GREASE FITTINGS

\$1.01 GF0265



STRAIGHT
GREASE FITTINGS

\$0.68 GF0200



90°
GREASE FITTINGS

\$1.00 GF0290



ELECTRONIC AUTOMATIC DRAIN VALVE EQUIPMENT

• Removes water from air receivers & piping systems, preventing rusting of tank & damage to tools & controls.

FEATURES:

- 1/4" Inlet & Outlet
- On Time: Adj. 1 - 15 seconds
- Off Time: Adj. 1 - 45 minutes
- 120 with plug 230, 24 Volt AC optional
- LED indicators
- Manual override

FOR AIR COMPRESSORS

- Valve Connections 1/4"
- Max operating press. 300 PSI
- Orifice 7/16"
- 3/8" or 1/2" available

FOR FILTERS

- Valve Connections 1/4"
- Max operating press. 175 PSI
- Orifice 1/8"

\$119.11	ACDRAIN	1/4" Drain Valve	\$95.90	ACFLDR	1/4" Drain Valve For Filter
\$129.24	ACDRAIN-06	3/8" Drain Valve			
\$130.88	ACDRAIN-08	1/2" Drain Valve			

WATER SOFTENERS

CALL FOR PRICING



SHOWN WITH BRINE TANKS

COMMERCIAL WATER SOFTENER SYSTEM

WATER SOFTENERS

REMOVES CALCIUM AND MAGNESIUM SOLIDS.

FEATURES:

- Continuous soft water with alternating twin tank design
- Regeneration based on water use to minimize salt usage and cost associated with operation
- Soft water regeneration for added performance
- Non-corroding polyglass resin tank and high-density polyethylene brine tank
- Dual guard brine operators for prevention of brine tank overflow and accurate brine selection
- Adjustable regeneration cycles for efficient water usage
- High-capacity, long-life cation exchange resin
- Pre-plumbed manifolds reduce field installation expense
- 25 to 125 PSI
 - 100°F maximum temperature
- 24V, 110V, or 220v-50Hz electrical
 - 5-cycle regeneration (backwash, brine draw, slow rinse, fast rinse, & service)



PURE QUALITY RO SYSTEM

PURE QUALITY REVERSE OSMOSIS SYSTEM

REVERSE OSMOSIS SYSTEMS

THE PURE QUALITY REVERSE OSMOSIS SYSTEM FROM GINSAN

FEATURES:

- 600 - 8800 GPD system configurations
- Stainless steel pressure vessels
- Stainless steel multi-stage centrifugal pump
- Permeate flow meter
- Concentrate flow meter
- Digital TDS meter
- Low pressure safety cut off
- Liquid filled pressure gauges
- 20" pre filter
- Simple installation
- High flow, low energy membranes
- Low energy consumption
- Compact system design
- Individually wet-tested and preserved
- Made in U.S.A.

STANDARD

- **MEMBRANE:** 2½" x 40" / 4" x 40" HF4 membrane elements. Focuses on high permeate flow / low energy
- **MEMBRANE HOUSING:** 2½" x 40" / 4" x 40" stainless steel pressure vessels
- **PUMP AND MOTOR:** 1½ or 2 HP Berkley Centrifugal pump and motor (Procon® on 600 & 1200 GPD models)
Units are configured for 208/230 VAC single phase
- **PRESSURE GAUGES:** Shock and UV resistant liquid filled gauges used for superior quality, accuracy and durability
- **INLET SOLENOID VALVE:** Automatically shuts off feed water to the system

CARBON FILTER SOLD SEPARATELY

OPTIONS:

WATER SAVER or AUTO-FLUSH



DELIVERY UNIT

PURE QUALITY REVERSE OSMOSIS SYSTEM UNITS

REVERSE OSMOSIS SYSTEMS

Item #	Description	Compatible filter
RO600	Reverse Osmosis System 600 GPD, Floor Mount	RO6763000
RO1200	Reverse Osmosis System 1200 GPD	RO6763000
RO2200	Reverse Osmosis System 2200 GPD	RO6763000 or RO67631-WL
RO4400	Reverse Osmosis System 4400 GPD	RO67631-WL
RO4400-WSAF	Production RO - 4400 GPD, Floor Mount	RO67631-WL
RO6600	Pure Quality RO 6600 GPD	RO67632-A
RO8800-WSAF	RO Floor Mount System 8800 GDP with Water Saver / Auto Flush	RO67632-A

DELIVERY UNITS

REVERSE OSMOSIS SYSTEMS

GS100732	Floor Mount Delivery Stand 1 Automatic Bay
GS100733	Wall Mount Delivery Stand 1 Automatic Bay
GS100736	Floor Mount Delivery Stand 1-7 SS Bays
GS100737	Wall Mount Delivery Stand 1-8 SS Bays
GS100740	Floor Mount Deliver Stand 1 Auto1-7 SS Bays
GS100741	Wall Mount Deliver Stand 1 Auto1-7 SS Bays

PURE QUALITY CARBON FILTERS

REVERSE OSMOSIS SYSTEMS

RO6763000	Carbon Filter, Automatic Backwashing 1 Cubic Foot, 600/1200/2200 GPD
RO67631-WL	Carbon Filter, Automatic Backwashing, 2.5 Cubic Foot, 2200/4400 GPD
RO67632-A	Carbon Filter, Automatic Backwashing, 3 Cubic Foot, 6600/8800 GPD

WATER SOFTENERS

PRO POWER WATER SOFTENERS

WATER SOFTENERS

- High-quality water is an essential component to any successful carwash operation. Soft water will improve the efficiency and life of your RO equipment, while at the same time reducing overall chemical costs by 10% or more! If you've ever faced challenges with scaling or plugged nozzles due to hardness/scale, then a PRO power Water Softener is just the solution you need!



DFS 1" SERIES TWIN ALTERNATING SOFTENERS

PRO POWER WATER SOFTENERS

- The DFS Series is the most cost-effective way to ensure 24/7 soft water for your car wash. This twin system features a single control valve, ensuring one tank is always on line while the other is regenerating.
- Noryl, electronic, metered control valve includes by-pass assembly with integrated inlet & outlet valves and MPT (PVC) fittings

PART #	RESIN CAPACITY PER TANK/TOTAL	FLOW RATE (CONTINUOUS)
DCS2100	30,000/60,000	13 GPM
DCS2110	60,000/120,000	16 GPM



DRS 1" SERIES

PRO POWER WATER SOFTENERS

- Simple 3-step programming
- High-efficiency metered system with demand initiated regeneration and override function.
- Large LED display
- Includes pre-installed bypass valve
- WQA tested - complies with ANSI/NSF44 performance & 372 lead free compliance.
- **SUPER LOW COST** - Simple set-up & operation!

PART #	RESIN CAPACITY PER TANK/TOTAL	FLOW RATE (CONTINUOUS)
DCS1110	30,000	15 GPM

IDEAL FOR LOWER VOLUME APPLICATIONS



DCS 1½" & 2" SERIES

PRO POWER WATER SOFTENERS

- Sized for softening all water in a car wash!
- Up to 99 GPM continuous & 130 GPM peak flow rates
- Built tough - Epoxy coated lead-free brass valve body & stainless steel flow meter
- Fully programmable regeneration settings
- **OPTIONAL PRE-PLUMBED HEADER AVAILABLE. SEE BELOW**

SIZE	PART #	RESIN CAPACITY PER TANK/TOTAL	FLOW RATE (CONTINUOUS)
1.5"	DCS2020	90,000/180,000	33 GPM
	DCS2025	180,000/360,000	43 GPM
2.0"	DCS2030	120,000/240,000	47 GPM
	DCS2035	210,000/420,000	66 GPM
2.0"	DCS2040	300,000/600,000	73 GPM
	DCS1020	90,000	33 GPM
1.5"	DCS1025	180,000	43 GPM
	DCS1030	120,000	47 GPM
2.0"	DCS1035	210,000	66 GPM

2-TANK METERED TWIN ALTERNATING

1-TANK METERED OR TIME CLOCK SINGLE



DCS 1" & 1¼" SERIES

PRO POWER WATER SOFTENERS

- Ideal for softening chemical/presoak water and feeding RO systems
- Up to 28 GPM continuous & 37 GPM peak flow rates
- Built to last - corrosion resistant noryl control valve body
- Integrated flow meter
- Fully programmable regeneration settings
- Turn-key system - bypass assembly included

SIZE	PART #	RESIN CAPACITY PER TANK/TOTAL	FLOW RATE (CONTINUOUS)
1.25"	DCS2010	75,000/150,000	24 GPM
	DCS2015	120,000/240,000	25 GPM
1.0"	DCS1000	45,000	15 GPM
	DCS1005	90,000	19 GPM
1.25"	DCS1010	75,000	24 GPM
	DCS1015	120,000	25 GPM

2-TANK METERED TWIN ALTERNATING

1-TANK METERED OR TIME CLOCK SINGLE

DCS 1½" & 2" SERIES PRE-PLUMBED HEADERS

PRO POWER WATER SOFTENERS

- Concerned about costly delays and expensive plumber bills during the installation of your twin water softener? Let us take care of it for you with a custom-built pre-plumbed copper header. All you have to do is connect to the common inlet, outlet and drain and you are ready to start it up!
- Pressure-tested to be free of leaks
- Completely turn-key - includes (2) inlet, (1) outlet, and (1) by-pass valves
- Easy access for maintenance - includes 5 unions • PVC (SCH.80) OPTION AVAILABLE!

PART #	DESCRIPTION
DCS6150	Copper Pre-Plumbed Header for 1½" Twin Softener
DCS6200	Copper Pre-Plumbed Header for 2" Twin Softener





BYPASS ASSBLY.



UPPER COLLECTOR

DCF SERIES CARBON FILTERS - AUTO BACKWASHING

PRO POWER

- Auto backwashing, electronic control valve
- Industrial grade carbon media & reinforced media tanks
- Upper collector to prevent media loss during start-up
- By-pass assembly with inlet & outlet valves and PVC fittings (1" or 1½")

SIZE	PART #	RO SYSTEM (RECOMMENDED)	MEDIA (CU. FT.)
1"	DCF6100	1,800 & 2,400 GPD	1.0
	DCF6150	4,800 GPD	1.5
	DCF6200	7,200 GPD	2.0
	DCF6250	9,600 GPD	2.5
1½"	DCF6018	12,000 GPD	5.0
	DCF6021	14,400 GPD	7.5

1" IN & OUT HEAD CARBON FILTERS

PRO POWER

- Lower cost - simple operating
- Includes 1" MPT (PVC) adapters (by-pass only)

1" IN & OUT VALVE

WITH BY-PASS ASSEMBLY

PART NUMBER	MEDIA (CU. FT.)
DCF6020	1
DCF6025	1½



1" IN & OUT VALVE

PART NUMBER	MEDIA (CU. FT.)
DCF6000	1



REJECT CAPTURE SYSTEM

PRO POWER

- Stop throwing your money down the drain! With a Reject Capture System from PRO Power, you can save the reject water from your RO system and deliver it to another carwash application. Depending on your water costs, you can see a complete return on investment in as little as 12-18 months!
- Low limit safety float system (with ¾" brass solenoid & bulkhead assembly)
- 230V, 1-HP pump & pressure tank, control box, power cord L6-20 plug
- Pressure switch (25/45 setting) & pressure gauge
- 100' of ¾" ID reinforced hose

PART #	GPM	PUMP	PRESS. TANK
DCS6500	20	¾ HP	6 Gallon
DCS6510	40	1.0 HP	19 Gallon
DCS6520	60	1½ HP	32 Gallon
DCS6530	90	2.0 HP	50 Gallon



VFD BOOSTER SYSTEMS

PRO POWER

- Do you have issues with inconsistent water pressure and need a complete solution that you can rely on to get the job done? This system is designed to maintain constant pressures for a variety of flow demands. The simplified controls offer fully adjustable pressure from 0-100 PSI to meet most car wash industry needs.
- Pre-plumbed and pre-wired setup so you can focus on your customer
- Small footprint - 26" x 30" all-in-one frame
- Turn-key system, including pressure tank, pressure transducer, relief valve, pressure gauge & shutoff switch

PART #	FLOW	PUMP
DCS7000	70 GPM @ 40 PSI	3 HP
DCS7010	105 GPM @ 40 PSI	5 HP

RO SYSTEMS

PRO POWER

- If you want to amaze your customers with the cleanest vehicle they've ever seen, then a PRO Power Reverse Osmosis System is what you need. Increase profitability by reducing or even eliminating the need for hand drying, without compromising the end result.
- Delivering enough spot-free water for even your busiest days, this turnkey system is built with high-quality components so that you can depend on its performance with minimal maintenance. Let our water treatment experts assess your needs and custom fit the option that is right for you!
- Panel Mounted Pressure Gauges, Flow Meters & RO Controller
- PVC Membrane Housings, and Thin Film Composite
- 5-Micron Pre-Filter (with 1 additional replacement filter)
- Auto Membrane Flush and Adjustable Concentrate Valve
- Corrosion-Resistant, Powder-Coated Steel Frame

STANDARD		
PART #	GPD	CARBON FILTER
DCS3012	800	DCF6100
DCS3015	9,600	DCF6250
DCS3020	12,000	DCF6018
DCS3100	2,400	DCF6100
DCS3110	4,800	DCF6150
DCS3120	7,200	DCF6200

WALL MOUNTED		
PART #	GPD	CARBON FILTER
DCS3002	1,800	DCF6100
DCS3000	2,400	DCF6100
DCS3005	4,800	DCF6150



MEMBRANES & RO SUPPLIES

DOW FILMTEC RO MEMBRANES



- THIN-FILM Composite Membranes for replacement in a wide variety of Reverse Osmosis Systems. FILMTEC Brand. These membranes are designed to be used with tap water. Typical salt rejection is between 96% – 99%. Maximum operation temperature is 113°F. Chlorine pre-filters and water softeners should be used on water supply prior to entering these membranes.



225 PSI MEMBRANES

\$148.65	ROMF150	TW30-2514	14" x 2.4"	200 GPD
\$207.71	ROMF250	TW30-2521	21" x 2.4"	325 GPD
\$283.78	ROMF4021	TW30-4021	21" x 4"	900 GPD
\$281.40	ROMF2200-B-PRO	BW30-4040 (Fiberglass Wrap) For Brackish Water	40" x 4"	2400 GPD
\$281.55	ROMF2200-PRO	TW30-PRO-4040 Brackish water RO < 4" series	40" x 3.9"	2600 GPD

150 PSI MEMBRANES

\$295.50	ROMF2200LE-PRO	LCLC-4040 - 600 PSIG	40" x 4"	2750 GPD
-----------------	-----------------------	----------------------	----------	----------

100 PSI LOW ENERGY (COLD WATER) MEMBRANES

\$204.23	ROMF250LE	XLE-2521	21" x 2.4"	365 GPD
\$249.81	ROMF600LEC	XLE-2540	40" x 2.4"	850 GPD
\$294.52	ROMF4021LEC	XLE-4021	21" x 4"	1025 GPD

HYDRANAUTICS RO MEMBRANES



PRICE	PART #	HYDRANAUTICS #	FILM TEC CROSS REF #	OD X LENGTH	FLOW
\$264.25	RO1000	CPA2-4040	TW30-4040	4" x 40"	2250 GPD
\$272.86	RO1010	CPA5-LD-4040	BW30-4040	4" x 40"	2100 GPD
\$264.50	RO1020	ESPA2-LD-4040	LE-4040	4" x 40"	2000 GPD
\$278.85	RO1030	ESPA4-LD-4040	XLE-4040	4" x 40"	2350 GPD



New!



DOW TAPTEC COMMERCIAL RO MEMBRANES

- Designed to separate salts from water, while delivering precise, consistent, and reliable results!
- Ideal for use in medium to large water treatment systems.
- 113 °F maximum operating temperature (95 °F above pH 10)
- pH range: 2-11 (continuous operation); 1-13 (<30 minutes for cleaning)
- Free chlorine tolerance: < 0.1 ppm

\$232.35	ROMF4040LCHF	3.9" O.D. x 40" L	2800 GPD	125 PSI
-----------------	---------------------	-------------------	----------	---------

KLEEN-RITE RO MEMBRANES



- Kleen-Rite membranes deliver the same quality as name brands but with a reduced cost. Kleen-Rite water membranes offer a permeate flow rate with great applied pressure

\$234.31	KR208333	4" O.D. x 40" L	2500 GPD	100 PSI
\$230.40	KR208396	4" O.D. x 40" L	2200 GPD	225 PSI

ION EXCHANGE RESIN FOR WATER SOFTENING SYSTEMS

RESINTECH WATER FILTRATION



- Removes ionic impurities in small and large purification systems
- Crosslinked gel/strong acid cation resin intended for use in residential and commercial water softening applications
- Supplied in beaded sodium form - offers excellent stability across loss of pressure and change in temperature
- NSF/ANSI-44/61 certified material safety
- Polymer type: Gel
- Ionic form (as shipped): Sodium
- Resin color: Amber
- WQA Gold Seal Certified
- Functional group: sulfonic acid
- Water retention: 46-50% (Na form)
- Weight: 50 lbs.
- Polymer structure: Styrene/DVB
- Physical form: spherical beads
- Screen size dist.: +16 to -50 (US MESH)
- Quantity per container: 1 cu. Ft.

\$175.85	RORESIN
-----------------	----------------

EQUIPMENT

FILTER & MEMBRANE ACCESSORIES



HOUSINGS FOR PREFILTER MEMBRANES

PRICE	PART #	DESCRIPTION	DIAMETER
\$56.32	ROFBBH10	10" Big Blue Filter Housing	4"
\$96.01	ROFBBH20	20" Big Blue Filter Housing	4"



12 X 52 CARBON FILTER FILTERS & MEMBRANES

- Highly effective and efficient at removing organic contaminants and chlorine to protect RO membranes
- Relatively inexpensive with no recurring cost of consumable chemicals
- Easily cleaned and maintained
- Resistant to fouling (clogging)
- Filtration media is inexpensive and long-lasting
- Control valves are modular and designed for operational flexibility

\$921.27 DCF6200



STAINLESS STEEL HOUSINGS FOR RO MEMBRANES

\$278.22	ROMFH2540	Fits 2.5 x 40 membrane
\$373.80	ROMH40	Fits 4 x 40 membrane
\$340.50	ROMH40-U	4 x 40 - U Pin Style



WRENCH BIG BLUE HOUSING FILTERS & MEMBRANES

\$3.75	R09205	H-C9205 For AMI 10" & 20" Big Blue Housings
\$2.89	R09200	H-C9200BK for Standard 10" Filter Housings
\$9.58	R09203	H-C9203 For Standard 20" Filter Housings

SEDIMENT FILTERS FOR RO MEMBRANES

20" 5 MICRON
5½" DIA.

ROFCP5BB



10" 5 MICRON
2½" DIA.

ROF1005



10" 5 MICRON
PRE FILTER 2½" DIA.

ROFCP5



BIG BLUE 10" 5
MICRON 4" DIA.

ROFBB1005



10" X 2½" CARBON
IMPREGNATED FILTER

ROFC10



PRICE	PART #	DESCRIPTION	DIA.
\$12.28	ROFBB1005	Big Blue 10" 5 Micron RO Sediment Filter (ROFBB1005CS CASE)	4½"
\$19.42	ROFBB2001	Big Blue Filter 20" 1 Micron	4½"
\$15.74	ROFBB2005	Big Blue Filter 20", 5 Micron (ROFBB2005CS: 6 per case)	4½"
\$55.23	ROFBB2030	Big Blue Filter 20" 30 Micron	4½"
\$45.62	ROCFBB20	Big Blue Carbon Filter 20"	4"
\$41.16	ROFC155428	Big Blue Impregnated Filter 20" 5 Micron	4½"
\$15.08	ROFC10	9¾" x 2½" Carbon Impregnated Filter	2½"
\$35.25	ROFC20	20" x 2½" Carbon Impregnated Filter	2½"
\$323.89	ROM4040AHF	40" Osmonics Style RO Membrane - 2800 GPD	4"
\$462.78	ROMB4040	40" Osmonics Style RO Membrane - 2200 GPD	4"

PRICE	PART #	DESCRIPTION	DIA.
\$3.77	ROF1001	1 Micron Sediment Filter 10"	2½"
\$4.43	ROF2001	1 Micron Sediment Filter 20"	2½"
\$17.60	ROFCP5	10" 5 Micron Pre Filter	2½"
\$13.37	ROFCP520	20" 5 Micron Pre Filter	2½"
\$35.54	ROFCP520BB	20" 5 Micron Pre Filter	4½"
\$4.72	ROF2005	20" 5 Micron RO Sediment Filter (ROF2005CS CASE)	2½"
\$306.67	ROMA4040HF	40" High-Flow RO Membrane - 2800 GPD	4"
\$2.33	ROF1005	5 Micron SDF for RO Systems	2½"
\$3.88	ROF1005STR	5 Micron String Filter	2½"
\$13.11	ROF2005STR	5 Micron String Filter	-

ACCESSORIES FOR RO MEMBRANES

LLS100



ROMHEC



ROF5100



PRICE	PART #	DESCRIPTION
\$89.79	ROMHEC	PVC End Cap for Housing (with O-Rings)
\$96.21	ROMHEC40PD1	4" PVC End Cap for Housing (with O-Rings)
\$32.97	ROMH25GWD	2.5" Dual Port End Cap (with O-Ring)
\$35.76	ROMH25GWS	2.5" Single Port End Cap (with O-Ring)
\$13.74	LLS300	Liquid Level Switch, Poly Float, Vertical Mount
\$17.03	LLS100	Liquid Level Switch, Poly Float, Horizontal Mount
\$8.25	ROORING10	O-Ring Seal Plug U4 PV
\$9.73	ROORING20	Internal O-Ring for 2.5" & 4" End Caps
\$16.40	ROORING30	O-Ring for ROFBH10

PRICE	PART #	DESCRIPTION
\$114.65	ROCARBON	Activated Charcoal
\$31.80	ROF5100	RO Storage Float Switch
\$93.54	ROGRAVEL	#100 Fine Gravel (50 lb. bag)
\$8.01	ROFHB2010W	Single Bracket for ROFH20
\$17.10	ROFHB2039W	Mounting Bracket for ROFBH10 & 20
CALL	RO2580	2.5" Black Membrane Seal
\$27.25	ROCL40W	End Clamps for 4" Stainless Steel Membrane Housing
\$13.07	ROYCUP418	Uni-Strut Clamp
\$327.05	ROMH40PVC	4" x 40" PVC Pressure Vessel
\$57.22	ROCC2520A11	Cleaning Kit

WATER HEATERS



9,000 - 199,000 BTU

INFINITI® K SERIES TANKLESS (CONDENSING) GAS WATER HEATER INDOOR MODEL BRADFORD WHITE WATER HEATERS

- **ENERGY STAR® QUALIFIED** - Meet or exceed requirements for ENERGY STAR® per the latest ENERGY STAR® criteria revision, as well as most utility rebate programs
- **FEATURING THE SRT™ SCALE REDUCTION TECHNOLOGY** - Significantly reduces the incidence of scale build-up known to result in poor performance, additional maintenance, and pre-mature component or product failure
- **STEADYSET™ TECHNOLOGY** - Virtually eliminates cold water sandwich without the need for an internal buffer tank and recirculation pump
- **BUILT-IN DIGITAL CONTROL** - Temperature can be adjusted on the front control panel (100-140°F) (38°C-60°C).
- **ACTIVE BYPASS** - Achieves superior temperature stability (±2°F) (±1°C)
- Modulation-Segmented burner with 22:1 turn down ratio
- **SELF-CALIBRATING FAN AND GAS VALVE** - Simple combustion management system uses self-calibrating sensors to automatically configure air fuel ratio for flue length, gas type, and altitude - without a combustion analyzer
- **EXTERNAL RECIRCULATION PUMP WIRING-INSTALLED** - Built-in controls provide precise operation of external recirculation pump with, or without, additional external temperature sensor (Recirculation pump sold separately)
- **VENTING FLEXIBILITY**
- **GAS CONNECTION FLEXIBILITY** - 1/2", 3/4", or 1" connections permitted
- **TOP WATER CONNECTIONS** - For easy retrofit
- **INLET WATER FILTER** - External access for easy maintenance
- **SPACE SAVING INSTALLATION** - Compact size for tight installations
- **BUILT-IN FREEZE PROTECTION** - Protects unit from freezing. Activates automatically when the water heater is plugged in
- **PRESSURE RELIEF VALVE** - Included (Integral port)
- **BUILT IN FLUSH VALVES** - For servicing/de-scaling
- **FLUSHING CONDENSATE TRAP**
- **COMPLIES WITH THE LATEST ULTRA-LOW NOX REQUIREMENT (10 NG/J NOX LIMIT)**
- **EASY LP GAS FIELD CONVERTIBILITY** - Purchase of additional kit NOT required to convert from NG to LP

PRICE	KR #	MFG #
\$1,554.11	BH0100	RTG-K-199-N1

TANKLESS WATER HEATER VALVE KIT

WATER HEATER ACCESSORIES

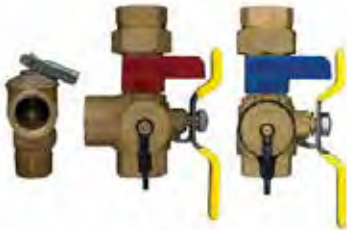

- Easily install separate hot and cold isolation valves and a pressure relief valve to your existing tankless water heater. Adds more safety features and benefits to your system with ease! This kit provides full port testing and flushing of the system with union connections to ensure a fully secure and safe installation!
- 2-step color-coded union connections
- Full port throughout entire valve body
- Brass construction
- Connection: 3/4" NPT
- Quarter turn ball valve operation
- Flushing and descaling capability
- Pressure: 150 PSI
- Pipe Size: 3/4"

CALL	BHP4000
-------------	----------------

BAYWATCH HEATERS



BAYHEAT ALL STAINLESS STEEL RADIANT HEATERS

BAYWATCH CAR WASH DOOR SOLUTIONS

PART #	PRODUCT	DESCRIPTION/FEATURES
R-125-40	BAYHEAT VCS-125	40' Tube package, 125,000 BTU with gas shut-off cock and flex line
R-150-50	BAYHEAT VCS-150	50' Tube package, 150,000 BTU with gas shut-off cock and flex line



BAYHEAT ELECTRIC HEATERS

BAYWATCH CAR WASH DOOR SOLUTIONS

PART #	PRODUCT	DESCRIPTION/FEATURES
BH-E-10KW	BAYHEAT EWHB 10 kW	Stainless steel electric unit heater for high moisture environments. 34,000 BTU. Wall Bracket. 24V Controls
R-100-30	BAYHEAT EWHB 15 kW	Stainless steel electric unit heater for high moisture environments. 52,000 BTU. Wall Bracket. 24V Controls
R-125-40	BAYHEAT EGW-5 kW	Electric unit heater. Wall or ceiling mount. For equipment room heating



BAYHEAT ACCESSORIES

BAYWATCH CAR WASH DOOR SOLUTIONS

PART #	PRODUCT	DESCRIPTION/FEATURES
HR-003-00	I-RTVP-4-I-F ROOFTOP EXHAUST PKG	Rooftop exhaust package. Flat 4" with tall cone flat flashing. 4" B-Vent, storm collar, 4" 90° adjustable B-Type elbow, B-Type to single wall reducer and low profile intel top
HR-003-01	RTVP-4-I-A ROOFTOP VENT KIT ADJUSTABLE	Rooftop vent kit. Adjustable 4" with low wind vent top storm collar, 5' single wall 4" pipe, adjustable 90° elbow, appliance connector and adjustable roof flashing.

HEATING FIXTURES

HIGH-EFFICIENCY GAS FIRED COMMERCIAL SPACE HEATERS

REZNOR

This gas-fired heating unit is housed in an attractive gloss white cabinet and is power vented to avoid heat losses up the flue pipe and save you money over time. UDAP space heaters boast 82-83% thermal efficiency, which means they meet most thresholds for utility company rebates.

SPECIFICATIONS & KEY FEATURES

- 82-83% thermal efficiency - TOP IN ITS CLASS!
- 50-60° F rise range
- Tcore2 titanium stabilized aluminized steel heat exchanger
- Patented single burner combustion system including a one-piece burner assembly
- 115/1/60 Supply voltage
- 115V open fan motor with internal overload protection
- Transformer for 24-volt controls
- Integrated circuit board with diagnostic indicator lights
- Multi-try direct spark ignition with timed lockout
- Fan relay (included on the circuit board)
- Single-stage natural gas valve (field adjustable for operation to 9,000 ft. elevation)
- Vibration/noise isolated fan and venter motors - designed for low noise operation
- 2-pt and 4-pt Suspension - standard on all sizes
- External terminal strip for 24V wiring
- External gas connection
- Full fan guard - engineered for safety
- Improved cabinet design with less visible hardware

\$1,065.35	UDX-45	45,000 BTU
\$1,247.71	UDX-75	75,000 BTU
\$1,515.04	UDX-125	120,000 BTU



BOILERS

TRINITY LX

BOILERS



- **91+% EFFICIENT, WALL HUNG, CONDENSING GAS, BOILER FOR NATURAL GAS OR PROPANE!**
- NTI's combustion system produces the highest industry modulation rates, which allows the Trinity to modulate the burner to the exact size required to meet the conditions of the system. The Trinity incorporates an electronic state-of-the-art combustion system to reduce the amount of gas that is injected into the burner, to ensure proper combustion throughout the full range of modulation. This system also compensates for extended venting; therefore, adjustments are not required between short and long vent runs. The Trinity is a totally sealed combustion system: all combustion air is drawn from outside, used for combustion and then expelled.

SPECIFICATIONS	LX300	LX400
SIZE (D X W X L)	36" x 17" x 21"	23.5" x 21" x 36"
WEIGHT	125 lbs	205 lbs
MAX. PRESSURE	160 PSI	145 PSI
MAX. VENT	4'/6" - 100'	4"-30', 6"-65' eqv.
GAS CONNECTION SIZE	1/2"	3/4" NPT
BTU INPUT	55,000 - 275,000	75,000 - 399,000
BTU OUTPUT	52,000 - 251,000	69,000 - 365,000
S.S. EFFICIENCY	93%	96%
HEAD LOSS @ GPM	7' @ 14	9' @ 20
SUPPLY/RETURN	1 1/4" NPT	1 1/4" NPT
BOILER MODULATION RATIO	5:1	5.3:1
PRICE	\$8,003.07	CALL



WHEN PURCHASING A TRINITY BOILER, YOU MUST PURCHASE A TACO® CARTRIDGE CIRCULATOR

0011 CARTRIDGE CIRCULATOR

TACO® SYSTEMS

- The High Velocity series Taco 0011 Cartridge circulator is designed for high head/medium flow applications in residential or light commercial hydronic heating, radiant heating, and chilled water cooling systems. The unique ACB anti-condensate baffle with ambient air flow prevents the build up of condensate on the motor windings when pumping chilled water. Its unique field-serviceable cartridge contains all moving parts. Replacing the cartridge rebuilds the circulator. With no mechanical seal, the self-lubricating, maintenance-free design provides unmatched reliability. Compact and lightweight, with excellent performance characteristics, the 0011 is ideal for installations where space is a premium.

- **FLOW RANGE:** 0 - 31 GPM
- **HEAD RANGE:** 0 - 31'
- **MIN. FLUID TEMPERATURE:** 40°F (4°C)
- **MAX. FLUID TEMPERATURE:** 230°F (110°C)
- **MAX. WORKING PRESSURE:** 125 PSI
- **CONNECTION SIZES:** 3/4", 1", 1 1/4", 1 1/2" Flanged

\$458.33 TACO4000



PORTABLE HEATERS



**DIESEL #1 OR #2
KEROSENE**



**DIESEL #1 OR #2
KEROSENE**

EC SERIES INDIRECT-FIRED PORTABLE HEATERS

PORTABLE HEATERS

- Overheating thermostat (safety device turns off unit and requires a manual reset)
- AISI 430 stainless steel combustion chamber with four-pass heat exchanger technology (EC 200-EC300)
- Single Fuel Line Kit: This accessory allows the unit to recirculate hot oil from the return line back into the filter. The hot oil in the filter eases restarts and increases the performance of the unit in extreme cold temperature
- Combustion air pressure switch (safety device turns off unit and requires a manual reset)
- No supervision required can be controlled by thermostat, humidistat or timer
- Automatic post ventilation cycle to cool down the combustion chamber
- Fuel lines in hydrocarbon-resistant rubber wire-mesh protected
- Oil filter; pre-heated oil filter (EC200-EC300)
- Approved for construction
- 1' power cord
- Bayonet-type fuel tank cap
- Fuel tank drain plug
- Electric control panel (see page 4)
- Electronic flame control unit
- 10" pneumatic wheels

INFO	EC 100	EC 200	EC 300
HEAT INPUT BTU/H	112,141	204,873	293,982
HEAT OUTPUT BTU/H	94,759	183,362	258,704
FUEL CONSUMPTION US GAL/H	0.81	1.48	2.17
HEATED AIRFLOW CFM	1,020	1,530	2,530
TEMPERATURE RISE (@64°F)	95°F	136°F	126°F
POWER SUPPLY V, PH, HZ	120, 1, 60	120, 1, 60	120, 1, 60
FAN MOTOR POWER HP (RPM)	1/4 (3,300)	5/8 (3,300)	1 (1,700)
CURRENT RATING AMPS	4.05	7.65	11.80
MAX LENGTH FLEX. DUCT (1-WAY)	25 FT	50 FT	75 FT
MAX LENGTH FLEX. DUCT (2-WAY)	--	25 FT	35 FT
FLUE SIZE	6"	6"	6"
TANK CAPACITY	11 Gal	17.2 Gal	27.7 Gal
RUN TIME	14 Hours	14 Hours	13 Hours

HEATERS		
\$2,452.38	HTR487002	EC 100 - 100,000 BTU
\$3,525.30	HTR487003	EC 200 - 200,000 BTU
\$4,291.67	HTR487004	EC 300 - 300,000 BTU
HEATER ACCESSORIES		
\$70.69	HTR487105	Fuel Level Gauge
\$22.04	HTR487106	Fuel Tank Filler
\$59.68	HTR487107	Lifting Bracket
\$140.40	HTR487109	One Way Duct Adapter - 12" (EC 100)
\$179.76	HTR487110	One Way Duct Adapter - 14" (EC 200)
\$330.68	HTR487112	Two Way Duct Adapter (EC 200)
\$408.12	HTR487113	Two Way Duct Adapter (EC 300)
\$314.65	HTR487115	External Fuel Tank Connect Kit
\$370.43	HTR487116	External Fuel Tank Kit w/ Deaerator



FIRE 155 INFRARED PORTABLE HEATER

PORTABLE HEATERS

- Metallic forced air insulation pocket between the combustion chamber and the external protection cone
- Single Fuel Line Kit: This accessory allows the unit to recirculate hot oil from the return line back into the filter. The hot oil in the filter eases restarts and increases the performance of the unit in extreme cold temperature
- Combustion air pressure switch (safety device turns off unit and requires manual reset)
- No supervision required: controlled by thermostat, humidistat or timer
- Automatic post-ventilation cycle to cool down the combustion chamber
- Possibility of directing the cone up and down with locking mechanism
- Fuel lines in hydrocarbon-resistant rubber wire-mesh protected
- Direct heat flow by radiation with no air movement
- Oil filter included (optional pre-heated oil filter)
- Built-in oil burner with Danfoss gear pump
- Electronic flame control unit with metal casing
- AISI 430 stainless steel combustion chamber
- Low noise level
- Screw-on fuel cap
- Fuel tank drain plug
- 12" reinforced plastic wheels
- Approved for construction
- 1' power cord
- Shockproof polyethylene fuel tank
- Single point lift bail
- 17.2 Gal
- Floor protection sliding shield

MAX POWER 2ND STAGE	154,237 BTU
FUEL CONSUMPTION 2ND STAGE - 1ST STAGE	1.11 GPH
POWER SUPPLY	120V, 1PH, 60HZ
FAN MOTOR POWER	1/2HP, 3,300 RPM
TANK CAPACITY	17.2 Gal
RUN TIME 2ND STAGE - 1ST STAGE	16 Hours

\$3,218.75 **HTR487001** 155,000 BTU

HEATER ACCESSORIES		
\$137.08	HTR487101	Heavy Duty Thermostat w/ 30' Cable
\$70.69	HTR487102	Fuel Level Gauge
\$243.18	HTR487103	Pre Heated Oil Filter
\$45.70	HTR487104	Single Fuel Line Kit



PORTABLE HEATERS



FLAME 115 INFRARED PORTABLE HEATER

PORTABLE HEATERS

- The innovation of the Flame115 Infrared Heater lies in the elimination of the refractory material cone that surrounds the conical combustion chamber that's typical of other competitors units. Our heater features a metallic forced air insulation pocket between the combustion chamber and the external protection cone. The cooling air is blown through the pocket by the burner fan. This innovative technology over comes the well-known problem of the fragility and brittleness of the ceramic cone.
- Electronic flame control unit with metal casing
- Approved for construction & agriculture
- Automatic post-ventilation cooling cycle
- Directional cone locking mechanism
- Built-in oil burner with gear pump
- Shockproof polyethylene fuel tank
- Extendable sliding floor shield
- Patented triple cone design
- CSA approved
- Low noise level
- Screw-on fuel gauge
- AISI 309 L stainless steel cone
- Fuel tank drain plug
- Only 92 lbs.
- Remote thermostat plug
- 8" reinforced plastic wheels

MAX POWER 2ND STAGE	115,160 BTU/H
FUEL CONSUMPTION 2ND STAGE	0.85 US GAL/H
POWER SUPPLY	120,1,60 V, PH, HZ
FAN MOTOR POWER	1/4 (3,300) HP (RPM)
TANK CAPACITY	11.35 US GAL
RUN TIME 2ND STAGE	13.4 HOUR

CALL	HTR487019	115,000 BTU	
-------------	------------------	-------------	--

HEATING ACCESSORIES



FLOOR HEAT ANTI-FREEZE

HEATING

- Keep your bay floors from freezing in cold climates or winter conditions. Frozen floors pose a safety risk to customers and employees at your wash. Make sure your wash is in good supply of anti-freeze with this 5 gallon pail!
- Freeze protection to -60 degrees Fahrenheit
- Non-toxic
- Cryo-Tek brand, manufactured by Hercules
- Corrosion-resistant

\$216.03	FHAF5
-----------------	--------------

PROPANE TANKS

HEATING

\$39.00	PST20	20lb Tank	\$815.00	PST120VT	120 Gallon Vertical Tank
\$115.00	PST30	30lb Tank	\$2,575.00	PST500AG*	500 Gallon - Above Ground
\$120.00	PST40	40lb Tank	\$2,985.00	PST500UG*	500 Gallon - Below Ground
\$250.00	PST100	100lb Tank	\$4,275.00	PST1000AG*	1000 Gal - Above Ground
\$285.00	PSTATM	Aluminum Tow Motor Tank	\$4,595.00	PST1000UG*	1000 Gal - Below Ground

PROPANE TANK PARTS & ACCESSORIES

HEATING

\$21.00	PST8805	40" Copper Pigtail - U-Shaped	\$25.00	PST8800	Propane T-Block
\$12.00	PST8810	20" Copper Straight Pigtail	\$250.00	PSTANODE	Anode Bag for Underground Tank

***500 & 1000 GALLON TANKS ARE AVAILABLE AS PICK-UP-ONLY ITEMS. NOT AVAILABLE FOR PICKUP AT OUR KANSAS CITY WAREHOUSE**



VACUUM PIT CLEANERS



RING-O-MATIC 750 VAC VACUUM PIT CLEANERS

- An electric start 11HP Honda engine and a 160 CFM (cubic feet per minute) vacuum/blower capable of 25 inHg of vacuum. This unit has a 650 gallon collection tank capacity (9,990 lbs fully loaded weight).
- A good solution for operators who have pits deeper than 7'6". The 750 vac pit cleaner operates efficiently at depths up to 10'. See our 750 Deep Vac for cleaning pits up to 15' deep - great for car washes with limited access pits!
- 750 vac can empty a typical 100 cubic foot sediment pit in about 40 minutes
- Easy to use and to unload. The tank is dumped using a hydraulic lift system. The mud load is set free from inside the tank by using a pneumatic load breaker. Both the pneumatic load breaker and the hydraulic system are driven by the pit cleaner's engine with simple, easy-to-use controls.
- The 750 vac weighs in at 9,990 lbs fully loaded. This means it can be safely and legally pulled by a full size pick-up. Check your vehicle to see if it is rated to safely handle this conveniently sized unit.

SPECIFICATIONS:

- **TANK CAPACITY:** 85 cu ft, 650 gal., 3.2 cu yd
- **EMPTY WEIGHT:** 3120 lbs
- **OVERALL TRAILER:** 75" W x 15' L x 7' H
- **HEIGHT IN TRANSPORT:** 7'
- **MAX DIG DEPTH:** 10' below ground level
- **ENGINE:** Electric Start 11 HP Honda
- **MAX HEIGHT:** 7' in operation

INCLUDES:

- 2 5/16" ball hitch
- Jack
- 235/80/R16 tires

CALL PITPUMP750V

RING-O-MATIC 850 DEEP VAC VACUUM PIT CLEANERS

- Engine - electric start OHV air cooled 21 HP
- 230 CFM (cubic feet per minute) vacuum/blower capable of 25 inHg of vacuum
- The 850 Deep Vac is an ideal pit cleaner for operators who have car washes with limited access pits. These pits are often the secondary pits where cleaning access is available through a manhole or other small opening.
- Easy to use and to unload. The tank is dumped using a hydraulic lift system. Mud-cake is set free from the bottom of the collection tank using a pneumatic load breaker. The pneumatic load breaker and the hydraulic system are driven by the pit cleaner's engine with simple, easy-to-use controls. The 850 Deep Vac can also be unloaded with its pressurized off-load feature.
- Weighs in at 12,800 lbs fully loaded. This means it can be safely and legally pulled by a full size pick-up. Check your vehicle to see if it is rated to safely handle this conveniently sized unit.

SPECIFICATIONS:

- **TANK CAPACITY:** 107 cu ft, 800 gal., 3.9 cu yd
- **EMPTY WEIGHT:** 3600 lbs
- **OVERALL TRAILER:** 75" W x 20' L x 7' H
- **HEIGHT IN TRANSPORT:** 7'
- **MAX DIG DEPTH:** 15' below ground level
- **ENGINE:** Electric Start 11 HP Honda
- **MAX HEIGHT:** 7' in operation

INCLUDES:

- 2 5/16" ball hitch
- Jack
- 235/80/R16 tires

CALL PITPUMP850DV

EXCAVATOR PIT CLEANERS

RING-O-MATIC 500T EXCAVATOR PIT CLEANERS

SPECIFICATIONS:

- **MUD BOX CAPACITY:** 41 cu ft, 330 gallon, 1.5 cu yd
- **MAX DIG DEPTH:** 5' below ground level*
- **BUCKET SIZE:** 12" W x 20" L, 1ft³ capacity
- **BOX DIMENSIONS:** 44" W x 96" L x 17"H
- **ENGINE:** 6.5 HP Honda
- **OVERALL TRAILER LENGTH:** 15'5"
- **EMPTY WEIGHT:** 1500 lbs
- **LOADED WEIGHT:** 7100 lbs
- **HEIGHT IN TRANSPORT:** 7'2"

INCLUDES:

- 2 5/16" ball hitch
- Jack
- 235/80/R16 tired

CALL PITPUMP500T

UPGRADE BOOM ALLOWS 7'6" DEPTH

RING-O-MATIC 1000H EXCAVATOR PIT CLEANERS

SPECIFICATIONS:

- **MUD BOX CAPACITY:** 67.5 cu ft, 505 gallon, 2.5 cu yd
- **MAX DIG DEPTH:** 8' 4" below ground level
- **BUCKET SIZE:** 12" W x 20" L, 1ft³ capacity
- **BOX DIMENSIONS:** 44" W x 96" L x 29" H
- **ENGINE:** 8 HP Honda
- **OVERALL TRAILER LENGTH:** 16'3"
- **EMPTY WEIGHT:** 2200 lbs
- **LOADED WEIGHT:** 10,000 lbs
- **HEIGHT IN TRANSPORT:** 7' 5"

INCLUDES:

- 2 5/16" ball hitch
- Jack
- 235/80/R16 tired

CALL PITPUMP1000H



EQUIPMENT

PIT ENZYMES, DEODORIZERS & GRATING



PIT ENZYME AP FORMULATORS



- Used in reclaim systems as an odor/oil remover. Enzymes eat oil and odor causing bacteria
- 5 gallons | RTU - no dilution necessary
- Fresh & Clean fragrance

\$112.45 **APF5520**



PIT DEODORIZER NATIONAL AUTOMOTIVE CHEMICAL



- Remove the odor in both self-serve pits and reclaim systems - keeps bays smelling fresh
- Cinnamon scented

PRICE	PART #	GALLONS	DILUTION
CALL	NAP5406	5	240-500:1
	NAD55406	55	



KLEEN-RITE EZ-GRATE

EZ-GRATE FIBERGLASS CAR WASH GRATING

KLEEN-RITE

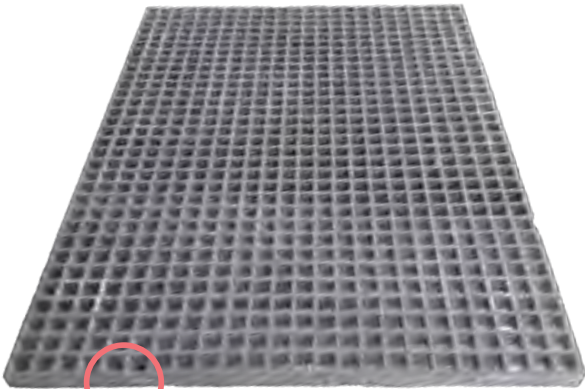

- Kleen-Rite EZ-Grate is a tough fiberglass grating option for car wash pits and industrial drain areas. Made with durable polyester resin with a gritty no-slip grip. The reduced size of EZ-Grate allows it to be moved and lifted much easier, has a smaller footprint for shipping, allows for easier shape customization without cutting, and lets you replace small sections of grating if damage occurs rather than huge sections.
- Gray or yellow color option
- 1 1/4" squares, 1 1/2" thickness
- Gritty non-slip top
- Easier moving and lifting
- Smaller shipping footprint
- Shape customization with less cutting
- 4' x 4' or 3' x 4' pieces
- Super-tough polyester resin fiberglass construction
- Reduced size versus traditional grating
- Non-metal material means no theft for scrapping
- Corrosion-resistant for wet, harsh environments
- Ability to replace smaller sections

GRAY GRATING		
\$127.00	FG34G-GRIT	3' x 4' Panel
\$139.00	FG44G-GRIT	4' x 4' Panel

YELLOW GRATING		
\$127.00	FG34Y-GRIT	3' x 4' Panel
\$139.00	FG44Y-GRIT	4' x 4' Panel

LOAD	SUPPORT/ CLEAR SPAN (IN)	UNIFORM LOAD (LBF/FT ²)					AVG. MAX LOAD
		100	200	300	400	500	
		AVG. MIDSPAN DEFLECTION (IN)					
Uniform	18	0.18	0.21	0.24	0.26	0.29	1042

LOAD	SUPPORT/ CLEAR SPAN (IN)	CONCENTRATED LOAD (LBF)						AVG. MAX LOAD
		100	200	300	400	500	1000	
		AVG. MIDSPAN DEFLECTION (IN)						
Concentrated	18	0.012	0.020	0.027	0.033	0.039	0.067	10307

GRATE ACCESSORIES

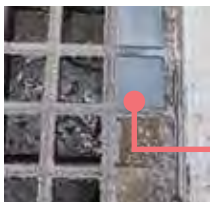

MUD STOPPER FIBERGLASS GRATE PLUGS

VACUUM PROSPECTOR

Have you noticed that mud, grime, and grit sometimes builds up in the outer holes of the fiberglass grating in your car wash bay? It's difficult to clean out this sludge and it might begin to collect gravel and small pieces of trash. This is unattractive and potentially unsafe for customers. In addition, this increases the possibility that brushes will pick up solid particles that can scratch or damage vehicle surfaces. Mud Stopper plugs easily and quickly solve this problem! Once you identify which holes in your grating collect mud, you can clean them out and insert a plug in each one. This directs the mud and sludge further towards the center of the grate where it will fall into the pit instead of collecting.

- 100 plugs included
- Use with fiberglass car wash grating
- Fits 1 1/4" square grate holes
- Easy install - use a mallet or hammer!

\$39.00 **MS32**

OPERATOR PRO



OPERATOR PRO VFD DIRECT DRIVE PUMP STAND

KLEEN-RITE CORP.

KLEEN-RITE CORP.

• The Operator Pro is a fully-built compact pump stand for six bays. The Operator Pro package reduces the amount of equipment needed to operate the standard car wash functions commonly offered in a car wash bay. Includes trusted CAT Pumps and Baldor motors. Hoses, fittings, regulators, electrical parts, and other components are included and it's basically a plug-and-play unit. Designed to service six bays, and you can choose what functions you need.

PUMP SPECIFICATIONS:

- **MAX FLOW:** 4 GPM
- **MIN. PRESSURE:** 100 PSI
- **MAX PRESSURE:** 2500 PSI
- **INLET SIZE:** 1/2" NPT
- **DISCHARGE SIZE:** 3/8" NPT
- **MAX. SPEED:** 1725 RPM
- **MATERIAL:** Brass

MOTOR SPECIFICATIONS:

- Catalog Number: CEM3615T
- Enclosure: TEFC
- Frame Material: Steel
- Output @ Frequency: 5 HP @ 60 HZ
- Agency Approvals: UR, CSA EEV, CSA
- Ambient Temperature: 104 ° F
- Base Indicator: Rigid
- Drip Cover: No Drip Cover
- Duty Rating: Continuous
- Efficiency @ 100% Load: 89.5%
- Synchronous Speed @ Frequency: 1800 RPM @ 60 HZ
- Voltage @ Frequency: 460 V @ 60 HZ, 230 V @ 60 HZ
- Current @ Voltage: 13.4A @ 230V, 13.9A @ 208V, 6.7A @ 460V

CALL	PS200/PS6A138-2-A *	2 Bay
	PS300/PS6A138-3-A *	3 Bay
	PS400/PS6A138-4-A *	4 Bay (shown)
	PS500/PS6A138-5-A *	5 Bay
	PS600/PS6A138-6-A *	6 Bay

*** FREIGHT ONLY**



Add on a monitoring sensor to your pump stand.

Check your systems in real-time to increase efficiencies and check for malfunctions.

\$399.00 **PSA** Sensor Dynamics monitoring sensor

Monthly fee required. Register at SensorDynamix.com/Registration/Kleen-Rite when placing order.

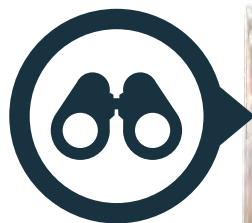

CHECK IT OUT! INSIDE THE CABINET AREA

- 71" H x 58" W x 32" D
- You can power all the functions in your bays - low, medium, and high-pressure - with less equipment because it uses variable-frequency drives (VFDs)
- Efficiency @ 100% Load: 89.5%



MAT CLEANERS



RUG BEATER

DRALCO MAT CLEANERS



USE FOR CLEANING THE FOLLOWING OFF OF FLOOR MATS:

- Sand
- Ice
- Ground in dirt
- Grass
- Dirt
- Snow
- Dog hair
- Food stains (with stain remover)

RUG BEATER FEATURES:

- Stainless steel
- Direct-drive motor
- Cleans mats up to 34"
- Pressure plate automatically adjusts to mat thickness
- 110V, 120V power supply
- Fully tested before shipped
- No water/sewer needed

\$5,479.27	RB200	Full Service
\$6,942.68	RB300	Coin Operated



MATWACKER

DRALCO MAT CLEANERS



MATWACKER FEATURES:

- Cleans mats up to 30" wide
- Patented skip-brush technology
- (2) Greasable bearings
- Indoor/Outdoor service
- 110VAC Standard Power
- Galvalume steel construction
- 1/2 HP Single Phase motor
- Shutoff & Adjustable Timer

AVAILABLE OPTIONS:

- Urethane Wheels/Locking
- Spray bottle holder
- Extended warranty

MATWACKER DIMENSIONS & WEIGHT:

- Length: 40"
- Height: 35 3/4"
- Depth: 18 3/4"
- Weight: 225 lbs.

\$4,434.46	MW110
-------------------	--------------



MAT-VAC® WITH CENTRAL VAC EXTENSION

J-KO U.S.A.



- 50" H x 45" W x 21" D
- Weight: 230 lbs.
- Power: 110V (20 AMPS)
- Speed: Vacuums mat in 5 seconds
- Connects directly to central vac system. Suction valve open only when machine is in use.
- All stainless steel

CALL	JKMV-CV
-------------	----------------

MAT-VAC® WITH VAC MOTOR & TANK

J-KO U.S.A.



- 50" H x 45" W x 21" D
- Weight: 255 lbs.
- Power: 110V (20 AMPS)
- Speed: Vacuums mat in 5 seconds
- Push button and adjustable automatic turn off
- All stainless steel

CALL	JKMV-VT
-------------	----------------



BB-X EXPRESS MODEL

J-KO U.S.A.



- 55" H x 37" W x 31" D
- Weight: 350 lbs.
- Two high speed brushes
- 10 seconds per mat
- Features start push button and adjustable automatic turn off
- All stainless steel

CALL	JKBBX
-------------	--------------



J-KO offers custom decals at no extra cost.

Customize the graphics on your mat cleaners when placing your order!





SENSOR DYNAMIX



SELF-SERVE PRESSURE MONITORING SENSOR

SENSOR DYNAMIX

One of Sensor Dynamix's most popular sensors is their Self-Serve Pressure unit. This device remotely monitors self-serve high-pressure cycles in real time to increase efficiencies and check for malfunctions. Instant notifications for virtually all malfunctions or failures, which helps recapture lost revenue with drastically decreased response times.

FEATURES:

- Manage device and view all data through the SD Live app
- 1/4" NPT Pressure transmitter
- Power: 110V AC wall outlet
- 6ft power cable
- 24V AC coil (different voltages available with special order)
- 3' coil wiring
- WiFi connectivity
- Waterproof
- High accuracy
- Small, compact design
- Simple installation

\$399.00 **PSA**

Monthly fee required.

Register at www.SensorDynamix.com/Registration/Kleen-Rite when placing order.



AUTOMATIC PRESSURE MONITORING SENSOR

SENSOR DYNAMIX

One of Sensor Dynamix's most popular sensors is their In-Bay Automatic Pressure unit. This device remotely monitors in-bay automatic high-pressure cycles in real time to increase efficiencies and check for malfunctions. Instant notifications for virtually all malfunctions or failures, which helps recapture lost revenue with drastically decreased response times.

FEATURES:

- Manage device and view all data through the SD Live app
- 1/2" NPT Pressure transmitter
- Power: 110V AC wall outlet
- 6ft power cable
- 110V AC coil (different voltages available with special order)
- 3' coil wiring
- WiFi connectivity
- Waterproof
- High accuracy
- Small, compact design
- Simple installation

\$399.00 **PAA**

Monthly fee required.

Register at www.SensorDynamix.com/Registration/Kleen-Rite when placing order.



LOW PRESSURE MONITORING SENSOR

SENSOR DYNAMIX

Sensor unit that monitors a variety of potential issues with the low-pressure auxiliary systems at car washes. Get instant notifications to your smart phone using the SD Live app. You can also schedule maintenance schedule reminders!

FEATURES:

- Manage device and view all data through the SD Live app
- 1/4" NPT pressure transmitter
- Power: 110V AC wall outlet
- 6ft power cable
- 110V AC coil (different voltages available with special order)
- 3' coil wiring
- WiFi connectivity
- Waterproof
- High accuracy
- Small, compact design
- Simple installation

\$399.00 **PLA** For low-pressure auxiliary systems
\$399.00 **PLA-A** For air compressors

New!

Monthly fee required.

Register at www.SensorDynamix.com/Registration/Kleen-Rite when placing order.



AUTOMATIC STATUS AND REVENUE MONITORING SENSOR

SENSOR DYNAMIX

Real-time remote monitoring of in-bay automatic pay stations to increase efficiencies or check for malfunctions. This sensor device monitors all revenue and sends instant notifications triggered by out-of-order malfunctions, dramatically decreasing unexpected downtime.

FEATURES:

- Manage device and view all data through the SD Live app
- Power: 110V AC
- 110V AC coil for status trigger (different voltages available with special order)
- 24V AC coils for wash counting (different voltages available with special order)
- 3' wiring length
- WiFi connectivity
- Waterproof
- Small, compact design
- Simple installation

\$279.00 **AAA**

Monthly fee required.

Register at www.SensorDynamix.com/Registration/Kleen-Rite when placing order.



SENSOR DYNAMIX

BILL CHANGER STATUS MONITORING SENSOR

SENSOR DYNAMIX

Sensor unit that monitors out-of-order malfunctions on bill changers. Compatible with any age of bill changer.

FEATURES:

- Manage device and view all data through the SD Live app
- Power: 110 VAC
- Common 110 VAC or 24 VDC coils (different voltages available with special order)
- 3' wiring length
- WiFi connectivity
- Waterproof
- Small, compact design
- Simple installation

\$199.00	SBA	Compatible with all others
\$199.00	SBA-H	For Hamilton Bill Changer
\$199.00	SBA-A	For American Bill Changer

Monthly fee required. Register at www.SensorDynamix.com/Registration/Kleen-Rite when placing order.

SELF-SERVE REVENUE MONITORING SENSOR

SENSOR DYNAMIX

This sensor monitors your self-serve bay revenue in real-time! This includes all customer transactions: credit cards, cash, coin, and any other revenue sources.

FEATURES:

- Manage device and view all data through the SD Live app
- 24V AC coin system required
- Includes 24V AC to 5V DC power supply for sensor
- WiFi connectivity (includes external mounted antenna)
- Waterproof
- High accuracy
- Small, compact design
- Simple installation

\$149.00	RSA
-----------------	------------

Monthly fee required.

Register at www.SensorDynamix.com/Registration/Kleen-Rite when placing order.

AIR TEMPERATURE MONITORING SENSOR

SENSOR DYNAMIX

One of our most efficient sensors monitors any air temperature in real time to increase efficiencies or check for malfunctions.

FEATURES:

- Manage device and view all data through the SD Live app
- Power: 110V AC wall outlet
- 6' power cable
- WiFi connectivity
- Waterproof
- High accuracy
- Small, compact design
- Simple installation

\$470.99	TAA
-----------------	------------

Monthly fee required.

Register at www.SensorDynamix.com/Registration/Kleen-Rite when placing order.

LIQUID TEMPERATURE MONITORING SENSOR

SENSOR DYNAMIX

This sensor monitors any liquid temperature in real-time to increase efficiencies and check for malfunctions. The most popular utilizations include floor heat systems and constant water boilers. Its customizable thresholds allow for instant notifications for any circumstance.

FEATURES:

- Manage device and view all data through the SD Live app
- Power: 110V AC wall outlet
- ½" NPT
- 6' power cable
- WiFi connectivity
- Waterproof
- High accuracy
- Small, compact design
- Simple installation

\$179.00	TLA
-----------------	------------

Monthly fee required.

Register at www.SensorDynamix.com/Registration/Kleen-Rite when placing order.

INTERNAL LIQUID LEVEL MONITORING SENSOR

SENSOR DYNAMIX

Sensor unit that monitors liquid levels in applications like raw chemicals and spot-free rinse tanks.

FEATURES:

- Manage device and view all data through the SD Live app
- Customizable for any liquid material compatibility
- Power: 110V AC wall outlet
- 4' power cable
- WiFi connectivity
- Waterproof
- High accuracy
- Small, compact design
- Simple installation

\$449.00	LIA
-----------------	------------

Monthly fee required. Register at www.SensorDynamix.com/Registration/Kleen-Rite when placing order.

EXTERNAL LIQUID LEVEL MONITORING SENSOR

SENSOR DYNAMIX

Sensor unit that monitors liquid levels in applications like rinse water and chemical mixing reservoirs.

FEATURES:

- Manage device and view all data through the SD Live app
- Customizable for any liquid material compatibility
- Power: 110V AC wall outlet
- 4' power cable
- WiFi connectivity
- Waterproof
- High accuracy
- Small, compact design
- Simple installation

\$449.00	LEA
-----------------	------------

AUTOMATICS & TUNNELS

ROLLERS AND CHAINS



CONVEYOR LENGTH IN FEET	X458 10' SECTION	ROLLER SPACING ON CONVEYOR			
		7'-4" ROLLER SPACING		3'-6" & 3'-4" ROLLER SPACING	
		ROLLERS	CHAIN SECTION	ROLLERS	CHAIN SECTION
40	8	11	10	22	21
45	9	12	11	24	23
50	10	14	13	27	26
55	11	15	14	30	29
60	12	16	15	32	31
65	13	18	17	35	34
70	14	19	18	38	37
75	15	20	19	41	40
80	16	22	21	43	42
85	17	23	22	46	45
90	18	24	23	49	48
95	19	26	25	51	50
100	20	27	26	54	53
105	21	29	28	57	56
110	22	30	29	60	59
115	23	31	30	62	61
120	24	33	32	65	64
125	25	34	33	68	67
130	26	35	34	70	69
135	27	37	36	73	72
140	28	38	37	76	75
145	29	39	38	78	77
150	30	41	40	81	80
155	31	42	41	84	83
160	32	43	42	87	86
165	33	45	44	89	88
170	34	46	45	92	91
175	35	47	46	95	94
180	36	49	48	97	96
185	37	50	49	100	99

AUTOMATICS & TUNNELS

ROLLER REPLACEMENT PARTS

MACNEIL®

VT125
COMPLETE UNIT

VT2000 & MACNEIL® CONVEYOR ROLLER ASSEMBLY REPLACEMENT PARTS

PRICE	PART	DESCRIPTION
\$101.82	RYVT125	Roller Assembly for Macneil, Motor City, and Ryko
\$15.95	RYVT125A	Replacement Roller, red, outrigger wheel for roller assembly #VT125, for VT2000 and will fit MacNeil conveyor
\$13.70	RYVT125B	Replacement Wheel Pusher, yellow, for roller assembly #VT125, for VT2000 and will fit MacNeil conveyor
\$9.10	RYVTB4	Bushing Kit for RYVT125 Contains a set of 4/1.125" O.D. X .760 I.D. X 1.400 long

California WARNING
PROPOSITION 65

California WARNING
PROPOSITION 65

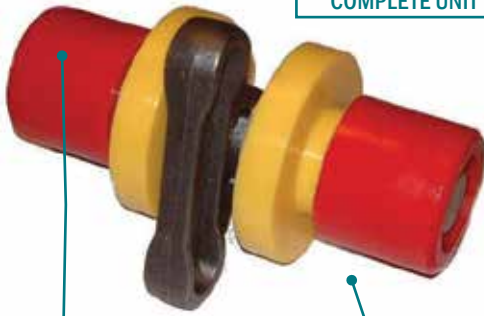

VT125A ONLY

VT125B ONLY



BUSHING KIT

ECONOCRAFT®

HANNA™ RCV STYLE



ECONOCRAFT® REPLACEMENT ROLLER REPLACEMENT PARTS

- Welded shaft

\$78.93	ECRCV214	2 1/4"
\$82.31	ECRCV234	2 3/4"



KLEEN-RITE REPLACEMENT ROLLER FOR HANNA™ STYLE RCV ROLLER KLEEN-RITE'S REPLACEMENT ROLLERS

- Bolted Shaft
- RCV Standard Roller with 1" W x 3 1/2" D steel wheel
- CHAIN ATTACHMENT SOLD SEPARATELY

PRICE	PART #	IDLER WHEEL
\$99.00	RCVR214	2 1/4" Wide
\$102.46	RCVR234	2 3/4" Wide



PUSHER WHEEL HANNA STYLE RCV ROLLER REPLACEMENT PARTS

- 2 required
- 3" x 3 3/4" tire plastic

\$8.47	RCVTP	Red
\$9.84	RCVTPY	Yellow



BUSHING HANNA STYLE RCV ROLLER REPLACEMENT PARTS

- 2 Required
- 5/8" inner diameter

\$4.00	RCVB
--------	------



NYLON LOCK NUT REPLACEMENT PARTS

- (2) Required • 5/8"

\$0.50	37138
--------	-------



1/2" x 3/4" HEX BOLT REPLACEMENT PARTS

- 2 required

\$0.37	13203
--------	-------



TAKE UP DRUM WELDMENT REPLACEMENT PARTS

- For Macneil XR1000

\$296.00	MAC550
----------	--------

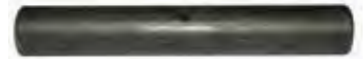

REAR AXLE CROSS REPLACEMENT PARTS

- 7/8"

\$9.88	RCVRA
--------	-------



STEEL WASHER REPLACEMENT PARTS

\$0.13	3012	1/2" (2) required
\$0.18	33094	7/8" (2) required



FRAME REPLACEMENT PARTS

- 1 Required
- BUSHINGS NOT INCLUDED

CALL	RCVFRAME
------	----------



FRONT SHAFT REPLACEMENT PARTS

- 1 Required • 5/8" D x 9 3/4" L

\$11.00	RCVFS
---------	-------



STEEL WHEEL REPLACEMENT PARTS

- 2 Required • 1" x 3 1/2" Diameter

\$21.30	RCVSW
---------	-------

AUTOMATICS & TUNNELS

ROLLER AND CHAIN KITS

KLEEN-RITE CORP.

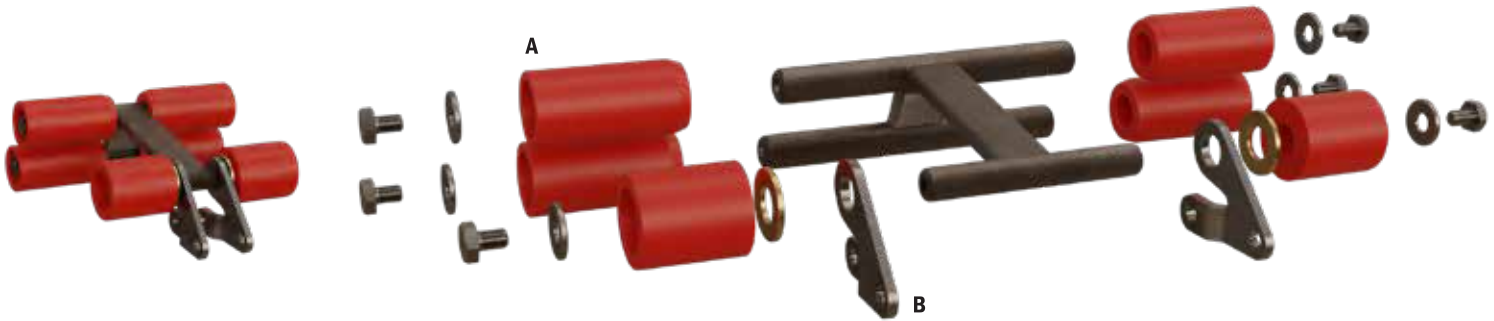

2-1/4" HANNA STYLE: LOW-PROFILE ROLLER KIT



PRICE	LETTER	QTY.	PART	DESCRIPTION
\$56.58	A	6	6WLPR214 (Roller)	Red Rollers: 2-1/4" idler wheel for Hanna-style car wash automatic tunnels. 6 wheels.
\$9.93	B	2	D88KALL (Driver Link) D88KARL (Passenger Link)	Use with D88K model conveyor chain. The perfect solution when you just have a few broken, bent, or worn out links in your chain.
\$42.12	C	16	D88K-16 (Chain)	Made with durable steel 2.609 pitch. Single section with 16 pitches
\$89.31	C	34	D88K-34 (Chain)	Made with durable steel 2.609 pitch. Single section with 34 pitches



2-1/4" HANNA STYLE: HIGH PROFILE ROLLER KIT



PRICE	LETTER	QTY.	PART	DESCRIPTION
\$55.10	A	6	6WHPR214 (Roller)	Red High Profile Rollers: 2-1/4" replacement wheels. 6 wheel.
\$9.93	B	2	D88KALL (Driver Link) D88KARL (Passenger Link)	Use with D88K model conveyor chain. The perfect solution when you just have a few broken, bent, or worn out links in your chain.
\$89.31	C	34	D88K-34 (Chain)	Durable steel 2.609 pitch. Single section with 34 pitches.

AUTOMATICS & TUNNELS

KLEEN-RITE CORP.

ROLLER AND CHAIN KITS

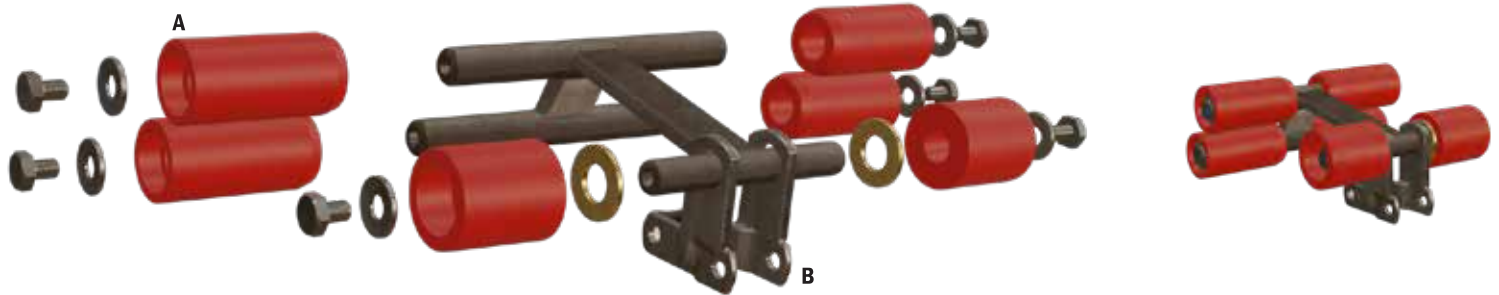

2-3/4" LOW PROFILE ROLLER WITH M2 LINK KIT

PRICE	LETTER	QTY.	PART	DESCRIPTION
\$71.65	A	6	6WLPR234-M2 (Roller)	Red Rollers: 2-3/4" idler wheel for Hanna-style car wash automatic tunnels. 6 wheel.
\$11.01	B	2	D88KM2 (Link)	Fits on D88K conveyor chain. M2 style link. Steel construction.
\$42.12	C	16	D88K-16 (Chain)	Made with durable steel and measures 3' 6" in length. 2.609 pitch. Single section with 16 pitches



2-3/4" HIGH PROFILE ROLLER WITH M2 LINK KIT

PRICE	LETTER	QTY.	PART	DESCRIPTION
\$58.48	A	6	6WHPR234-M2 (Roller)	Red High Profile Rollers: 2-3/4" replacement wheels. 6 wheel.
\$11.01	B	2	D88KM2	Fits on D88K conveyor chain. M2 style link. Steel construction.
\$42.12	C	16	D88K-16 (Chain)	Made with durable steel 2.609 pitch. Single section with 16 pitches.
\$89.31	C	34	D88K-34 (Chain)	Made with durable steel 2.609 pitch. Single section with 34 pitches.



AUTOMATICS & TUNNELS

ROLLER AND CHAIN KITS

KLEEN-RITE CORP.



2-3/4" MID-PROFILE ROLLER IDLERS KIT



PRICE	LETTER	QTY.	PART	DESCRIPTION
\$78.54	A	6	MPR234Y (Roller)	Yellow Rollers: idler wheel with a bolted shaft for added effectiveness
\$62.48	B	2	SC78M2 (Link)	Replaces a worn or damaged carrier link for SC78 conveyor chain.
\$38.93	C	16	SC78-16 (Chain)	16 pitches total, and measures 3' 6" in length. This chain uses rivets; chain with cotter and pin connection. Not included , but available: Replacement cotter and pin set (SC78P) Replacement pin (SC78P-C); S78 chain with rivets (SC78-16)
\$41.61	-	16	SC78PC-16 (Not included in kit)	16 pitches total, and measures 3' 6" in length. 2.609 pitch; 1" side bar height; 1/4" side bar thickness. Uses cotters and pins; chain with rivet connection is available

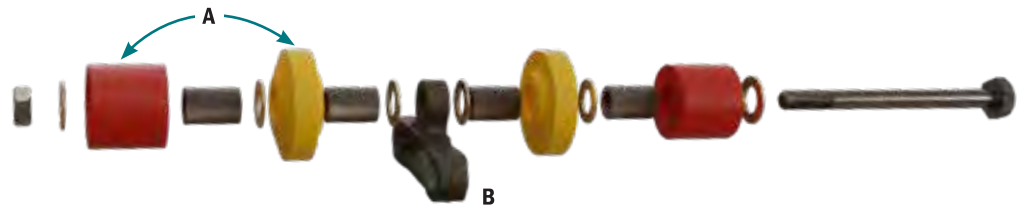

RYKO CONVEYOR WHEEL PUSHER KIT



PRICE	LETTER	QTY.	PART	DESCRIPTION
\$101.82	A	2 pushers, 2 rollers	RYVT125 (Roller Assembly)	Wheel pushers and rollers are made of polyurethane. Used with Macneil and Motor City, and Ryko. RYVT125B (Pushers Only), RYVT125A (Rollers Only)
\$13.13	B	1	X458CL (Carrier Link)	Use this steel carrier link to replace any worn, missing, or damaged links in a X458 conveyor chain
\$22.06	C	1	X458 (Chain)	10' Steel Car Wash Conveyor Chain. Individual components available: Pin (X458PIN), Center Link (X458LINK), Side Bar (X458BAR)

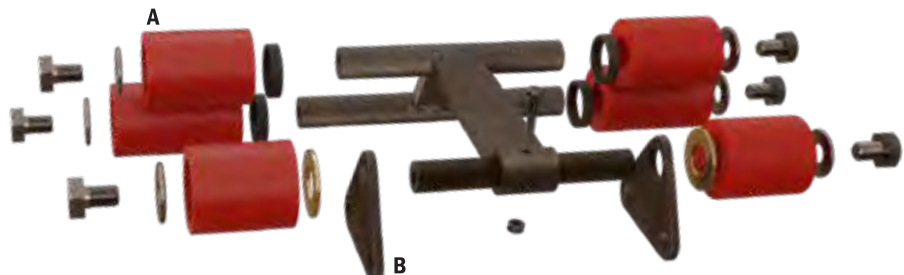

2-1/4" IDLER: BELANGER REPLACEMENT



PRICE	LETTER	QTY.	PART	DESCRIPTION
\$55.23	A	6	B6WL214 (Roller)	Welded shaft. Sturdy red plastic construction.
\$13.51 ea	B	2	TRIPL (Link)	7/8" Link that features a right or left design. Link is made with a durable construction to match the original.
\$97.18	C	1	C188-10 (Pin & Cotter)	Designed with the pin and cotter on the same side of the chain on each link. Sold in 10 foot increments.

AUTOMATICS & TUNNELS

ROLLER REPLACEMENT PARTS

HANNA™ 6 WHEEL LOW PROFILE STYLE



6 WHEEL LOW PROFILE ROLLER

HANNA REPLACEMENT PARTS

• Chain attachment sold separately

2 1/4" WIDE IDLER WHEEL		
PRICE	PART #	COLOR
\$56.58	6WLPR214	Red
\$57.33	6WLPR214Y	Yellow
2 3/4" WIDE IDLER WHEEL		
PRICE	PART #	COLOR
\$59.95	6WLPR234	Red
\$59.95	6WLPR234Y	Yellow

6 WHEEL LOW PROFILE ROLLER WITH M2 LINK

HANNA REPLACEMENT PARTS

• Chain attachment sold separately

2 1/4" WIDE IDLER WHEEL		
PRICE	PART #	COLOR
\$56.58	6WLPR214-M2	Red
\$64.78	6WLPR214Y-M2	Yellow
2 3/4" WIDE IDLER WHEEL		
PRICE	PART #	COLOR
\$71.65	6WLPR234-M2	Red
\$79.10	6WLPR234Y-M2	Yellow

6 WHEEL LOW PROFILE ROLLER - BOLTED SHAFT

HANNA REPLACEMENT PARTS

• Chain attachment sold separately

2 1/4" WIDE IDLER WHEEL		
PRICE	PART #	COLOR
\$62.65	6WLPR214Y-B	Yellow
2 3/4" WIDE IDLER WHEEL		
PRICE	PART #	COLOR
\$65.28	6WLPR234Y-B	Yellow



LOW PROFILE FRAME

HANNA REPLACEMENT PARTS

• (1) Required

\$34.89	6WRLPF
---------	--------



PUSHER WHEEL

HANNA REPLACEMENT PARTS

4 REQUIRED

• 2" D x 4" L x 1" inner diameter

\$5.49	6WP	Red
\$4.93	6WPY	Yellow

HANNA™ 6 WHEEL HIGH PROFILE STYLE



STYLE 6 WHEEL HIGH PROFILE ROLLER

HANNA REPLACEMENT PARTS

• Chain attachment sold separately

PRICE	PART #	IDLER WHEEL
\$55.10	6WHPR214	2 1/4" Wide
\$58.48	6WHPR234	2 3/4" Wide

STYLE 6 WHEEL HIGH PROFILE ROLLER WITH M2 LINK

HANNA REPLACEMENT PARTS

• Chain attachment sold separately

PRICE	PART #	IDLER WHEEL
\$55.10	6WHPR214-M2	2 1/4" Wide
\$58.48	6WHPR234-M2	2 3/4" Wide

HIGH PROFILE FRAME

HANNA REPLACEMENT PARTS

• (1) Required

\$46.25	6WRHPF
---------	--------

PUSHER WHEEL

HANNA REPLACEMENT PARTS

4 REQUIRED

• 2" D x 4" L x 1" inner diameter

\$5.49	6WP	Red
\$4.93	6WPY	Yellow

FOR HANNA™, ECONOCRAFT®, SONNY'S®, & BELANGER® ROLLERS

IDLER WHEEL

ROLLER PARTS

2 REQUIRED

2 1/4" D x 2 1/4" L x 7/8" B		
\$4.73	21/4IW	Red
\$4.57	21/4IWY	Yellow
\$7.27	21/4IWB	Blue
2 1/2" D x 2 3/4" L x 7/8" B		
\$6.28	23/4IW	Red
\$6.05	23/4IWY	Yellow
\$6.26	23/4IWB	Blue
2 1/4" D x 1 1/8" L		
\$1.73	21/4118IW	Red



1/2" x 3/4" HEX BOLT

PARTS

\$0.37	13203
--------	-------



STEEL WASHERS

PARTS

\$0.10	0133012	1/2"
\$0.18	33094	7/8"

AUTOMATICS & TUNNELS

ROLLER REPLACEMENT PARTS

BELANGER® 6 WHEEL ROLLERS



REPLACEMENT ROLLER BELANGER REPLACEMENT PARTS

- Welded shaft

\$55.23	B6WL214	2¼"	Red
\$55.98	B6WL214B	2¼"	Blue
\$58.60	B6WL234	2¾"	Red
\$59.00	B6WL234B	2¾"	Blue
\$59.10	B6WL258	2⅝"	Red
\$60.00	B6WL258B	2⅝"	Blue



PUSHER WHEEL 4 REQUIRED BELANGER REPLACEMENT PARTS

- 2¼" D x 3⅝" L x 1" Bore

\$9.94	BTP318	Red
\$9.92	BTP318B	Blue



PUSHER WHEEL 4 REQUIRED BELANGER REPLACEMENT PARTS

- 2¼" D x 3¾" L x 1" Bore

\$10.53	BTP334	Red
\$9.92	BTP334B	Blue

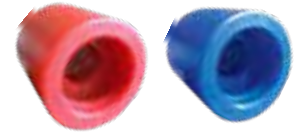

IDLER WHEEL 2 REQUIRED BELANGER REPLACEMENT PARTS

- 2¼" D x 2⅝" L x ⅞" Bore

\$6.95	25/8IW	Red
\$6.78	25/8IWB	Blue

FOR RYKO® ROLLERS

FOR SONNY'S® 4 WHEEL & 6 WHEEL ROLLERS



PUSHER WHEEL SONNY'S ROLLER PARTS

- 3" D x 3⅝" L x 1" B

\$9.46	MPTP3	Red
\$9.92	MPTP3Y	Yellow

FOR SONNY'S® LOW, TALL, & MID PROFILE ROLLERS



PUSHER WHEEL SONNY'S ROLLER PARTS

- 2¼" D x 4" L x 1" B

\$8.73	MPTP214	Red
\$9.92	MPTP214Y	Yellow



RYKO® REPLACEMENT ROLLER REPLACEMENT PARTS

- Welded shaft

\$117.67	RYKO100
-----------------	----------------



RYKO® REPLACEMENT PARTS REPLACEMENT PARTS

\$47.12	RTP	Pusher - No Shoulder
\$17.72	RIW	Idler - Shoulder

REPLACEMENT ROLLERS FOR OTHER MODELS



MID-PROFILE REPLACEMENT ROLLER REPLACEMENT PARTS

- Bolted Shaft

PRICE	PART #	IDLER WHEEL	COLOR
\$75.16	MPR214	2¼"	Red
\$75.91	MPR214Y	2¼"	Yellow

PRICE	PART #	IDLER WHEEL	COLOR
\$78.54	MPR234	2¾"	Red
\$78.54	MPR234Y	2¾"	Yellow



New!

REPLACEMENT LOG LINK ROLLER SONNY'S ROLLER PARTS

- Same materials and measurements as original rollers

\$88.24	CON125S	white
----------------	----------------	-------

AUTOMATICS & TUNNELS

CHAINS & PARTS

D88K



D88KPC PIN & COTTER

D88K PARTS

• Pitch 2.609"

\$55.46	D88KPC-16	Pin & Cotter Chain (16 Pitch Section)
\$117.29	D88KPC-34	Pin & Cotter Chain (34 Pitch Section)



D88K RIVETED

D88K PARTS

• Pitch 2.609"

\$42.12	D88K-16	Riveted Chain (16 Pitch Section)
\$89.31	D88K-34	Riveted Chain (34 Pitch Section)



D88KPC LINKS

D88K PARTS

PRICE	PART #	SIDE
\$9.93	D88KALL	Driver
\$9.93	D88KARL	Passenger



2 3/16" PIN & COTTER

D88K PARTS

\$2.90	D88KDP
---------------	---------------



2 7/16" PIN & COTTER

D88K PARTS

\$3.75	D88KDPL
---------------	----------------



STAINLESS STEEL COTTER ONLY

D88K PARTS

\$0.30	D88KS-S
---------------	----------------



M2 LINK

D88K PARTS

\$11.01	D88KM2
----------------	---------------

D81X



D81X RIVETED CHAIN

D81X PARTS

• Pitch 2.609"

\$81.10 PER FT.	D81X
------------------------	-------------



LINKS

D81X PARTS

PRICE	PART #	SIDE
\$2.37	D81XLL	Driver
\$2.99	D81XRL	Passenger



2 3/16" PIN & COTTER

D81X PARTS

\$2.90	D88KDP
---------------	---------------



D81X PIN & COTTER

D81X PARTS

\$87.55 PER FT.	D81XPC-16	16 Pitch
CALL FOR PRICE	D81XPC-34	34 Pitch



M2 LINK

D81X PARTS

\$13.05	D81XM2
----------------	---------------



CARRIER LINK

D81X PARTS

\$4.35	D81XH-T
---------------	----------------



PIN & COTTER FOR D81HX

D81X PARTS

\$2.25	D81XHP
---------------	---------------

X458 & X348



CHAIN SECTIONS

X458 & X348 PARTS

• Sold in 10 ft. sections - Price is per 10 feet

\$86.00 PER 10 FT.	X348
\$107.07 PER 10 FT.	X458



CARRIER LINK

X348 & X458 PARTS

\$13.13	X458CL
----------------	---------------



CARRIER LINK

X348 & X458 PARTS

\$22.06	CLX458
----------------	---------------



CARRIER LINK

X348 & X458 PARTS

\$22.06	CLX458-M2
----------------	------------------



BAR

X348 & X458 PARTS

\$4.75	X458BAR
---------------	----------------



PIN

X348 & X458 PARTS

\$2.40	X458PIN
---------------	----------------



CARRIER LINK

X348 & X458 PARTS

\$25.61	CLX348
----------------	---------------

AUTOMATICS & TUNNELS

CHAINS & PARTS

C188



C188 (PITCH 2.609")
C188 CHAINS & PARTS

- Sold in 10 ft. sections
- Pin & Cotter Chain
- Same Side Steel Cotters

\$97.18 PER 10 FT C188-10



BLOCK LINK
C188 CHAINS & PARTS

\$4.11 C188BLOCK



7/8" RIGHT OR LEFT LINK
C188 CHAINS & PARTS

\$4.58 TRIPL



C188 PIN & COTTER
C188 CHAINS & PARTS

\$2.07 188P

SC78



SC78 & SC78PC (PITCH 2.609")
MISCELLANEOUS PARTS

- Riveted pin & cotter

\$38.93	SC78-16	Riveted Chain (16 Pitch Section)
\$41.61	SC78PC-16	Pin & Cotter Chain (16 Pitch Section)



M2 LINKS
SC78 CHAINS & PARTS

\$11.05 SC78M2



PIN & COTTER
SC78 CHAINS & PARTS

\$2.75 SC78P

CHAINS, BUSHINGS & SPROCKETS



LOG CHAIN (3½" PITCH)
MISCELLANEOUS PARTS

- Heat treated

\$13.99 LOGCH



TAPERED LOCK BUSHINGS
MISCELLANEOUS PARTS

- 2¼"

\$41.64 TLB2517-214



12T SHAFT TAKE UP SPROCKET
MISCELLANEOUS PARTS

\$89.99	SPROCK-TU12	11"
\$86.41	SPROCK-TU12SON	10 3/16"



12 TOOTH SPROCKET
MISCELLANEOUS PARTS

- For D81X, D88K, C188, SC78 Chains

\$122.99
SPROCKET12



4 TOOTH SPROCKET
MISCELLANEOUS PARTS

- For X458

\$139.00
SPROCKET458

SPIDERS & COUPLINGS



HYTREL PLASTIC



BUNA RUBBER



URETHANE PLASTIC

LOVEJOY SPIDERS
MISCELLANEOUS PARTS

PRICE	PART #	DESCRIPTION	MATERIAL	COLOR
\$27.85	FCS075H	L075/AL075	Hytre Plastic	Tan
\$37.15	FCS090H	L090/AL090, L095/AL095	Hytre Plastic	Tan
\$88.39	FCS099H	L099/AL099, L100/AL100	Hytre Plastic	Tan
\$9.48	FCS075B	L075/AL075	Buna Rubber	Black
\$12.25	FCS090B	L090/AL090, L095/AL095	Buna Rubber	Black
\$25.80	FCS099B	L099/AL099, L100/AL100	Buna Rubber	Black
\$51.25	FCS099U	L099/AL099, L100/AL100	Urethane Plastic	Blue
\$97.29	FCS110U	L110/AL110	Urethane Plastic	Blue



SPLIT



NOT SPLIT

FLEX COUPLINGS
MISCELLANEOUS PARTS

PRICE	PART #	DESCRIPTION
\$15.65	FC4JES	Flex Coupling, Split, EPDM
\$27.37	FC5JES	Flex Coupling, Split, EPDM
\$43.03	FC6JES	Flex Coupling, Split, EPDM
\$54.75	FC7JES	Flex Coupling, Split, EPDM
\$50.87	FC7JE	Flex Coupling, EPDM
\$74.32	FC8JES	Flex Coupling, Split, EPDM

AUTOMATICS & TUNNELS

BEARINGS, FLANGES AND COUPLERS



ER BEARING INSERTS AUTOMATICS HARDWARE

PRICE	KR #	MFG. #	SIZE	DESCRIPTION
\$20.48	SER16	ER205-16	1"	Bearing
\$36.96	SER24	ER208-24	1½"	Bearing
\$25.31	HSBS21005F	ER206-19	1¾"	Bearing W/ Lock Collar



2 BOLT FLANGE BEARING WITH SET SCREW LOCK AUTOMATICS HARDWARE

PRICE	KR PART #	MFG. PART #	SIZE
\$28.76	UCFT20516	UCFL205-16	1"
\$42.47	RY240	UCFL207-20	1¼"
\$50.95	RY245	UCFL208-24	1½"
\$69.11	UCFT21031	UCFL210-31	1⅝"
\$107.94	UCNPFL207-21	UCNPFL207-21	1⅞"



BEARING INSERTS AUTOMATICS HARDWARE

PRICE	KR #	MFG. #	SIZE
\$27.43	UC20720	UC206-20	1¼"
\$23.54	UC20620	UC207-20	1¼"



HANGER BEARINGS WITH SET SCREW LOCK AUTOMATICS HARDWARE

- Industrial cast iron for high durability and a long-lasting service life
- Standard duty, anti-rotation pin with an B-type seal

PRICE	KR #	MFG. #	SIZE
\$31.69	UCHA20516	UCHA205-16	1"
\$48.30	UCHA20720	UCHA207-20	1¼"



3 BOLT FLANGE BEARINGS WITH SET SCREW LOCK AUTOMATICS HARDWARE

- Reliable and durable bearing for your conveyor units The perfect accessory for your automatic car wash bays
- Cast iron housing with a wide inner race bearing and B-type seal

PRICE	KR #	MFG. #	SIZE
\$32.43	UCFB20210	UCFB202-10	5/8"
\$48.30	UCFB20720	UCFB207-20	1¼"



4 BOLT FLANGE BEARINGS WITH SET SCREW LOCK AUTOMATICS HARDWARE

PRICE	KR #	MFG. #	SIZE
\$35.13	UCF20619	UCF206-19	1¾"
\$50.96	UCF20824	UCF208-24	1½"
\$50.95	UCF20825	UCF208-25	1¾"
\$69.11	UCF21031	UCF210-31	1⅝"
\$69.11	UCF21032	UCF210-32	2"
\$84.93	UCF21132	UCF211-32	2"

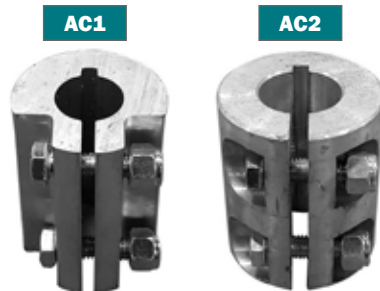

ALUMINUM COUPLERS AUTOMATICS HARDWARE

- Get a secure connection for your piping to ensure proper liquid transfer for pressure wash applications! A great choice for car washes and other industrial water or wash applications!

PRICE	PART #	SIZE
\$12.99	AC1	1" x 1"
\$28.87	AC2	1" x 1¼"



2 BOLT PILLOW BLOCK WITH SET SCREW LOCK AUTOMATICS HARDWARE

PRICE	KR PART #	MFG. PART #	SIZE
\$30.35	UCP20516	UCP205-16	1"
\$37.74	UCP20619	UCP206-19	1¾"
\$49.50	RY241	UCP207-20	1¼"
\$52.94	UCP20824	UCP208-24	1½"
\$73.94	UCP21032	UCP210-32	2"

AUTOMATICS & TUNNELS

BEARINGS, FLANGES AND COUPLERS



TAPERED BASE PILLOW BLOCK BEARINGS WITH SET SCREW LOCK
AUTOMATICS HARDWARE

PRICE	PART #	MFG. PART #	SIZE
\$40.47	UCPA20620 3" on center	UCPA206-20	1 1/4"
\$48.65	UCPA20720 3 3/4" on center	UCPA207-20	1 1/4"



ROD ENDS - MALE THREADED RIGHT HAND WITH ZERK (GREASE FITTING) - 3 PIECE - COMMERCIAL - SINTERED BRONZE
AUTOMATICS HARDWARE

PRICE	KR #	MFG. #	SIZE
\$14.71	VM8G	M8SBZ	1/2"
\$19.30	VM10G	M10SBZ	5/8"
\$25.14	VM12G	M12SBZ	3/4"



ROD ENDS - THREADED RIGHT HAND WITH ZERK (GREASE FITTING) - 3 PIECE - COMMERCIAL - SINTERED BRONZE
AUTOMATICS HARDWARE

PRICE	KR #	MFG. #	SIZE
\$9.03	VF5G	F5SBZ	Rod End - 5/16" Female
\$13.81	VF8G	F8SBZ	Rod End - 1/2" Female
\$18.87	VF10G	F10SBZ	Rod End - 5/8" Female
\$23.93	VF12G	F12SBZ	Rod End - 3/4" Female



ROD ENDS - FEMALE THREADED RIGHT HAND WITH ZERK (GREASE FITTING) - 2 PIECE - METAL-TO-METAL
AUTOMATICS HARDWARE

PRICE	PART #	SIZE
\$6.63	VM5G	Rod End - 5/16" Female
\$10.57	VM7G	Rod End - 1/2" Female



ROD ENDS - MALE THREADED LEFT HAND WITH ZERK (GREASE FITTING) - 3 PIECE - COMMERCIAL - SINTERED BRONZE
AUTOMATICS HARDWARE

PRICE	KR #	MFG. #	SIZE
\$13.48	VM8GL	ML8SBZ	Rod End - 1/2" Male



New!
CAR WASH SERIES PILLOW BLOCK BEARING
AUTOMATICS HARDWARE

PRICE	KR PART #	SIZE
\$103.79	QCWP205-16	1"
\$193.61	QCWP207-20	1.25"
\$329.32	QCWP211-32	2"



New!
CAR WASH SERIES TAPPED-BASE PILLOW BLOCK BEARING
AUTOMATICS HARDWARE

PRICE	KR PART #	SIZE
\$116.07	QCWPA205-16	1"
\$173.61	QCWPA206-20	1.25"
\$218.72	QCWPA207-20	1.25"
\$256.52	QCWPA208-24	1.5"



New!
CAR WASH SERIES 4-BOLT FLANGE
AUTOMATICS HARDWARE

PRICE	KR PART #	SIZE
\$228.72	QCWF208-24	1.5"
\$310.88	QCWF210-31	1 15/16"
\$310.88	QCWF210-32	2"



New!
CAR WASH SERIES 2-BOLT FLANGE
AUTOMATICS HARDWARE

PRICE	KR PART #	SIZE
\$109.24	QCWFL205-16	1"
\$228.72	QCWFL208-24	1.5"



New!
CAR WASH SERIES 3-BOLT FLANGE
AUTOMATICS HARDWARE

PRICE	KR PART #	SIZE
\$112.91	QCWFB205-15	1"
\$168.97	QCWFB206-20	1.25"

HYDRO-SPRAY WASH SYSTEMS, INC. REPLACEMENT PARTS

CLASSIC & RAINMAKER REPLACEMENT PARTS



6 WIRE CENTER POD ASSEMBLY
REPLACEMENT PARTS

\$1,340.00 HSBA93014



1/2" BRONZE PIPE CLAMP
REPLACEMENT PARTS

\$14.40 HSEF22001



BRUSH ASSEMBLY FOR CENTER POD
REPLACEMENT PARTS

\$35.52 HSBA93015 Center Pod
\$72.45 HSBA93016 Ground



CENTER POD COVER
REPLACEMENT PARTS

\$104.24 HSBA93020



KNIFE DISCONNECT FOR CENTER POD
REPLACEMENT PARTS

\$0.96 HSBA93017



RING W/ WIRE FOR CENTER POD
REPLACEMENT PARTS

\$30.63 HSBA93018



PANCAKE SENSOR MOUNT BRACKET
REPLACEMENT PARTS

\$55.71 HSAP12332



CASTLE NUT
REPLACEMENT PARTS

\$13.15 HSCS82153A



STAINLESS STEEL DRIVE SHAFT INNER DISC
REPLACEMENT PARTS

\$74.00 HSAP12312



STAINLESS STEEL DRIVE SHAFT OUTER DISC
REPLACEMENT PARTS

\$74.00 HSAP12313



1 1/4" BUSHING
REPLACEMENT PARTS

\$27.42 HSBS12018



SPROCKET
REPLACEMENT PARTS

\$22.45 HSBS12017



COVER TRACK
REPLACEMENT PARTS

\$130.95 HSBS12019



CHAIN TRACK COUPLING
REPLACEMENT PARTS

\$73.40 HSBS12016



WATER SUPPLY FOR 22 FT. TRACK
REPLACEMENT PARTS

\$1,433.82 HSSA92211



HYDRO-SPRAY WASH SYSTEMS, INC. REPLACEMENT PARTS

RAINMAKER REPLACEMENT PARTS



PHOTO EYE HEATER
REPLACEMENT PARTS

\$34.73 HSEC11681



CARRIAGE PILLOW BLOCK BEARING
REPLACEMENT PARTS

\$181.08 HSBS12031



5" GROOVED RUBBER ROLLERSW/ DELRIN SLEEVE
REPLACEMENT PARTS

\$250.71 HSAP12344



BANNER PHOTO EYE EMITTER
REPLACEMENT PARTS

\$244.32 BPS1040



120/250 VAC THERMAL DISC FOR PHOTO EYE HEATERS
REPLACEMENT PARTS

\$15.67 HSEC11679



ENCODER WHEEL PLASTIC W/ STAINLESS STEEL INSERTS
REPLACEMENT PARTS

\$173.57 HSAP12339A



ROLLER SLIDE PLATE
REPLACEMENT PARTS

\$99.64 HSAP12314



CARRIAGE DRIVE SHAFT 38³/₄" x 1¹/₄"
REPLACEMENT PARTS

\$427.50 HSAP12311



PROXIMITY SWITCH FOR TURCK/ PNP/ MODICON
REPLACEMENT PARTS

\$139.43 TPS1045



CARRIAGE GEAR REDUCER 20: 1
REPLACEMENT PARTS

\$1,189.51 HSBS12000



12MM ENCODER FOR TURCK/ PNP/ MODICON
REPLACEMENT PARTS

\$74.01 HSP11606



CARRIAGE MOTOR AC WASHDOWN 1HP 3PH
REPLACEMENT PARTS

\$967.59 HSEM17236



PHOTO EYE EXTENSION
REPLACEMENT PARTS

\$81.43 HSAP12350



PHOTO EYE HOUSING - TOP
REPLACEMENT PARTS

CALL HSAP12357A



UPRIGHT EXTENSION BRACKET COVER
REPLACEMENT PARTS

CALL HSAP12360



AWG TRAY CABLE WITH PVC JACKET & INSULATION
REPLACEMENT PARTS

- PVC jacketed tray cable
- PVC/nylon insulation
- Class B stranding (ASTM B8)
- Max. Temp: 194°F
- 600 volts
- Suitable for direct burial
- Suitable for NEC class 1 or class 2 locations
- UL type TC-ER
- RoHS compliant
- Fully annealed stranded
- Suitable for exposed run usage per NEC bare copper conductor (ASTM B3) (3 or more conductors)

\$1.47 HSEC11660

HYDRO-SPRAY WASH SYSTEMS, INC. REPLACEMENT PARTS

TOWERS



CLASSIC TOWER

RAINMAKER TOWER

TURBO TOWER



REPLACEMENT/UPGRADE TOWERS

HYDRO-SPRAY

FAMILIAR UPGRADES

- ABS Tower Cover Set (gray) with decals
- Stainless frame | High press. nozzle kit | Water supply kit | Extra tube of grease

SYSTEM IMPROVEMENTS

- Low profile rubber coated wands with nozzles
- Stainless quick release latches for easy removal of ABS Tower
- Wash down motor | Mosmatic stainless swivels | Centralized grease system

COVERS FOR MAINTENANCE

- Removable tower covers for easy maintenance

CLASSIC TOWER

HYDRO-SPRAY

\$18,044.12	HSSA95000CL	Classic Tower 3-Phase Electric Classic Yellow Trim & ABS Skins
\$1,407.35	HSSA92210	Classic Water Supply Kit for 22' Track
\$1,433.82	HSSA92211	Classic Water Supply Kit for 22'8" Track

RAINMAKER TOWER

HYDRO-SPRAY

\$20,000.00	HSSA95000R	Rainmaker Tower 3-Phase Electric Rainmaker Blue Trim & ABS Skins
\$3,438.31	HSSA95002-RM	Tower Cover Set with Decals
\$1,416.18	HSSA92209	Rainmaker Water Supply Kit for Carriage

TURBO TOWER

HYDRO-SPRAY

\$17,466.18	HSSA95000T-1	Turbo Tower 1-Phase Electric Turbo Red Trim & ABS Skins
\$17,466.18	HSSA95000T-2	Turbo Tower 3-Phase Electric Turbo Red Trim & ABS Skins
\$1,407.35	HSSA92207	Turbo Water Supply Kit for 22' Track
\$1,411.76	HSSA92208	Turbo Water Supply Kit for 22'8" Track

PLEASE MEASURE TRACK BEFORE PLACING YOUR ORDER

Rotating wands result in a superior wash product by completely covering the vehicle's surface with a dynamic scrubbing action. Continuous sizing delivers a safe and quality wash process for every vehicle. Rugged design and quality components deliver an equipment package that will provide quality performance year after year with minimum maintenance and repair.

CLASSIC & RAINMAKER TOWER PARTS



STRIKE PLATE

CLASSIC & RAINMAKER PARTS

\$1.67 HSCS83311X



PBB IDLER PULLEY

CLASSIC & RAINMAKER PARTS

\$54.90 HSBS21055



TENSIONER

CLASSIC & RAINMAKER PARTS

\$118.31 HSBS30319



LOVEJOY 18 TENSIONER

CLASSIC & RAINMAKER PARTS

\$118.03 FCSE18



STAINLESS BEARING 4 BOLT FLANGE

CLASSIC & RAINMAKER PARTS

\$217.26 HSBS21001



DOOR CATCH

CLASSIC & RAINMAKER PARTS

\$11.90 HSCS83310X



RUBBERIZED WAND

CLASSIC & RAINMAKER PARTS

\$57.78 AM3815MFZ

HYDRO-SPRAY WASH SYSTEMS, INC. REPLACEMENT PARTS

CLASSIC & RAINMAKER TOWER PARTS



HQ 5/8" BUSHING
CLASSIC & RAINMAKER TOWER PARTS

\$18.39 HSBS30026



5/8" BUSHING
CLASSIC & RAINMAKER TOWER PARTS

\$28.55 HSBS30342



RUBBER IDLER ROLLER
CLASSIC & RAINMAKER TOWER PARTS

\$40.20 HSAP92017



TOWER IDLER SHAFT
CLASSIC & RAINMAKER TOWER PARTS

\$285.45 HSAP95131



LOWER HORIZONTAL COVER (BLACK)
CLASSIC & RAINMAKER TOWER PARTS

CALL HSAP95610



TOWER INSIDE LEG (BLACK)
CLASSIC & RAINMAKER TOWER PARTS

\$633.86 HSAP95615



TOWER OUTSIDE LEG (BLACK)
CLASSIC & RAINMAKER TOWER PARTS

\$670.29 HSAP95620



UPPER HORIZONTAL COVER (BLACK)
CLASSIC & RAINMAKER TOWER PARTS

\$491.90 HSAP95605



RUBBER DRIVE ROLLER
CLASSIC & RAINMAKER TOWER PARTS

\$40.20 HSAP92016



1 3/16" SHAFT SPINDLE BEARING
CLASSIC & RAINMAKER TOWER PARTS

\$25.31 HSBS21005F



SPINDLE
CLASSIC & RAINMAKER TOWER PARTS

\$273.80 HSAP95140W 6 1/2"
\$281.79 HSAP95141W 8 1/2"



H40H18 CHAIN SPROCKET
CLASSIC & RAINMAKER TOWER PARTS

\$61.21 HSBS30238



BEARING HOUSING SQUARE
CLASSIC & RAINMAKER TOWER PARTS

\$305.36 HSAP95114



CARRIAGE SPINNER WAND BEARING
CLASSIC & RAINMAKER TOWER PARTS

\$131.58 HSBS21005



TOWER DRIVE SHAFT
CLASSIC & RAINMAKER TOWER PARTS

\$277.00 HSAP95130

HYDRO-SPRAY WASH SYSTEMS, INC. REPLACEMENT PARTS

CLASSIC & RAINMAKER TOWER PARTS



TENSIONER BRACKET ASSEMBLY
RAINMAKER TOWER PARTS

\$427.50 HSSA95197



GEARBOX REDUCER
RAINMAKER TOWER PARTS

\$1,016.85 HSBS30495



GUIDE ROLLER
RAINMAKER TOWER PARTS

\$57.77 HSAP92100

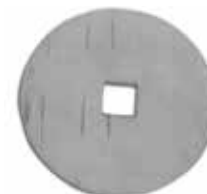

IDLER SHAFT INNER DISC
RAINMAKER TOWER PARTS

\$52.50 HSAP95134

RAINMAKER, CLASSIC & OLDER HYDRO-SPRAY WASH SYSTEM PARTS

MULTI-PURPOSE FOAM GENERATOR

REPLACEMENT PARTS

- PVC Construction
- Maintenance Free
- No Plug Design
- Dual & Single 3/8" Push Lock Inlet Connection
- Single 3/8" Push Lock Outlet Connection



7 1/2" MULTIPURPOSE FOAM GENERATOR
REPLACEMENT PARTS

\$48.11 TFSA001



11 1/2" MULTIPURPOSE FOAM GENERATOR W/ DUAL INLETS
REPLACEMENT PARTS

\$81.89 TFSA005



TRI-FOAMER HEAD 13 HOLE UNIT - 3/8" FPT
REPLACEMENT PARTS

\$86.54 HSMPPV48300



POWER CORD FOR TOWER 20' - 14 GAUGE - 6 STRAND
REPLACEMENT PARTS

\$86.94 HSAP92198

RAINMAKER, CLASSIC & OLDER HYDRO-SPRAY WASH SYSTEM PARTS



1 CHANNEL MULTIPLEXER
REPLACEMENT PARTS

\$144.69 TPPA0324VDC



11 PIN SOCKET (TELCO)
REPLACEMENT PARTS

\$8.15 TLR1105



HYDRO-SPRAY WASH SYSTEMS, INC. REPLACEMENT PARTS

RAINMAKER, CLASSIC & OLDER HYDRO-SPRAY WASH SYSTEM PARTS



1 1/4" SPLIT TAPER
REPLACEMENT PARTS

\$9.95 | PL0027



3 3/4" OD DOUBLE PULLEY
REPLACEMENT PARTS

\$52.20 | PL0150



3 3/4" OD SINGLE PULLEY
REPLACEMENT PARTS

\$33.24 | PL0115



CABLE - 20 GA/18 COND
REPLACEMENT PARTS

\$4.75 PER FT. | HSEC11668

REPLACEMENT FOR 2 POSITION RAMPED
FLOOR SWITCH PART NUMBER HSP92208



24" x 30" CAR WASH MAT SYSTEM
TAPESWITCH®

TECHNICAL DATA:

- **VOLTAGE:** 24 VAC or DC
- **CURRENT RATING:** 1 Amp
- **ACTUATION FORCE:** 15 lbs. nominal
- **MATERIAL:** Molded PVC
- **MOUNTING:** 4 thru holes on 3/16" steel plate
- **COLOR:** Gray

PRICE	PART #	DESCRIPTION
\$560.03	TSCWRS2430-Y	Mat System - 2 Mats
\$280.01	TSCWRS2430L-Y	LEFT side mat ONLY
\$280.01	TSCWRS2430R-Y	RIGHT side mat ONLY

RAINMAKER, CLASSIC & OLDER HYDRO-SPRAY WASH SYSTEM PARTS

COG BELTS REPLACEMENT PARTS



\$34.94	BLCBX100	BX100 Cog Belt	\$22.11	BLCBX61	BX61 Cog Belt
\$15.97	BLCBX38	BX38 Cog Belt	\$28.22	BLCBX84	BX84 Cog Belt
\$20.08	BLCBX50	BX50 Cog Belt			

OLD STYLE CLASSIC TOWER PARTS



ROLLER GUIDE ARM
OLD STYLE CLASSIC TOWER PARTS

\$264.93 | HSAP92011



IDLER SHAFT
OLD TOWER/WELDED PLATE
OLD STYLE CLASSIC TOWER PARTS

\$229.29 | HSAP91398



3 HOLE SHORT SPINDLE
OLD TOWER 1 1/4"
OLD STYLE CLASSIC TOWER PARTS

\$184.61 | HSAP92003

DECALS & SIGNS



ATTENTION & DIRECTION SIGN
DECALS & SIGNS

\$152.40 | HSSN55120



"FOLD IN MIRRORS" DECAL 3 1/2" x 28 3/4"
DECALS & SIGNS

\$21.86 | HSSN40050

HYDRO-SPRAY WASH SYSTEMS, INC.

RGB GUIDE LITES



RGB GUIDE LITES FLOOR MOUNTED GUIDE SYSTEM



Impress your customers with Hydro-Spray's all new RGB Guide Lites! These color changing LED lights will drive impulsive purchases and help prevent accidents from occurring. With a reinforced structure to prevent against tire traffic, RGB Guide Lites are sure to last!

FEATURES:

- White plastic (UHMW) rails
- Color changing Flex Neon
- Custom Length Linear Foot to meet various bay lengths
- Reinforced structure to protect lights from tire traffic
- Low voltage - safe for wet environments
- Plastic guides attach directly to concrete floor
- Synchronizes with in-bay directional signage

BENEFITS

- Alternative to painted lines/reflective markers
- Faster wash loading
- Reduce customer error
- Help prevent accidents from occurring
- Easy to understand
- Drive Impulsive Purchases
- Quickly captures the attention of the driver

LED LIGHT COLORS



GREEN
ENTER/EXIT



BLUE
BACK UP



RED
STOP

OPTIONS

- Action Lights: Offer chasing/blinking lights for more curb appeal!
- Green: Front Chasing • Blue: Back Chasing • Red: Solid

ALL PACKAGES INCLUDE:

- Pre-wired Control Panel (requires 110V, 20 Amp receptacle or 120V input depending on the application)
- Pre-programmed controller
- Stainless steel hardware
- Relay control (24V inputs)
- (2) 2" x 4" junction boxes

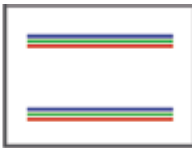

24' PACKAGE RGB GUIDE LITES

- 48' RGB Neon Lights
- 48' Custom UHMW Extrusion

\$3,984.38 HSP0324



32' PACKAGE RGB GUIDE LITES

- 64' RGB Neon Lights
- 64' Custom UHMW Extrusion

\$4,920.00 HSP0332



40' PACKAGE RGB GUIDE LITES

- 80' RGB Neon Lights
- 80' Custom UHMW Extrusion

\$5,165.00 HSP0340



WATERPROOF SPEAKER FLOOR MOUNTED GUIDE SYSTEM

The waterproof automated voice attendant comes standard with 8 custom messages to safely guide customers through your wash. This product is more than just a speaker - it comes with a PLC allowing you to tie in features such as laser light shows, email notifications and more!

PRE-PROGRAMMED MESSAGES INCLUDE:

- Please Drive Forward (with three short beeps prior to voice & repeat voice after beep)
- Stop (with single loud beep then voice)
- Back Up (with three short beeps prior to voice & repeat voice after beep)
- Please Exit Wash, Thank you. (with three short beeps prior to voice, do not repeat voice)
- Cleaning Solution Now Being Applied (with single quiet beep prior to voice, do not repeat voice, 5 sec delay once input is received)
- Tri-Color Conditioner Now Being Applied (with single quiet beep prior to voice, do not repeat voice, 5 sec delay once input is received)
- Wax Treatment Now Being Applied (with single quiet beep prior to voice, do not repeat voice, 5 sec delay once input is received)
- Clearcoat Treatment Now Being Applied (with single quiet beep prior to voice, do not repeat voice, 5 sec delay once input is received)

CALL HSP0300-24 24 VDC

RYKO® REPLACEMENT PARTS

SOFTGLOSS TOP BRUSH PARTS



AIR CYLINDER - 2½" BORE x 8¾" STROKE
RYKO PARTS

\$250.51 RY100



1/4" T x 1/4" MPT ELBOW
RYKO PARTS

\$2.76 FT4ME4



**DOUBLE EYE CLEVIS MOUNT
D250 FOR AIR CYLINDER**

RYKO PARTS

\$32.06	RY115	Mount
CALL	KITA-01	1/2" x 2" Clevis Pin & Cotter



**SINGLE EYE CLEVIS MOUNT
C250 FOR AIR CYLINDER**

RYKO PARTS

\$38.33	RY110	Mount
CALL	KITA-01	1/2" x 2" Clevis Pin & Cotter



**ROD CLEVIS
½-20" UNF THREAD - ½" PIN HOLE**

RYKO PARTS

\$50.57	RY105	Mount
CALL	KITA-01	1/2" x 2" Clevis Pin & Cotter



**WEG MOTOR
1 HP/1800 RPM/3PH/56C-230/460V**

RYKO PARTS

\$461.62 RY385



1" 2-BOLT FLANGE BEARING

RYKO PARTS

\$28.76 UCFT20516



1" DIAMETER FLANGE SHAFT

RYKO PARTS

\$142.93 RY319



**ELECTRA GEAR BOX
SG 25:1 56C LEFT OUTPUT**

RYKO PARTS

\$1,164.60 RY769I



LEFT & RIGHT BEARING BLOCKS

RYKO PARTS

CALL	RY240B	Left Bearing Block
	RY240A	Right Bearing Block



**LOVEJOY SPIDER - L110
URETHANE PLASTIC -
1.180" CENTER HOLE DIAMETER**

RYKO PARTS

\$97.29 FCS110U



**LOVEJOY COUPLER - ALUMINUM
HUB WITH KEYWAY - 1" BORE**

RYKO PARTS

\$76.67 LJH417981

RYKO® REPLACEMENT PARTS

SOFTGLOSS FRONT/REAR BRUSH PARTS



AIR CYLINDER - 2½" BORE x 8¾" STROKE
RYKO PARTS

\$250.51 RY100



¼" T x ¼" MPT ELBOW
RYKO PARTS

\$2.76 FT4ME4



DOUBLE EYE CLEVIS MOUNT D250 FOR AIR CYLINDER
RYKO PARTS

\$32.06	RY115	Mount
CALL	KITA-01	1/2" x 2" Clevis Pin & Cotter



SINGLE EYE CLEVIS MOUNT C250 FOR AIR CYLINDER
RYKO PARTS

\$38.33	RY110	Mount
CALL	KITA-01	1/2" x 2" Clevis Pin & Cotter



ROD CLEVIS ½-20" UNF THREAD - ½" PIN HOLE
RYKO PARTS

\$50.57	RY105	Mount
CALL	KITA-01	1/2" x 2" Clevis Pin & Cotter



2-BOLT FLANGE BEARING
RYKO PARTS

\$50.95	RY245	1½" Bearing
\$42.47	RY240	1¼" Bearing



2-BOLT PILLOW BLOCK BEARING 1 7/16" - CAST IRON
RYKO PARTS

\$45.54 UCP20723



LOVEJOY COUPLERS
RYKO PARTS

\$76.67	LJH417984	1¼" Bore
CALL	LJH417988	1½" Bore



LOVEJOY SPIDER - L110 URETHANE PLASTIC - 1.180" CENTER HOLE DIAMETER
RYKO PARTS

\$97.29 FCS110U



REAR AND FRONT BRUSH FLANGE SHAFTS - 4-BOLT
RYKO PARTS

\$263.88	RY317B	1½" x 16"
\$182.15	RY317	1¼" x 13"



ELECTRA GEARBOX - 25:1 WITH FLANGE
RYKO PARTS

PRICE	PART #	OUTPUT
\$1,142.09	RY769G	Left
\$1,142.09	RY769H	Right



ELECTRA GEARBOX - SG 25:1 56C
RYKO PARTS

PRICE	PART #	OUTPUT
\$1,164.60	RY769I	Left
CALL	RY769J	Right



WEG MOTOR 1 HP/1800 RPM/3PH/56C-230/460V
RYKO PARTS

\$461.62 RY385



SIGN UP FOR OUR WEEKLY EMAIL BLAST!

OUR WEEKLY E-BLAST FEATURES:

- Special Sale Offers
- Car Wash Hot Picks
- Featured Videos
- Sign up on the Kleen-Rite website!
- New Product Info
- Industry Calendar



RYKO® REPLACEMENT PARTS

SOFTGLOSS FRONT/REAR BRUSH PARTS (CONTINUED)



BACK-UP

**FOR USE ON AMBER LIGHT ONLY

OVAL LED LIGHTS WITH PLUG 10 LED - 12V RYKO PARTS

PRICE	PART #	COLOR
\$40.05	RY404G	Green
\$26.64	RY404R	Red
\$26.64	RY404AM	Amber
\$6.61	RY404D	BACK UP DECAL**



SOFTGLOSS WHEEL SCRUBBER PARTS



WEG MOTOR 1 HP/1800 RPM/3PH/56C - 230/460V RYKO PARTS

\$461.62 RY385



GEARBOX WITH TRIANGLE HUB 12.5:1 - C-FACE RYKO PARTS

\$1,026.76 RY769



PHOTO EYE BRACKET - LEFT FRONT RYKO PARTS

CALL RY772A



PHOTO EYE BRACKET - RIGHT FRONT RYKO PARTS

CALL RY772



PHOTO EYE BRACKET EXIT RYKO PARTS

\$71.57 RY772B



PROXIMITY SWITCH BRACKET RYKO PARTS

CALL RYRWS50



GREASE PACK FOR CYLINDER RYKO PARTS

\$2.66 SMC500

SOFTGLOSS WHEEL SCRUBBER & GANTRY DRIVE PARTS



BANNER PHOTO EYE EMITTER AND RECEIVER - WIRE CONNECTION - 6.5' LEAD RYKO PARTS

PRICE	PART #	MFG #	DESC.	POWER
\$262.74	BPS1110	SM30PRL	Receiver	10 - 30 V DC
\$244.29	BPS1115	SMA30PEL	Emitter	Universal 12 - 240V AC/ 10 - 20V DC



WEG MOTOR 1 HP/1800 RPM/3PH/56C - 230/460V RYKO PARTS

\$461.62 RY385



DRIVE GEARBOX HOLLOW SHAFT 30:1 - 1" BORE RYKO PARTS

\$1,026.76 RY769B



1 1/4" 2 BOLT PILLOW BLOCK BEARING RYKO PARTS

\$49.50 RY241

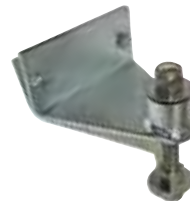

TORQUE ARM 1/2" ID BORE RYKO PARTS

\$103.13 RY769D



IDLER WHEEL RYKO PARTS

\$299.91 RY170



DRIVE WHEEL RYKO PARTS

\$374.63 RY174



1/4" T x 1/4" MPT ELBOW RYKO PARTS

\$2.76 FT4ME4

RYKO® REPLACEMENT PARTS

SOFTGLOSS ELECTRICAL PANEL PARTS



**ALLEN-BRADLEY 3 POLE CONTACTOR
3 PHASE 24VAC 1 HP**
RYKO PARTS

\$152.02 MS18905



**ALLEN-BRADLEY 3 POLE
32 AMP DRYER MOTOR
OVERLOAD PROTECTOR**
RYKO PARTS

CALL MS18960



**ALLEN-BRADLEY 3 POLE
30 AMP FUSE HOLDER**
RYKO PARTS

CALL AB3200



**IDEC 8 BLADE RELAY
1/2" THICK
24VAC RATED TO 8 AMPS**
RYKO PARTS

\$11.07 IDEC2000



**3/4" THICK
SOCKET BASE FOR
8 BLADE RELAY**
RYKO PARTS

\$7.30 IDEC2050



**1/2" THICK
SOCKET BASE FOR
8 BLADE RELAY**
RYKO PARTS

\$5.81 IDEC2052



**EMERGENCY STOP
PUSH SWITCH -
22MM**
RYKO PARTS

\$50.09 IDEC2020



**ENTRY KEY PAD
8 CONDUCTOR
8 PIN**
RYKO PARTS

\$130.21 RY132



**MERCURY SWITCH
17' WIRES - 24V AC**
RYKO PARTS

\$39.53 RYM131



RECLAIM PARTS



**ALLEN-BRADLEY
3 POLE CONTACTOR - 3 PHASE 24VAC 1 HP**
RYKO PARTS

\$152.02 MS18905



**ALLEN-BRADLEY
3 POLE 6.3-10 AMP 3 PHASE RECLAIM
PUMP OVERLOAD CIRCUIT BREAKER**
RYKO PARTS

CALL MS18964



**J & JB SERIES
STARITE PUMP
57 GPM/2HP
230/460V**
RYKO PARTS

CALL JHG3-52H



**STARITE PUMP
2HP/3PH
230/460V**
RYKO PARTS

CALL AP100GL



**PRESSURE SWITCH
30-50 PSI/24-220V**
RYKO PARTS

\$72.56 ST0328



1" NPT HOSE BARB
RYKO PARTS

\$9.59 BFA29-1616



**PARKER VALVE
DIAPHRAGM
REPAIR KIT**
RYKO PARTS

\$56.09 SOPK360



**2" BRONZE
FOOT VALVE**
RYKO PARTS

\$139.41 4105E

RYKO® REPLACEMENT PARTS

DRYER PARTS



FLOW CONTROL WITH FITTING
1/8" M x 1/4" T
RYKO PARTS

\$12.23 SMC146-A



OSCILLATOR AIR CYLINDER
1 1/16" BORE x 1 3/4" BORE
RYKO PARTS

\$97.37 RY251



FLOW CONTROL NEEDLE VALVE
1/8" MPT x 1/8" F
RYKO PARTS

\$14.53 SMC144



1/4" T x 1/4" MPT ELBOW
RYKO PARTS

\$2.76 FT4ME4



RIGHT SIDE LOUVER
RYKO PARTS

\$149.54 RY252F



LEFT SIDE LOUVER
RYKO PARTS

\$97.82 RY252E



AIR MANIFOLD PARTS



35 SERIES MAC
3 WAY SOLENOID
VALVE - 24V AC -
96" WIRE
RYKO PARTS

\$37.34 MAC2250



35 SERIES MAC
3 WAY SOLENOID
VALVE - 1/8" 24V AC -
96" WIRE
RYKO PARTS

\$34.78 MAC2110



45 SERIES MAC 3
WAY SOLENOID
24V AC BASE
RYKO PARTS

\$51.08 MAC2210



AR20K REGULATOR
1/4" NPT PORTS
RYKO PARTS

\$51.08 SMC102



SMC 1/2" NPT
MINI MODULAR FRL
COMBO UNIT
RYKO PARTS

\$126.86 SMC120



1/4" FPT
EXHAUST VALVE
RYKO PARTS

\$20.41 SMC010

CHEMICAL DISTRIBUTION & BAY SWITCHES



BLUE WHITE PUMP
115V/10.6 OZ/MI
RYKO PARTS

\$411.80 BW15N404X



BLUE WHITE INJECTION
FITTING CHECK VALVE
RYKO PARTS

\$41.72 BWPC395N6A



BLUE VITON FOOT VALVE
RYKO PARTS

\$13.12 IN250020



1/4" ID x 1/2" OD
CERAMIC WEIGHT
RYKO PARTS

\$5.60 IN250006



PRESSURE GAUGE
NON-LIQUID FILLED
1/4" REAR MOUNT
RYKO PARTS

\$5.38 GA100R



1/4" WATER
SEPARATOR
WITH BRACKET
RYKO PARTS

\$88.28 SMC125



TAPE SWITCH
10" x 32" L
BLUE 20' LEAD
RYKO PARTS

\$219.60 TSCW1032

RYKO® REPLACEMENT PARTS

RG440 CONVEYOR PARTS



PROXIMITY READ SWITCH - VEHICLE DETECTION
RYKO PARTS

\$22.71 SMC020



PROXIMITY READ SWITCH - VEHICLE DETECTION
RYKO PARTS

\$22.71 SMC021



#16 NORMALLY OPEN AIR SWITCH
RYKO PARTS

\$15.80 AS16



3/8" BELL SIGNAL HOSE - .110 WALL
RYKO PARTS

\$1.00 / FT H00150



LLDPE POLY TUBING - 3/8" / 120PSI / 100FT
RYKO PARTS

\$30.15 PT300BK-100

HYDRAULIC & ELECTRIC DEVICES



2000 SERIES CHAR-LYNN® MOTORS
RYKO PARTS

PRICE	PART#	DESCRIPTION
\$656.86	CL106-1014-006	Motor, 18.7 cu"/ Rev
\$686.22	CL106-1015-006	Motor, 24.9 cu"/ Rev



1760RPM/182TC 230/460 STERLING MOTOR
RYKO PARTS

PRICE	PART#	DESCRIPTION
\$764.50	MSE3000	3HP
\$843.50	MSE3005	5HP

ROLLERS & CHAINS



PUSHER WHEEL FOR VT2000 & MACNEIL®
4" OD x 1 1/8" ID
RYKO PARTS

\$13.70 RYVT125B



ROLLER FOR VT2000 & MACNEIL®
2 3/4" OD x 2 1/4" ID
RYKO PARTS

\$15.95 RYVT125A



CARRIER LINK
RYKO PARTS

\$25.61 CLX348



BAR
RYKO PARTS

\$4.75 X458BAR



PIN
RYKO PARTS

\$2.40 X458PIN



REPLACEMENT ROLLER
RYKO PARTS

- Welded shaft

\$117.67 RYKO100



REPLACEMENT PARTS
RYKO PARTS

\$47.12	RTP	Pusher - No Shoulder
\$17.72	RIW	Idler - Shoulder

CHAIN SECTIONS
RYKO PARTS

- Sold in 10 ft. sections - PRICE IS PER 10 FEET

\$107.07 X458



BAR
RYKO PARTS

\$4.75 X458BAR

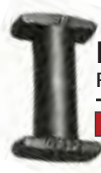

PIN
RYKO PARTS

\$2.40 X458PIN



CENTER LINK
RYKO PARTS

\$4.78 X458LINK

RYKO® POPULAR REPLACEMENT PARTS



WEG MOTOR - TEFC 1 HP/1800 RPM/3PH/56C - 230/460V RYKO PARTS

- Drive for R7B, VOY II, Softgloss, US2001, VT2000 Wrap, Wheel Scrubber, Nova, 2000, Trolley & Rotate on Mon. Hi Impact, w/Blaster on Some Softgloss

\$461.62 RY385



GEAR BOX RYKO PARTS

- Left Front, 25 -1, Flange Shaft, L. Output, Softgloss, Left on Nova & Left Rocker on VT2000

\$1,142.09 RY769G



GEAR BOX RYKO PARTS

- Right Front, 25 -1, Flange Shaft, R. Output, Softgloss, Right on Nova 2000, Right & Left on Wrap VT2000, Right Rocker, On VT2000

\$1,142.09 RY769H



DRIVE WHEEL GEAR BOX RYKO PARTS

- Voyager II, Monarch II, Some Softgloss XS
- 6 Month Warranty

\$1,026.76 RY769B



GEAR BOX RYKO PARTS

- For Foam Brite 30" Right Front, Tall Left Rear Brush, Top Brush, 1", L. Output, 25-1, VOY II, Softgloss XS, VT2000, Rocket, Select-A-Wash

\$1,164.60 RY769I



GEAR BOX RYKO PARTS

- For Foam Brite, 30" Left Front, Right Rear Tall Brush, 1", R. Output, 25-1, VOY II, Softgloss

\$898.35 RY769J



30mm PROXIMITY SWITCH WITH 23' CABLE RYKO PARTS

- For Monarch II Hi Impact, Monarch II Hi Pressure Voyager, Voyager II, VT2000, Softgloss, and Select-a-Wash

\$83.09 RY775



PROXIMITY SWITCH RYKO PARTS

- For VT2000, Impact, OHD, 14526-26

\$90.94 RY776



GANTRY TIMING BELT RYKO PARTS

- 1" x 28". Long, runs full length of track on both sides, pulls gantry

\$428.85 RYRUS45



TROLLEY TIMING BELT RYKO PART

- 1" x 167". Long, pulls trolley from left to right

\$216.49 RYRUS40



COMPLETE TREADLE RYKO PARTS

\$478.65 RYM220 Right Side
\$478.65 RYM240 Left Side



DRIVE SPROCKET RYKO PARTS

- Built before 2002, for VT2000 and MacNeil

\$203.90 RYVT150



2-BOLT BEARING RYKO REPLACEMENT PARTS

PRICE	PART	DESCRIPTION
\$28.76	UCFT20516	1", For Top Brush, All Machines
\$42.47	RY240	1 1/4", For Drive Wheel, R7B, Voyager, Front Brush Shafts/All Machines Except 42" on SoftGloss XS.
\$50.95	RY245	1 1/2", For All Tall Rear Brushes



2-BOLT BEARING RYKO REPLACEMENT PARTS

- Pillow block bearing 1 1/4" wheel bearing for Voyager II, SoftGloss XS and Select-a-Wash

\$49.50 RY241

RYKO® POPULAR REPLACEMENT PARTS



AIR SOLENOID RYKO REPLACEMENT PARTS

- Air Solenoid, Mac Valve 35A-B00-DACA-1BA for most functions on Voyager II, SoftGloss XS, Select-A-Wash

\$58.01 RY506A



AIR SOLENOID BLOWER OSCILLATOR RYKO REPLACEMENT PARTS

- Air Solenoid, Mac Valve 45A-LOO-DACA-1BA for Voyager II, SoftGloss XS, Select-A-Wash

\$73.85 RY504



MAC-REGULATOR RYKO REPLACEMENT PARTS

- Left side of air manifold
- Voyager II, SoftGloss XS, Select-A-Wash

\$44.45 RY506B



TREADLE SPRING STAINLESS STEEL RYKO REPLACEMENT PARTS

- Left or Right side, lifts trip bar for Voyager II, SoftGloss XS, Select-a-Wash

\$23.93 RYM129



MERCURY SWITCH W/ 17' WIRES RYKO REPLACEMENT PARTS

- Treadle switch, attaches to trip bar for all machines

\$39.53 RYM131



TORQUE ARM RYKO REPLACEMENT PARTS

- Attaches to and secures drive wheel gearbox on most machines
- Hot dipped

\$103.13 RY769D



AIR CYLINDER RYKO REPLACEMENT PARTS

- All machines & Thrust Pro Dryer
Follower Nozzle Lift

\$250.51 RY100



TOUCH PAD RYKO REPLACEMENT PARTS

- With "D" plug, entry system. Used in a multi-upgrade coin box.

\$179.71 RY130



BRUSH SHAFT RYKO REPLACEMENT PARTS

PRICE	PART	SIZE	USAGE
\$242.30	RY310	1¼"	Front Side Brush Shaft. Except 42" on SoftGloss XS. Select-A-Wash
\$270.63	RY315	1½"	Tall Rear Brush Shaft. All Machines.
\$176.65	RY320	1"	Top Brush Shaft- All Machines, Except SoftGloss XS, Select-A-Wash

"THE ORIGINAL NEOGLIDE" RYKO REPLACEMENT PARTS

- Neoglide Foam Brush Retro Kits - Convert any bristle machine with this easy to install slide in C-Channel design. Extremely gentle, soft and durable. 75% lighter than cloth means longer life for equipment! No water or grit absorption!
- **ALL HARDWARE INCLUDED**



PART	MACHINE	DESCRIPTION
RYNE01	R7B MACHINE with nylon bristle brushes	(4) 33" side brushes, 66" top brush, (2) 5" window brushes
RYNE02	R7B MACHINE with nylon bristle brushes	(2) 33" front side brushes, (2) 70" tall rear & 66" top brush
RYNE03	VOYAGER with nylon bristle brushes	(2) 33" front side brushes, (2) 70" tall rear & 66" top brush
RYNE04	VOYAGER II with nylon bristle brushes	(2) 33" front side brushes, (2) 70" tall rear & 66" top brush
RYNE05	VOYAGER II with cloth of Foambrite brushes	(2) 33" front side brushes, (2) 70" tall rear & 66" top brush
RYNE06	SOFTGLOSS XS with Foambrite brushes	(2) 33" front side brushes, (2) 70" tall rear & 66" top brush
RYNE07	SOFTGLOSS XS OR MAXX with Foambrite brushes	(2) 44" front side brushes, (2) 70" tall rear & 66" top brush

CALL FOR PRICING

RYKO® POPULAR REPLACEMENT PARTS



WATER VALVE
RYKO REPLACEMENT PARTS

- Aquamatic, 1" NC, for R7B, Voyager

\$256.57 RY161



WATER VALVE
RYKO REPLACEMENT PARTS

- Air operated Aquamatic, 1" with 1/4" Side Tap. Supplies water to car wash

\$268.45 RY160



WATER VALVE REPAIR KIT
RYKO REPLACEMENT PARTS

- For Aquamatic, 1" (RY160 & RY161)

\$71.49 RY165



DRIVE WHEEL
RYKO REPLACEMENT PARTS

- Used on R7B and Voyager car washes only.

\$222.78 RY169



DRIVE WHEEL
RYKO REPLACEMENT PARTS

- For Voyager II, SoftGloss XS, Monarch II, U.S. 201, Select-A-Wash.

\$374.63 RY174



IDLER WHEEL
RYKO REPLACEMENT PARTS

- For ALL RYKO® machines

\$299.91 RY170



SINGLE EYE MOUNT
RYKO REPLACEMENT PARTS

- Two used on each brush air cylinder

\$38.33 RY110



DOUBLE EYE MOUNT
RYKO REPLACEMENT PARTS

- Bolts to rear end of brushair cylinder

\$32.06 RY115



ROD CLEVIS PIN
RYKO REPLACEMENT PARTS

- Stainless steel pin used to connect both bolt ends of brush air cylinder to mounts.

\$7.61 RY120



ROD CLEVIS
RYKO REPLACEMENT PARTS

- Used on all brushes EXCEPT wheel scrubbers

\$50.57 RY105



REPLACEMENT DUAL ROLLER ASSEMBLY
RYKO REPLACEMENT PARTS

- For VT2000 and Rocket conveyors built AFTER 2002
- Yellow and black
- UHMW polyethylene
- Dual assembly style

\$131.90 VTR320



TUNNEL LAVA KIT
RYKO REPLACEMENT PARTS

- The Ryko FOAM12 Lava Lather kit creates a visually stunning display in your automatic tunnel! This complete kit works with your existing Ryko Softgloss XS, Maxx, or Voyager II system to give the appearance of a hot sheet of lava coming down to wax and shine your customers' cars.

THE LAVA LATHER KIT INCLUDES:

- 70" stainless steel lava unit
- Dosatron pump panel
- 40" multicolored LED light bar
- All required installation materials

\$4,014.84 FOAM12

SONNY'S® CONVEYOR CONTROL SYSTEMS

PHOTO EYES



PANTRON 24VAC & 115VAC PHOTO EYE KIT WITHOUT STANDS

SONNY'S PARTS

\$329.83	PPSK0015-24	24VAC
\$329.83	PPSK0015-115	115VAC



PANTRON ISG-A124 SERIES AUTOMATIC TEST AMPLIFIERS

SONNY'S PARTS

\$172.07	PPSA0124-24	24VAC
\$172.07	PPSA0124-115	115VAC



PPSR1005

PANTRON M12 SERIES TRANSMITTERS & RECEIVERS

SONNY'S PARTS

- Nickel plated brass

PRICE	PART #	TYPE	DESC.
\$107.07	PPSR1005	Receiver	49 ft Cable
\$71.28	PPST1005	Transmitter	49 ft Cable
\$150.51	PPSR1010	Receiver	114 ft Cable
\$58.02	PPSR1015	Receiver	M12 Connector
\$53.09	PPST1015-HP	High Powered Transmitter	M12 Connector



PANTRON M12 RIGHT ANGLE FEMALE CABLE

SONNY'S PARTS

- 3 wire
- 114 ft

\$53.37	PPSC2000-35
----------------	--------------------



PPSR1015

TAPE SWITCHES



TAPESWITCH MOLDED PVC RAMPED FLOOR SWITCH 9" W x 32" L

SONNY'S PARTS

- 24 VAC or DC - 1 Amp
- Actuation Force: 15 lbs nominal
- Mounting: 4 thru holes on 3/16" steel plate

\$181.78	TSCW932R
-----------------	-----------------



TAPESWITCH MOLDED PVC REGULAR FLOOR SWITCHES 5" W x 32" L

SONNY'S PARTS

- 24 VAC or DC - 1 Amp
- Actuation Force: 15 lbs nominal
- Mounting: 4 thru holes on 3/16" steel plate
- AWG dri-run cable

PRICE	PART #	CABLE
\$131.76	TSCW532	20 ft
\$151.50	TSCW532-50	50 ft

GO® SWITCH



GO® SWITCH MAGNET-ACTUATED

SONNY'S PARTS

- Can run AC or DC - Can be wired Normally-Open (N/O) or Normally-Closed (N/C)

\$309.87	GO1100
-----------------	---------------



GO® SWITCH AMC4 - MAGNET ONLY

SONNY'S PARTS

\$37.20	GO1100-M
----------------	-----------------



GO® SWITCH ABS3 FLAT BRACKET PLATE

SONNY'S PARTS

\$44.40	GO1100-BP
----------------	------------------

BELL HOSE TIRE SWITCH



BELL SIGNAL HOSE

SONNY'S PARTS

- 3/8" hose
- .110 wall

\$1.00 / FT	H00150
--------------------	---------------



LLDPE POLY TUBING

SONNY'S PARTS

- 3/8" hose
- 120 PSI
- 100 ft

\$30.15	PT300BK-100
----------------	--------------------



#16 NORMALLY OPEN AIR SWITCH

SONNY'S PARTS

\$15.80	AS16
----------------	-------------



SONNY'S® OVER UNDER AIR TAKE-UP CONVEYORS

AIR TAKE-UP ENTRANCE PARTS



1 15/16" 2-BOLT FLANGE BEARING
SONNY'S PARTS

\$69.11 UCFT21031



12T 10 3/16" SHAFT TAKE UP SPROCKET
SONNY'S PARTS

\$86.41 SPROCK-TU12SON



1 1/4" 3 BOLT FLANGE BEARING WITH SET SCREW LOCK
SONNY'S PARTS

PRICE	KR PART #	MFG. #
\$48.30	UCFB20720	UCFB207-20

CONVEYOR ENTRANCE PARTS



PARKER LOW PRESSURE SWITCH 30-75 PSI
SONNY'S PARTS

\$121.83 PS1P1091



X458 CHAIN



CHAIN SECTIONS
SONNY'S PARTS

• Sold in 10 ft. sections - Price per 10 feet.

\$107.07 PER 10 FT. X458



BAR
SONNY'S PARTS

\$4.75 X458BAR



PIN
SONNY'S PARTS

\$2.40 X458PIN



CENTER LINK
SONNY'S PARTS

\$4.78 X458LINK



CARRIER LINK
SONNY'S PARTS

\$22.06 CLX458-M2



2 1/4" TAPERED LOCK BUSHINGS
SONNY'S PARTS

\$41.64 TLB2517-214



4-TOOTH SPROCKET FOR X4583
SONNY'S PARTS

\$139.00 SPROCKET458

LOG CHAIN



LOG CHAIN (3 1/2" PITCH)
SONNY'S PARTS

• Heat treated

\$13.99 LOGCH



2 1/4" TAPERED LOCK BUSHINGS
SONNY'S PARTS

\$41.64 TLB2517-214

SC78 CHAIN



SC78 & SC78PC (PITCH 2.609")
SONNY'S PARTS

• Riveted pin & cotter • 16 Pitch Sections

\$38.93	SC78-16	Riveted Chain
\$41.61	SC78PC-16	Pin & Cotter Chain



PIN & COTTER
SONNY'S PARTS

\$2.75 SC78P



2 1/4" TAPERED LOCK BUSHINGS
SONNY'S PARTS

\$41.64 TLB2517-214



M2 LINKS
SONNY'S PARTS

\$11.05 SC78M2



12T 10 3/16" SHAFT TAKE UP SPROCKET
SONNY'S PARTS

\$86.41 SPROCK-TU12SON



12 TOOTH SPROCKET
SONNY'S PARTS

\$122.99 SPROCKET12

SPRING TAKE-UP ENTRANCE PARTS



1 15/16" 2-BOLT FLANGE BEARING
SONNY'S PARTS

\$69.11 UCFT21031



12T 10 3/16" SHAFT TAKE UP SPROCKET
SONNY'S PARTS

\$86.41 SPROCK-TU12SON



1 1/4" 3 BOLT FLANGE BEARING WITH SET SCREW LOCK
SONNY'S PARTS

2 NEEDED

PRICE	KR PART #	MFG. #
\$48.30	UCFB20720	UCFB207-20

SONNY'S® OVER UNDER AIR OR SPRING TAKE-UP CONVEYORS

EXIT MOTOR DRIVE OPTIONS

HYDRAULIC



2 1/4" TAPERED LOCK BUSHINGS
SONNY'S PARTS

\$41.64 TLB2517-214



12-TOOTH SPROCKET
SONNY'S PARTS

\$122.99 SPROCKET12



1 1/4" 3-BOLT FLANGE BEARING WITH SET SCREW LOCK
SONNY'S PARTS

PRICE	KR PART #	MFG. #
\$48.30	UCFB20720	UCFB207-20



FOUR BOLT CENTER FLANGE GEARBOX FOR CHAR-LYNN MOTORS
SONNY'S PARTS

\$1,460.16 HECO-9010



2000 SERIES CHAR-LYNN® MOTORS
SONNY'S PARTS

PRICE	PART#	DESCRIPTION
\$617.13	CL106-1012-006	Motor, 11.9 cu"/ Rev
\$656.86	CL106-1014-006	Motor, 18.7 cu"/ Rev

ELECTRIC



2 1/4" TAPERED LOCK BUSHINGS
SONNY'S PARTS

\$41.64 TLB2517-214



12-TOOTH SPROCKET
SONNY'S PARTS

\$122.99 SPROCKET12



1 1/4" 3-BOLT FLANGE BEARING WITH SET SCREW LOCK
SONNY'S PARTS

PRICE	KR PART #	MFG. #
\$48.30	UCFB20720	UCFB207-20

2 NEEDED

OTHER



3HP/1760RPM/182TC 230/460 STERLING MOTOR
SONNY'S PARTS

\$764.50 MSE3000

New!

5 BOLT SEAL KIT
HECO PARTS

- For Model 16, Revision 8. 5 seal carrier bolts
- Use with Heco gearbox: 16CF1-05-8-A22
- (2) Buna Graphite Shaft Seal
- (1) Ductile Iron Seal Carrier Nickel Plated
- (5) Cap Screws, Stainless Steel
- (1) Seal Carrier Buna O-Ring
- (2) Ring Gear Buna O-Ring

\$120.47 SK16-8UN

New!

6 BOLT SEAL KIT
HECO PARTS

- For Model 16, Revision 7 and all prior revisions. 6 seal carrier bolts
- Use with Heco gearbox: 16CF1-05-7-A22
- (2) Buna Graphite Shaft Seal
- (1) Ductile Iron Seal Carrier Nickel Plated
- (6) Cap Screws, Stainless Steel
- (1) Seal Carrier Buna O-Ring
- (2) Ring Gear Buna O-Ring
- Alternate Item 10006837
- This Kit is for Years 2002-2017

\$120.47 SK16-7UN



SUNGEAR INPUT SHAFT ADAPTER FOR CHAR-LYNN 2000 BEARING-LESS MOTOR
SONNY'S PARTS

\$180.29 HECO-7276

SONNY'S® SURFACE CONVEYOR | OVER UNDER SHALLOW PIT CONVEYOR

CONVEYOR PARTS



LOG CHAIN (3 1/2" PITCH)
SONNY'S PARTS

- Heat treated

\$13.99 LOGCH



2 1/4" TAPERED LOCK BUSHINGS
SONNY'S PARTS

\$41.64 TLB2517-214



3/8" F X F BRASS HIGH PRESSURE CHECK VALVE
SONNY'S PARTS

- Maximum 2000 PSI • 8 GPM

\$47.09 CV0043



2000 SERIES CHAR-LYNN® MOTOR
SONNY'S PARTS

PRICE	PART#
\$656.86	CL106-1014-006

Motor, 18.7 cu"/ Rev



90° ELBOW 1/4" NPTM x 3/8" TUBE KQ2 ONE-TOUCH FITTINGS - PACK OF 10
SONNY'S PARTS

PRICE	KR #	SMC #
\$26.74	FME-0406	KQ2L11-35AS



SUNGEAR INPUT SHAFT ADAPTER FOR CHAR-LYNN 2000 BEARING-LESS MOTOR
SONNY'S PARTS

\$180.29 HECO-7276

SONNY'S® PRESOAK APPLICATORS

FOAMING

EASY CLEAN FOAMER PARTS



1/4" K-15 PVC FLOODJET NOZZLE
SONNY'S PARTS

\$16.73 SNFJ04K15PVC



90° ELBOW 1/2" NPTM x 1/2" TUBE KQ2 ONE-TOUCH FITTINGS - PACK OF 10
SONNY'S PARTS

PRICE	KR #	SMC #
\$38.64	FME-0808	KQ2L13-37AS

California WARNING PROPOSITION 65

STANDARD FOAMER PARTS



1 5/8" I.D. STAINLESS STEEL CUSH-A-CLAMP
SONNY'S PARTS

\$34.49 CL026NS030 California WARNING PROPOSITION 65

SONNY'S® CTA TIRE & WHEEL APPLICATORS

NON-FOAMING & FOAMING

NON-FOAMING CTAS



1/4" NPT(M) 125 PSI CHECK VALVE
SONNY'S PARTS

\$7.27 SN836014NYBL



1/2" I.D. STAINLESS STEEL CUSH-A-CLAMP
SONNY'S PARTS

\$20.69 CLS14NS018

California WARNING PROPOSITION 65

FOAMING CTAS



1 3/8" I.D. STAINLESS STEEL CUSH-A-CLAMP
SONNY'S PARTS

\$29.86 CLS22NS026

California WARNING PROPOSITION 65

SONNY'S® PRESSURE GUN UNITS

DIRECT DRIVE & BELT DRIVEN UNITS

DIRECT DRIVE PUMPS



ARIMITSU 510 LEFT SHAFT PUMP
SONNY'S PARTS

- 28 mm
- 1800 RPM
- 7.5 GPM
- 1200 PSI

\$945.14 ARM510L



CAT PUMPS 7CP6170 BRASS MANIFOLD BELT DRIVE PLUNGER PUMP
SONNY'S PARTS

- 11 GPM
- 1450 RPM
- 24 mm shaft
- 2000 PSI

\$1,725.44 PU7CP6170



CAT PUMPS RAIL ASSEMBLY
SONNY'S PARTS

\$46.57 PU30613

PULSATION DAMPENER
SONNY'S PARTS

- 10 GPM
- 1/2" MNPT

\$117.18 PDK103

BELT DRIVEN PUMPS - WANNER



D10-X HYDRA-CELL PUMP
SONNY'S PARTS

- **MAX FLOW:** .1 GPM
- **MAX TEMP:** 250°F
- **INLET:** 1" NPT
- **WEIGHT:** 48 lbs.
- **SHAFT DIAMETER:** 7/8"
- **SHAFT ROTATION:** Bi-directional
- **MAX PSI:** 1000
- **MAX RPM:** 1450
- **OUTLET:** 3/4" NPT

\$1,527.50 D10XKBTHFECA



REGULATOR
SONNY'S PARTS

- **MAX FLOW:** 3-10 GPM
- **MAX PSI:** 500-1000
- **MAX TEMP:** 200°F
- **INLET:** 3/4"
- **OUTLET:** F3/4"

\$260.65 WPC22ABBNSSEF

SONNY'S® PRESSURE GUN UNITS - CONTINUED

DIRECT DRIVE & BELT DRIVEN UNITS - CONTINUED

BELT DRIVEN PUMPS - ARIMITSU



**ARIMITSU 508
LEFT SHAFT PUMP**
SONNY'S PARTS

- 9-3/4" double groove pulley
- 8 GPM @ 950 RPM, 0 - 1200 PSI
- 10 GPM @ 1200 RPM, 0 - 1000 PSI

\$1,082.23	ARM61004	PUMP SET
\$886.69	ARM508L	PUMP ONLY



9 3/4" 2 GROOVE SHEAVE
SONNY'S PARTS

\$116.82	ARM2MBL97
-----------------	------------------



2mm BUSHING FOR 5 SERIES
SONNY'S PARTS

\$19.76	ARMLX22A
----------------	-----------------

BELT DRIVEN PUMPS - COMMON PARTS



GIANT UNLOADER - YELLOW SPRING
SONNY'S PARTS

- **PSI:** 375 - 1400
- **INLET:** 1/2" FPT
- **BYPASS:** 1/2" FPT
- **FLOW:** 2.2 - 13.0 GPM
- **MATERIALS:** Stainless steel wetted
- **USE:** CAT & Arimitsu pumps
- **MAX. TEMP.:** 160°F
- **OUTLET:** 1/2" FPT
- **ACCESSORY PORTS:** 4 x 1/4"
- **HOUSING:** Bronze

\$98.50	PU22911
----------------	----------------



**45" PITCH
48" O.D. V-BELT**
SONNY'S PARTS

\$14.11	BLOB45
----------------	---------------

PRESSURE GUN STATION PARTS



**40 GALLON RECTANGULAR
STORAGE TANK**
SONNY'S PARTS

\$581.56	SOT0040	TANK
\$124.62	SOT0040LID	LID



**9 GPM HYDROMINDER
WITH SIPHON BEAKER &
MOUNTING BRACKET**
SONNY'S PARTS

\$319.14	IN530
-----------------	--------------



**1/4" LIQUID FILLED
BOTTOM MOUNT
PRESSURE GAUGE**
SONNY'S PARTS

- 0 - 2000 PSI

\$14.11	GAL2000B
----------------	-----------------

SPRAY GUN & HOSE ASSEMBLY PARTS



**MV925 NON-WEEP GUN &
GUN WITH LANCE EXTENSION**
SONNY'S PARTS

- **MAX FLOW:** 8.0 GPM
- **MAX TEMP.:** 320°F
- **OUTLET:** 1/4" FPT
- **MAX PSI:** 4500
- **INLET:** 3/8" FPT

PRICE	PART #	DESCRIPTION
\$20.88	MV925	Gun Only
\$31.33	MV925-MV70	Gun with 14" Lance Extension

**1/4" MPT CHROME PLATED
WANDS WITH MOLDED GRIP**
SONNY'S PARTS

PRICE	PART #	LENGTH
\$6.08	WTZ418MMWL	18"
\$7.18	WTZ424MMWL	24"

**3/8" x 20'
HOSE ASSEMBLY**
SONNY'S PARTS

\$37.95	HA206WBK1414
----------------	---------------------



**1/4" NOZZLE
PROTECTOR**
SONNY'S PARTS

\$3.08	NP114
---------------	--------------



**SA 1/4" MEG-2507
WASH JET NOZZLE**
SONNY'S PARTS

- 3 GPM • 25° spray angle

\$5.51	SN2507M4
---------------	-----------------



**3/8" FPT QUICK
CONNECT SOCKET**
SONNY'S PARTS

- Stainless steel

\$8.91	HF0375
---------------	---------------



**3/8" MPT QUICK
CONNECT PLUG**
SONNY'S PARTS

- Stainless steel

\$8.91	HF0376
---------------	---------------

PRESSURE GUN WAND HOLDERS



FLOOR MOUNT STAINLESS STEEL FLEXIBLE WAND HOLDER
SONNY'S PARTS

\$62.75	KRV1216
----------------	----------------

SONNY'S® TBG200 TIRE & WHEEL BRUSHES

POODLE PLUS, BISON, NINJA

TBG200 HYDRAULIC



AMI BEARING 2-BOLT WITH CAP 1 1/4"
SONNY'S PARTS

\$48.65 UCPA20720



1 1/4" 5-BOLT TIRE BRUSH SPINDLE
SONNY'S PARTS

\$94.12 UBA42016



1" x 1" SPLIT ALUMINUM COUPLERS
SONNY'S PARTS

\$12.99 AC1



TE SERIES 887 RPM PARKER HYDRAULIC TORQUE MOTOR™
SONNY'S PARTS

\$525.99 PM1250



TC SERIES 688 RPM PARKER HYDRAULIC MOTOR
SONNY'S PARTS

\$449.50 PM1225

POODLE BRUSH PLUS - HYDRAULIC & ELECTRIC



96" BOLT ADAPTER POODLE PLUS BRUSH WITH SPINDLES
SONNY'S PARTS

PRICE	PART #	COLOR
\$1,051.74	UB500BK	Black
\$1,051.74	UB500BL	Blue
\$1,051.74	UB500R	Red

WE ARE ALWAYS EXPANDING OUR REPLACEMENT PART INVENTORY!

Visit our website for the most up-to-date listings of Sonny's® replacement parts!

SONNY'S® TOP BRUSH

DUAL COUNTER WEIGHT



1 15/16" 2-BOLT FLANGE BEARING
SONNY'S PARTS

\$69.11 UCFT21031



1 1/2" 2-BOLT FLANGE BEARING
SONNY'S PARTS

\$50.95 RY245



1 1/2" 4-BOLT FLANGE BEARING
SONNY'S PARTS

\$50.96 UCF20824



DIAPHRAGM CHECK VALVE
SONNY'S PARTS

- 1/4" MPT

\$6.01 SNQJ8360NYBLQR

3 NEEDED 4240N-B020 REPLACEMENT

SONNY'S® TOP BRUSH 2K14

BRUSH ARM - COMMON PARTS



1 1/2" 2-BOLT FLANGE BEARING
SONNY'S PARTS

\$50.95 RY245



1 1/2" 4-BOLT FLANGE BEARING
SONNY'S PARTS

\$50.96 UCF20824



DIAPHRAGM CHECK VALVE
SONNY'S PARTS

- 1/4" MPT

\$6.01 SNQJ8360NYBLQR

3 NEEDED 4240N-B020 REPLACEMENT

SONNY'S® TOP BRUSH 2K14 - CONTINUED

MOTOR DRIVE OPTIONS

HYDRAULIC



TE SERIES 292 RPM PARKER HYDRAULIC TORQMOTOR™

SONNY'S PARTS

\$622.99 PM1255

WINSMITH



1½ HP/1800RPM/56C - 230/460 STERLING MOTOR

SONNY'S PARTS

\$494.99 MSE3010

SONNY'S® FRONT-TO-BACK MITTER

SFM901 HALF-MOON BASKET



NO FLANGE TAPER LOCK BUSHING - 1½"

SONNY'S PARTS

\$34.22 TLB2012-112

SONNY'S® SF TOP MOTOR SIDE WASHERS

SF50, SF63, SF1

SF50 & SF63



TE SERIES 292 RPM PARKER HYDRAULIC TORQMOTOR™

SONNY'S PARTS

\$622.99 PM1255

SF1 SINGLE & DUAL



TE SERIES 582 RPM PARKER HYDRAULIC TORQMOTOR™

SONNY'S PARTS

\$515.50 PM1200

SONNY'S® SF BOTTOM MOTOR SIDE WASHERS

SFB18, SFB21, SFB28, SFB35, SFB50, SFB63, SFBTBG18

SFB35 & COMMON PARTS



TE SERIES 292 RPM PARKER HYDRAULIC TORQMOTOR™

SONNY'S PARTS

\$622.99 PM1255

TBG18 ROCKER PANEL WASHER



TE SERIES 887 RPM PARKER HYDRAULIC TORQMOTOR™

SONNY'S PARTS

\$525.99 PM1250

SONNY'S® SF50 FRONT GRILL BRUSH

LIGHT TOUCH GRILL BRUSH



TE SERIES 582 RPM PARKER HYDRAULIC TORQMOTOR™

SONNY'S PARTS

\$515.50 PM1200



90° ELBOW ¼" NPTM x ⅜" TUBE KQ2 ONE-TOUCH FITTINGS - PACK OF 10

SONNY'S PARTS

PRICE	KR #	SMC #
\$26.74	FME-0406	KQ2L11-35AS



SEALED BRANCH TEE FITTINGS- ¼" NPTM x ⅜" TUBE KQ2 ONE-TOUCH FITTINGS - PACK OF 10

SONNY'S PARTS

PRICE	KR #	SMC #
\$39.15	FMT-0406	KQ2T11-35AS



NOT INTENDED FOR POTABLE WATER SYSTEMS

SONNY'S® WRAP-AROUND WASHERS

SF68 STRAIGHT ARMS & SF72 DOUBLE JOG ARMS

SF68 & SF72 WRAP-AROUND COMMON PARTS

HYDRAULIC DRIVE PARTS



TE SERIES 292 RPM PARKER HYDRAULIC TORQMOTOR™
SONNY'S PARTS

\$622.99 PM1255



90° ELBOW 1/4" NPTM x 3/8" TUBE KQ2 ONE-TOUCH FITTINGS - PACK OF 10
SONNY'S PARTS

PRICE	KR #	SMC #
\$26.74	FME-0406	KQ2L11-35AS

California WARNING PROPOSITION 65

SONNY'S® OMNI WASH ARCHES

TOP, SIDE & WHEEL BLASTERS

SONNY'S® DOUBLE AND TRIPLE APPLICATORS

DRIP STYLE FOAMERS

HYDRAULIC OMNI BLASTER, SINGLE MANIFOLD

DOUBLE & TRIPLE DRIP



TE SERIES 582 RPM PARKER HYDRAULIC TORQMOTOR™
SONNY'S PARTS

\$515.50 PM1200



1 5/8" I.D. STAINLESS STEEL CUSH-A-CLAMP
SONNY'S PARTS

\$34.49 CL026NS030 California WARNING PROPOSITION 65

SONNY'S® TIRE DRESSING CONTROL PANEL

24V OR 110V



5GPM FLOJET AIR PUMP 1/2" VITON, QUICK CONNECT
SONNY'S PARTS

\$185.33 FP573145 California WARNING PROPOSITION 65



FLOJET 1/2" POLYTUBE FITTING
SONNY'S PARTS

\$24.89 FPK08PT



MOUNTING BRACKET
SONNY'S PARTS

\$16.16 FPK209821 California WARNING PROPOSITION 65

SOLENOID VALVES

SONNY'S PLC



200 SERIES 3-WAY 1/4" NPTF MAC POPPET VALVE
SONNY'S PARTS

\$65.38 MAC2090 24V
\$65.37 MAC2060 120V



1/4" - 4-WAY MAC VALVE
SONNY'S PARTS

\$88.78 MAC2230 24V
\$88.78 MAC2160 120V



SMC 1/4" NPT REGULATOR 0 - 145 PSI
SONNY'S PARTS

• TEMP.: 23° to 140°F (with no freezing)

PRICE	PART #	MFG. PART #
\$32.43	SMC110	AW20-N02E-Z-B

California WARNING PROPOSITION 65

SONNY'S® TIRE SEAL MACHINES

TIRE DRESSING ROTATIONAL BRUSH

TIRE SEAL HYDRAULIC



TE SERIES 887 RPM PARKER HYDRAULIC TORQMOTOR™
SONNY'S PARTS

\$525.99 PM1250



TC SERIES 688 RPM PARKER HYDRAULIC MOTOR
SONNY'S PARTS

\$449.50 PM1225

SONNY'S® AIR DRYING MACHINES

BLOWER PRODUCERS

BLOWER MOTORS 10HP, 15HP, AND MOTOR MOUNT



3 PHASE BALDOR MOTOR 10 HP/3490 RPM/215TC
SONNY'S PARTS

\$2,020.93 MBCEM3711T

SONNY'S® BUFF-N-DRY TOP BRUSH

DUAL COUNTER WEIGHT



1½" 2 BOLT FLANGE BEARING
SONNY'S PARTS

\$50.95 RY245

FOR MORE REPLACEMENT BEARINGS
SEE THE BEGINNING OF THE
AUTOMATICS & TUNNELS SECTION!

SONNY'S® WIPE-O-MATIC

DRYING MACHINE

TIRE SHINE RETRACT ARM



24V - 1/4" - 4 WAY MAC VALVE
SONNY'S PARTS

\$88.78 MAC2230

PIVOTING AND CURTAIN TOP RETRACT ARMS



120VAC - 1/4" - 4 WAY MAC VALVE
SONNY'S PARTS

\$88.78 MAC2160

SONNY'S® HYDRAULIC POWER PACK PARTS

HYDRAULIC POWER PACK MOTORS



BALDOR 3HP MOTOR FOR POWER PACK
SONNY'S PARTS

\$981.36 MBEHPM3615T



BALDOR 5HP MOTOR FOR POWER PACK
SONNY'S PARTS

\$1,365.39 MBEHPM3710T

SONNY'S® ROLLER REPLACEMENT PARTS



IDLER WHEEL
SONNY'S PARTS

• 2¼" D x 2¾" L x 7/8" B **2 REQUIRED**

\$4.73	21/4IW	Red
\$4.57	21/4IWY	Yellow
\$7.27	21/4IWB	Blue



IDLER WHEEL
SONNY'S PARTS

• 2½" D x 2¾" L x 7/8" B **2 REQUIRED**

\$6.28	23/4IW	Red
\$6.05	23/4IWY	Yellow
\$6.26	23/4IWB	Blue



IDLER WHEEL
SONNY'S PARTS **2 REQUIRED**

• 2¼" D x 1½" L

\$1.73 21/4118IW



½" x ¾" HEX BOLT
SONNY'S PARTS

\$0.37 13203



STEEL WASHERS
SONNY'S PARTS **2 REQUIRED**

\$0.13	0133012	1/2"
\$0.18	33094	7/8"

FOR SONNY'S® 4 WHEEL & 6 WHEEL ROLLERS



PUSHER WHEEL
SONNY'S PARTS

• 3" D x 3¾" L x 1" B

\$9.46	MPTP3	Red
\$9.92	MPTP3Y	Yellow

FOR SONNY'S® LOW, TALL & MID PROFILE ROLLERS



PUSHER WHEEL
SONNY'S PARTS

• 2¼" D x 4" L x 1" B

\$8.73	MPTP214	Red
\$9.92	MPTP214Y	Yellow

BELANGER® REPLACEMENT PARTS

DURATRANS



ROLLER ASSEMBLY BELANGER PARTS

• Polyurethane outriggers are durable and easy to replace. Attach with the appropriate chain links, sold separately.

\$93.30 BC126

CONVEYOR - DURATRANS XD®



PARKER TE SERIES HYDRAULIC MOTORS BELANGER PARTS

- Ideal for over-under conveyor
- Corrosion-resistant black paint
- Use with Sungear
- 2 bolt mount
- Please confirm length measurement to ensure motor is the correct size for your equip.

\$637.44 PM1245 7-5/16" **\$705.10** PM1230 6-13/16"



1 15/16" 2-BOLT FLANGE BEARING BELANGER PARTS

\$69.11 UCFT21031

CONVEYOR - DURATRANS XD® & TOP TRACK PRO



CHAIN SECTIONS BELANGER PARTS

• Sold in 10 ft. sections - Price is per 10 feet

\$107.07 PER 10 FT. X458



BAR BELANGER PARTS

\$4.75 X458BAR



PIN BELANGER PARTS

\$2.40 X458PIN



CENTER LINK BELANGER PARTS

\$4.78 X458LINK



SEALMASTER RFB200C HEAVY DUTY 4 BOLT FLANGE BELANGER PARTS

\$475.94 UCF10000

CONVEYOR - TOP TRACK PRO/DRYER PARTS



C188 (PITCH 2.609") BELANGER PARTS

- Sold in 10 ft. sections
- Pin & Cotter
- Chain Cottered
- Same Side Steel Cotters

\$77.50 PER 10 FT. C188-10



BLOCK LINK BELANGER PARTS

\$4.11 C188BLOCK



3/8-16" NUT BELANGER PARTS

\$0.16 AC1-NUT



7/8" RIGHT OR LEFT LINK BELANGER PARTS

\$4.58 TRIPL



C188 PIN & COTTER BELANGER PARTS

\$2.07 188P

BALDOR MOTORS BELANGER PARTS

- Pressure cast aluminum end plates with ribbed design for rigidity
- Ball bearings
- Locked drive end bearing
- Heavy gauge steel frame

PRICE	PART #	HP	PHASE	RPM
\$2,780.47	MBCEM3713T	15	3	3500
\$2,020.93	MBCEM3711T	10	3	3490

FRONT-TO-BACK MITTER PARTS



BALDOR WASH DOWN MOTOR BELANGER PARTS

- Steel 230/460V wash down motor
- Max operating temp.: 104°F
- Sealed pulley end bearings
- Reversible shaft rotation

PRICE	PART #	HP	PHASE	RPM
\$1,462.08	MBEWD3558T	2	3	1800



ROD END BEARING 3/4" MALE BELANGER PARTS

\$25.14 VM12G



NO FLANGE TAPER LOCK BUSHING - 1 1/2" BELANGER PARTS

\$34.22 TLB2012-112

BELANGER® REPLACEMENT PARTS

SIDE & WRAP AROUND BRUSH PARTS



TB MOTORS

PARKER ROSS MOTORS



- Fully interchangeable with industry standards for porting, standard shafts & mountings
- Zero-leak commutation valve provides greater, more consistent, volumetric efficiency
- Full-flow lubrication maximizes cooling & extends motor life up to 50%
- Unique high-pressure shaft seal - eliminates need for case drains

PRICE	PART #	PARKER NUMBER	DISPLACEMENT	RPM	SHAFT	PORTS	MOUNT
\$348.99	PM1175	TB0100FP100AAAC	6.0 cu"/rev	454	1"	1/2" NPTF	4 Bolt
\$388.50	PM1115	TB0195FP100AAAC	11.9 cu"/rev	287	1"	1/2" NPTF	4 Bolt
\$294.99	PM1275*	TB0165FP100AAAC	163 cubic cm	343	1"	1/2" NPTF	4 Bolt

HUBS/SWIVEL/TURBO ARMS



MOSMATIC
3/8" SWIVEL WITH
BULKHEAD FITTING
BELANGER PARTS

CALL SWM33163



MOSMATIC TURBO ARM
4-NOZZLE 20"/14"
BELANGER PARTS

CALL SWMTA86843



DEMA 202B 3/8"
INJECTOR
BELANGER PARTS

- Brass
- Ryton screw metering knob
- .73 - 5.7 GPM
- Max. Induction: 8 oz/min

\$62.02 IN202B



DEMA 204B 1/2"
ADJUSTABLE INJECTOR
BELANGER PARTS

- Brass
- Screw adjustable
- 5.7 - 19 GPM
- Max. Induction: 36 oz/min

\$67.32 IN204B



DEMA 206B 3/4"
ADJUSTABLE INJECTOR
BELANGER PARTS

- Brass
- Screw adjustable
- 11 - 39 GPM
- Max. Induction: 42 oz/min

\$84.31 IN206B



TIRE BRUSH REPLACEMENT



STAINLESS STEEL
TRIGGER GUN
BELANGER PARTS

- INLET: 1/4" FPT
- MAX PSI: 150

\$139.93 GUSS3604-SS Trigger Gun
\$13.28 GUSS3604K Repair Kit



1" ALUMINUM
COUPLERS
BELANGER PARTS

\$12.99 AC1



PARKER TB SERIES MOTOR
BELANGER PARTS

- Displacement: 3.0" 3/rev
- RPM: 678 • Shaft: 1"
- Ports: 1/2" NPTF • Mount: 4 Bolt

PRICE **PART #** **PARKER NUMBER**
\$335.50 **PM1150** TB0050FP100AAAC



4 BOLT SPINDLE
BELANGER PARTS

- 4 1/2" long
- 1 1/4" shaft down to 1" with key

\$94.12 UBA42016



96" STANDARD
TIRE BRUSH
(NYLON/POLY MIX)
BELANGER PARTS

- Black
- Shaft: Bolt Adapter

\$977.82 UB504BK

VALVES/SHOCK/OIL RESERVOIR



IN-LINE COMPOSITE
FLOW CONTROL VALVE
BELANGER PARTS

- MAX TEMP.: 200°F
- MAX PSI: 200

PRICE **PART #** **NPTF**
\$27.44 **104104-F02** 1/4"
\$37.99 **104104-F03** 3/8"



NORMALLY CLOSED 2-WAY
SOLENOID VALVE
BELANGER PARTS

- ORIFICE: 1/8" • FLOW FACTOR: .28
- WATTS: 10 (AC) • CONDUIT: 1/2"
- LEADS: 18" • Stainless Steel

\$125.21 SOP1090 110/50-120/60V
\$111.77 SOP1050 24/60V



1/4" MAC VALVE NPS
BELANGER PARTS

\$88.78 **MAC2160** 120V
\$88.78 **MAC2230** 24V
\$14.80 **MAC1001** 24V Replacement Coil
\$14.80 **MAC1002** 120V Replacement Coil



CONDUIT COIL
BELANGER PARTS

- 10 Watts (AC)
- 1/2" NPT conduit
- Class F

\$55.59 SOPC500 24V AC
\$55.60 SOPC505 110V



1/4" 3-WAY
SOLENOID
BELANGER PARTS

- 24 VAC
- 1/2" NPT Conduit
- Rotates 360° for easy installation

SOP1135
\$165.13

BELANGER® REPLACEMENT PARTS

CHECK VALVES & NOZZLES



1/4" CHECK VALVE
BELANGER PARTS

• Max PSI: 125 • 1/4" NPT (M)

\$7.27 SN836014NYBL



VITON DIAPHRAGM
BELANGER PARTS

\$1.46 SNCP21953VI



1/4" FPT QUICK ADAPT CAP
BELANGER PARTS

\$0.86 HYPCAP0103



EPDM RUBBER WASHER GASKET FOR CAP 10-20 ADAPTER CAP
BELANGER PARTS

\$1.24 HYP221164



DIAPHRAGM CHECK VALVE
BELANGER PARTS

• 1/4" MPT

\$6.01 SNQJ8360NYBLQR

4240N-B020 REPLACEMENT



1/2" x 1/4" - SPLIT EYELET BODY
BELANGER PARTS

\$6.22 SE75210804



1/4" M TEEJET - BRASS BODY
BELANGER PARTS

\$2.32 SNCP1322



TEEJET STRAINER WITH CHECK VALVE
BELANGER PARTS

• Polypropylene - 50 mesh

\$3.23 SNTJ4193PP550



BRASS TEEJET TIP RETAINER
BELANGER PARTS

\$1.36 SNCP1325



BRASS UNIJET 25° SPRAY TIPS
BELANGER PARTS

PRICE	PART #	ORIFICE
\$2.76	SNTP2504	.050
\$2.76	SNTP2505	.056
\$2.76	SNTP2507	.067



BRASS UNIJET 40° SPRAY TIP
BELANGER PARTS

PRICE	PART #	ORIFICE
\$2.76	SNTP4040	.156



UNIJET CONE SPRAY TIPS
BELANGER PARTS

PRICE	PART #	ORIFICE
\$4.26	SNCJTX10	.060
\$4.26	SNCJTX5	.044

NOZZLE BUNDLES



GENERAL PUMP BELANGER VECTOR NOZZLE BUNDLE
KLEEN-RITE KITS

- FOR AUTOMATIC CAR WASH SYSTEMS
- (16) 915040M General 1504 Spray Tip 1/4"
- (4) 940060M General 4006 Spray Tip 1/4"
- (10) 925040M General 2504 Spray Tip 1/4"
- (2) 940040M General 4004 Spray Tip 1/4"

\$94.03 KRK5100

BELANGER® REPLACEMENT PARTS

VECTOR RAPID WASH™



CAT PUMPS® 3535 SERIES CERAMIC PLUNGER PUMP BELANGER PARTS

- **FLOW:** 36 GPM
- **PRESSURE:** 100 - 1,200 PSI
- **RPM:** 800 RPM
- **HP:** 29.7

\$4,660.68 PU03535



CAT PUMPS® 3535 SERIES KITS & OIL BELANGER PARTS

PART #	DESCRIPTION	KITS NEEDED
PU34235	Valve Kit	x 2
PU31040	Seal Kit	x 1
PU92674	Pump Rails	-
Factory Sized	Pump Pulley	-
PU06100	21 oz. bottle	
PU06105	2.5 gallons	

6018 ACCUMULATOR CAT PUMPS® PULSATION DAMPENER BELANGER PARTS

- **FLOW:** 40 GPM
- **TEMP:** Up to 180°F
- Rechargeable
- Replaces the 6010
- **PRESSURE:** 3000 PSI
- **PORT SIZE:** 1" NPTM

\$358.75 PU6018



1/4" SPRAY TIPS BELANGER PARTS

PRICE	PART #	TYPE
\$3.79	GNP1504M4	1504
\$3.79	GNP4006M4	4006
\$3.79	GNP4004M4	4004
\$3.79	GNP2504M4	2504

ROLLER REPLACEMENT PARTS



IDLER WHEEL BELANGER PARTS

- 2 1/4" D x 2 1/4" L x 7/8" B **2 REQUIRED**

\$4.73	21/4IW	Red
\$4.57	21/4IWY	Yellow
\$7.27	21/4IWB	Blue



IDLER WHEEL BELANGER PARTS **2 REQUIRED**

- 2 1/2" D x 2 3/4" L x 7/8" B

\$6.28	23/4IW	Red
\$6.05	23/4IWY	Yellow
\$6.26	23/4IWB	Blue



IDLER WHEEL BELANGER PARTS

- 2 1/4" D x 1 1/8" L **2 REQUIRED**

\$1.73 21/4118IW



1/2" x 3/4" HEX BOLT BELANGER PARTS

\$0.37 13203



STEEL WASHERS BELANGER PARTS

\$0.18 33094 7/8"



REPLACEMENT ROLLER BELANGER REPLACEMENT PARTS

- Welded shaft

\$55.23	B6WL214	2 1/4"	Red
\$55.98	B6WL214B	2 1/4"	Blue
\$58.60	B6WL234	2 3/4"	Red
\$59.00	B6WL234B	2 3/4"	Blue
\$59.10	B6WL258	2 5/8"	Red
\$60.00	B6WL258B	2 5/8"	Blue



PUSHER WHEEL BELANGER REPLACEMENT PARTS

- 2 1/4" D x 3 3/8" L x 1" Bore **4 REQUIRED**

\$9.94	BTP318	Red
\$9.92	BTP318B	Blue



PUSHER WHEEL BELANGER REPLACEMENT PARTS

- 2 1/4" D x 3 3/4" L x 1" Bore **4 REQUIRED**

\$10.53	BTP334	Red
\$9.92	BTP334B	Blue



IDLER WHEEL BELANGER REPLACEMENT PARTS

- 2 1/4" D x 2 5/8" L x 7/8" Bore **2 REQUIRED**

\$6.95	25/8IW	Red
\$6.78	25/8IWB	Blue

BELANGER® REPLACEMENT PARTS

SIDE WASHER

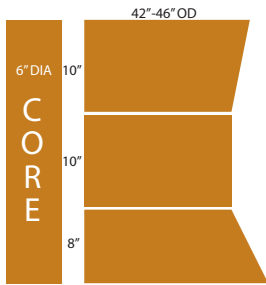

MODEL 2001 & 2x2 DRIVER SIDE 28" HIGH CORE FIVE STAR CAR WASH FOR BELANGER®

- 6" Diameter core
- 28 Channels x 28" high

CLOTH REPLACEMENT

- 28 pcs: 10" x 18"/16"
- 28 pcs: 10" x 16"
- 28 pcs: 8" x 16"/20"

CLOTH		
PRICE	PART#	COLOR
\$543.49	UBC100BL	Blue
\$543.49	UBC100BK	Black
\$543.49	UBC100R	Red
\$543.49	UBC100G	Green

FOAM		
PRICE	PART#	COLOR
\$750.42	UBF100BL	Blue
\$750.42	UBF100BK	Black
\$750.42	UBF100R	Red
\$750.42	UBF100G	Green

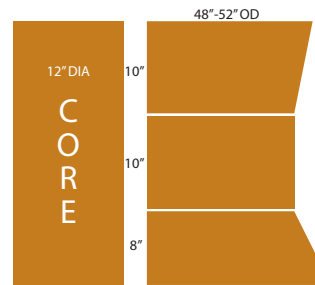

MODEL 2001 & 2x2 PASSENGER SIDE 28" HIGH CORE FIVE STAR CAR WASH FOR BELANGER®

- 12" Diameter core
- 44 Channels x 28" high

CLOTH REPLACEMENT

- 44 pcs: 10" x 18"/16"
- 44 pcs: 10" x 16"
- 44 pcs: 8" x 16"/20"

CLOTH		
PRICE	PART#	COLOR
\$855.02	UBC105BL	Blue
\$855.02	UBC105BK	Black
\$855.02	UBC105R	Red
\$855.02	UBC105G	Green

FOAM		
PRICE	PART#	COLOR
\$1,173.39	UBF105BL	Blue
\$1,173.39	UBF105BK	Black
\$1,173.39	UBF105R	Red
\$1,173.39	UBF105G	Green

MITTER

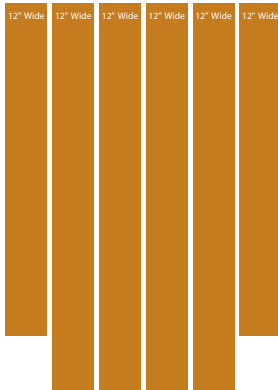

ROD STYLE

WHIPPER SNAPPER 4 BASKET CAR LENGTH CLOTH REPLACEMENT FOR BELANGER

CLOTH REPLACEMENT

- 16 pcs: 12" x 58" with 6" slit
- 16 pcs: 12" x 76" with 4" slit
- 16 pcs: 12" x 76" with 3" slit

PRICE	PART#	COLOR
\$973.27	UBCM153BL	Blue
\$973.27	UBCM153BK	Black
\$973.27	UBCM153R	Red
\$973.27	UBCM153G	Green

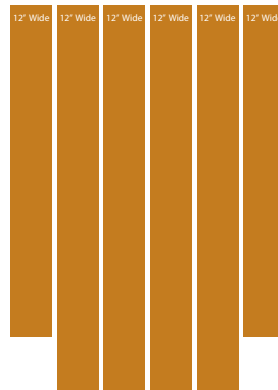

ROD STYLE

WHIPPER SNAPPER 4 BASKET VAN LENGTH CLOTH REPLACEMENT FOR BELANGER

CLOTH REPLACEMENT

- 16 pcs: 12" x 76" with 6" slit
- 16 pcs: 12" x 94" with 4" slit
- 16 pcs: 12" x 94" with 3" slit

PRICE	PART#	COLOR
\$1,107.44	UBCM113BL	Blue
\$1,107.44	UBCM113BK	Black
\$1,107.44	UBCM113R	Red

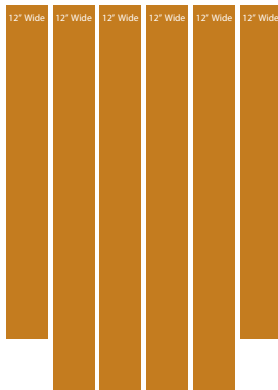

ROD STYLE

WHIPPER SNAPPER 6 BASKET VAN LENGTH CLOTH REPLACEMENT FOR BELANGER

CLOTH REPLACEMENT

- 24 pcs: 12" x 76" with 6" slit
- 24 pcs: 12" x 94" with 4" slit
- 24 pcs: 12" x 94" with 3" slit

PRICE	PART#	COLOR
\$1,660.02	UBCM103BL	Blue
\$1,660.02	UBCM103BK	Black
\$1,660.02	UBCM103R	Red
\$1,660.02	UBCM103G	Green

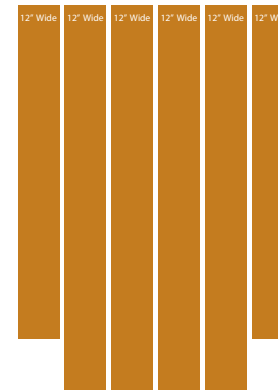

ROD STYLE

WHIPPER SNAPPER 6 BASKET CAR LENGTH CLOTH REPLACEMENT FOR BELANGER

CLOTH REPLACEMENT

- 24 pcs: 12" x 58" with 6" slit
- 24 pcs: 12" x 76" with 4" slit
- 24 pcs: 12" x 76" with 3" slit

PRICE	PART#	COLOR
\$1,432.61	UBCM143BL	Blue
\$1,432.61	UBCM143BK	Black
\$1,432.61	UBCM143G	Green

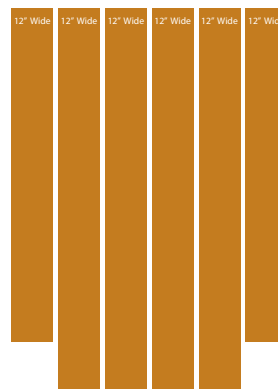

ROD STYLE

DOUBLE CROSS VAN LENGTH CLOTH REPLACEMENT FOR BELANGER

CLOTH REPLACEMENT

- 48 pcs: 12" x 78" with 3" slit

PRICE	PART#	COLOR
\$1,030.13	UBCM173BL	Blue
\$1,030.13	UBCM173BK	Black

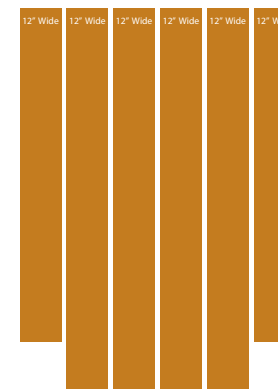

ROD STYLE

DOUBLE CROSS CAR LENGTH CLOTH REPLACEMENT FOR BELANGER

CLOTH REPLACEMENT

- 48 pcs: 12" x 60" with 3" slit

PRICE	PART#	COLOR
\$866.40	UBCM183BL	Blue
\$866.40	UBCM183BK	Black
\$866.40	UBCM183R	Red
\$866.40	UBCM183G	Green

MOTOR CITY WASH WORKS® CONVEYOR REPLACEMENT PARTS

CONVEYOR - SUPER DUTY™



ROLLER ASSEMBLY
MOTOR CITY PARTS

• Polyurethane outriggers are durable and easy to replace. Attach with the appropriate chain links, sold separately.

\$93.30 BC126

CONVEYOR - SUPER DUTY™



PARKER TE SERIES HYDRAULIC MOTORS
MOTOR CITY PARTS

• 2 bolt mount

\$637.44 PM1245 7-5/16"

CONVEYOR - WASH STREET



PARKER TE SERIES HYDRAULIC MOTORS
MOTOR CITY PARTS

• 2 bolt mount

\$637.44 PM1245 7-5/16"
\$705.10 PM1230 6-13/16"

APPLICATORS



1 3/8" I.D. STAINLESS STEEL CUSH-A-CLAMP
MOTOR CITY PARTS

\$29.86 CLS22NS026



1 5/8" I.D. STAINLESS STEEL CUSH-A-CLAMP
MOTOR CITY PARTS

\$34.49 CLO26NS030



1/4" MPT DIAPHRAGM CHECK VALVE
MOTOR CITY PARTS

\$6.01 SNQJ8360NYBLQR

4240N-B020 REPLACEMENT



1/4" FPT QUICK ADAPT CAP
MOTOR CITY PARTS

\$0.86 HYPCAP0103



EPDM RUBBER WASHER GASKET FOR CAP10-20 ADAPTER CAP
MOTOR CITY PARTS

\$1.24 HYP221164



SPRAYING SYSTEMS 1/4" FPT INLET VITON TRIGGER JET
MOTOR CITY PARTS

\$19.76 GUSS50



SPRAYING SYSTEMS SPLIT EYELET WITH CHECK VALVE
MOTOR CITY PARTS

\$3.09 SNQJ17560-8BL 1/2"
\$3.10 SNQJ17560-12BL 3/4"

5" W x 32" L REGULAR FLOOR SWITCHES
TAPESWITCH



TECHNICAL DATA:

- **VOLTAGE:** 24 VAC or DC
- **CURRENT RATING:** 1 Amp
- **ACTUATION FORCE:** 15 lbs nominal
- **MATERIAL:** Molded PVC
- **COLOR:** Gray
- **MOUNTING:** 4 thru holes on 3/16" steel plate



REGULAR FLOOR SWITCH			
PRICE	PART #	CABLE	SIZE
\$131.76	TSCW532	20 ft	5" W x 32" L
\$151.50	TSCW532-50	50 ft	5" W x 32" L

RAMPED FLOOR SWITCH		
PRICE	PART #	SIZE
\$181.78	TSCW932R	9" W x 32" L



ASCO S SERIES 1/2" NORMALLY CLOSED SOLENOID VALVE
MOTOR CITY® PARTS

\$67.99 SC200 24V
\$67.99 SC225 120V



ASCO S SERIES 3/4" NORMALLY CLOSED SOLENOID VALVE
MOTOR CITY® PARTS

\$98.39 SC300 24V
\$98.39 SC325 120V



1/4" 120V 3-WAY MAC VALVE W/ DIN
MOTOR CITY® PARTS

\$48.95 MAC2020

MOTOR CITY WASH WORKS® CONVEYOR REPLACEMENT PARTS

APPLICATORS - CONTINUED



511 HYDROMINDER - LOW VOLUME UNIT WITH SIPHON BEAKER (4.5 GPM)

MOTOR CITY PARTS

\$167.50 IN511



511 HYDROMINDER - LOW VOLUME UNIT WITH SINGLE E-GAP EDUCTOR (4.5 GPM)

MOTOR CITY PARTS

\$181.06 IN511ES



FLOJET G57 SERIES AIR-OPERATED PUMPS

MOTOR CITY PARTS

- MAX FLOW RATE: 5 GPM
- PRESSURE RATING: 20-100 PSI
- AIR CONSUMPTION: 2.1 SCFM at 100 PSI
- AIR INLET: 1/4" brass hose barb
- PRODUCT INLET: 1/2" PushLock
- PRODUCT OUTLET: 1/2" PushLock

PRICE	PART #	DIAPHRAGM
\$171.83	FP575145	SANTOPRENE
\$185.33	FP573145	VITON
\$242.01	FP57142	KALREZ



FLOJET G57 SERIES AIR-OPERATED PUMPS

MOTOR CITY PARTS

- MAX FLOW RATE: 5 GPM
- PRESSURE RATING: 20-100 PSI
- AIR INLET: 1/4" brass hose barb
- PRODUCT INLET: 1/2" hose barb
- PRODUCT OUTLET: 1/2" hose barb

PRICE	PART #	DIAPHRAGM	PORT KIT
\$104.29	FP7040	SANTOPRENE	FPK06B
\$145.98	FP7020	VITON	FPK06V



BEARINGS & BRUSHES



1" 2-BOLT FLANGE BEARING

MOTOR CITY PARTS

\$28.76 UCFT20516



CHEMICAL SUPPLIES, METERING TIPS, HYDROMINDER PARTS



CLEAR VINYL TUBE
1/4" ID x 3/8" OD

MOTOR CITY PARTS

\$0.25 HCV04T



THREADED METERING TIP KIT

MOTOR CITY PARTS

\$12.48 IN690015



PUSH IN METERING TIP KIT

MOTOR CITY PARTS

\$12.91 IN690014



3401-R 1/4" TIP ADAPTER

MOTOR CITY PARTS

\$0.79 IN3401R



GRAY EPDM FOOT VALVE

MOTOR CITY PARTS

\$9.62 IN250100



BLUE VITON FOOT VALVE

MOTOR CITY PARTS

\$13.12 IN250020



1 1/2 - 9 GPM MAGNET KIT

MOTOR CITY PARTS

\$22.30 IN10080500



6655-K VALVE KIT/LOW-MED VOL.

MOTOR CITY PARTS

\$22.89 IN6655K



511 HYDROMINDER - LOW VOLUME UNIT WITH SIPHON BEAKER (4.5 GPM)

MOTOR CITY PARTS

\$167.50 IN511



511 HYDROMINDER - LOW VOLUME UNIT WITH SINGLE E-GAP EDUCTOR (4.5 GPM)

MOTOR CITY PARTS

\$181.06 IN511ES



572 HYDROMINDER WATER FLOAT VALVE ONLY WITH MOUNTING BRACKET (44 GPM)

MOTOR CITY PARTS

\$238.99 IN572

MOTOR CITY WASH WORKS® CONVEYOR REPLACEMENT PARTS

NOZZLES



SPRAYING SYSTEMS CO.® WASHJET® IMEG® SPRAY NOZZLES
MOTOR CITY PARTS

- Spray angles of 0° to 65° - operating pressures from 300 PSI - 4000 PSI
- Longer wear life and flow control accuracy with specially hardened stainless steel

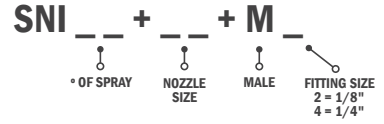

1/8" MPT MEG NOZZLES 25°			
PRICE	PART #	DESCRIPTION	GPM @ 1000PSI
\$4.35	SN2505M2	SA1/8MEG-2505	2.5
\$4.35	SN2506M2	SA1/8MEG-2506	3.0
\$4.35	SN2507M2	SA1/8MEG-2507	3.5
\$4.35	SN2508M2	SA1/8MEG-2508	4.0

1/8" MPT MEG NOZZLES 65°			
PRICE	PART #	DESCRIPTION	GPM @ 1000PSI
\$4.35	SN6505M2	SA1/8MEG-6505	2.5
\$4.35	SN6506M2	SA1/8MEG-6506	3.0
\$4.35	SN6507M2	SA1/8MEG-6507	3.5
\$4.35	SN6508M2	SA1/8MEG-6508	4.0

1/4" MPT MEG NOZZLES 5°			
PRICE	PART #	DESCRIPTION	GPM @ 1000PSI
\$4.54	SN0502M4	SA1/4MEG-0502	1.0
\$4.54	SN0503M4	SA1/4MEG-0503	1.5
\$4.54	SN0504M4	SA1/4MEG-0504	2.0
\$4.54	SN0506M4	SA1/4MEG-0506	3.0
\$4.54	SN0507M4	SA1/4MEG-0507	3.5
\$4.54	SN0509M4	SA1/4MEG-0509	4.5
\$4.54	SN0512M4	SA1/4MEG-0512	6.0
\$4.54	SN0515M4	SA1/4MEG-0515	7.5

1/4" MPT MEG NOZZLES 15°			
PRICE	PART #	DESCRIPTION	GPM @ 1000PSI
\$4.54	SN1504M4	SA1/4MEG-1504	2.0
\$4.54	SN15045M4	SA1/4MEG-15045	2.25
\$4.54	SN1505M4	SA1/4MEG-1505	2.5
\$4.54	SN15055M4	SA1/4MEG-15055	2.75
\$4.54	SN15065M4	SA1/4MEG-15065	3.25
\$4.54	SN1512M4	SA1/4MEG-1512	6.0
\$4.54	SN1520M4	SA1/4MEG-1520	10.0

1/4" MPT MEG NOZZLES 25°			
PRICE	PART #	DESCRIPTION	GPM @ 1000PSI
\$4.54	SN2502M4	SA1/4MEG-2502	1.0
\$4.54	SN2505M4	SA1/4MEG-2505	2.5
\$4.54	SN2506M4	SA1/4MEG-2506	3.0
\$4.54	SN2507M4	SA1/4MEG-2507	3.5
\$4.54	SN2508M4	SA1/4MEG-2508	4.0
\$4.54	SN2510M4	SA1/4MEG-2510	5.0

1/4" MPT MEG NOZZLES 40°			
PRICE	PART #	DESCRIPTION	GPM @ 1000PSI
\$4.54	SN4004M4	SA1/4MEG-4004	2.0
\$4.54	SN4005M4	SA1/4MEG-4005	2.5

1/4" MPT MEG NOZZLES 50°			
PRICE	PART #	DESCRIPTION	GPM @ 1000PSI
\$4.54	SN5003M4	SA1/4MEG-5003	1.5
\$4.54	SN5004M4	SA1/4MEG-5004	2.0
\$4.54	SN5006M4	SA1/4MEG-5006	3.0
\$4.54	SN5010M4	SA1/4MEG-5010	5.0

1/4" MPT MEG NOZZLES 65°			
PRICE	PART #	DESCRIPTION	GPM @ 1000PSI
\$4.54	SN6502M4	SA1/4MEG-6502	1.0
\$4.54	SN6503M4	SA1/4MEG-6503	1.5
\$4.54	SN6504M4	SA1/4MEG-6504	2.0
\$4.54	SN6505M4	SA1/4MEG-6505	2.5
\$4.54	SN6506M4	SA1/4MEG-6506	3.0
\$4.54	SN6507M4	SA1/4MEG-6507	3.5
\$4.54	SN6508M4	SA1/4MEG-6508	4.0
\$4.54	SN6510M4	SA1/4MEG-6510	5.0
\$4.54	SN6515M4	SA1/4MEG-6515	7.5
\$4.54	SN6520M4	SA1/4MEG-6520	10

1/4" MPT MEG NOZZLES WITH VANE			
PRICE	PART #	DESCRIPTION	GPM @ 1000PSI
CALL	SNV6530M4	MPT 6530 W/ VANE	15.0



1/4K-15 PVC FLOODJET NOZZLE
MOTOR CITY PARTS

\$16.73 SNFJ04K15PVC



1/4" FPT QUICK ADAPT CAP
MOTOR CITY PARTS

\$0.86 HYPCAP0103



EPDM RUBBER WASHER GASKET FOR CAP10-20 ADAPTER CAP
MOTOR CITY PARTS

\$1.24 HYP221164



1/4" M DIAPHRAGM CHECK VALVE
MOTOR CITY PARTS

\$6.01 SNQJ8360NYBLQR
4240N-B020 REPLACEMENT



SPRAYING SYSTEMS SPLIT EYELET WITH CHECK VALVE
MOTOR CITY PARTS

\$3.09 SNQJ17560-8BL 1/2"
\$3.10 SNQJ17560-12BL 3/4"



SUTTNER ST-357 TURBO NOZZLES
MOTOR CITY PARTS

- 3600 PSI
- Colored seat indicates orifice size

PRICE	ITEM #	ORIFICE
\$59.93	SUT357-3	3.0 - Yellow
\$59.93	SUT357-6	6.0 - Red
\$33.96	SUT357-3K	Repair Kit

VALVES/PUMPS



ASCO S SERIES 1/2" NORMALLY CLOSED SOLENOID VALVE
MOTOR CITY PARTS

\$67.99 SC200 24V
\$67.99 SC225 120V



ASCO S SERIES 3/4" NORMALLY CLOSED SOLENOID VALVE
MOTOR CITY PARTS

\$98.39 SC300 24V
\$98.39 SC325 120V



1/4" MAC VALVE NPS
MOTOR CITY PARTS

\$88.78 MAC2160 120V
\$88.78 MAC2230 24V



200 SERIES 3-WAY 1/4" NPTF MAC POPPET VALVE
SONNY'S PARTS

\$65.38 MAC2090 24V
\$65.37 MAC2060 120V

MOTOR CITY WASH WORKS® CONVEYOR REPLACEMENT PARTS

VALVES/PUMPS



BLUE-WHITE® C-1500N SERIES - INJECTION METERING PUMPS

MOTOR CITY PARTS

- FKM O-ring & PTFE/EP diaphragm
- PVDF suction (foot) valve with FKM and TFE/P O-rings, ceramic check ball and removable polypropylene filter screen

SPECIFICATIONS

- STROKE: .055" • MAX FLOW: 26.6 GPD • VOLTAGE: 115 • MAX PRESSURE: 125 PSI • MAX TEMP: 130°F • RPM: 45

\$411.80	BW15N202X	115V 2.4oz/min	\$415.10	BW15N341X	115V 6.4oz/min
\$411.80	BW15N331X	24V 6.4oz/min	\$411.80	BW15N432X066V	24V 3.0oz/min
\$411.80	BW15N301X066V	115V 3.1oz/min	\$411.80	BW15N404X	115V 10.6oz/min
\$411.80	BW15N302X066	115V 1.4oz/min	\$411.80	BW15N432X24V	24V 5.9oz/min
\$411.80	BW15N332X	24V 2.7oz/min	\$411.80	BW15N402X	115V 5.9oz/min
\$411.80	BW15N302X	115V 2.7oz/min	\$411.80	BW15N414X040	220V 4.8oz/min

CYLINDER, SHOCK, PUMPS



14 GPM 500:1-50:1 85 PSI DOSATRON CHEMICAL PROPORTIONER

MOTOR CITY PARTS

- The water-powered with Viton seal and O-rings, polypropylene housings and an easy-to-adjust ratio stem

\$466.24 DOSD1402



FLOJET G57 SERIES AIR-OPERATED PUMPS

MOTOR CITY PARTS

- MAX FLOW RATE: 5 GPM
- PRESSURE RATING: 20-100 PSI
- AIR INLET: 1/4" brass hose barb
- PRODUCT INLET: 1/2" hose barb
- PRODUCT OUTLET: 1/2" hose barb

PRICE	PART #	DIAPHRAGM	PORT KIT
\$104.29	FP7040	SANTOPRENE	FPK06B
\$145.98	FP7020	VITON	FPK06V



FLOJET VITON PUSH-IN POLYTUBE FITTING

MOTOR CITY PARTS

\$15.19	FPK06PT	3/8"
\$24.89	FPK08PT	1/2"



MOUNTING BRACKET

MOTOR CITY PARTS

\$16.16 FPK209821



PUMPS



D10-X HYDRA-CELL PUMP

MOTOR CITY PARTS

- MAX FLOW: 8.1 GPM • MAX PSI: 1000
- MAX TEMP: 250°F • MAX RPM: 1450
- INLET: 1" NPT • OUTLET: 3/4" NPT
- WEIGHT: 48 lbs.
- SHAFT DIAMETER: 7/8"
- SHAFT ROTATION: Bi-directional

\$1,527.50	D10XKBTHFECA	Pump
\$267.80	WPA031751101	D/G-10 Tool Kit



H-25-X HYDRA-CELL PUMP

MOTOR CITY PARTS

- MAX FLOW: 20 GPM • MAX PSI: 1000
- MAX TEMP: 250°F • MAX RPM: 1050
- INLET: 1 1/2" • OUTLET: 1" NPT
- SHAFT DIAMETER: 1 1/8"

\$3,637.93 WPH25XKBTH Pump

\$22.09	WPD030391030	Oil Fill Cap W/ O-Ring
\$140.63	WPD25D52TX	H25 Diaphragm
\$406.26	D25K52THFEC	H25 Repair Kit
\$250.01	WPA031751102	H/G-25 Fluid End
\$881.18	WPA031751107	Master Tool Kit



D35-X HYDRA-CELL PUMP

MOTOR CITY PARTS

- MAX FLOW: 37 GPM • MAX PSI: 250
- MAX TEMP: 250°F • MAX RPM: 1050
- INLET: 2 1/2" • OUTLET: 1 1/4" NPT
- SHAFT DIAMETER: 2"

\$6,333.54 WPD35XKBTH Pump

\$125.01	WPA011163400	12 oz. Oil Reservoir
\$234.39	D35D52TXXXX	Diaphragm Kit
\$316.32	WPA032001100	D/G-35 Tool Kit
\$881.18	WPA031751107	Master Tool Kit



10W30 HYDRA-CELL OIL

MOTOR CITY PARTS

- Ideal for low temperature and high load
- Maintains consistent viscosity through a wide range of temperatures

\$16.86	WPOA011143430	1 Quart
\$112.96	WPOA011143432	2 1/2 Gal

MOTOR CITY WASH WORKS® CONVEYOR REPLACEMENT PARTS

HYDRAULIC MOTORS/SELFIT HYDRAULIC HOSE KIT



PARKER TB SERIES MOTORS
MOTOR CITY PARTS

- 1/2" NPTF Ports
- 4 bolt mount
- 1" Shaft



PARKER TE SERIES MOTORS
MOTOR CITY PARTS

- 7/8"-14 SAE Ports
- 4 bolt w/ 3/8-16 UNC
- 1" Shaft



PARKER BUNA SEAL KIT
MOTOR CITY PARTS

- For TB/TC/TE series

PRICE	PART #	PARKER NUMBER	DISPLACEMENT	RPM
\$388.50	PM1115	TB0195FP100AAAC	11.9 cu"/rev	287
\$335.50	PM1150	TB0050FP100AAAC	3.0 cu"/rev	678
\$336.99	PM1155	TB0065FP100AAAC	4.0 cu"/rev	511
\$348.99	PM1175	TB0100FP100AAAC	6.0 cu"/rev	454
\$409.50	PM1195	TB0230FP100AAAC	13.9 cu"/rev	246
\$294.99	PM1275	TB0165FP100AAAC	163 cubic cm	343

New!

PRICE	PART #	PARKER NUMBER	DISPLACEMENT	RPM
\$515.50	PM1200	TE0100FS100AAAC	6.0 cu"/rev	582
\$525.99	PM1250	TE0065FS100AAAC	4.0 cu"/rev	877
\$622.99	PM1255	TE0195FS100AAAC	11.9 cu"/rev	292

\$92.74 S0PK320

ELECTRIC MOTORS & FITTINGS



1.5HP/1800RPM/56C - 230/460
STERLING MOTOR
MOTOR CITY PARTS

\$494.99 MSE3010



3 PHASE BALDOR MOTOR
10 HP/3490 RPM/ 215TC
MOTOR CITY PARTS

\$2,020.93 MBCEM3711T



Motor City Wash Works, Inc. was founded in 2004 and has grown to become a respected leader in the car wash industry. This reliable car wash company focuses on tunnel wash systems and other automatic equipment. They offer quality systems in a variety of sizes to fit different customers' applications. They also offer fleet systems for auto dealerships, vehicle rental agencies, and truck fleets. Regardless of your type of wash, Motor City will customize your system for things like performance needs, location size, and branding. Motor City Wash Works is fixated on setting the industry standard for innovation, durability, and performance.

Kleen-Rite carries an ample selection of new parts that are designed for use with Motor City Wash Works equipment. We can be your supplier for smaller parts like valves, nozzles, and rollers, as well as larger components like pumps and motors that are compatible with Motor City car wash systems. As with all of Kleen-Rite's products, you'll be sure to find the Motor City Wash Works parts you need at the most competitive prices on the market.

If you're a new owner of a Motor City Wash Works car wash system, it's crucial to select a parts supplier that you can trust to help service and maintain your equipment. Why not start off on the right foot and go with Kleen-Rite right away? If you've had a Motor City Wash Works system for years and are starting to realize that you're paying too much for your replacement parts, make the switch to Kleen-Rite and get yourself on the right track.

Browse our full listing of Motor City Wash Works replacement parts at kleen-ritecorp.com. You can also contact our sales team to discuss your needs and get advice on the parts you're going to need to keep your Motor City Wash Works system running at peak performance!

UNITEC WASH SELECT II REPLACEMENT PARTS



KEYPAD ASSEMBLY
ASTROMATIC

- FOR USE WITH: UNITEC Wash Select II

\$81.78 SA1833



PUSH BUTTON
ASTROMATIC

- FOR USE WITH: UNITEC Wash Select II

\$8.24 SA2167

HANNA™ REPLACEMENT PRODUCTS

DRIVE SPROCKETS



12 TOOTH SPROCKET
HANNA PARTS

\$122.99 SPROCKET12



2 1/4" TAPERED LOCK BUSHINGS
HANNA PARTS

\$41.64 TLB2517-214

DRUM & TAKE-UP SPROCKETS



AMI BEARING 4-BOLT FLANGE
1 15/16"
HANNA PARTS

\$69.11 UCF21031

CONVEYOR CHAINS



D88K RIVETED CHAINS - 2.609" PITCH
HANNA PARTS

\$42.12	D88K-16	16 Pitch Section
\$89.31	D88K-34	34 Pitch Section



D88K PIN & COTTER - 2.609" PITCH
HANNA PARTS

\$55.46	D88KPC-16	16 Pitch Section
\$117.29	D88KPC-34	34 Pitch Section



D88K 2 3/16" PIN & COTTER
HANNA PARTS

\$2.90 D88KDP



D88K 2 7/16" PIN & COTTER
HANNA PARTS

\$3.75 D88KDPL



STAINLESS STEEL COTTER ONLY
HANNA PARTS

\$0.30 D88KS-S



SC78 & SC78PC (PITCH 2.609")
HANNA PARTS

\$38.93	SC78-16	Riveted Chain (16 Pitch Section)
\$41.61	SC78PC-16	Pin & Cotter Chain (16 Pitch Section)



SC78 PIN & COTTER
HANNA PARTS

\$2.75 SC78P



STAINLESS STEEL COTTER ONLY
HANNA PARTS

\$0.30 D88KS-S

HYDRAULIC MOTOR & GEAR BOX



2000 SERIES CHAR-LYNN® MOTORS
HANNA PARTS

PRICE	PART#	DESCRIPTION
\$617.13	CL106-1012-006	11.9 cu"/Rev
\$638.14	CL106-1013-006	14.9 cu"/Rev
\$656.86	CL106-1014-006	18.7 cu"/Rev

BUNA SEAL KIT FOR 2000 SERIES CHAR-LYNN® MOTORS
HANNA PARTS

\$46.52 CLP61259

SURFACE CONVEYOR REPLACEMENT PARTS



LOG CHAIN (3 1/2" PITCH)
HANNA PARTS

• Heat treated

\$13.99 LOGCH



LIMIT SWITCH, SQUARE-D 4-POSITION
HANNA PARTS

\$232.66 ST0310



LIMIT SWITCH, HEAD ROTARY FOR C54B2
HANNA PARTS

\$57.15 ST0311



LIMIT SWITCH, LEVER ARM ROD FOR C54B2
HANNA PARTS

\$38.86 ST0312

CONVEYOR PARTS



1" - 2 BOLT PILLOW BLOCK WITH SET SCREW LOCK
HANNA PARTS

\$30.35 UCP20516

CONVEYOR & CYLINDER DOORS



ARO CLEVIS MOUNT CYLINDER 1 1/2" BORE x 4 1/2" STROKE
HANNA PARTS

\$147.75 AC1060

HANNA™ REPLACEMENT PRODUCTS

ROLLERS

RCV STYLE

KLEEN-RITE REPLACEMENT ROLLER FOR HANNA STYLE RCV ROLLER

HANNA PARTS

- Bolted Shaft
- 1" W x 3½" D steel wheel
- CHAIN ATTACHMENT SOLD SEPARATELY

PRICE	PART #	IDLER WHEEL
\$99.00	RCVR214	2¼" Wide
\$102.46	RCVR234	2¾" Wide

FRAME

HANNA PARTS

- Bushings **NOT INCLUDED**

CALL **RCVFRAME**

REAR AXLE CROSS

HANNA PARTS

- ⅞"

\$9.88 **RCVRA**

PUSHER WHEEL

HANNA PARTS

- 2 Required
- 3" x 3¼"

\$8.47	RCVTP	Red
\$9.84	RCVTPY	Yellow

⅝" I.D. BUSHING

HANNA PARTS

\$4.00 **RCVB**

2 NEEDED

FRONT SHAFT

HANNA PARTS

- ⅝" D x 9¾" L

\$11.00 **RCVFS**

1 NEEDED

STEEL WHEEL

REPLACEMENT PARTS

- 1" x 3½" Diameter

\$21.30 **RCVSW**

2 NEEDED

6 WHEEL LOW PROFILE STYLE

6 WHEEL LOW PROFILE ROLLER

HANNA PARTS

- Chain attachment sold separately

PRICE	PART #	IDLER WHEEL	COLOR
\$56.58	6WLPR214	2¼" W	Red
\$57.33	6WLPR214Y	2¼" W	Yellow
\$59.95	6WLPR234	2¾" W	Red
\$59.95	6WLPR234Y	2¾" W	Yellow

6 WHEEL LOW PROFILE ROLLER BOLTED SHAFT

HANNA PARTS

- Chain attachment sold separately

PRICE	PART #	IDLER WHEEL	COLOR
\$62.65	6WLPR214Y-B	2¼" W	Yellow
\$65.28	6WLPR234Y-B	2¾" W	Yellow

6 WHEEL LOW PROFILE ROLLER WITH M2 LINK

HANNA REPLACEMENT PARTS

- Chain attachment sold separately

PRICE	PART #	IDLER WHEEL	COLOR
\$56.58	6WLPR214-M2	2¼" W	Red
\$64.78	6WLPR214Y-M2	2¼" W	Yellow
\$71.65	6WLPR234-M2	2¾" W	Red
\$79.10	6WLPR234Y-M2	2¾" W	Yellow

LOW PROFILE FRAME

HANNA PARTS

\$34.89 **6WRLPF**

1 NEEDED

6 WHEEL HIGH PROFILE STYLE

6 WHEEL HIGH PROFILE ROLLER

HANNA PARTS

- Chain attachment sold separately

PRICE	PART #	IDLER WHEEL	COLOR
\$55.10	6WHPR214	2¼" W	Red
\$58.48	6WHPR234	2¾" W	Red

6 WHEEL HIGH PROFILE ROLLER WITH M2 LINK

HANNA PARTS

- Chain attachment sold separately

PRICE	PART #	IDLER WHEEL	COLOR
\$55.10	6WHPR214-M2	2¼" W	Red
\$58.48	6WHPR234-M2	2¾" W	Red

PUSHER WHEELS FOR LOW & HIGH PROFILE

PUSHER WHEEL

HANNA REPLACEMENT PARTS

- 2" D x 4" L x 1" ID

\$5.49	6WP	Red
\$4.93	6WPY	Yellow

4 NEEDED

HIGH PROFILE FRAME

HANNA PARTS

\$46.25 **6WRHPF**

1 NEEDED

HANNA™ REPLACEMENT PRODUCTS

ROLLER REPLACEMENTS PARTS



D88K LINKS
HANNA PARTS

\$9.93	D88KALL	Left
\$9.93	D88KARL	Right



D88K 2³/₁₆" PIN & COTTER
HANNA PARTS

\$2.90	D88KDP
---------------	---------------



D88K 2⁷/₁₆" PIN & COTTER
HANNA PARTS

\$3.75	D88KDPL
---------------	----------------



STAINLESS STEEL COTTER ONLY
HANNA PARTS

\$0.30	D88KS-S
---------------	----------------



D88K M2 LINK
HANNA PARTS

\$11.01	D88KM2
----------------	---------------



C188 - 7/8" RIGHT OR LEFT LINK
HANNA PARTS

\$4.58	TRIPL
---------------	--------------



C188 PIN & COTTER
HANNA PARTS

\$2.07	188P
---------------	-------------



D667K TRIANGLE PLATE
HANNA PARTS

\$2.10	D667L	Left
---------------	--------------	------

CONVEYOR CORRELATOR/COUPLERS



HYTREL PLASTIC



URETHANE PLASTIC



BUNA RUBBER

LOVEJOY SPIDERS
HANNA PARTS

PRICE	PART #	DESCRIPTION	MATERIAL	COLOR
\$27.85	FCS075H	L075/AL075	Hytre Plastic	Tan
\$37.15	FCS090H	L090/AL090, L095/AL095	Hytre Plastic	Tan
\$88.39	FCS099H	L099/AL099, L100/AL100	Hytre Plastic	Tan
\$9.48	FCS075B	L075/AL075	Buna Rubber	Black
\$12.25	FCS090B	L090/AL090, L095/AL095	Buna Rubber	Black
\$25.80	FCS099B	L099/AL099, L100/AL100	Buna Rubber	Black
\$51.25	FCS099U	L099/AL099, L100/AL100	Urethane Plastic	Blue
\$97.29	FCS110U	L110/AL110	Urethane Plastic	Blue



SPLIT



NOT SPLIT

EPDM FLEX COUPLINGS
HANNA PARTS

PRICE	PART #	STYLE
\$15.65	FC4JES	Split
\$27.37	FC5JES	Split
\$43.03	FC6JES	Split
\$54.75	FC7JES	Split
\$50.87	FC7JE	Not Split
\$74.32	FC8JES	Split



3/8-16" REPLACEMENT NUT
HANNA PARTS

\$0.16	AC1-NUT
---------------	----------------

TIRE WASHER & TIRE BRUSH PARTS



1" ALUMINUM COUPLERS
HANNA PARTS

\$12.99	AC1
----------------	------------



4¹/₂" LONG 4 BOLT SPINDLE
HANNA PARTS

- 1¹/₄" shaft down to 1" with key

\$94.12	UBA42016
----------------	-----------------



96" STANDARD TIRE BRUSHES (NYLON/POLY MIX)
HANNA PARTS

- Shaft: Bolt Adapter

PRICE	PART #	COLOR
\$977.82	UB504BK	Black
\$977.82	UB504BL	Blue
\$977.82	UB504R	Red



96" BOLT ADAPTER POODLE PLUS BRUSH WITH SPINDLES
HANNA PARTS

PRICE	PART #	COLOR
\$1,051.74	UB500BK	Black
\$1,051.74	UB500BL	Blue
\$1,051.74	UB500R	Red

TIRE BRUSH & ROCKER PARTS



1¹/₄" AMI BEARING INSERTS
HANNA PARTS

PRICE	KR PART #	MFG. PART #
\$27.43	UC20720	UC206-20

CHAR-LYNN® H SERIES MOTOR
HANNA PARTS

- **MAXIMUM CASE PRESSURE:** 1500 PSI
- **MAXIMUM TEMPERATURE:** 180°F
- **FLUID VISCOSITY:** Minimum viscosity at operating temperature should be the highest of the following: 10 SUS or (20 X PSI)/RPM=SUS

PRICE	PART#	DESCRIPTION	DISPLACEMENT	RPM/3 GPM	RPM/6 GPM	PSI
\$309.52	CL101-1001-009	Motor, 1/4" Ring	2.8	235	471	1800 continuous, 2400 intermittent
\$318.07	CL101-1002-009	Motor, 3/8" Ring	4.5	150	296	1800 continuous, 2400 intermittent
\$380.77	CL101-1004-009	Motor, 7/8" Ring	9.7	70	140	

WANT TO LEARN MORE ABOUT CHAR-LYNN® MOTORS?

Check out the featured product spotlight on page 554!

HANNA™ REPLACEMENT PRODUCTS

HYDRAULIC MOTORS

CHAR-LYNN® H SERIES MOTOR - 1/2" FPT

HANNA PARTS

- **MAXIMUM CASE PRESSURE:** 1500 PSI
- **MAXIMUM TEMPERATURE:** 180°F
- **FLUID VISCOSITY:** Minimum viscosity at operating temperature should be the highest of the following: 10 SUS or (20 X PSI)/RPM=SUS



CLP22000-2

PRICE	PART#	DESCRIPTION	DISPLACEMENT	RPM/3 GPM	RPM/6 GPM	RING SIZE
\$309.52	CL101-1001-009	Motor, 1/4" Ring	2.8	235	471	1/4"
\$318.07	CL101-1002-009	Motor, 3/8" Ring	4.5	150	296	3/8"
\$327.46	CL101-1003-009	Motor, 1/2" Ring	5.9	115	230	1/2"
\$380.77	CL101-1004-009	Motor, 7/8" Ring	9.7	70	140	7/8"
\$395.01	CL101-1005-009	Motor, 1" Ring	11.3	60	120	1"
\$389.04	CL101-1006-009	Motor, 1 1/4" Ring	14.1	48	95	1 1/4"
\$411.28	CL101-1007-009	Motor, 1 1/2" Ring	17.9	38	75	1 1/2"
\$449.74	CL101-1008-009	Motor, 2" Ring	22.6	30	60	2"
\$95.75	CLP22000-2	4 Bolt Mount Flange 009-010				
\$66.31	CLP60540	Seal Kit 009				

CHAR-LYNN® S-PLUS MOTOR - 1/2" FPT

HANNA PARTS

- **MAXIMUM CASE PRESSURE:** 1500 PSI
- **MAXIMUM TEMPERATURE:** 180°F
- **FLUID VISCOSITY:** 70 SUS at operating temperature



PRICE	PART#	DESCRIPTION	DISPLACEMENT	RPM/3 GPM	RPM/6 GPM	RING SIZE
\$308.78	CL103-1002-012	Motor, 3/8" Ring	4.5	146	293	3/8"
\$472.00	CL103-1003-012	Motor, 1/2" Ring	5.9	112	225	1/2"
\$499.36	CL103-1004-012	Motor, 7/8" Ring	9.7	68	136	7/8"
\$512.17	CL103-1005-012	Motor, 1" Ring	11.3	58	117	1"
\$603.13	CL103-1006-012	Motor, 1 1/4" Ring	14.1	47	95	1 1/4"
\$601.09	CL103-1008-012	Motor, 2" Ring	22.6	30	60	2"
\$95.75	CLP22000-2	4 Bolt Mount Flange 009-010				
\$58.68	CLP9900101	Hydraulic Motor Seal Kit				

CHAR-LYNN® S-PLUS MOTOR - 7/8"-14 SAE O-RING

HANNA PARTS

- **MAXIMUM CASE PRESSURE:** 1500 PSI
- **MAXIMUM TEMPERATURE:** 180°F



PRICE	PART#	DISPLACEMENT	MAX RPM	SHAFT	PORT	RING SIZE
\$556.85	CL103-3581-012	3.6	963	1"	7/8" SAE	1 9/64"

MITTER MOTORS & REPLACEMENT PARTS

ROD ENDS - MALE THREADED RIGHT HAND WITH ZERK (GREASE FITTING) - 3 PIECE - COMMERCIAL - SINTERED BRONZE

HANNA PARTS



PRICE	KR PART #	MFG. PART #	SIZE
\$14.71	VM8G	M8SBZ	1/2"
\$25.14	VM12G	M12SBZ	3/4"



CHAR-LYNN® S SERIES MOTOR - 1/2"-14 FPT

HANNA PARTS

- **MAX. CASE PRESSURE:** 1500 PSI
- **MAX. TEMPERATURE:** 180°F

PRICE	PART#	DISPLACEMENT	SHAFT	RING SIZE
\$556.85	CL103-2030-012	14.10	1"	7/16"-20 UNF

HANNA™ REPLACEMENT PRODUCTS

PUMPS - VALVES - HYDROMINDERS

FLOJET G57 SERIES AIR-OPERATED PUMPS

HANNA PARTS



- MAX FLOW RATE: 5 GPM
- PRESSURE RATING: 20-100 PSI
- AIR INLET: 1/4" brass hose barb
- PRODUCT INLET: 1/2" hose barb
- PRODUCT OUTLET: 1/2" hose barb

PRICE	PART #	DIAPHRAGM	PORT KIT
\$104.29	FP7040	SANTOPRENE	FPK06B
\$145.98	FP7020	VITON	FPK06V



FLOJET G57 SERIES AIR-OPERATED PUMPS

HANNA PARTS



- MAX FLOW RATE: 5 GPM
- PRESSURE RATING: 20-100 PSI
- AIR CONSUMPTION: 1 SCFM at 100 PSI
- AIR INLET: 1/4" brass hose barb
- PRODUCT INLET: 1/2" PushLock
- PRODUCT OUTLET: 1/2" PushLock

PRICE	PART #	DIAPHRAGM
\$171.83	FP575145	SANTOPRENE
\$185.33	FP573145	VITON
\$242.01	FP57142	KALREZ



PUSH LOCK & STEP-DOWN BARB FITTINGS

HANNA PARTS



PRICE	PART #	DIAPHRAGM
\$6.04	FPK06V	FLOJET HOSE BARB - Viton - 3/8" x 1/2"
\$15.19	FPK06PT	FLOJET PUSH-IN POLYTUBE FITTING - VITON - 3/8"
\$24.89	FPK08PT	FLOJET PUSH-IN POLYTUB FITTING - Viton - 1/2"

PRICE	PART #	DIAPHRAGM
\$21.23	FPK20381061	FLOJET PUSH-IN TUBE - EPDM - 1/2"
\$3.97	FPK01510	FLOJET BRASS AIR INLET - 1/4"

511 HYDROMINDER - LOW VOLUME UNIT WITH SIPHON BEAKER (4½ GPM)

HANNA PARTS



\$167.50 IN511

515 HYDROMINDER - LOW VOLUME UNIT WITH SIPHON BEAKER & MOUNTING BRACKET (1½ GPM)

HANNA PARTS



\$210.75 IN515

530 HYDROMINDER - MEDIUM VOLUME UNIT WITH SIPHON BEAKER & MOUNTING BRACKET (1½ GPM)

HANNA PARTS



\$319.14 IN530

VALVES - INJECTORS

DEMA PILOT-PISTON NORMALLY CLOSED SOLENOID VALVES

HANNA PARTS



- BODY: Brass
- SEAL: Teflon
- PRESSURE RATING: 3-150 PSI
- JUNCTION BOX: 24V / 110V

PRICE	PART #	SIZE	VOLTAGE	PRICE	PART #	SIZE	VOLTAGE
\$73.55	SOD414P24	1/2"	24V	\$101.22	SOD416P24	3/4"	24V
\$73.55	SOD414P120	1/2"	120V	\$101.21	SOD416P120	3/4"	120V



DEMA 204B 1/2" ADJUSTABLE INJECTOR

HANNA PARTS



- Brass
- Screw adjustable
- 2.0 - 35 GPM
- Max. Induction: 36 oz/min

\$67.32 IN204B

DEMA 206B 3/4" ADJUSTABLE INJECTOR

HANNA PARTS



- Brass
- Screw adjustable
- 11 - 39 GPM
- Max. Induction: 42 oz/min

\$84.31 IN206B

CONDUIT COIL

HANNA PARTS



- 10 Watts (AC)
- 1/2" NPT conduit
- Class F

\$55.59 SOPC500 24V AC
\$55.60 SOPC505 110V

1/4" 3 WAY SOLENOID

HANNA PARTS



- 24V AC
- 1/2" NPT Conduit
- Rotates 360° for easy installation

\$165.13 SOP1135

HANNA™ REPLACEMENT PRODUCTS

WATER WIZARD REPLACEMENT PARTS



DEMA STAINLESS STEEL DIRECT ACTING 1/4" SOLENOID VALVE

HANNA PARTS

- **BODY:** Stainless Steel
- **SEAL:** Buna-N
- **MAX PRESSURE:** 150 PSI
- **INLET/OUTLET:** 1/4" NPT
- 24V AC

CALL SOD42424



DEMA 24V HIGH PRESSURE SOLENOID VALVES - BRASS BODY - TEFLON SEAL

HANNA PARTS

\$88.51	SOD453P24	3/8"
\$133.36	SOD454P24	1/2"
\$227.37	SOD458P24	1"



DEMA SOLENOID REPAIR KITS

HANNA PARTS

\$48.67	SODK4131	3/8" Repair Kit - 453P Models
\$41.48	SODK4132	1/2" Repair Kit - 454P Models
\$73.49	SODK4133	1" Repair Kit - 458P Models



90° 3/8" MOSMATIC SWIVEL

HANNA PARTS

\$92.68 SWM43262



WATLOW 240V 1" TANK HEATER

HANNA™ PARTS

- Heats to 110°F
- With thermostat
- Stainless steel construction

\$248.44 WH0500



DEMA 24VAC 2 COIL JUNCTION BOX

HANNA PARTS

CALL SODP419C2348



GENERAL PUMP® TRAPPED PRESSURE UNLOADER

HANNA PARTS

- **PRESSURE:** 2450 PSI
- **MAX FLOW:** 53 GPM
- **BYPASS:** 1" NPTF
- **INLET:** 1" NPTF
- **OUTLET:** 1" NPTF
- **MAX. TEMP:** 200°F

\$361.99 GPU5221



0-3000 PSI LIQUID FILLED 1/4" PRESSURE GAUGE - REAR MOUNT

HANNA PARTS

\$15.00 GAL3000R



CAT PUMPS® 3535 SERIES CERAMIC PLUNGER PUMP

HANNA PARTS

- **FLOW:** 36 GPM
- **PRESSURE:** 100 - 1200 PSI
- **RPM:** 800 RPM

\$4,660.68 PU03535



CAT PUMPS® 3535 SERIES KITS & OIL

HANNA PARTS

PART #	DESCRIPTION	KITS NEEDED
PU34235	Valve Kit	x 2
PU31040	Seal Kit	x 1
PU92674	Pump Rails	-
Factory Sized	Pump Pulley	-
PU06100	21 oz. bottle	
PU06105	2.5 gallons	



ARIMITSU® 3615 SERIES DUAL SHAFT PUMP

HANNA PARTS

- **FLOW:** 36 GPM
- **PRESSURE:** 1600 PSI
- **RPM:** 800 RPM

CALL ARM3615



ARIMITSU® 3615 SERIES KITS & OIL

HANNA PARTS

PART #	DESCRIPTION
ARM30136	Seal Kit
ARM30137	Valve Kit
ARM30103	Arimitsu Oil - 32 oz.

HANNA™ REPLACEMENT PRODUCTS

AUTO PREP WASHER PARTS



D25-X HYDRA-CELL PUMP

HANNA PARTS

- MAX FLOW: 20 GPM
- MAX TEMP: 250°F
- INLET: 1½"
- SHAFT DIAMETER: 1⅝"
- MAX PSI: 1000
- MAX RPM: 1050
- OUTLET: 1" NPT

\$3,637.93 WPH25XKBTH

D25-X HYDRA-CELL PUMP PARTS

HANNA PARTS

\$22.09	WPD030391030	Oil Fill Cap W/ O-Ring
\$140.63	WPD25D52TX	H25 Diaphragm
\$406.26	D25K52THFEC	H25 Repair Kit
\$250.01	WPA031751102	H/G-25 Tool Kit
\$881.18	WPA031751107	Master Tool Kit



WANNER 1" REGULATOR VALVE

HANNA PARTS

- FLOW: 20 GPM
- PSI: 500-1000

\$368.55 WPC23ABBNSJG



WANNER ¾" REGULATOR VALVE

HANNA PARTS

- MAX. FLOW: 14 GPM
- PSI: 500-2500

\$516.75 WPC62ABBSSEF



3 PHASE BALDOR MOTOR 10 HP/1750 RPM/TEFC

HANNA PARTS

\$1,738.77 MBEM3313T



GENERAL PUMP® ¼" SPRAY TIP

HANNA PARTS

PRICE	PART #	TYPE
\$3.79	GPN1504M4	1504

MACNEIL®

MACNEIL® REPLACEMENT PRODUCTS

RG44 CONVEYOR WASH PARTS



BELL SIGNAL HOSE

MACNEIL PARTS

- ¾" hose • .110 wall

\$1.00 / FT H00150



LLDPE POLY TUBING

MACNEIL PARTS

- ¾" hose
- 120 PSI • 100 ft

\$30.15 PT300BK-100



#16 NORMALLY OPEN AIR SWITCH

MACNEIL PARTS

\$15.80 AS16



HOSE ANCHOR PARTS

\$21.13 AS14

HYDRAULIC & ELECTRIC DRIVES



2000 SERIES CHAR-LYNN® MOTORS

MACNEIL PARTS

PRICE	PART#	DESCRIPTION
\$656.86	CL106-1014-006	Motor, 18.7 cu"/ Rev
\$686.22	CL106-1015-006	Motor, 24.9 cu"/ Rev



1760RPM/182TC 230/460 STERLING MOTOR

MACNEIL PARTS

PRICE	PART#	DESCRIPTION
\$764.50	MSE3000	3 HP
\$843.50	MSE3005	5 HP

AUTOMATICS & TUNNELS

MACNEIL® REPLACEMENT PRODUCTS

ROLLERS & CHAIN



CHAIN SECTIONS MACNEIL PARTS

- Sold in 10' sections
- Price is per 10'

\$107.07 X458



BAR MACNEIL PARTS

\$4.75 X458BAR



PIN MACNEIL PARTS

\$2.40 X458PIN



CARRIER LINK MACNEIL PARTS

\$25.61 CLX348



CENTER LINK MACNEIL PARTS

\$4.78 X458LINK

ROLLERS & CHAIN

ROD ENDS - 1/2" FEMALE THREADED RIGHT HAND WITH ZERK (GREASE FITTING) - 3 PIECE - COMMERCIAL - SINTERED BRONZE AUTOMATICS HARDWARE



PRICE	KR PART #	MFG. PART #
\$13.81	VF8G	F8SBZ

CHECK VALVES

CHECK VALVE WITH VITON SEALS MACNEIL PARTS



PRICE	PART#	DESCRIPTION
\$11.42	CV0090-4F4P	1/4" F X 1/4" Push Connect
\$11.58	CV0090-4F6P	1/4" F X 3/8" Push Connect

New!



GEARMOTOR FOR MACNEIL GLOSS BOSS MACNEIL PARTS

- Phase 3 • 1 HP • 75 RPM
- 208/230/460 VAC

\$1,711.64	RYMAC300	Gear Ratio- 25:1
\$1,641.64	RYMAC302	Gear Ratio- 11:1
\$1,481.05	RYMAC304	Gear Ratio- 16:1

New!



IDLER SPROCKET RYKO PARTS

- Used to replace worn or broken idler sprockets for Belanger DuraTrans conveyers
- For Use With: 20162-823, BELANGER 1SPROC410, VT2000, MacNeil, Conveyers made before 2002

\$212.59 RYBC145

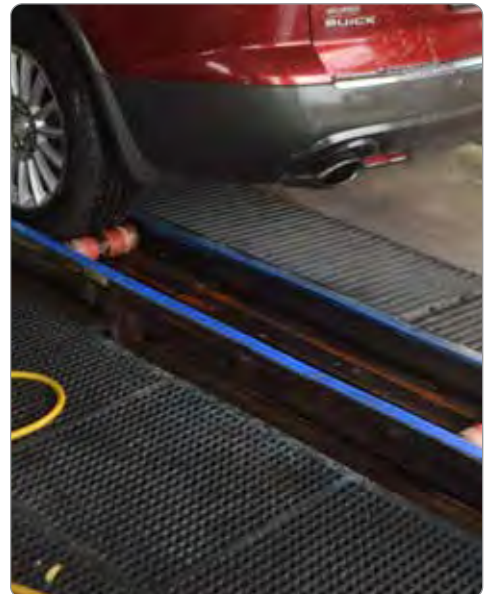

AUTOMATICS & TUNNELS

SOUTHERN PRIDE® REPLACEMENT PRODUCTS



DRIVE SHAFT ASSEMBLY
SOUTHERN PRIDE REPLACEMENT PARTS

• Southern Pride # 372264A, 247033, 247038

\$584.19 SP2135



IDLER SHAFT ASSEMBLY
SOUTHERN PRIDE REPLACEMENT PARTS

• Southern Pride # 372663, 247037, 247039

\$516.43 SP2130



DRIVE ASSEMBLY PLATE
SOUTHERN PRIDE REPLACEMENT PARTS

• Southern Pride # 370269

\$122.85 SP2125



DISC ASSEMBLY
SOUTHERN PRIDE REPLACEMENT PARTS

• Southern Pride # 370269

\$122.85 SP2115



BEARING HOUSE ASSEMBLY
SOUTHERN PRIDE REPLACEMENT PARTS

• Southern Pride # 372908

CALL SP2110



DRIVE ROLLER & (2) 8" DRIVE DISCS
SOUTHERN PRIDE REPLACEMENT PARTS

• Southern Pride # 247033, 247038

\$40.20 HSAP92016



6" IDLER DISC & ROLLER
SOUTHERN PRIDE REPLACEMENT PARTS

• Southern Pride # 247037, 247039

\$40.20 HSAP92017



BRASS SPINDLES
SOUTHERN PRIDE REPLACEMENT PARTS

\$142.71	SP2100	2 Hole	SP# 370203
\$139.35	SP2105	3 Hole	SP# 370205



SKYTRACK IDLER & DRIVE WHEEL
SOUTHERN PRIDE REPLACEMENT PARTS

\$87.48 SP2150



8" DRIVE ROLLER DISC
SOUTHERN PRIDE REPLACE. PARTS

\$86.71 SP0019



DRIVE ROLLER
SOUTHERN PRIDE REPLACE. PARTS

\$68.85 SP0021



ROLLER GUIDE ASSEMBLY
SOUTHERN PRIDE REPLACE. PARTS

• Southern Pride # 370337

\$75.55 SP2140



1" CASTLE NUT
SOUTHERN PRIDE REPLACE. PARTS

• Southern Pride # 372667

\$13.15 HSCS82153A

AUTOMATICS & TUNNELS

LASERWASH G5™ REPLACEMENT PARTS



TROLLEY DRIVE BELT
LASERWASH REPLACEMENT PARTS

\$113.78 BB1000



BRIDGE DRIVE BELT
LASERWASH REPLACEMENT PARTS

\$299.79 BB1001



ARCH ENCODER
LASERWASH REPLACEMENT PARTS

\$276.47 BB1002



BRIDGE ENCODER
LASERWASH REPLACEMENT PARTS

\$255.25 BB1003



TROLLEY ENCODER
LASERWASH REPLACEMENT PARTS

\$255.29 BB1004



MANIFOLD BLOCK 1ST BREAKAWAY
LASERWASH REPLACEMENT PARTS

CALL BB1023



MANIFOLD BLOCK 1ST BREAKAWAY
LASERWASH REPLACEMENT PARTS

CALL BB1007



SWIVEL
LASERWASH REPLACEMENT PARTS

\$786.36 SWM40936



BREAKAWAY ASSEMBLY BOLT
LASERWASH PARTS

\$98.18 BB1009



BRIDGE BEARING MAIN DRIVE SHAFT
LASERWASH PARTS

\$63.55 BB1010



LOWER BEARING CENTRAL BRIDGE FRAME
LASERWASH PARTS

\$61.88 BB1011



UPPER BEARING CENTRAL BRIDGE FRAME
LASERWASH PARTS

\$58.88 BB1012



BRIDGE & DRYER SHAFT
LASERWASH PARTS

CALL BB1013



INNER ROLLER TROLLEY
LASERWASH REPLACEMENT PARTS

\$131.72 BB1021



DRIVER SIDE TROLLEY SHAFT
LASERWASH REPLACEMENT PARTS

CALL BB1022



OUTER ROLLER TROLLEY
LASERWASH REPLACEMENT PARTS

\$51.83 BB1024



BRIDGE ROLLER W/ BELT RELIEF
LASERWASH REPLACEMENT PARTS

\$72.14 BB1025



BRIDGE & DRYER GUIDE ROLLER SHAFT
REPLACEMENT PARTS

CALL BB1014



TROLLEY RETAINER ROLLER
REPLACEMENT PARTS

CALL BB1015



BRIDGE FRAME SHAFT
REPLACEMENT PARTS

\$93.91 BB1016



BRONZE BOLT SPRAY ARCH
REPLACEMENT PARTS

CALL BB1008



IDLER ROLLER SHAFT BRIDGE
REPLACEMENT PARTS

CALL BB1017



BRIDGE & DRYER ROLLER DELRIN
REPLACEMENT PARTS

\$58.26 BB1018

AUTOMATICS & TUNNELS

POPULAR REPLACEMENT PARTS



CLEAR VINYL TUBE
1/4" I.D. x 3/8" O.D.
KLEEN-RITE HOSES

\$0.25

HCV04T



3/4" FLOAT VALVE
WALTER VALVES

\$43.20

FVW12



BALANCED PRESSURE REGULATORS
REPLACEMENT PARTS

\$163.35

REK5325

3/4" 2900 PSI

\$35.91

RE7075

3/8" 2000 PSI



CHECK VALVE - STAINLESS STEEL TEFLON
FLUID CONTROLS

\$25.35

CV0041T

3/8 HP

\$32.64

CV0071T

1/2 F x F

\$44.43

CV0080T

3/4 F x F



REGULATOR AIR 1/4" MINI
PARKER REGULATORS

\$26.41

REP119



STAINLESS STEEL CHEMICAL INJECTORS
GENERAL PUMP

\$37.40

GPP100333

.087

\$37.40

GPP100334

.083

\$37.40

GPP100336

.057



1" F x F SWIVEL
SUPER SWIVELS

\$122.15

SWSD169FF

90°

\$152.67

SWSD1601

Straight



MAC SOLENOID 4 WAY 1/4" 24V 150 PSI
AUTOMATICS PARTS

\$73.95

MAC2180



3/8" SOLENOID VALVE (LESS COIL)
DANFOSS VALVES

\$64.90

DF06LC



DANFOSS 24V AC SOLENOID COIL
DANFOSS

\$29.57

DF042N7520



FESTOONS - 5" TROLLEY, 3" SADDLE
AUTOMATICS PARTS

PRICE	PART #	DESCRIPTION
\$17.60	AMLFCTR1	Heavy Duty Galvanized
\$59.73	AMLFCTR1SS	Stainless Steel
\$24.38	AM33293	Plastic



4 1/2" SHEAR PIN BOLT
AUTOMATICS PARTS

\$6.50

AMLSB



BELANGER® VECTOR CARRIAGE SHUTTLE REPLACEMENT ROLLER
AUTOMATICS PARTS

• (4) per machine

\$191.87

7X4BLKWHLB



BRIDGE ROLLERS
AUTOMATICS PARTS

\$49.17

AMLBRW

White

\$49.17

AMLBRBK

Black



TIRE INNERTUBE 410-4
AUTOMATICS PARTS

\$17.75

AMLTUBE



TIRE 410/3 1/2-4 2-PLY TUBE TYPE
AUTOMATICS PARTS

\$27.75

AMLTIRE



TIRE RIM 4 x 1 5/16" STAINLESS STEEL
AUTOMATICS PARTS

\$27.99

AMLRIM-S



LASERWASH 4000 SPRAY TIPS BUNDLE
KLEEN-RITE KITS

• FOR AUTOMATIC CAR WASH SYSTEMS

- (11) SA1/4MEG-1504 Spraying Systems 1504 WashJet Spray Tip 1/4"
- (5) SA1/4MEG-1503 Spraying Systems 1503 WashJet Spray Tip 1/4"
- (1) SA1/4MEG-2503 Spraying Systems 2503 WashJet Spray Tip 1/4"
- (1) SA1/4MEG-4003 Spraying Systems 4003 WashJet Spray Tip 1/4"

\$80.77

KRK5000

AUTOMATICS & TUNNELS

D & S® REPLACEMENT PARTS



IDLER WHEEL
D&S REPLACEMENT PARTS

- D&S # 5WHL200-2

\$81.25 DS8130



IDLER ARM SPRING HOLDER
D&S REPLACEMENT PARTS

- D&S # 5IDL615

\$73.93 DS8125



DOUBLE PULLEY SPINNER
D&S REPLACEMENT PARTS

- D&S # 5BER200

\$514.75 DS8115



SINGLE PULLEY SPINNER
D&S REPLACEMENT PARTS

- D&S # 5BER100

\$502.00 DS8110



IDLER BAR ASSEMBLY
D&S REPLACEMENT PARTS

- D&S # 5IDL310

\$207.45 DS8120



T BAR
D&S REPLACEMENT PARTS

\$81.86 SWMTB87837

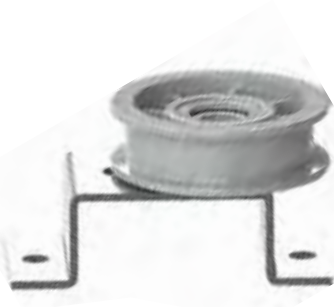

SINGLE PULLEY BELT TIGHTENER
D&S REPLACEMENT PARTS

- D&S # 5GAN618

\$142.71 DS8105



DOUBLE PULLEY BELT TIGHTENER
D&S REPLACEMENT PARTS

- D&S # 5PUL604

\$201.31 DS8100



90° 3/8" SWIVEL
D&S REPLACEMENT PARTS

\$92.68 SWM43262



3/8" M x F SWIVEL
D&S REPLACEMENT PARTS

\$144.81 SWM37163

AUTOMATICS & TUNNELS

PROXIMITY SWITCHES & SENSORS

PROXIMITY SWITCHES FROM TELEMECANIQUE FOR USE IN AUTOMATIC CAR WASHES TELEMECANIQUE



STP2120



STP2080

PRICE	PART #	MFG #	DESCRIPTION
\$185.46	STP2000	XS1M18PAS40D	Proximity Switch 24VDC 200MA
\$115.23	STP2060	XS4P30MA230	Inductive Proximity Switch
\$88.74	STP2090	XS612B1NAM12	M12 Connector/ 4mm Sensing Distance/ 12mm Dia
\$102.79	STP2080	XS530B1NAM12	M12 Connector/ 10mm Sensing Distance/ 30mm Dia
\$117.16	STP2100	XS618B1NAM12	18mm, M12 Connector, 8mm Sensing Distance
\$117.57	STP2110	XS1M30MA230K	3-Pin/ 10mm Sensing Distance/ 30mm Dia
\$107.11	STP2120	XS630B1NAM12	30mm Thread, 15mm Sensor with Connector
\$38.65	STP2150	XS118BLPAM12	Square-D Inductive Sensor - 18mm Shielded
\$82.27	STP2276	XS518B1NAM12	XS5 M18 OxiSense XS 50mm x 18mm Sensor 4-Pin M12 connector

OSISENSE XM PRESSURE TRANSMITTER SENSOR TELEMECANIQUE



- Used to measure and regulate fluid and steam pressure. Commonly used with booster pumps in car wash systems.
- **PRESSURE SENSOR SIZE:** 300 PSI
- **TEMPERATURE RANGE:** 32° to 176°F
- **FLUID CONNECTION TYPE:** 1/4" - 18 NPT (male)
- **ELECTRICAL CONNECTION:** 1 male connector M12 4 pins

\$114.45 STP3000

SENSOR CABLE FOR PROXIMITY SWITCH MURR ELEKTRONIK



STPCV1G2M



STPCV1G5M



STPCV1WYE2M



STPCV1WYE5M

PRICE	PART	SIZE
\$19.58	STPCV1G2M	6' Straight end
\$27.66	STPCV1G5M	12' Straight end
\$22.48	STPCV1WYE2M	6' Right angle
\$28.61	STPCV1WYE5M	12' Right angle

PROXIMITY SWITCHES TURCK SENSORS

TURCK



TPS1001



TPS1015



TPS1055



TPS1020

PRICE	PART #	TURCK #	DESCRIPTION	CONNECTION
\$132.43	TPS1000	NI15U-EM18WD-AN6X-H1141	Inductive Sensor	Quick Disconnect
\$151.75	TPS1001	NI12U-EM18WD-AN6X-H1141/S1163	Proximity Switch	Quick Disconnect
\$667.66	TPS1010	NI75U-CP80-AN6X2-H1141	Proximity Switch	Quick Disconnect
\$297.44	TPS1020	NI75U-CP80-AN6X2	Inductive Sensor	Wire Leads
\$98.61	TPS1025	BI10-P30-AN6X-B2141	Inductive Sensor	Quick Disconnect
\$191.22	TPS1030	BI5-S18-AD4X-H1141	Inductive Sensor	Quick Disconnect
\$113.26	TPS1035	NI12U-M18-AN6X-H1141	Inductive Sensor	Quick Disconnect
\$133.49	TPS1040	BI10U-EM30-AN6X-H1141	Inductive Sensor	Quick Disconnect
\$139.43	TPS1045	NI20U-EM30-AP6X-H1141	Inductive Sensor	Quick Disconnect
\$335.48	TPS1055	NI75U-CP80-AP6X2-H1141	Pancake Switch	Quick Disconnect
\$306.20	TPS1060	NI20U-EM30-AN6X-H1141	Inductive Sensor	Quick Disconnect
\$126.41	TPS1090	BI10-S30AZ3X7M	Proximity Switch	Wire Leads
\$139.50	TPS1140	BI15-EM30-AN45XLD-0.2MRS4T	Proximity Switch	Pigtail Quick Disconnect
\$98.61	TPS1190	BI10-S30-AD4X-H1141	Inductive Sensor	Quick Disconnect
\$98.61	TPS1195	BI10-S30-AN6X-H1141	Inductive Sensor	Quick Disconnect

CORD SETS TURCK SENSORS

TURCK



TPSC5050



TPSC5010

PRICE	PART #	TURCK #	DESCRIPTION	CONNECTION
\$36.68	TPSC5000	WK4.5T-10	Cordset - 90°, 5 Wire	M12 Eurofast
\$29.07	TPSC5010	WK4.4T-4	Cordset - 90°, 4 Wire	M12 Eurofast
\$35.86	TPSC5015	RKC4.4T-4	Cordset - Straight, 4 Wire	M12 Eurofast
\$22.95	TPSC5020	RK4T-8	Cordset - Straight, 3 Wire	M12 Eurofast
\$19.76	TPSC5025	RK4T-6	Cordset - Straight, 3 Wire	M12 Eurofast
\$62.16	TPSC5030	RKCV6T6-S618/NO	Cordset - Straight, 6 Wire	Wire Leads
\$13.33	TPSC5035	RK4T-2	Cordset - Straight, 3 Wire	M12 Eurofast
\$19.76	TPSC5040	WK4T-6	Cordset - 90°, 3 Wire	M12 Eurofast
\$54.52	TPSC5050	WKV4.4T-6/S618	Cordset - 90°, 4 Wire	Wire Leads
\$65.24	TPSC5055	WKV4.4T-15	Cordset - 90°, 4 Wire	Wire Leads
\$32.53	TPSC5065	WK4.4T-10	Cordset - 90°, 4 Wire	M12 Eurofast
\$43.49	TPSC5070	WK4.4T-12	Cordset - 90°, 4 Wire	M12 Eurofast
\$16.53	TPSC5075	WK4T-4	Cordset - 90°, 3 Wire	M12 Eurofast
\$12.95	TPSC5080	WK4T-2	Cordset - 90°, 3 Wire	M12 Eurofast

AUTOMATICS & TUNNELS



SENSORS

PANTRON 24VAC & 115VAC PHOTO EYE KIT

PANTRON SENSOR TECHNOLOGY



INCLUDES:

- Transmitter with 15M (49') Cable (KR# PPST1005 / Pantron# IT-M12-15M)
- Amplifier, 24VAC (KR# PPSA0124-24 / Pantron# ISG-A124-24)
- Socket, 11-Pole (KR# PPSP3000 / Pantron# MB11)
- Enclosure (KR# PPSP3010 / Pantron# PanBox 1 x 1)
- Receiver w/ 15M (49') Cable (KR# PPSR1005 / Pantron# IR-M12-15M)

\$329.83	PPSK0015-24	24VAC Kit
\$329.83	PPSK0015-115	115VAC Kit

TRANSMITTERS & RECEIVERS

PANTRON SENSOR TECHNOLOGY

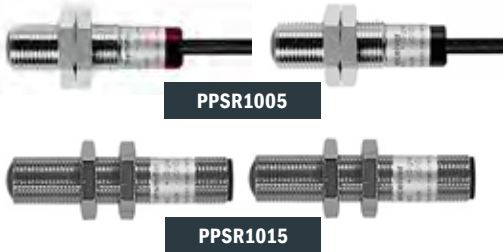

\$107.07	PPSR1005	Pantron M12 Series Receiver	Nickel Plated Brass, 15M (49ft) Cable
\$71.28	PPST1005	Pantron M12 Series Transmitter	Nickel Plated Brass, 15M (49ft) Cable
\$80.80	PPST1005-HP	Pantron M12 Series High Powered Transmitter	Nickel Plated Brass, 15M (49ft) Cable
\$150.51	PPSR1010	Pantron M12 Series Receiver	Nickel Plated Brass, 35M (114ft) Cable
\$101.02	PPST1010	Pantron M12 Series Transmitter	Nickel Plated Brass, 35M (114ft) Cable
\$95.87	PPST1010-HP	Pantron M12 Series High Powered Transmitter	Nickel Plated Brass, 35M (114ft) Cable
\$58.02	PPSR1015	Pantron M12 Series Receiver	Nickel Plated Brass, M12 Connector
\$45.69	PPST1015	Pantron M12 Series Transmitter	Nickel Plated Brass, M12 Connector
\$53.09	PPST1015-HP	Pantron M12 Series High Powered Transmitter	Nickel Plated Brass, M12 Connector

CABLES (FOR QUICK CONNECT SENSORS)

PANTRON SENSOR TECHNOLOGY

\$31.00	PPSC2000-15	Pantron Right Angle M12 Female Cable	3-Wire, 15M (49ft)
\$53.37	PPSC2000-35	Pantron Right Angle M12 Female Cable	3-Wire, 35M (114ft)

AMPLIFIERS

PANTRON SENSOR TECHNOLOGY

\$172.07	PPSA0124-24	Pantron ISG-A124 Series Automatic Test Amplifier	24VAC
\$172.07	PPSA0124-115	Pantron ISG-A124 Series Automatic Test Amplifier	115VAC
\$172.05	PPSA0124-230	Pantron ISG-A124 Series Automatic Test Amplifier	230VAC
\$185.18	PPSA0124-24DC	Pantron ISG-A124 Series Automatic Test Amplifier	24VDC
\$182.10	PPSA0134-24	Pantron ISG-A134 Series Automatic Test Amplifier w/ Time Delay	24VAC
\$182.10	PPSA0134-115	Pantron ISG-A134 Series Automatic Test Amplifier w/ Time Delay	115VAC
\$198.29	PPSA0134-24DC	Pantron ISG-A134 Series Automatic Test Amplifier w/ Time Delay	24VDC
\$125.77	PPSA0024-24	Pantron ISG-N24 Series Manual Test Amplifier	24VAC
\$125.76	PPSA0024-115	Pantron ISG-N24 Series Manual Test Amplifier	115VAC
\$125.76	PPSA0024-230	Pantron ISG-N24 Series Manual Test Amplifier	230VAC
\$141.97	PPSA0024-24DC	Pantron ISG-N24 Series Manual Test Amplifier	24VDC
\$141.97	PPSA0034-24	Pantron ISG-N34 Series Manual Test Amplifier w/ Time Delay	24VAC
\$141.97	PPSA0034-115	Pantron ISG-N34 Series Manual Test Amplifier w/ Time Delay	115VAC
\$141.97	PPSA0034-230	Pantron ISG-N34 Series Manual Test Amplifier w/ Time Delay	230VAC
\$152.00	PPSA0034-24DC	Pantron ISG-N34 Series Manual Test Amplifier w/ Time Delay	24VDC

MULTIPLEXERS

PANTRON SENSOR TECHNOLOGY

\$389.28	PPSM4000	Pantron ISM Series Infrared Photoelectric Multiplexer, 4 Channel	24VDC
\$600.31	PPSM8000	Pantron ISM Series Infrared Photoelectric Multiplexer, 8 Channel	24VDC
\$277.77	PPSM2034-24	Pantron IMX Series Infrared Photoelectric Multiplexer, 2 Channel	24VAC
\$277.77	PPSM2034-115	Pantron IMX Series Infrared Photoelectric Multiplexer, 2 Channel	115VAC
\$282.41	PPSM2034-24DC	Pantron IMX Series Infrared Photoelectric Multiplexer, 2 Channel	24VDC

ACCESSORIES

PANTRON SENSOR TECHNOLOGY

\$11.97	PPSP3000	Pantron 11-Pole Amplifier Socket (For Din-Rail Mounting and Retaining Clip)
\$12.82	PPSP3005	Pantron L-Bracket (for mounting 12mm Photo Eyes)
\$72.10	PPSP3010	PanBox Protective Enclosure for 1 x single channel, 5" x 5" x 5"
\$5.57	PPSP3015	Pantron Din Rail, Aluminum, 35mm wide x 10mm high x 4" length (for use w/ PPSP3010)

ISG-A124 SERIES



ISG-A134 SERIES



ISG-N24 SERIES



ISG-N34 SERIES



PPSM4000



PPSM2034-115



PPSP3000

AUTOMATICS & TUNNELS



SENSORS



BPS1090



BPS1085



BPS1025



BPS1040



BPS1000



BPS1040

PHOTOELECTRIC SENSORS BY BANNER

BANNER ENGINEERING

PRICE	PART #	BANNER #	DESCRIPTION	CONNECTION TYPE
\$49.95	BPS1000	S186E	Banner Emitter	Wire Connection
\$70.58	BPS1005	S18SP6D	Banner Proximity Switch	Wire Connection
\$64.07	BPS1015	S18SP6R	Banner Receiver	Wire Connection
\$262.79	BPS1020	SM30PRLQD	Banner Receiver	Quick Disconnect
\$331.18	BPS1025	SM30PRL W/30	Banner Receiver	Wire Connection
\$244.32	BPS1040	SMA30PELQD	Banner Emitter	Quick Disconnect
\$304.00	BPS1030	SMA30PEL W/30	Banner Emitter	Wire Connection
\$290.97	BPS1035	SM2A30PRL	Banner Receiver	Wire Connection
\$359.43	BPS1045	SM2A30PRLW 30'	Banner Receiver	Wire Connection
\$233.43	BPS1085	QS30ARXQP-74010	Banner Receiver	Quick Disconnect
\$221.51	BPS1090	QS30EXQP-74009	Banner Emitter	Quick Disconnect
\$262.74	BPS1110	SM30PRL	Banner Receiver	Wire Connection
\$244.29	BPS1115	SMA30PEL	Banner Emitter	Wire Connection
\$188.95	BPS1120	QS30RRX	Banner Receiver	Wire Connection
\$92.30	BPS1135	QS30EQ	Banner Emitter	Quick Disconnect
\$106.42	BPS1140	QS30RQ	Banner Receiver	Quick Disconnect
\$187.85	BPS1160	QS30EXQ	Banner Emitter	Quick Disconnect
\$188.95	BPS1165	QS30ARXQ	Banner Receiver	Quick Disconnect



CORD SETS BY BANNER

BANNER® ENGINEERING

PRICE	PART #	BANNER #	DESCRIPTION	CONNECTION TYPE
\$34.75	BPSC5000	MQDC1-506	Banner Cable - 2 Meter, Straight, 5 Pin	Quick Disconnect
\$40.17	BPSC5005	MQDC1-515	Banner Cable - 5 Meter, Straight, 5 Pin	Quick Disconnect
\$59.72	BPSC5010	MQDC1-530	Banner Cable - 9 Meter, Straight, 5 Pin	Quick Disconnect
\$20.26	BPSC5015	MQDC1-506RA	Banner Cable - 2 Meter, 90°, 5 Pin	Euro-Style Quick Disconnect
\$153.11	BPSC5020	MBCC-430	Banner Cable - 9 Meter, Straight, 4 Pin	Mini-style Quick Disconnect
\$153.11	BPSC5025	MBCC-330	Banner Cable - 9 Meter, Straight, 3 Pin	Mini-style Quick Disconnect
\$73.84	BPSC5030	MBCC-412	Banner Cable - 4 Meter, Straight, 4 Pin	Mini-style Quick Disconnect
\$65.15	BPSC5040	SM30CC-306	Banner Cable - 2 Meter, Straight, 3 Pin	Mini-style Quick Disconnect
\$196.55	BPS1310	SMICC-350	Banner Cable - 50' Long, Straight, 3 Pin	Mini-style Quick Disconnect
\$228.03	BPSC5085	MBCC-460	Banner Cable - 60' Long, Straight, 4 Pin	Mini-style Quick Disconnect
\$40.17	BPSC5050	MQDC1-515RA	Banner Cable - 5 Meter, 90°, 5 Pin	Euro-Style Quick Disconnect
\$59.72	BPSC5055	MQDC1-530RA	Banner Cable - 9 Meter, 90°, 5 Pin	Euro-Style Quick Disconnect
\$133.55	BPSC6000	MQDC20SS-506	Banner Cable - 6.5' Long, 5 Pin - Stainless Steel Coupling Nut	Euro-Style Quick Disconnect
\$168.32	BPSC6010	MQDC20SS-515	Banner Cable - 15' Long, 5 Pin - Stainless Steel Coupling Nut	Euro-Style Quick Disconnect
\$206.32	BPSC6020	MQDC20SS-530	Banner Cable - 30' Long, 5 Pin - Stainless Steel Coupling Nut	Euro-Style Quick Disconnect
\$192.21	BPSC6025	MQDC20SS-533RA	Banner Cable - 30' Long, 5 Pin, 90° - Stainless Steel Coupling Nut	Euro-Style Quick Disconnect
\$27.86	BPSC6200	MQDS-WDSS-0406	Banner Cable - 6.5' Long, 4 Pin - SS Abrasion Resistant	Euro-Style Quick Disconnect
\$52.13	BPSC6205	MQDS-WDSS-0415	Banner Cable - 15' Long, 4 Pin - SS Abrasion Resistant	Euro-Style Quick Disconnect
\$59.72	BPSC6210	MQDS-WDSS-0430	Banner Cable - 30' Long, 4 Pin - SS Abrasion Resistant	Euro-Style Quick Disconnect
\$48.87	BPSC6215	MQDS-WDSS-0506	Banner Cable - 6.5' Long, 5 Pin - SS Abrasion Resistant	Euro-Style Quick Disconnect
\$55.39	BPSC6220	MQDS-WDSS-0515	Banner Cable - 15' Long, 5 Pin - SS Abrasion Resistant	Euro-Style Quick Disconnect
\$62.98	BPSC6225	MQDS-WDSS-0530	Banner Cable - 30' Long, 5 Pin - SS Abrasion Resistant	Euro-Style Quick Disconnect
\$42.35	BPSC6230-06	MQDC-606	Banner Cable - 6.5' Long, 6 Pin Straight - Chrome-plated brass coupling nut	Euro-Style Quick Disconnect
\$53.21	BPSC6230-15	MQDC-615	Banner Cable - 15' Long, 6 Pin Straight - Chrome-plated brass coupling nut	Euro-Style Quick Disconnect
\$64.61	BPSC6230	MQDC-630	Banner Cable - 30' Long, 6 Pin Straight - Chrome-plated brass coupling nut	Euro-Style Quick Disconnect
\$40.18	BPSC6230-06RA	MQDC-606RA	Banner Cable - 6.5' Long - 6 Pin Right Angle - Chrome-plated brass coupling nut	Euro-Style Quick Disconnect
\$53.21	BPSC6230-15RA	MQDC-615RA	Banner Cable - 15' Long - 6 Pin Right Angle - Chrome-plated brass coupling nut	Euro-Style Quick Disconnect
\$62.98	BPSC6230-30RA	MQDC-630RA	Banner Cable - 30 Long - 6 Pin Right Angle - Chrome-plated brass coupling nut	Euro-Style Quick Disconnect

ALL PRICES ARE F.O.B. AND ARE SUBJECT TO CHANGE WITHOUT NOTICE • NO C.O.D.'S

1-800-233-3873 • (717) 684-6721 • FAX (800) 446-0495 • KLEENRITE.COM

AUTOMATICS & TUNNELS



SENSORS

TSMR54251



TLR05CW



TP80459A



TP80499A



Telco amplifiers feature manual sensitivity adjustment, allowing for numerous configurations to suit your needs.



TPPA0324VDC



TLR1105



TMPA21B503-05

RECEIVERS

TELCO SENSORS

PRICE	PART #	TELCO PART #	DESCRIPTION
\$191.07	SMR5425/1NGK	SMR5425/1NGK	Car wash receiver, M18, NPN, NO/NC, 4P M12 quick disconnect. 3-80ft range. DOES NOT INCLUDE CABLE.
\$78.67	TLR110	LR110LTB58J-CC	Quick disconnect receiver (sensor only). High powered, thru-beam. M 12 housing. DOES NOT INCLUDE CABLE.
\$85.87	TLR05CW	LR05CW	Car wash receiver, M12, 50ft cable
\$89.72	TLR115	LR05LCW	Car wash receiver with LED, M12, 50ft cable

CABLES

TELCO SENSORS

PRICE	PART #	TELCO PART #	DESCRIPTION
\$27.81	TP80459A	80459A	4 Pole, M12 Connector, Straight, 5 Meter, PVC Cable
\$41.13	TP80459A-10M	80459A-10M	4 Pole, M12 Connector, Straight, 10 Meter, PVC Cable
\$50.51	TP80459A-15M	80459A-15M	4 Pole, M12 Connector, Straight, 15 Meter, PVC Cable
\$27.81	TP80499A	80499A	4 Pole, M12 Connector, 90°, 5 Meter, PVC Cable
\$50.51	TP80499A-15M	80499A-15M	4 Pole, M12 Connector, 90°, 15 Meter, PVC Cable

AMPLIFIERS

TELCO SENSORS

PRICE	PART #	TELCO PART #	DESCRIPTION
\$144.69	TPA03115VAC	PA03-115VAC	Car Wash Amplifier, 115VAC, Relay/NPN Output
\$144.69	TPA0324VAC	PA03-24VAC	Car Wash Amplifier, 24VAC, Relay/NPN Output

ACCESSORIES

TELCO SENSORS

PRICE	PART #	TELCO PART #	DESCRIPTION
\$159.52	TMPA21B503-05	MPA21B503-05	Car Wash Multiplexer Amplifier, 24 VDC, 2 Individual Relays
\$8.15	TLR1105	TR11-05	Car Wash 11 Pin Socket

CAR WASH SETS

TELCO SENSORS

- Power ON indicator: Green LED
- Output indicator: Yellow LED
- Operation frequency: 10 Hz
- Response time ON/OFF: 40 ms/40 ms
- Sensing range: 230'

PRICE	PART #	TELCO PART #	DESCRIPTION
\$292.51	TPA0324VACSET	PA03-24VAC-SET	Car Wash Set 24VAC With LED, Relay/NPN Output Set of: 1-PA03-24VAC, 1-LR05LCW, 1-LT05LCW, 1-TR11-05
\$292.51	TPA0324VDCSET	PA03-24VDC-SET	Car Wash Set 24VDC With LED, Relay/NPN Output Set of: 1-PA03-24VDC, 1-LR05LCW, 1-LT05LCW, 1-TR11-05
\$292.51	TPA03115VACSET	PA03-115VAC-SET	Car Wash Set 115VAC With LED, Relay/NPN Output Set of: 1-PA03-115VAC, 1-LR05LCW, 1-LT05LCW, 1-TR11-05

REPLACEMENT PARTS - TRANSMITTERS

TELCO SENSORS

PRICE	PART #	TELCO PART #	DESCRIPTION
\$143.33	TL500CNGK-D	SMT5000CNGK	Car Wash Transmitter, M18, DC, With Control Wire, 4P M12 Quick Disconnect - 3-80ft Range. DOES NOT INCLUDE CABLE.
\$55.93	TLT100	LT100HLT58J-CC	Car Wash Transmitter With LED, M12, Hi-Power, 4P M12 Quick Disconnect DOES NOT INCLUDE CABLE.
\$57.07	TLT05CW	LT05CW	Car Wash Transmitter, M12, Hi-Power, 50 FT Cable
\$66.53	TLT115	LT05LCW	Car Wash Transmitter With LED, M12, Hi-Power, 50 FT Cable

TL5000CNGK-D



TLT05CW



SENSORS

AMPLIFIERS

CARLO GAVAZZI

PRICE	PART #	GAVAZZI PART #	DESCRIPTION
\$333.96	CGP1000	S142ARNN024	Basic Amplifier 24V AC. NPN & Alarm.
\$353.09	CGP1005	S142ARNN924	Basic Amplifier 24V AC/DC. NPN & Alarm.
\$16.46	CGP1020	ZPD11	11 Pin Socket For Amplifiers



CGP1000

RECEIVERS

CARLO GAVAZZI

PRICE	PART #	GAVAZZI PART #	DESCRIPTION
\$210.34	CGP2000	MOFR-M12-8	Receiver - M12 Connection 8° Optical Angle
\$158.75	CGP2005	MOFR-M14-8	Receiver - M14 Connection 8° Optical Angle
\$219.49	CGP2010	MOFR-M14-8-30.5M	Receiver - M12 Connection 8° Optical Angle w/ 100' Cable



CGP2010

TRANSMITTERS

CARLO GAVAZZI

PRICE	PART #	GAVAZZI PART #	DESCRIPTION
\$210.34	CGP3000	MOFT20-M12-8	Transmitter - M12 Connection 8° Optical Angle
\$184.05	CGP3005	MOFT20-M14-8	Transmitter - M14 Connection 8° Optical Angle



CGP2010

MISCELLANEOUS

CARLO GAVAZZI

PRICE	PART #	GAVAZZI PART #	DESCRIPTION
\$134.84	CGP4015	IA18DSN08NO	Inductive Proximity Sensor. M18 connection. 8mm range.



CGP4000



IFM0270

IFM EFFECTOR SENSORS

• Quick disconnect cordsets and field wirable connectors offer plug-and-play functionality for electrical wiring.

PRODUCT LINES INCLUDE:

- Female cordsets
- Patch cables
- Y-splitters
- COMBICON connector
- Male cordsets
- Female field wirables
- Male field wirables
- Wiring blocks

PRICE	PART #	THREAD	SIZE
\$133.33	IFM5541	12 mm	2 mm
\$142.05	IFM0270	30 mm	10 mm
CALL	IFM7107	30 mm	15 mm

AUTOMATICS & TUNNELS

REGORA
LEADERS IN PRESENCE DETECTION

TREADLES/SWITCHES



- ALSO AVAILABLE: RAMP SET - Turn any flat switch into a ramped switch
- AM300R: 24" x 5"

LOW
MAINTENANCE!
HUNDREDS OF
USES!

AUTO ALERT TREADLE SWITCHES

RECORA

- **AUTOMATIC VEHICLE DETECTORS FOR COMMERCIALS AND INDUSTRIAL USE**
- Ideal for turning equipment on without touching cars
- Rugged enough to work under multi-ton trucks
- Easily wires to lights, horn, bells, or any signaling device
 - Molded to 3/16" steel base plate, 7/8" thick, mounting holes on corners
- Standard sensitivity to 10-15 lbs.
- Standard lead wires are 20' of 18 AWG
- Lead lengths can be up to 150'

\$117.05	AM290	5" x 17"	Black
\$129.42	AM300	5" x 24"	Black
\$129.42	AM300Y	5" x 24"	Yellow
\$142.69	AM305	5" x 32"	Black
\$142.69	AM305Y	5" x 32"	Yellow
\$222.50	AM295	10" x 24"	Black
\$222.50	AM295Y	10" X 24"	Yellow

CLEATS GRIP THE TIRE AND MINIMIZE SLIPPAGE WHILE IMPROVING TRACTION.

SIMPLE ELECTRICAL SWITCH EMBEDDED IN THE TRIP DEVICE.

RECESSED, IT PERFORMS ITS FUNCTION WITHOUT GETTING IN THE WAY OF REGULAR MAINTENANCE AND CLEANING.

DESIGNED TO ROLL WATER OFF ITS BACK.

SIMPLE ELECTRICAL SWITCH EMBEDDED IN THE TRIP DEVICE.

RUGGED WATER AND WEATHER-RESISTANT DETECTOR WITH BUILT-IN RAMP IS DESIGNED AND MANUFACTURED TO LAST. SAVES ON COSTLY MAINTENANCE.

TRACTION CONTROL SERIES

RECORA

- Ideal for turning equipment on without touching cars
- Rugged enough to work under multi-ton trucks
- Sensitive enough to respond to the smallest, lightest cars
- Safe, fast, and easy to move in the wash tunnel or on the apron for exact timing control

\$141.15	AM310Y	5" x 24"	Yellow
\$141.15	AM310	5" x 24"	Black
\$154.23	AM315Y	5" x 32"	Yellow
\$154.23	AM315	5" x 32"	Black

N3 SERIES

RECORA

- Provides automatic vehicle detection without frequent maintenance concerns
- Manufactured for reliability
- Able to withstand severe weather conditions
- Extremely effective, yet uncomplicated - perfect for any drive-through wash system where additional systems need to be activated within the wash tunnel

\$134.29	AM320Y	3" x 24"	Yellow
\$134.29	AM320	3" x 24"	Black
\$142.24	AM325Y	3" x 32"	Yellow
\$142.24	AM325	3" x 32"	Black

AUTOMATICS & TUNNELS



TREADLES/SWITCHES



24" x 30" CAR WASH MAT SYSTEM

TAPESWITCH®

- WHY REPLACE THE COMPLETE MAT WHEN ONLY HALF NEEDS REPLACING? LESS MONEY, LESS WASTE, LESS SHIPPING COSTS!

TECHNICAL DATA:

- VOLTAGE: 24 VAC or DC
- ACTUATION FORCE: 15 lbs. nominal
- MOUNTING: 6 thru holes on each mat
12 thru holes on a mat system
- CURRENT RATING: 1 AMP
- MATERIAL: Molded PVC
- COLOR: Gray or Yellow

BLACK MAT SYSTEMS

PRICE	PART #	DESCRIPTION
\$560.03	TSCWRS2430	Mat System - 2 Mats
\$280.01	TSCWRS2430L	LEFT side mat ONLY
\$280.01	TSCWRS2430R	RIGHT side mat ONLY

YELLOW MAT SYSTEMS

PRICE	PART #	DESCRIPTION
\$560.03	TSCWRS2430-Y	Mat System - 2 Mats
\$280.01	TSCWRS2430L-Y	LEFT side mat ONLY
\$280.01	TSCWRS2430R-Y	RIGHT side mat ONLY

REPLACEMENT FOR 2 POSITION RAMPED FLOOR SWITCH
PART NUMBERS HSP92208, TSCWR2430B AND TSCWR2430A



REGULAR SQUARE FLOOR SWITCHES

TAPESWITCH

TECHNICAL DATA:

- VOLTAGE: 24 VAC or DC
- ACTUATION FORCE: 15 lbs nominal
- COLOR: Gray
- CURRENT RATING: 1 AMP
- MATERIAL: Molded PVC
- MOUNTING: 4 thru holes on 3/16" steel plate

PRICE	PART #	SIZE
\$107.05	TSCW517	5" W x 17" L
\$127.05	TSCW524	5" W x 24" L
\$131.76	TSCW532	5" W x 32" L

PRICE	PART #	SIZE
\$179.99	TSCW536	5" W x 36" L
\$265.96	TSCW548	5" W x 48" L
\$203.74	TSCW1024	10" W x 24" L



RAMPED FLOOR SWITCH

TAPESWITCH

TECHNICAL DATA:

- VOLTAGE: 24 VAC or DC
- ACTUATION FORCE: 15 lbs. nominal
- COLOR: Gray
- CURRENT RATING: 1 AMP
- MATERIAL: Molded PVC
- MOUNTING: 4 thru holes on 3/16" steel plate

PRICE	PART #	SIZE
\$151.28	TSCW916R	9" W x 16" L
\$168.36	TSCW924R	9" W x 24" L
\$181.78	TSCW932R	9" W x 32" L
\$244.00	TSCW936R	9" W x 36" L

PRICE	PART #	SIZE
\$257.42	TSCWR1424	14" W x 24" L - 24V



RBMA FLOOR SWITCH

TAPESWITCH

\$170.68	TSRBMA24	24" L	\$100.01	TSRBMA24RS	24" REPLACEMENT
\$194.68	TSRBMA36	36" L	\$116.01	TSRBMA36RS	36" REPLACEMENT

FEATURED PRODUCT

CHAR-LYNN MOTORS

Char-Lynn designs each motor for optimum performance. Each LSHT motor provides high-torque strength without the stress of fast-moving parts that can cause damage. They are excellent for conveyors that need power to move objects yet do not need to operate at a quick pace.



LOW SPEED

Motor start-up speed causes a spike in energy usage. Char-Lynn's low-speed design provides smooth operation at all times, from start-up to shut-down, to extend the life of the motor.

HIGH TORQUE

Char-Lynn hydraulic motors transform fluid energy into mechanical power. Power is the result of speed and torque, and high torque is required to start a load moving.

COMPACT & COST-EFFECTIVE

The LSHT motor eliminates the gearbox to save space and lower costs! Only three primary components are needed to transmit torque through the motor: starter, drive, and output shaft.

REVERSIBLE DESIGN

These motors let you reverse the direction of hydraulic fluid flow, without losing torque! Plus, the motors mount directly to the driven device.

GENERAL PURPOSE MOTORS

When choosing your motor, consider the following motor specs: pressure range, speed, torque, and fluid compatibility. You can shop for many popular models from the Char-Lynn H Series and S Series at Kleen-Rite.

H-SERIES MOTOR

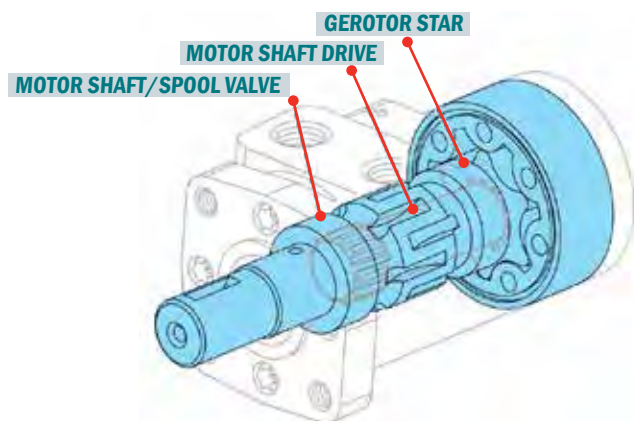

- Economical and compact
- Designed for medium duty applications
- Features an industry-proven spool valve design with state-of-the-art gerotors
- Gerotors offer fluid-tight sealing for leak-free performance. Great for conveyors and car wash brushes!
- Equipment can be driven direct to save costs

S-SERIES MOTOR

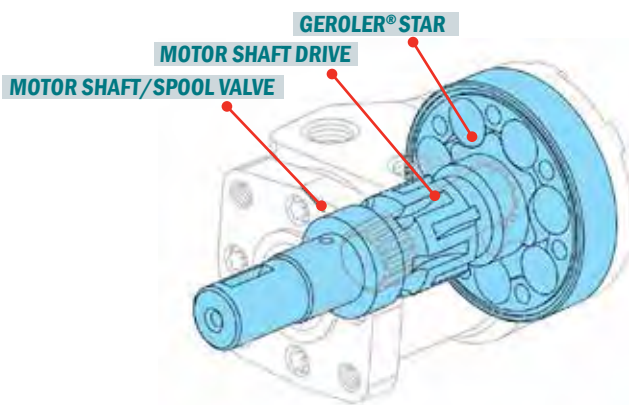

- An S-Series motor with a Geroler has a compact size and an optimized drive running angle to improve mechanical efficiency
- Within the Geroler, rollers provide support as the starter rotates. This minimizes friction and promotes efficiency, especially at start-up and low speeds
- Leak-free performance and smooth operation

FEATURED PRODUCT

CHAR-LYNN® MOTORS

H SERIES MOTOR

CHAR-LYNN MOTORS



CLP22000-2



CLP14193

- **MAXIMUM CASE PRESSURE:** 1500 PSI
- **MAXIMUM RECOMMENDED OPERATING TEMPERATURE:** 180°F
- **FLUID VISCOSITY:** Minimum viscosity at operating temperature should be the highest of the following: 10 SUS or (20 x PSI)/RPM=SUS
- **RECOMMENDED FLUIDS:** Premium quality, anti-wear type hydraulic fluid
- **RECOMMENDED FILTRATION:** Per ISO Cleanliness Code Level 18/13
- **RECOMMENDED BREAK-IN:** To assure best motor life, run motor for approximately one hour at 30% of rated pressure before application to full load. Be sure motor is filled with fluid prior to any load applications

PRICE	PART#	DESCRIPTION	DISPLACEMENT	RPM/3 GPM	RPM/6 GPM	RING SIZE	
\$309.52	CL101-1001-009	Motor, 1/4" Ring	2.8	235	471	1/4"	
\$318.07	CL101-1002-009	Motor, 3/8" Ring	4.5	150	296	3/8"	
\$327.46	CL101-1003-009	Motor, 1/2" Ring	5.9	115	230	1/2"	
\$380.77	CL101-1004-009	Motor, 7/8" Ring	9.7	70	140	7/8"	
\$395.01	CL101-1005-009	Motor, 1" Ring	11.3	60	120	1"	
\$389.04	CL101-1006-009	Motor, 1 1/4" Ring	14.1	48	95	1 1/4"	
\$411.28	CL101-1007-009	Motor, 1 1/2" Ring	17.9	38	75	1 1/2"	
\$449.74	CL101-1008-009	Motor 2" Ring	22.6	30	60	2"	
\$95.75	CLP22000-2	4 Bolt Mount Flange 009-010					
\$117.49	CLP22000-1	2 Bolt Mount Flange 009-010					
\$66.31	CLP60540	Seal Kit 009					
\$58.68	CLP60023	Seal Kit 007					
\$4.08	CLP14193	Woodruff Key, 1"					

S-PLUS MOTOR

CHAR-LYNN MOTORS



CLP60539

- **MAXIMUM RECOMMENDED OPERATING TEMP.:** 180°F
- **MAXIMUM CASE PRESSURE:** 1500 PSI
- **RECOMMENDED BREAK-IN:** To assure best motor life, run motor for approximately one hour at 30% of rated pressure before application to full load. Be sure motor is filled with fluid prior to any load applications
- **FLUID VISCOSITY:** 70 SUS at operating temperature
- **RECOMMENDED FLUIDS:** Premium quality, anti-wear type hydraulic fluid
- **RECOMMENDED FILTRATION:** Per ISO Cleanliness Code Level 18/13

PRICE	PART#	DESCRIPTION	DISPLACEMENT	RPM/3 GPM	RPM/6 GPM	RING SIZE	
\$308.78	CL103-1002-012	Motor, 3/8" Ring	4.5	146	293	3/8"	
\$472.00	CL103-1003-012	Motor, 1/2" Ring	5.9	112	225	1/2"	
\$499.36	CL103-1004-012	Motor, 7/8" Ring	9.7	68	136	7/8"	
\$512.17	CL103-1005-012	Motor, 1" Ring	11.3	58	117	1"	
\$603.13	CL103-1006-012	Motor, 1 1/4" Ring	14.1	47	95	1 1/4"	
\$601.09	CL103-1008-012	Motor, 2" Ring	22.6	30	60	2"	
\$95.75	CLP22000-2	4 Bolt Mount Flange 009-010					
\$117.49	CLP22000-1	2 Bolt Mount Flange 009-010					
\$69.40	CLP60539	Seal Kit 010					
\$56.45	CLP60533	Seal Kit 008					

FRONT FLANGE - 10,000 SERIES

CHAR-LYNN MOTORS



- 2 1/4" Shaft • 54.7 Cubic Inch Displacement

\$3,591.99 **CL119-1031-003**

2000 SERIES

CHAR-LYNN MOTORS

- 1 1/4" Keyed Shaft

PRICE	PART#	DESCRIPTION
\$738.83	CL104-1043-006	Motor, 18.7 cu"/ Rev
\$521.45	CL104-1025-006	Motor, 9.6 cu"/ Rev
\$95.54	CLP61258	Seal Kit 104 & 106

2000 SERIES

CHAR-LYNN MOTORS

PRICE	PART#	DESCRIPTION
\$617.13	CL106-1012-006	Motor, 11.9 cu"/ Rev
\$638.14	CL106-1013-006	Motor, 14.9 cu"/ Rev
\$656.86	CL106-1014-006	Motor, 18.7 cu"/ Rev
\$686.22	CL106-1015-006	Motor, 24 cu"/ Rev
\$95.54	CLP61258	Seal Kit 104 & 106
\$46.52	CLP61259	Buna Seal Kit

AUTOMATICS & TUNNELS

**STERLING
ELECTRIC, INC.**

STERLING MOTORS



MSE3005



MSE3020



MSE3030

MOTORS

STERLING ELECTRIC, INC.

- Sterling Electric produces a full range of electric motors to meet the most demanding applications found in today's industry. From standard duty applications to the harsh environments of the chemical industry or the washdown requirements of the food processing industry, Sterling Electric has the solution.

PRICE	PART #	VOLTAGE	HP	PHASE	RPM	ENCLOSURE	MOUNT
\$843.50	MSE3005	230/460	½	3	1800/1760 (full load)	TEFC	C-Face, Footless
\$494.99	MSE3010	230/460	1½	3	1800/1765 (full load)	TEFC	C-face supplied with internally locked drive end bearing
\$464.99	MSE3015	230/460	1	3	1800/1750 (full load)	TEFC	C-face supplied with internally locked drive end bearing
\$499.02	MSE3020	230/460	½	3	1800/1740 (full load)	TENV	C-Face, Footless
\$758.12	MSE3025	230/460	1	3	1800/1750 (full load)	TEFC	C-face supplied with internally locked drive end bearing
\$1,196.25	MSE3030	230/460	1	3	1800/1750 (full load)	TEFC	C-Face, Footless



PARKER MOTORS

TB & TC SERIES MOTORS

PARKER ROSS MOTORS



TC SERIES



TB SERIES

- Provides low-cost hydraulic power for medium to light duty applications
- Fully interchangeable with industry standards for porting, standard shafts & mountings
- Zero-leak commutation valve provides greater, more consistent, volumetric efficiency
- Full-flow lubrication maximizes cooling & extends motor life up to 50%
- Patented 60-40 spline member arrangement transmits more torque with less weight
- Full interchangeability with other motors - designed according to industry standards
- Unique high-pressure shaft seal - eliminates need for case drains
- Up to 13 HP output

PRICE	PART #	PARKER NUMBER	DISPLACEMENT	RPM	SHAFT	PORTS	MOUNT
\$388.50	PM1115	TB0195FP100AAAC	11.9 cu"/rev	287	1"	½" NPTF	4 Bolt
\$335.50	PM1150	TB0050FP100AAAC	3.0 cu"/rev	678	1"	½" NPTF	4 Bolt
\$336.99	PM1155	TB0065FP100AAAC	4.0 cu"/rev	511	1"	½" NPTF	4 Bolt
\$348.99	PM1175	TB0100FP100AAAC	6.0 cu"/rev	454	1"	½" NPTF	4 Bolt
\$409.50	PM1195	TB0230FP100AAAC	13.9 cu"/rev	246	1"	½" NPTF	4 Bolt
\$449.50	PM1225	TC0050FS100AAAC	3.0 cu"/rev	688	1"	¾" SAE	4 Bolt
\$705.10	PM1230	TE0230AS010AAAC	17.9 cu"/rev	328	1"	¾" SAE	2 Bolt

TORQMOTOR TE SERIES

PARKER ROSS MOTORS

- Reliable performance for light duty applications at your wash facility. Durable construction with continuous oil flow for extended service life and great side load capacity and smooth, hassle-free operation. Unique design eliminates the need of a case drain.
- 1" Keyed • Mounting: 4 Bolt w/ ¾"-16 UNC • Ports: ¾"-14 SAE

PRICE	PART #	PARKER NUMBER	DISPLACEMENT	RPM	LENGTH
\$622.99	PM1255	TE0195FS100AAC	4 cu"/rev	292	140 mm (5.51")
\$335.50	PM1150	TB0050FP100AAAC	11.9 cu"/rev	1020	165.42 mm (6.51")

AUTOMATICS & TUNNELS

LUBRICANTS, SEALANTS & ANTI-SEIZE



CARTRIDGE



AEROSOL



CANISTER



OILER

SUPER LUBE® AUTOMATICS SUPPLIES

- "EVERYWHERE AND NO WEAR!"
- Super Lube lasts longer and outperforms conventional petroleum-based greases and oils. It comes in grease form, a 90-140 weight gear oil and 10W light-weight oil.

PRICE	PART #	DESCRIPTION
\$6.67	SL21030	3 oz. Grease
\$7.52	SL21036	3 oz. Cartridge of Grease
\$8.58	SL31040	6 oz. Aerosol
\$9.89	SL31110	11 oz. Aerosol
\$14.54	SL41150	400 gram Cartridge of Grease
\$4.68	SL51010	7 ml Precision Oiler



JL47102



JL35050



JL33050



JL37341



JL34041



JL73560



JL32460

JET LUBE® ANTI-SEIZE, SEALANTS & LUBRICATIONS

AUTOMATICS SUPPLIES

\$26.85	JL47102	550 EXTREME ANTI-SEIZE LUBRICANT WITH BRUSH TOP 1 LB. - Enhanced rust and corrosion resistance. Lead free. Protects against seizure, heat-freeze, galling, rust and corrosion. Lowers friction, reduces wrench torque. Provides easy makeup and breakout. Reduces maintenance costs. Not affected by contraction, expansion, or vibration.
\$14.01	JL35050	ARCTIC LOW-TEMPERATURE GREASE CARTRIDGE 14 OZ. - Designed for extreme cold weather environments where fluid film strength is important and grease consistency remains the same. It is ideally suited for applications that experience working environments at subzero climates.
\$16.53	JL33050	202 MOLY-LITH MULTI-PURPOSE GREASE CARTRIDGE 14 OZ. - Excellent for rack/pinion grease cups, drive shaft idler arm and ball joints. Specifically formulated to protect your equipment from premature damages that can occur from dirt, dust, and sediments.
\$17.97	JL37341	769 LUBRICANT AEROSOL 12 OZ. - unique in that it lifts and displaces moisture, rather than trapping it. Pores and crevices of surfaces are freed from moisture and are coated with a thin non-greasy film that prevents additional moisture from clinging or entering.
\$18.99	JL34041	WRL WIRE ROPE & CHAIN LUBRICANT AEROSOL 12 OZ. - quickly penetrates wire rope and cable to the core and builds a shield against offshore weathering conditions. It's highly resistant to rain and salt water atmospheres and is a water displacing spray and lubricant.
\$31.93	JL73560	SILICONE COMPOUND DM 5 OZ. - Dielectric, translucent paste that provides excellent lubrication and sealing properties for plug and gate valves, stuffing boxes, o-rings, vacuum and pressure systems.
\$29.00	JL32460	5.30Z MP SILICONE GREASE - Designed compatibility for O-ring materials including Buna-N, Viton, HSN, Teflon, nitrile, and nylon. Ideally suited as an insulator for electrical connectors against the elements.

AUTOMATICS & TUNNELS

CAR WASH TANKS



SINGLE FUNCTION WALL MOUNT PANEL FOR AUTOMATICS EQUIPMENT

- 14" x 32" Stainless Steel Wall Mount Panel
- (1) Stainless Steel Tank
- (1) Santo FloJet Pump
- (1) 506 Hydrominder
- (1) Air Regulator / Gauge

CALL LPS1AUTO



TRIPLE FOAM WALL MOUNT PANEL FOR AUTOMATICS EQUIPMENT

- (2) Stainless Steel Wall Mount Panels
- (3) Stainless Steel Tanks
- (3) Santo FloJet Pumps
- (3) 506 Hydrominders
- Pre-plumbed & wired with solenoids and regulators

\$2,139.13 LPS3AUTO



DOUBLE FUNCTION WALL MOUNT PANEL FOR AUTOMATICS EQUIPMENT

- 14" x 32" Stainless Steel Wall Mount Panel
- (2) Stainless Steel Tanks
- (2) Santo FloJet Pumps
- (2) 506 Hydrominders
- (2) Air Regulator / Gauges

CALL LPS2AUTO



<https://airlogiccarwash.com/>



TA0130 24" x 24" x 12"



TA0224 12" x 6" x 10"

STAINLESS STEEL WALL TANK

MOUNTED TANKS

- Available in single, double, & triple
- 3/4" outlet fitting
- Wall mounting brackets attached to tank
- **SHOWN WITH BRACKET, ALL PARTS SOLD SEPARATELY**

\$419.89	TA0160	Single Tank
\$527.91	TA0110	Double Tank
\$652.05	TA0130	Triple Tank
\$177.58	TA0224	Stainless Steel Wall Tank
\$46.69	TA0224B	Stainless Steel Bracket
\$29.74	TA0224L	Lid Only for Tank



FOAM GENERATORS



EASY CLEAN CAR WASH FOAM GENERATOR

NEW WAVE INNOVATIONS, INC.

- The easy clean generator is a revolutionary foam generator that takes the trouble out of cleaning your chemical application foam generators - no tools needed since there are no fittings to take apart or any air and chemical lines to disconnect!
- The media is made up of two types: one that mixes and one that foams
- No need for the needle valve or check valves because the media is suspended to the twist off cap so that the media does not compress in the foam chambers, creating unpredictable back-pressure and flow resistance
- Installation is a snap - each unit comes with direct fit air and chemical fittings and outlet sizes to fit your applicators
- Cleans in seconds, not minutes
- Uses less chemical to create a dramatic show of foam, color and scent that your customers will love!
- Reduce expenses in labor, water and chemicals!

GENERATOR

INSERT

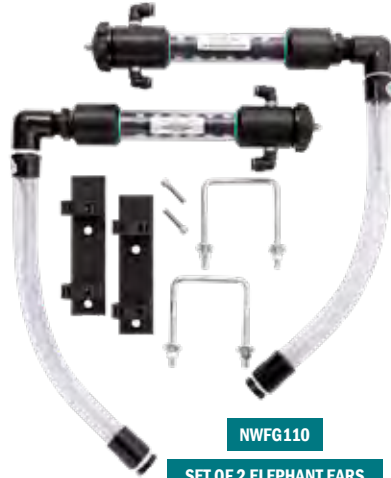

NWFG110

SET OF 2 ELEPHANT EARS

10" BAY FOAM GENERATOR FOR SELF SERVE BAYS

NEW WAVE INNOVATIONS, INC.

COMES STANDARD WITH:

- 3/4" female output fitting
- 3/8" air push lock fitting
- 1/2" chemical push lock fitting
- 4" square mount

\$142.61	NWFG105	10" Foam Generator
\$42.49	NWFG105-I	Insert for 10" Foam Generator

16" EASY CLEAN GENERATOR FOR TUNNEL APPLICATIONS

NEW WAVE INNOVATIONS, INC.

COMES STANDARD WITH:

- 1" male output fitting
- 3/8" air push lock fitting
- 1/2" chemical push lock fitting

\$173.41	NWFG100	16" Foam Generator
\$41.62	NWFG100-I	Insert for 16" Foam Generator

ELEPHANT EAR FOAMER PARTS & ACCESSORIES

NEW WAVE INNOVATIONS, INC.

\$49.47	NWFG-M	Mount for Foam Generator
\$618.72	NWFG110	Elephant Ear Foamer (Set of 2)
\$310.60	NWFG115	Single Elephant Ear Foamer

\$100.02	NWFG110-FT	Foam tube for Elephant Ear Foamer
\$45.84	NWFG110-MK	Mounting Kit for Elephant Ear Foamer

TOP STICK TRIPLE SET WITH GENERATORS AND MOUNTING

NEW WAVE INNOVATIONS, INC.

- Triple top stick foamer kit for tunnel car washes. Molded design for improved dispensing, provides consistent performance out of a compact design that offers great clearance for vehicles. Delivers broad coverage for even the widest trucks and SUVs.
- Includes: 3 stick foamers, generators, and mounting kit for easy installation

\$977.32	NWFG120-3
-----------------	------------------

CYCLONE 1-3 COLOR RAIN ROPE RIBBON APPLICATOR

NEW WAVE INNOVATIONS, INC.

- Creates rope-like droplets onto the vehicle for a great show! Mounting system allows for the mounting of additional applicators or lights in conjunction with the Cyclone for a comprehensive, easy-to-service unit that can be added and removed as needed
- Mount vertically or horizontally
- Mix & match - dispense up to six different colors of product! | Use with presoak, wax, and more!

\$1,239.33	CYCLONE
-------------------	----------------

FLAT MOUNT BOOMERANG FOAMING UNITS

TSS



- Effective and flexible foamer made out of chemical resistant HDPE and stainless steel bolts
- Flat mounting base facilitates easy installation anywhere you see fit within your wash area
- Features foam generators that optimize chemical performance and consistency by using two types of foaming media

SPECIFICATIONS:

- 3/8" Air Intake | 1/2" Solution Intake | Minimum Flow Rate of 6 GPM @ 40 PSI | Built-in Check Valve

\$692.39	TSSBFB2	Single set of two boomerang foamers (two units total)
\$1,834.55	TSSBFB3	Triple set of boomerang foamer units (six units total)



TSSBFB2

TSSBFB3

AUTOMATICS & TUNNELS

VALVES & AIR CYLINDERS

LEXAIR AIR OPERATED SHUT OFF VALVE & REPAIR KIT

LEXAIR, INC.



- For use in high pressure lines and change over between spray arch and underbody on PDQ LaserWash 4000
- 1" FPT port connection | Pressure rating 1000 PSI | Direct pilot operated normally open valve
- Valves feature a large resilient poppet that provides bubble-tight closure, even under low pressure conditions
- Internal components made from bronze, brass and stainless steel
- Pilot cap is easily removed for quick access to the valve's one-piece poppet assembly
- O-ring on poppet and U-cup pilot piston seal prevent controlled and pilot media from mixing permitting use of different media for pilot/control
- Incorporate a single, direct operated poppet design

\$485.19	LX4136202	Valve
\$139.71	LX4136002	Repair Kit



DANFOSS VALVES

DANFOSS



3/8" SOLENOID VALVE (LESS COIL)

DANFOSS

\$64.90	DF06LC	For Type EVS16
\$23.93	DF06LCK	Repair Kit

1/2" SOLENOID VALVE (LESS COIL)

DANFOSS

\$53.40	DF08LC
----------------	---------------

- Direct servo-operated 2/2-way solenoid valve.
- **CALL OR VISIT OUR VALVES & SWIVELS SECTION FOR MORE OPTIONS!**



NFPA AIR CYLINDERS

IR ARO



- **NO CORROSION - IDEAL FOR CAR WASH APPLICATIONS**
- Tie bolt construction eliminates rod binding and tie rod torque problems
- Rugged thick walled tubes resist denting.
- NFPA repairable and interchangeable.
- Factory lubricated grease that will not wash out.
- Operates on air pressure up to 250 psi
- Output forces up to 19,635 lbs. (10" bore at 250 psi).
- Std. operating temp: 0 degrees to 185°F, -18° to 82°C).
- Viton seals for high heat applications (up to 300°F, 149°C)

PRICE	PART	ARO MODEL	DESCRIPTION	SPECS.
\$199.81	AC1040	ANAQK-ABXAD-080	ARO CLEVIS Mount Cylinder	1 1/2" Bore X 8" Stroke
\$259.14	AC1050	ANAQK-ABXAD-120	ARO CLEVIS Mount Cylinder	1 1/2" Bore X 12" Stroke
\$147.75	AC1060	ANAQK-CBXAC-044	ARO CLEVIS Mount Cylinder	1 1/2" Bore X 4 1/2" Stroke

SIMONIZ® PAD PERFECT™ REPLACEMENT PARTS



SIMONIZ® PAD PERFECT™

SIMONIZ AUTOMATICS



\$192.98	PA5220	Pad Perfect 5 Gallons
\$1,116.20	DR30264	30 Gallons
\$1,858.04	DR55264	55 Gallons
\$283.60	SMTS200	C-Style Concave Pads/Rails Set of 4

LOOP DETECTORS & ACCESSORIES



SP-24 SURFACE MOUNTED LOOP PAD EMX INDUSTRIES, INC.

- The SP-24 Surface Mounted Loop Pad is designed for use with EMX loop detectors
- Size: 23³/₄" x 23³/₄" x 1"
- Material: black polypropylene
- Lead-In: 50 feet shielded twisted pair
- SP-24 Lead-In Guard: 24" x 3" x 1/2" and also made out of black polypropylene

\$574.45	EMSP24	Loop Pad
\$607.83	EMSP24-100	Loop Pad W/ 100' Lead



PREFORMED LOOP EMX INDUSTRIES, INC.

- With 50' lead

\$153.94	EMPR26	2' x 6'
\$149.64	DMLLOOP	4' x 6'
\$161.57	EMPR48	4' x 8'



11 PIN ACCESSORIES EMX INDUSTRIES, INC.

- 11 pin with 3' of wire
- Base for DIN rail mount

\$13.67	EMHAR11	Harness
\$11.44	EMBASE	Socket

New!



UNIVERSAL THRU BEAM PHOTOEYE KIT EMX INDUSTRIES, INC.

- Able to operate up to 115 feet and is compatible with a wide range of input voltages. The photoeye provides a signal to the gate or door operator that the beam is, or is not obstructed.
- **OPERATING RANGE:** 5 to 155 ft.
- **MAX VOLTAGE AC:** 24
- **MAX VOLTAGE DC:** 35
- **MIN TEMP:** -40 F
- **MAX TEMP:** 170 F
- **CONDUIT HOLE SIZE:** 1/2" NPT

\$183.66	EMIRB-MON2
-----------------	-------------------



New!

RETROREFLECTIVE PHOTOEYE KIT EMX INDUSTRIES, INC.

- Delivers exceptional compatibility with a wide range of gate openers
- Type B1 Non-Contact Sensor
- Universal Mounting Bracket
- **MAX RANGE:** 60 feet
- **SENSITIVITY ADJUSTMENT:** Potentiometer

\$190.84	EMIRB-RET2
-----------------	-------------------



LOOP-LESS ULTRASONIC VEHICLE DETECTOR EMX INDUSTRIES, INC.

- Installs easily above ground - just aim to detect
- 4 ultrasonic sensing elements
- Operating range: 1' to 5'
- 2 relay output
- Ideal for fast food, parking, banking, pharmacy, and carwash drive-thru operations

\$287.42	EMUSVD-4X
-----------------	------------------



ULTRALOOP MUTLI-VOLTAGE VEHICLE DETECTOR EMX INDUSTRIES, INC.

- Universal input range: 12 VDC to 240 VAC
- Small size: 73 x 38 x 78mm
- 10 sensitivity adjustments
- 4 frequency settings
- ULTRAMETER display indicates the appropriate sensitivity setting for vehicle on loop
- DETECT-ON-STOP technology distinguishes between moving and stopped vehicles

\$151.88	EMDTEK-ULTMVP
-----------------	----------------------



MULTI-VOLTAGE VEHICLE DETECTOR EMX INDUSTRIES, INC.

- Universal Input Range: 12V to 240V AC/DC
- Loop diagnostics, isolation transformer, conditioner
- Aluminum RF shield housing
- Loop frequency counter
- 10 gold plated sensitivity controls
- 8 gold plated function controls
- 6 gold plated controls for frequency, reset & counter
- 2 High intensity LED indicators
- 2 relays pulse or presence

\$119.10	EMDTEK-MVP
-----------------	-------------------



LOW POWER VEHICLE DETECTOR EMX INDUSTRIES, INC.

- 2 relays
- LED indicators
- Requires 12-24V AC/DC power supply
- Only draws up to 9 mA current
- 3, 6, & 9 second extend direct output controls
- Fail safe detection modes
- Surge protection and loop isolation transformer
- Loop diagnostics and built-in loop conditioner
- Extrudend anodized aluminum RF shield housing
- Frequency counter
- Circular 11 pin connector
- 4 minute limit control

\$111.36	EMDTEK-LP
-----------------	------------------

AUTOMATICS & TUNNELS



LOOP DETECTORS & ACCESSORIES

FLAT PACK VEHICLE SENSOR

EMX INDUSTRIES, INC.



- Housing: Polyamide
- Outputs: NPN - open collector
- Connection: 5 conductor
- Operating environment: -40° F..180° F)
0...95% relative humidity
- Environmental rating: IP69K
- Power supply: 12-30 VDC
- Current draw: 10 mA max
- Dimensions: 4.3" x .9" x .3"
- 50' long lead
- Use with the LRS-C1 Controller
- Purchase as a kit that includes both the sensor and controller (part #LRS-FP-50-K)
- Direct Burial Sensor also available (part #LRS-DB-50)

\$165.32 LRS-FP-50

DIRECT BURIAL VEHICLE SENSOR FOR LRS

EMX INDUSTRIES, INC.



- Housing: PVC
- Outputs: NPN - open collector
- Connection: 5 conductor
- Environmental rating: IP69K
- Power supply: 12-30 VDC
- Current draw: 10 mA max
- Dimensions: 4" x 1"
- 50' long lead
- Use with the LRS-C1 Controller
- Purchase as a kit that includes both the sensor and controller (part #LRS-DB-50-K)
- Flat Pack Sensor also available (part #LRS-FP-50)

\$174.78 LRS-DB-50

LOGIC CONTROLLER FOR LRS

EMX INDUSTRIES, INC.



- Power indicator: Green LED
- Detect indicator: 2 Red LEDs
- Configuration selector: 10 position rotary switch
- Dimensions: 2.9" x 1.2" x 3.1"
- Connector: 11 pin male connector (JEDEC B11-88)
- Two relay operation
- A/B directional logic
- Pulse on entry and on exit
- Relay 1 only

\$121.90 LRS-LC

CONTROLLER FOR LOOP REPLACEMENT SYSTEM (LRS)

EMX INDUSTRIES, INC.



- Housing: ABS plastic
- Dimensions: 3" x .9" x 2.75"
- Outputs: SPDT relay
- Power: 12-30 VDC and 24 VAC
- Output current rating relay: 1 A @ 24-120 VDC
- Current draw: 40 mA (max)
- Supply protection: Reverse polarity and fuse protected
- Use with the Flat Pack Sensor (part #LRS-FP-50) or Direct Burial Sensor (part #LRS-DB-50)
- Available as kits that include a controller and sensor (LRS-FP-50-K or LRS-DB-50-K)

\$115.77 LRS-C1



OVERHEAD MICROWAVE MOTION SENSOR HUMAN/VEHICLE DISCRIMINATION

EMX INDUSTRIES, INC.

- Operating frequency: 24.150 GHz
- Detection range: Maximum detection range of 23' x 23' at an installation height of 16'. and a housing angle of 45° (dependent on sensor height and housing angle)
- Mounting height: 8-23 ft (2.5-7 m)
- Power: 12-36 VDC or 12-28 VAC
- Dimensions: With bracket - 5.16" x 2.87" x 5.35"
- Connection: 26' (8m) cable

\$378.57 RAVEN

(LRS) VEHICLE DETECTION KIT-CONTROLLER AND FLAT PACK SENSOR

EMX INDUSTRIES, INC.



- Sensing technology: 3-axis magnetoresistive
- ULTRAMETER display: 10 levels of sensitivity: 0-9
- Axis sensitivity: 512 counts/gauss (typical)
- Detect-on-step: Requires vehicle to stop for a minimum of 1 second (1-2s typical)
- Power supply: 12-30 VDC and 24 VAC (controller), 12-30 VDC (sensor)
- DETECT-ON-STOP™ (DOS®) feature will allow detection only when a vehicle has come to a complete stop near the sensor. This EMX exclusive technology ignores cross traffic in tight spaces
- Flat Pack Sensor (part #LRS-FP-50) and LRS Controller (part #LRS-C1) available separately
- Dimensions: 3" x .9" x 2.75" (controller), 4.3" x .9" x .3" (sensor)

\$283.60 LRS-FP-50-K

(LRS) VEHICLE DETECTION KIT-CONTROLLER AND DIRECT BURIAL SENSOR

EMX INDUSTRIES, INC.



- Sensing technology: 3-axis magnetoresistive
- ULTRAMETER display: 10 levels of sensitivity: 0-9
- Axis sensitivity: 512 counts/gauss (typical)
- Power supply: 12-30 VDC and 24 VAC (controller), 12-30 VDC (sensor)
- Control module for programming and relay contact output
- Stand-alone sensor stores background and settings in a non-volatile memory
- DETECT-ON-STOP™ (DOS®) feature will allow detection only when a vehicle has come to a complete stop near the sensor. Exclusive technology ignores cross traffic in tight spaces
- Direct Burial Sensor (part #LRS-DB-50) and LRS Controller (part #LRS-C1) available separately
- Dimensions: 3" x .9" x 2.75" (controller), 4" x 1" (sensor)

\$291.92 LRS-DB-50-K

AUTOMATICS & TUNNELS



UNDERCARRIAGE & TIRE CLEANERS

STATIONARY UNDERCARRIAGE CLEANER

MOSMATI

- The TUW stationary is perfect for fixed ramp over or sub-floor undercarriage wash systems. Industrial grade stainless steel plates and boxes come complete with quad bearing swivels and welded balanced rotor arms. The high lift design removes heavy debris and cleans without damage to the vehicles undercarriage
- Compact solid construction • Equipped with nozzle stabilizers
- Modular Design • Requires 4x EG-nozzles, according to your pump specifications
- **PRESSURE:** 4000 PSI • **MAX. TEMP:** 250°F
- **MAX. RPM:** 2000 • **WATER CONNECTION:** 3/4" NPTF
- **WATER DRAIN:** 1" NPTF • **THROUGHPUT MEDIUM:** pH 3-12
- **SWIVEL:** 2x DYT • **ROTOR ARM:** 8"/10"
- **STAB. NOZZLE/ADAPTER:** 4x 14.901 • **DIMENSIONS:** 29½" x 11.8" x 10.8"
- **WEIGHT:** 70.5 lbs

CALL UCM80640

ADDING UNDERCARRIAGE CLEANING TO YOUR WASH INCREASES REVENUE!

Customers want to protect their vehicles from drainage problems due to debris and oil buildup, salt corrosion and more. Adding an undercarriage cleaning option to your bays or a stationary undercarriage cleaner to your automatics will keep your customers happy and your wallet full!

WHEELBLASTER PRO

MOSMATIC

- Polished stainless steel • Equipped with stabilizer nozzle
- Seamless height and angle adjustable • Multiple cleaning heads can be installed
- High impact at a distance
- **PRESSURE:** 4000 PSI • **MAX. TEMP:** 250°F
- **MAX. RPM:** 2000 • **WATER CONNECTION:** ¾" NPTF
- **THROUGHPUT MEDIUM:** pH 3-12

CALL SWMTA84546

TIRE CLEANER WITH 21" STAINLESS STEEL HOUSING

MOSMATIC

- The water pressure makes the rotor arm begin to turn on its own. The design is constructed so simply that any maintenance work can be carried out independently and very quickly. These products are found mainly in automatic car wash facilities in the area of rim/tire cleaning and lateral finish cleaning. It is an efficient and reliable method of achieving optimal cleaning results.

CALL

SWMTC84519

High performance (DYT) Swivel, 18½" / 14" Spinner

SWMTC84504

Standard (DYF) Swivel, 16" / 10" Spinner

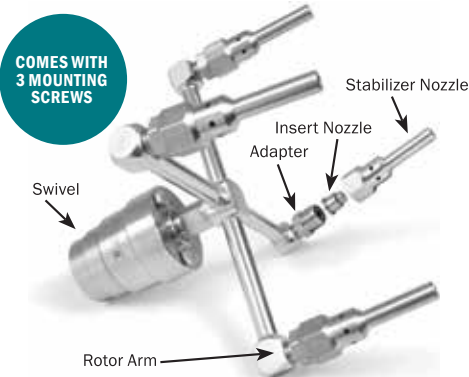
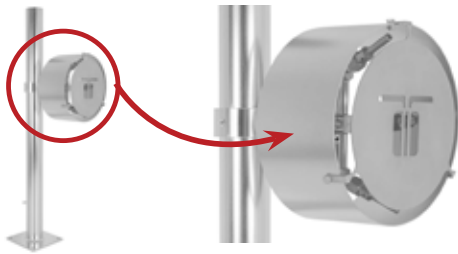

ROTATION SYSTEM

MOSMATIC

- As the water pressure builds, the rotor arms begin to rotate independently. The arm rotates only by the force of the water jet and requires no other power. A simple but efficient and solid product for optimal cleaning effect.
- Max. Pressure - 5000 PSI • Max. Temp. - 250°F • Stab. Nozzle / Adapter (4) 14.901

PRICE	PART #	G1 (F)	NW	ROTARY UNION	ROTOR ARM	INSERT NOZZLE
CALL	SWMT81920	¼" NPTF	¼"	DYT (59.063)	4w4 (82.954)	(4)0004EG
	SWMT81922	¾" NPTF	¼"	DYT (59.163)	4w4 (82.954)	(4)0004EG

AUTOMATICS & TUNNELS

Proto-Vest Dryers

PROTO-VEST DRYERS



WINDSHEAR



S130



SIDESHOT



T130



T260



DIABLO

Update your existing dryer arch with directed air flow for Macneil, Peco and others (*dryer not included)

DRYERS

PROTO-VEST DRYERS

CALL FOR PRICING

PROTO-VEST DRYERS will improve the efficiency and profitability of any type of car wash including In bay, roll over and tunnel operations. PROTOVEST DRYERS provide the lowest energy usage and noise levels in the industry that save money for the wash operators.

FEATURES & BENEFITS:

- Constructed using Aircraft Grade Aluminum
- Unmatched Energy Efficiency
- LOW Maintenance
- Touchless Drying Directed Air Flow
- Patented Proto-Duck™ Air Deployment Bags
- Steel Blower Assemblies
- Easy to Install

COLOR CHOICES



BLACK



RED



BLUE



GREEN

ACTUAL COLOR MAY VARY FROM PICTURES SHOWN.

CUSTOM COLORS ALSO AVAILABLE UPON REQUEST.

DRYING PERFORMANCE IS AFFECTED BY THE FOLLOWING:

- 1 If the car is not clean;
- 2 Use of RO water without drying agent;
- 3 If cleaning agents are not properly balanced;
- 4 Insufficient rinsing (soap on vehicle);
- 5 Inadequate balance between rinse water & drying agent;
- 6 Excessive drive through speed.



PLEASE NOTE WHEN PURCHASING:

- Wiring and Controls to be provided by the purchaser
- Additional motor specifications available on request
- Additional Motor votages available on special order
- Install not included



SILENCER PACKAGE

PROTO-VEST DRYERS

- Above decibel readings are interpolated from T260 Dryer with 2 of the 30 Hp Motors

WITHOUT SILENCER

10 ft = 94 dBa
20 ft = 88 dBa

WITH SILENCER

10 ft = 88 dBa
20 ft = 82 dBa



AIRGATE

PROTO-VEST DRYERS

- Reduce start up power consumption and prolong dryer motor life

AUTOMATICS & TUNNELS

Universal Brush

TIRE BRUSHES

POODLE 96" x 12"/6" DIAMETER

4 BOLT ADAPTER

WELDED SHAFT



POODLE TIRE BRUSHES 96" LONG X ALTERNATING 12"/6" DIAMETER

UNIVERSAL BRUSH

MOUNTING: 4-BOLT ADAPTER		
PRICE	PART #	COLOR
\$1,051.74	UB500BK	Black
\$1,051.74	UB500BL	Blue
\$1,051.74	UB500R	Red

MOUNTING: WELDED SHAFT		
PRICE	PART #	COLOR
\$1,131.33	UB502BK	Black
\$1,131.33	UB502BL	Blue
\$1,131.33	UB502R	Red



TIRE DRESSING BRUSHES

UNIVERSAL BRUSH

MOUNTING: 4-BOLT ADAPTER		
PRICE	PART #	COLOR
\$1,017.62	UB520BK	Black

MOUNTING: WELDED SHAFT		
PRICE	PART #	COLOR
\$1,097.22	UB522BK	Black

STANDARD TIRE BRUSHES - 96" LONG x 8" DIAMETER

UNIVERSAL BRUSH



4 BOLT ADAPTER

NYLON/POLY MIX		
MOUNTING: 4-BOLT ADAPTER		
PRICE	PART #	COLOR
\$977.82	UB504BK	Black
\$977.82	UB504BL	Blue
\$977.82	UB504R	Red

MOUNTING: WELDED SHAFT		
PRICE	PART #	COLOR
\$1,051.73	UB506BK	Black
\$1,051.73	UB506BL	Blue
\$1,051.73	UB506R	Red

POLY		
MOUNTING: 4-BOLT ADAPTER		
PRICE	PART #	COLOR
\$824.34	UB508BK	Black
\$824.34	UB508BL	Blue
\$824.34	UB508R	Red

MOUNTING: WELDED SHAFT		
PRICE	PART #	COLOR
\$903.93	UB510BK	Black
\$903.93	UB510BL	Blue
\$903.93	UB510R	Red

NYLON		
MOUNTING: 4-BOLT ADAPTER		
PRICE	PART #	COLOR
\$1,449.69	UB512BK	Black

MOUNTING: WELDED SHAFT		
PRICE	PART #	COLOR
\$1,534.95	UB514BK	Black



CLOTH TIRE BRUSHES

UNIVERSAL BRUSH

MOUNTING: 4-BOLT ADAPTER		
PRICE	PART #	COLOR
\$1,131.33	UB516BK	Black
\$1,131.33	UB516BL	Blue
\$1,131.33	UB516R	Red

MOUNTING: WELDED SHAFT		
PRICE	PART #	COLOR
\$994.88	UB518BK	Black
\$1,205.24	UB518BL	Blue
\$1,205.24	UB518R	Red



4 BOLT SPINDLE

UNIVERSAL BRUSH

- For tire brush/poodle/wheel applicator - HANNA, Sonny's, Peco
- 4½" long
- Available with 4 bolt mount or keyed shaft or custom.
- 1¼" shaft down to 1" with key

\$94.12	UBA42016
---------	----------

WHEEL WONDER

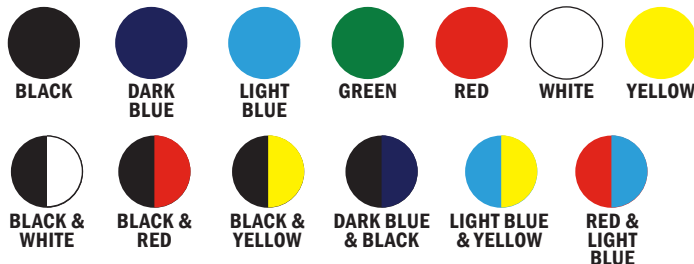

ERIE WHEEL WONDER®

ERIE BRUSH



- Boasts constant full contact with the wheel. The washing material can be premium filaments or Erie's Supreme Cloth.
- 96" in length or longer recommended - 18" major diameter recommended
- Dynamically balanced with solid, precise construction.
- Available with 4 bolt mount or keyed shaft or custom.
- MADE TO YOUR SPECIFICATION

\$1,462.89	EB127100	With Bolt Mount
\$1,510.81	EB127100S	With Shaft Ends

BEFORE ORDERING, PLEASE NOTE THE FOLLOWING:

- What are the measurements of your brush equipment?
- Who manufactures your equipment?
- What is the overall length and diameter?
- Is the shaft bolted or welded? If welded, what is the shaft length and diameter?

PLEASE SPECIFY COLOR & 4-BOLT MOUNT OR SHAFT WHEN ORDERING

ALL PRICES ARE F.O.B. AND ARE SUBJECT TO CHANGE WITHOUT NOTICE • NO C.O.D.'S

1-800-233-3873 • (717) 684-6721 • FAX (800) 446-0495 • KLEENRITE.COM

567

AUTOMATICS & TUNNELS

REPLACEMENT CLOTH & FOAM

KLEEN-RITE CORP. INTRODUCES FIVE STAR CARWASH CLOTH AND FIVE STAR FOAM.

This top of the line cloth is extremely durable and comes in four vibrant colors that are guaranteed not to fade prematurely.

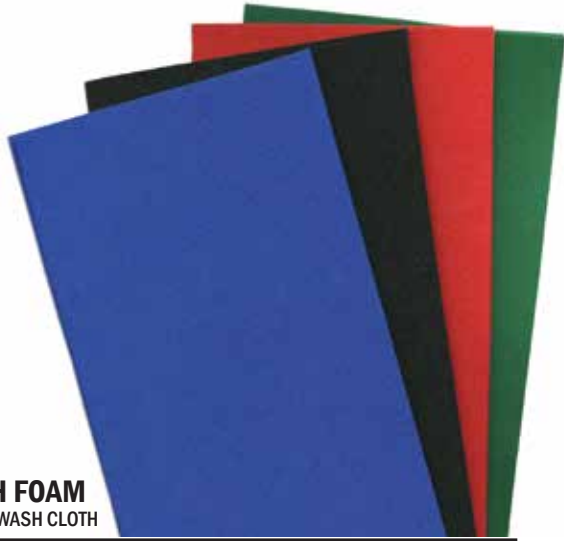

CAR WASH FOAM
FIVE STAR CAR WASH CLOTH

- Five Star Carwash Foam has the softest, most gentle touch. Five Star Foam Washing Material is lightweight, yet has tremendous tensile strength. The foam comes in 4 vibrant colors and is a great value.



CAR WASH CLOTH
FIVE STAR CAR WASH CLOTH

- Five Star Carwash Cloth has a soft and gentle touch while also being extremely durable. Five Star Cloth color's last and last, the color remains bright and vibrant throughout it's life. The cloth is also designed to hold more soap and water, resulting in cleaner vehicles.

HOW TO ORDER KLEEN-RITE'S 5 STAR CLOTH & FOAM

FOAM AND CLOTH AVAILABLE IN THE FOLLOWING COLORS: ● ● ● ●

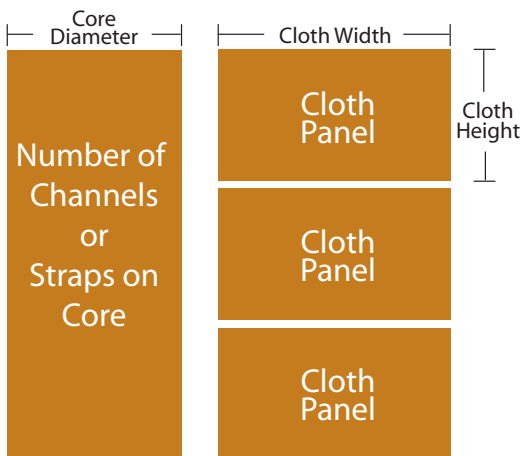

FOR CLOTH & FOAM REPLACEMENT

FIVE STAR CAR WASH CLOTH

- Measure cloth width & height.
- Measure slit size (1/2", 1", 2").
- Indicate if cloth is 1-ply or 2-ply.
- Indicate the number of pieces.

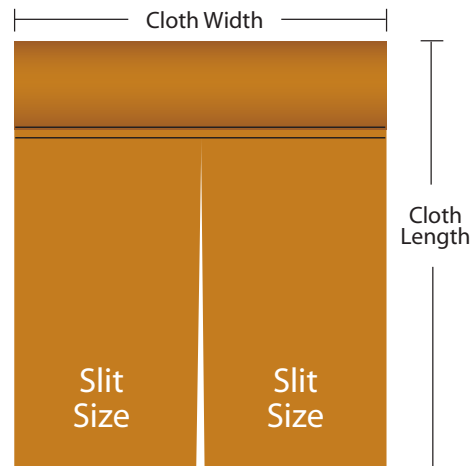

FOR MITTER CLOTH

FIVE STAR CAR WASH CLOTH

- Indicate if cloth has attached plastic rod, looped & sewn, or clip on/nylon tie style
- Measure cloth width & length.
- Measure slit size (2", 3", 4", 6").
- Indicate the number of pieces



REPLACEMENT CLOTH & FOAM- BELANGER® MODELS

FOAM AND CLOTH AVAILABLE IN THE FOLLOWING COLORS: ● ● ● ●

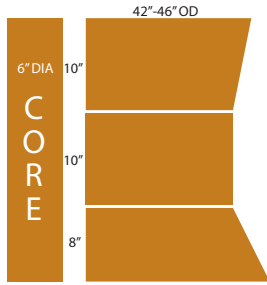

MODEL 2001 & 2x2
DRIVER SIDE 28" HIGH CORE
FIVE STAR CAR WASH FOR BELANGER

- 6" Diameter core
- 28 Channels x 28" high
- **CLOTH REPLACEMENT**
- 28 pcs: 10" x 18"/16"
- 28 pcs: 10" x 16"
- 28 pcs: 8" x 16"/20"

PRICE	PART#	MATERIAL	COLOR
\$543.49	UBC100BL	Cloth	Blue
\$543.49	UBC100BK	Cloth	Black
\$543.49	UBC100R	Cloth	Red
\$543.49	UBC100G	Cloth	Green
\$750.42	UBF100BL	Foam	Blue
\$750.42	UBF100BK	Foam	Black
\$750.42	UBF100R	Foam	Red
\$750.42	UBF100G	Foam	Green

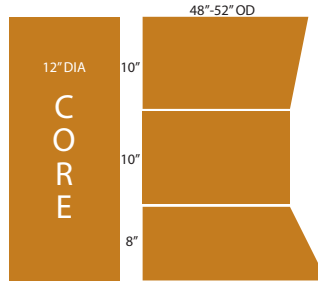

MODEL 2001 & 2x2
PASSENGER SIDE 28" HIGH CORE
FIVE STAR CAR WASH FOR BELANGER

- 12" Diameter core
- 44 Channels x 28" high
- **CLOTH REPLACEMENT**
- 44 pcs: 10" x 18"/16"
- 44 pcs: 10" x 16"
- 44 pcs: 8" x 16"/20"

PRICE	PART#	MATERIAL	COLOR
\$855.02	UBC105BL	Cloth	Blue
\$855.02	UBC105BK	Cloth	Black
\$855.02	UBC105R	Cloth	Red
\$855.02	UBC105G	Cloth	Green
\$1,173.39	UBF105BL	Foam	Blue
\$1,173.39	UBF105BK	Foam	Black
\$1,173.39	UBF105R	Foam	Red
\$1,173.39	UBF105G	Foam	Green

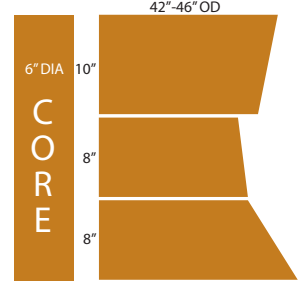

MODEL 2x2
DRIVER SIDE 26" HIGH CORE
FIVE STAR CAR WASH FOR BELANGER

- 6" Diameter core
- 28 Channels x 26" high
- **CLOTH REPLACEMENT**
- 28 pcs: 10" x 18"/14"
- 28 pcs: 8" x 14"/15"
- 28 pcs: 8" x 15"/20"

PRICE	PART#	MATERIAL	COLOR
\$516.20	UBC110BL	Cloth	Blue
\$516.20	UBC110BK	Cloth	Black
\$516.20	UBC110R	Cloth	Red
\$516.20	UBC110G	Cloth	Green
\$718.58	UBF110BL	Foam	Blue
\$718.58	UBF110BK	Foam	Black
\$718.58	UBF110R	Foam	Red
\$718.58	UBF110G	Foam	Green

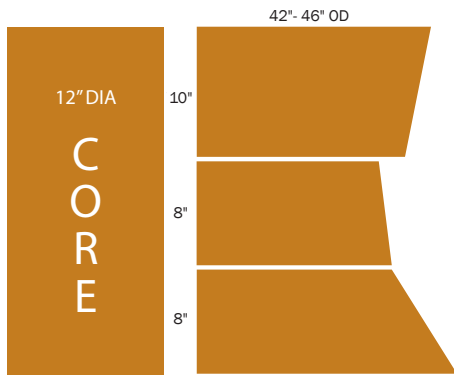

MODEL 2X2
DRIVER PASSENGER
26" HIGH CORE
FIVE STAR CAR WASH FOR BELANGER

- 12" Diameter core
- 44 Channels x 28" high
- **CLOTH REPLACEMENT**
- 44 pcs: 10" x 18"/14"
- 44 pcs: 8" x 14"/15"
- 44 pcs: 8" x 15"/20"

PRICE	PART#	MATERIAL	COLOR
\$827.74	UBC115BL	Cloth	Blue
\$827.74	UBC115BK	Cloth	Black
\$827.74	UBC115R	Cloth	Red
\$827.74	UBC115G	Cloth	Green
\$1,114.26	UBF115BL	Foam	Blue
\$1,114.26	UBF115BK	Foam	Black
\$1,114.26	UBF115R	Foam	Red
\$1,114.26	UBF115G	Foam	Green

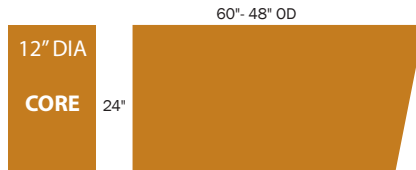

24" HIGH HITCH-HIKER
FIVE STAR CAR WASH FOR BELANGER

- 12" Diameter core
- 12 Channels x 24" high
- **CLOTH REPLACEMENT**
- 12 pcs: 24" x 24"/18"

PRICE	PART#	MATERIAL	COLOR
\$186.47	UBC120BL	Cloth	Blue
\$186.47	UBC120BK	Cloth	Black
\$186.47	UBC120R	Cloth	Red
\$186.47	UBC120G	Cloth	Green
\$295.62	UBF120BL	Foam	Blue
\$295.62	UBF120BK	Foam	Black
\$295.62	UBF120R	Foam	Red
\$295.62	UBF120G	Foam	Green

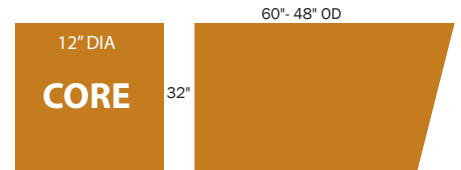

32" HIGH HITCH-HIKER
FIVE STAR CAR WASH FOR BELANGER

- 12" Diameter core
- 12 Channels x 32" high
- **CLOTH REPLACEMENT**
- 12 pcs: 32" x 24"/18"

PRICE	PART#	MATERIAL	COLOR
\$238.77	UBC125BL	Cloth	Blue
\$238.77	UBC125BK	Cloth	Black
\$238.77	UBC125R	Cloth	Red
\$238.77	UBC125G	Cloth	Green
\$379.75	UBF125BL	Foam	Blue
\$379.75	UBF125BK	Foam	Black
\$379.75	UBF125R	Foam	Red
\$379.75	UBF125G	Foam	Green

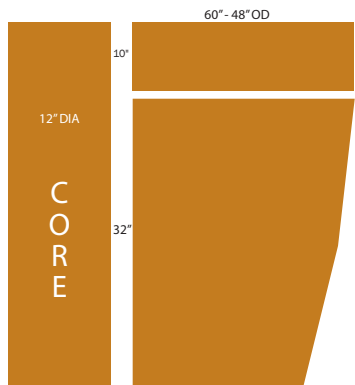

42" COMBO WASH™
MODULE WRAP TOP
FIVE STAR CAR WASH FOR BELANGER

- 12" Diameter core
- 12 Channels x 42" high
- **CLOTH REPLACEMENT**
- 12 pcs: 10" x 24"
- 12 pcs: 32" x 24"/18"

PRICE	PART#	MATERIAL	COLOR
\$334.27	UBC160BL	Cloth	Blue
\$334.27	UBC160BK	Cloth	Black
\$334.27	UBC160R	Cloth	Red
\$334.27	UBC160G	Cloth	Green
\$511.65	UBF160BL	Foam	Blue
\$511.65	UBF160BK	Foam	Black
\$511.65	UBF160R	Foam	Red
\$511.65	UBF160G	Foam	Green



REPLACEMENT CLOTH & FOAM- BELANGER® MODELS

FOAM AND CLOTH AVAILABLE IN THE FOLLOWING COLORS: ● ● ● ●

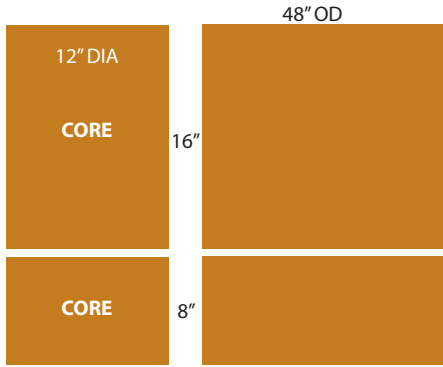

**24" COMBO WASH™
MODULE WRAP BOTTOM**

FIVE STAR CAR WASH FOR BELANGER

- 12" Diameter core
- 44 Channels x 24" high
- **CLOTH REPLACEMENT**
- 44 pcs: 16" x 18"
- 44 pcs: 8" x 18"

PRICE	PART#	MATERIAL	COLOR
\$684.47	UBC155BL	Cloth	Blue
\$684.47	UBC155BK	Cloth	Black
\$684.47	UBC155R	Cloth	Red
\$684.47	UBC155G	Cloth	Green
\$920.97	UBF155BL	Foam	Blue
\$920.97	UBF155BK	Foam	Black
\$920.97	UBF155R	Foam	Red
\$920.97	UBF155G	Foam	Green

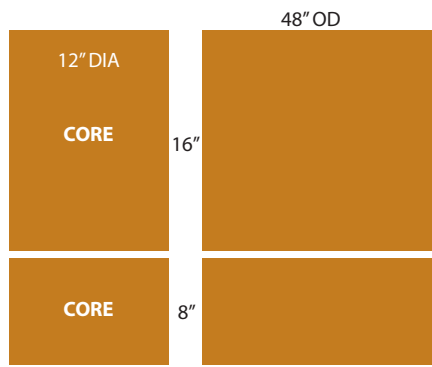

**24" WRAP AROUND
WITH CLUTCH**

FIVE STAR CAR WASH F BELANGER

- 12" Diameter core
- 44 Channels x 24" high
- **CLOTH REPLACEMENT**
- 44 pcs: 16" x 18"
- 44 pcs: 8" x 18"

PRICE	PART#	MATERIAL	COLOR
\$684.47	UBC130BL	Cloth	Blue
\$684.47	UBC130BK	Cloth	Black
\$684.47	UBC130R	Cloth	Red
\$684.47	UBC130G	Cloth	Green
\$920.98	UBF130BL	Foam	Blue
\$920.98	UBF130BK	Foam	Black
\$920.98	UBF130R	Foam	Red
\$920.98	UBF130G	Foam	Green

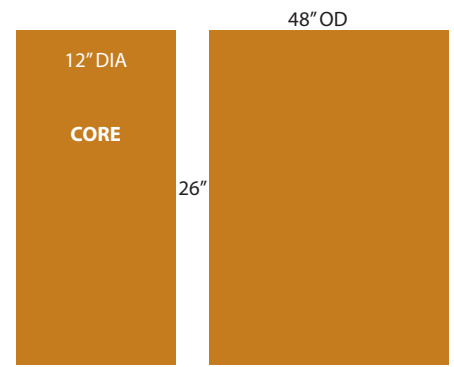

**26" WRAP AROUND WHEEL
WITH CLUTCH**

FIVE STAR CAR WASH FOR BELANGER

- 12" Diameter core
- 44 Channels x 26" high
- **CLOTH REPLACEMENT**
- 44 pcs: 26" x 18"

PRICE	PART#	MATERIAL	COLOR
\$575.33	UBC135BL	Cloth	Blue
\$575.33	UBC135BK	Cloth	Black
\$575.33	UBC135R	Cloth	Red
\$575.33	UBC135G	Cloth	Green
\$907.33	UBF135BL	Foam	Blue
\$907.33	UBF135BK	Foam	Black
\$907.33	UBF135R	Foam	Red
\$907.33	UBF135G	Foam	Green

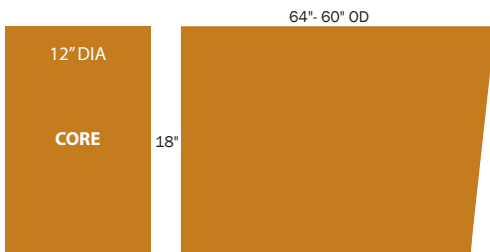

**18" PROGRAMMABLE SIDE WASHER
TOP SECTION**

FIVE STAR CAR WASH FOR BELANGER

- 12" Diameter core
- 12 Channels x 18" high
- **CLOTH REPLACEMENT**
- 12 pcs: 18" x 26"/24"

PRICE	PART#	MATERIAL	COLOR
\$166.01	UBC140BL	Cloth	Blue
\$166.01	UBC140BK	Cloth	Black
\$166.01	UBC140R	Cloth	Red
\$166.01	UBC140G	Cloth	Green
\$268.34	UBF140BL	Foam	Blue
\$268.34	UBF140BK	Foam	Black
\$268.34	UBF140R	Foam	Red
\$268.34	UBF140G	Foam	Green

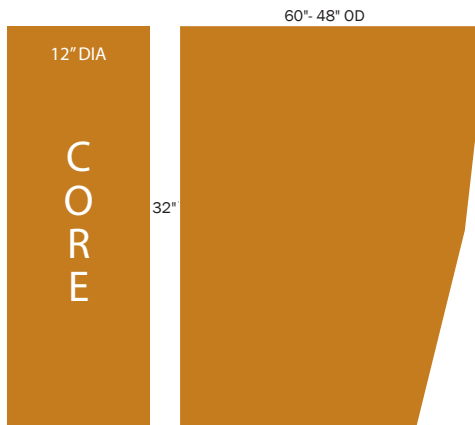

**32" PROGRAMMABLE SIDE WASHER
CENTER SECTION**

FIVE STAR CAR WASH FOR BELANGER

- 12" Diameter core
- 12 Channels x 32" high
- **CLOTH REPLACEMENT**
- 12 pcs: 32" x 24"/18"

PRICE	PART#	MATERIAL	COLOR
\$238.78	UBC145BL	Cloth	Blue
\$238.78	UBC145BK	Cloth	Black
\$238.78	UBC145R	Cloth	Red
\$238.78	UBC145G	Cloth	Green
\$379.75	UBF145BL	Foam	Blue
\$379.75	UBF145BK	Foam	Black
\$379.75	UBF145R	Foam	Red
\$379.75	UBF145G	Foam	Green

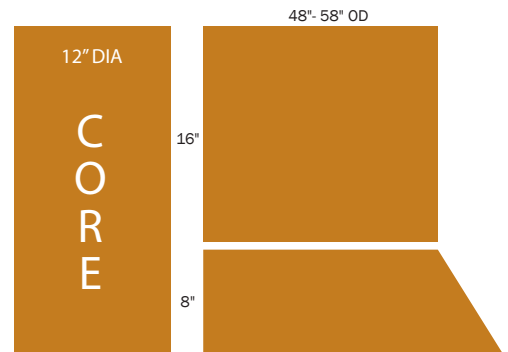

**24" PROGRAMMABLE SIDE WASHER
BOTTOM SECTION**

FIVE STAR CAR WASH FOR BELANGER

- 12" Diameter core
- 44 Channels x 24" high
- **CLOTH REPLACEMENT**
- 44 pcs: 16" x 18"
- 44 pcs: 8" x 18"/23"

PRICE	PART#	MATERIAL	COLOR
\$700.39	UBC150BL	Cloth	Blue
\$700.39	UBC150BK	Cloth	Black
\$700.39	UBC150R	Cloth	Red
\$700.39	UBC150G	Cloth	Green
\$955.08	UBF150BL	Foam	Blue
\$955.08	UBF150BK	Foam	Black
\$955.08	UBF150R	Foam	Red
\$955.08	UBF150G	Foam	Green



REPLACEMENT CLOTH & FOAM- ECONOCRAFT® MODELS

FOAM AND CLOTH AVAILABLE IN THE FOLLOWING COLORS:



35" VAN HIGH BRUSH TOP SECTION

FIVE STAR CAR WASH FOR ECONOCRAFT

- 6" Diameter core
- 16 Channels x 35" high
- **CLOTH REPLACEMENT**
- 16 pcs: 35" x 31"/27"

PRICE	PART#	MATERIAL	COLOR
\$418.42	UBC200BL	Cloth	Blue
\$418.42	UBC200BK	Cloth	Black
\$418.42	UBC200R	Cloth	Red
\$418.42	UBC200G	Cloth	Green
\$611.70	UBF200BL	Foam	Blue
\$611.70	UBF200BK	Foam	Black
\$611.70	UBF200R	Foam	Red
\$611.70	UBF200G	Foam	Green

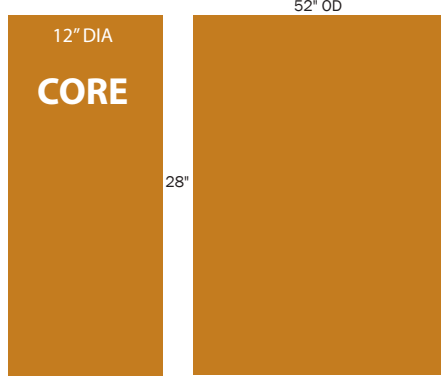

28" VAN HIGH BRUSH BOTTOM SECTION

FIVE STAR CAR WASH FOR ECONOCRAFT

- 12" Diameter core
- 48 Channels x 28" high
- **CLOTH REPLACEMENT**
- 48 pcs: 28" x 20"

PRICE	PART#	MATERIAL	COLOR
\$750.42	UBC205BL	Cloth	Blue
\$750.42	UBC205BK	Cloth	Black
\$750.42	UBC205R	Cloth	Red
\$750.42	UBC205G	Cloth	Green
\$1,057.41	UBF205BL	Foam	Blue
\$1,057.41	UBF205BK	Foam	Black
\$1,057.41	UBF205R	Foam	Red
\$1,057.41	UBF205G	Foam	Green

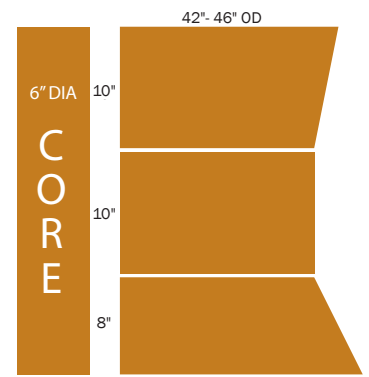

28" HIGH DRIVER SIDE BRUSH

FIVE STAR CAR WASH FOR ECONOCRAFT

- 6" Diameter core
- 32 Channels x 28" high
- **CLOTH REPLACEMENT**
- 32 pcs: 10" x 18"/16"
- 32 pcs: 10" x 16"
- 32 pcs: 8" x 16"/20"

PRICE	PART#	MATERIAL	COLOR
\$620.80	UBC210BL	Cloth	Blue
\$620.80	UBC210BK	Cloth	Black
\$620.80	UBC210R	Cloth	Red
\$620.80	UBC210G	Cloth	Green
\$852.75	UBF210BL	Foam	Blue
\$852.75	UBF210BK	Foam	Black
\$852.75	UBF210R	Foam	Red
\$852.75	UBF210G	Foam	Green

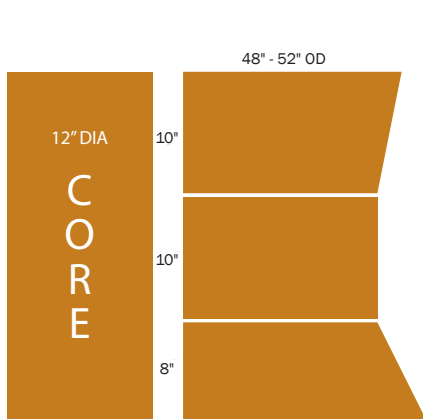

28" HIGH PASSENGER SIDE BRUSH

FIVE STAR CAR WASH FOR ECONOCRAFT

- 12" Diameter core
- 48 Channels x 28" high
- **CLOTH REPLACEMENT**
- 48 pcs: 10" x 18"/16"
- 48 pcs: 10" x 16"
- 48 pcs: 8" x 16"/20"

PRICE	PART#	MATERIAL	COLOR
\$916.42	UBC215BL	Cloth	Blue
\$916.42	UBC215BK	Cloth	Black
\$916.42	UBC215R	Cloth	Red
\$916.42	UBC215G	Cloth	Green
\$1,280.26	UBF215BL	Foam	Blue
\$1,280.26	UBF215BK	Foam	Black
\$1,280.26	UBF215R	Foam	Red
\$1,280.26	UBF215G	Foam	Green

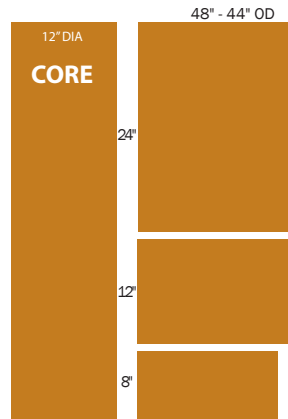

44" WRAP AROUND TOP SECTION

FIVE STAR CAR WASH FOR ECONOCRAFT

- 12" Diameter core
- 16 Channels x 44" high
- **CLOTH REPLACEMENT**
- 16 pcs: 24" x 18" W/ 2" Slit
- 16 pcs: 12" x 18" W/ 1" Slit
- 16 pcs: 8" x 16" W/ 1" Slit

PRICE	PART#	MATERIAL	COLOR
\$402.49	UBC220BL	Cloth	Blue
\$402.49	UBC220BK	Cloth	Black
\$402.49	UBC220R	Cloth	Red
\$402.49	UBC220G	Cloth	Green
\$668.56	UBF220BL	Foam	Blue
\$668.56	UBF220BK	Foam	Black
\$543.49	UBF220R	Foam	Red
\$668.56	UBF220G	Foam	Green

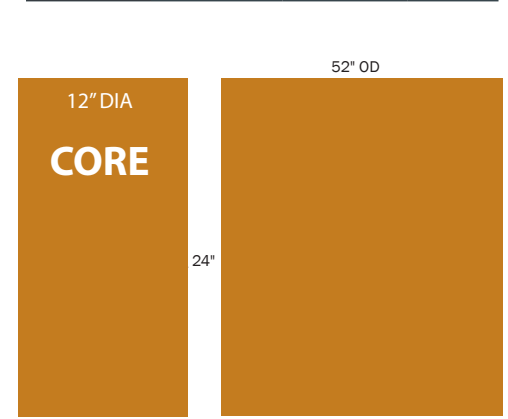

24" WRAP AROUND BOTTOM SECTION

FIVE STAR CAR WASH FOR ECONOCRAFT

- 12" Diameter core
- 48 Channels x 24" high
- **CLOTH REPLACEMENT**
- 48 pcs: 24" x 18"

PRICE	PART#	MATERIAL	COLOR
\$600.33	UBC225BL	Cloth	Blue
\$600.33	UBC225BK	Cloth	Black
\$600.33	UBC225R	Cloth	Red
\$600.33	UBC225G	Cloth	Green
\$914.15	UBF225BL	Foam	Blue
\$914.15	UBF225BK	Foam	Black
\$914.15	UBF225R	Foam	Red
\$914.15	UBF225G	Foam	Green



REPLACEMENT CLOTH & FOAM- HANNA™ MODELS

FOAM AND CLOTH AVAILABLE IN THE FOLLOWING COLORS: ● ● ● ●

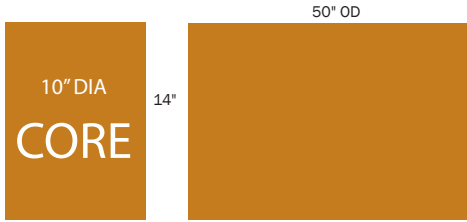

**HUBCAP ROCKER PANEL
10 x 14 x 50 STRAIGHT CUT**
FIVE STAR CAR WASH FOR HANNA

- 10" Diameter core
- 30 Channels x 14" high
- **CLOTH REPLACEMENT**
- 30 pcs: 14" x 20"

PRICE	PART#	MATERIAL	COLOR
\$277.43	UBC400BL	Cloth	Blue
\$277.43	UBC400BK	Cloth	Black
\$277.43	UBC400R	Cloth	Red
\$277.43	UBC400G	Cloth	Green
\$400.22	UBF400BL	Foam	Blue
\$400.22	UBF400BK	Foam	Black
\$400.22	UBF400R	Foam	Red
\$400.22	UBF400G	Foam	Green

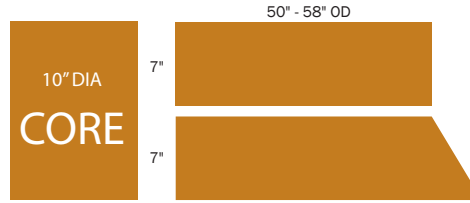

**HUBCAP ROCKER PANEL
10 x 14 x 50/58 ANGLE CUT**
FIVE STAR CAR WASH FOR HANNA

- 10" Diameter core
- 30 Channels x 14" high
- **CLOTH REPLACEMENT**
- 30 pcs: 7" x 20"
- 30 pcs: 7" x 20/24"

PRICE	PART#	MATERIAL	COLOR
\$352.46	UBC405BL	Cloth	Blue
\$352.46	UBC405BK	Cloth	Black
\$352.46	UBC405R	Cloth	Red
\$352.46	UBC405G	Cloth	Green
\$541.21	UBF405BL	Foam	Blue
\$541.21	UBF405BK	Foam	Black
\$541.21	UBF405R	Foam	Red
\$541.21	UBF405G	Foam	Green

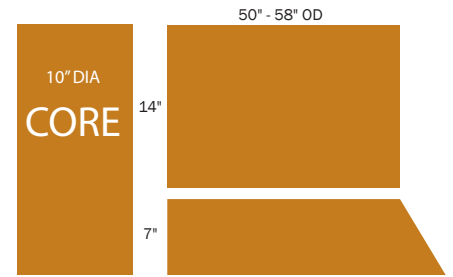

**HUBCAP ROCKER PANEL
10 x 21 x 50/58 ANGLE CUT**
FIVE STAR CAR WASH FOR HANNA

- 10" Diameter core
- 30 Channels x 14" high
- **CLOTH REPLACEMENT**
- 30 pcs: 14" x 20"
- 30 pcs: 7" x 20/24"

PRICE	PART#	MATERIAL	COLOR
\$452.53	UBC415BL	Cloth	Blue
\$452.53	UBC415BK	Cloth	Black
\$452.53	UBC415R	Cloth	Red
\$452.53	UBC415G	Cloth	Green
\$661.73	UBF415BL	Foam	Blue
\$661.73	UBF415BK	Foam	Black
\$661.73	UBF415R	Foam	Red
\$661.73	UBF415G	Foam	Green

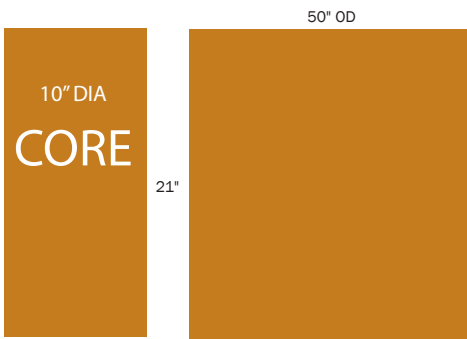

**HUBCAP ROCKER PANEL
10 x 21 x 50 STRAIGHT CUT**
FIVE STAR CAR WASH FOR HANNA

- 10" Diameter core
- 30 Channels x 21" high
- **CLOTH REPLACEMENT**
- 30 pcs: 21" x 20"

PRICE	PART#	MATERIAL	COLOR
\$361.56	UBC410BL	Cloth	Blue
\$361.56	UBC410BK	Cloth	Black
\$361.56	UBC410R	Cloth	Red
\$361.56	UBC410G	Cloth	Green
\$557.14	UBF410BL	Foam	Blue
\$557.14	UBF410BK	Foam	Black
\$557.14	UBF410R	Foam	Red
\$557.14	UBF410G	Foam	Green

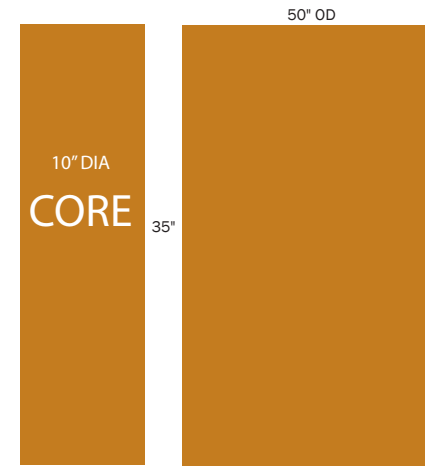

**HUBCAP ROCKER PANEL
10 x 35 x 50 STRAIGHT CUT**
FIVE STAR CAR WASH FOR HANNA

- 10" Diameter core
- 30 Channels x 35" high
- **CLOTH REPLACEMENT**
- 30 pcs: 35" x 20"

PRICE	PART#	MATERIAL	COLOR
\$573.05	UBC420BL	Cloth	Blue
\$573.05	UBC420BK	Cloth	Black
\$573.05	UBC420R	Cloth	Red
\$573.05	UBC420G	Cloth	Green
\$886.85	UBF420BL	Foam	Blue
\$886.85	UBF420BK	Foam	Black
\$886.85	UBF420R	Foam	Red
\$886.85	UBF420G	Foam	Green

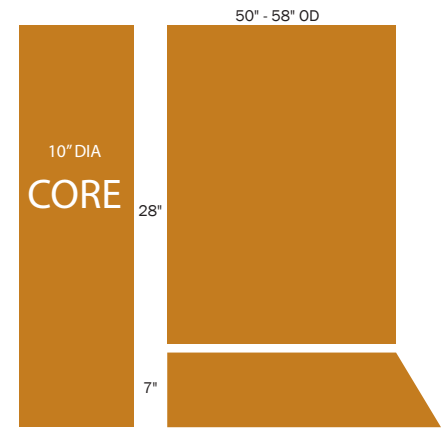

**HUBCAP ROCKER PANEL
10 x 35 x 50/58 ANGLE CUT**
FIVE STAR CAR WASH FOR HANNA

- 10" Diameter core
- 30 Channels x 35" high
- **CLOTH REPLACEMENT**
- 30 pcs: 28" x 20"
- 30 pcs: 7" x 20/24"

PRICE	PART#	MATERIAL	COLOR
\$625.34	UBC425BL	Cloth	Blue
\$625.34	UBC425BK	Cloth	Black
\$625.34	UBC425R	Cloth	Red
\$625.34	UBC425G	Cloth	Green
\$977.83	UBF425BL	Foam	Blue
\$977.83	UBF425BK	Foam	Black
\$977.83	UBF425R	Foam	Red
\$977.83	UBF425G	Foam	Green



REPLACEMENT CLOTH & FOAM- HANNA™ MODELS

FOAM AND CLOTH AVAILABLE IN THE FOLLOWING COLORS: ● ● ● ●

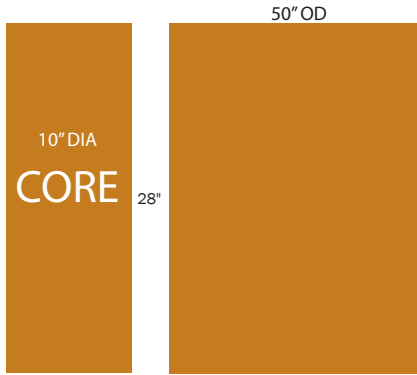

ROCKER PANEL SIDE WASHER
10 x 28 x 50 STRAIGHT CUT
 FIVE STAR CAR WASH FOR HANNA

- 10" Diameter core
- 30 Channels x 28" high
- **CLOTH REPLACEMENT**
- 30 pcs: 28" x 20"

PRICE	PART#	MATERIAL	COLOR
\$452.53	UBC430BL	Cloth	Blue
\$452.53	UBC430BK	Cloth	Black
\$452.53	UBC430R	Cloth	Red
\$452.53	UBC430G	Cloth	Green
\$670.83	UBF430BL	Foam	Blue
\$670.83	UBF430BK	Foam	Black
\$670.83	UBF430R	Foam	Red
\$670.83	UBF430G	Foam	Green

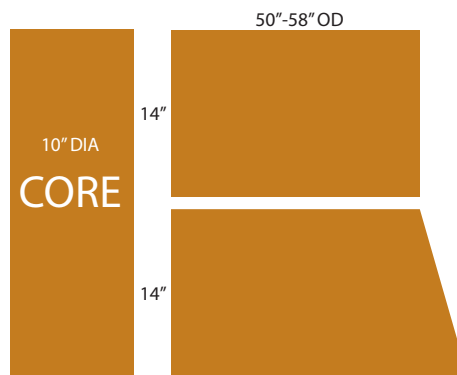

ROCKER PANEL SIDE WASHER
10 x 28 x 50/58 ANGLE CUT
 FIVE STAR CAR WASH FOR HANNA

- 10" Diameter core
- 30 Channels x 28" high
- **CLOTH REPLACEMENT**
- 30 pcs: 14" x 20"

PRICE	PART#	MATERIAL	COLOR
\$670.83	UBC435BL	Cloth	Blue
\$573.05	UBC435BK	Cloth	Black
\$573.05	UBC435R	Cloth	Red
\$573.05	UBC435G	Cloth	Green
\$834.56	UBF435BL	Foam	Blue
\$834.56	UBF435BK	Foam	Black
\$834.56	UBF435R	Foam	Red
\$834.56	UBF435G	Foam	Green

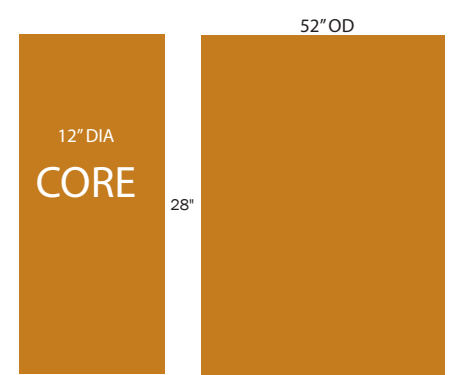

ROCKER PANEL SIDE WASHER
12 x 28 x 52 STRAIGHT CUT
 FIVE STAR CAR WASH FOR HANNA

- 12" Diameter core
- 36 Channels x 28" high
- **CLOTH REPLACEMENT**
- 36 pcs: 28" x 20"

PRICE	PART#	MATERIAL	COLOR
\$543.49	UBC440BL	Cloth	Blue
\$543.49	UBC440BK	Cloth	Black
\$543.49	UBC440R	Cloth	Red
\$543.49	UBC440G	Cloth	Green
\$814.09	UBF440BL	Foam	Blue
\$814.09	UBF440BK	Foam	Black
\$814.09	UBF440R	Foam	Red
\$814.09	UBF440G	Foam	Green

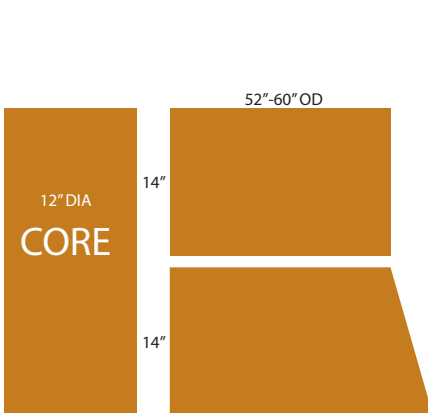

ROCKER PANEL SIDE WASHER
12 x 28 x 52/60 ANGLE CUT
 FIVE STAR CAR WASH FOR HANNA

- 12" Diameter core
- 36 Channels x 28" high
- **CLOTH REPLACEMENT**
- 36 pcs: 14" x 20"

PRICE	PART#	MATERIAL	COLOR
\$684.47	UBC445BL	Cloth	Blue
\$684.47	UBC445BK	Cloth	Black
\$684.47	UBC445R	Cloth	Red
\$684.47	UBC445G	Cloth	Green
\$1,002.83	UBF445BL	Foam	Blue
\$1,002.83	UBF445BK	Foam	Black
\$1,002.83	UBF445R	Foam	Red
\$1,002.83	UBF445G	Foam	Green

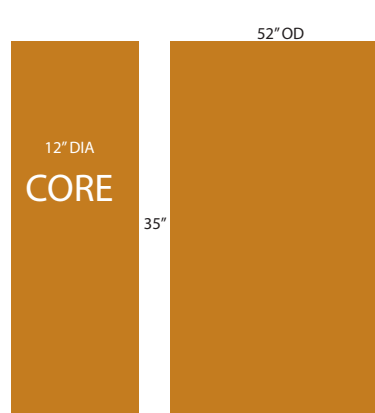

SIDE WASHER BRUSH
12 x 35 x 52 STRAIGHT CUT
 FIVE STAR CAR WASH FOR HANNA

- 12" Diameter core
- 36 Channels x 25" high
- **CLOTH REPLACEMENT**
- 36 pcs: 35" x 20"

PRICE	PART#	MATERIAL	COLOR
\$689.02	UBC450BL	Cloth	Blue
\$689.02	UBC450BK	Cloth	Black
\$689.02	UBC450R	Cloth	Red
\$689.02	UBC450G	Cloth	Green
\$1,064.24	UBF450BL	Foam	Blue
\$1,064.24	UBF450BK	Foam	Black
\$1,064.24	UBF450R	Foam	Red
\$1,064.24	UBF450G	Foam	Green

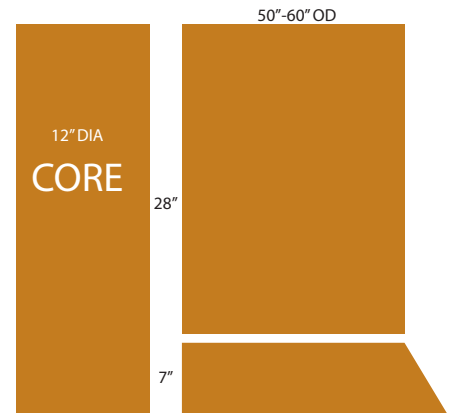

SIDE WASHER BRUSH
12 x 35 x 60 ANGLE CUT
 FIVE STAR CAR WASH FOR HANNA

- 12" Diameter core
- 36 Channels x 35" high
- **CLOTH REPLACEMENT**
- 36 pcs: 28" x 20"

PRICE	PART#	MATERIAL	COLOR
\$750.42	UBC455BL	Cloth	Blue
\$750.42	UBC455BK	Cloth	Black
\$750.42	UBC455R	Cloth	Red
\$750.42	UBC455G	Cloth	Green
\$1,173.38	UBF455BL	Foam	Blue
\$1,173.38	UBF455BK	Foam	Black
\$1,173.38	UBF455R	Foam	Red
\$1,173.38	UBF455G	Foam	Green



REPLACEMENT CLOTH & FOAM- HANNA™ MODELS

FOAM AND CLOTH AVAILABLE IN THE FOLLOWING COLORS: ● ● ● ●

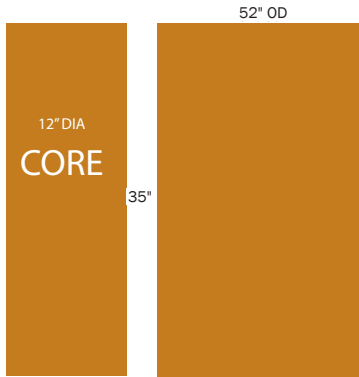

**SIDE WASHER AROUND BRUSH
12 X 35 X 52 STRAIGHT CUT**
FIVE STAR CAR WASH FOR HANNA

- 12" Diameter core
- 18 Channels x 35" high
- **CLOTH REPLACEMENT**
- 18 pcs: 35" x 20"

PRICE	PART#	MATERIAL	COLOR
\$345.65	UBC460BL	Cloth	Blue
\$345.65	UBC460BK	Cloth	Black
\$345.65	UBC460R	Cloth	Red
\$345.65	UBC460G	Cloth	Green
\$534.39	UBF460BL	Foam	Blue
\$534.39	UBF460BK	Foam	Black
\$534.39	UBF460R	Foam	Red
\$534.39	UBF460G	Foam	Green

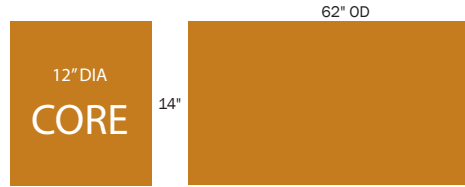

**HORIZONTAL WINDOW WASHER
12 X 14 X 62 STRAIGHT CUT**
FIVE STAR CAR WASH FOR HANNA

- 12" Diameter core
- 9 Channels x 14" high
- **CLOTH REPLACEMENT**
- 9 pcs: 14" x 25"

PRICE	PART#	MATERIAL	COLOR
\$103.53	UBC465BL	Cloth	Blue
\$103.53	UBC465BK	Cloth	Black
\$103.53	UBC465R	Cloth	Red
\$103.53	UBC465G	Cloth	Green
\$172.83	UBF465BL	Foam	Blue
\$172.83	UBF465BK	Foam	Black
\$172.83	UBF465R	Foam	Red
\$172.83	UBF465G	Foam	Green



**HORIZONTAL WINDOW WASHER
12 X 21 X 62 STRAIGHT CUT**
FIVE STAR CAR WASH FOR HANNA

- 12" Diameter core
- 9 Channels x 21" high
- **CLOTH REPLACEMENT**
- 9 pcs: 21" x 25"

PRICE	PART#	MATERIAL	COLOR
\$134.16	UBC470BL	Cloth	Blue
\$134.16	UBC470BK	Cloth	Black
\$134.16	UBC470R	Cloth	Red
\$134.16	UBC470G	Cloth	Green
\$250.15	UBF470BL	Foam	Blue
\$250.15	UBF470BK	Foam	Black
\$250.15	UBF470R	Foam	Red
\$250.15	UBF470G	Foam	Green

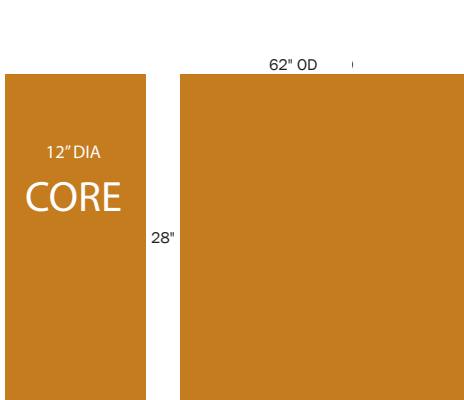

**HORIZONTAL WINDOW WASHER
12 X 28 X 62 STRAIGHT CUT**
FIVE STAR CAR WASH FOR HANNA

- 12" Diameter core
- 9 Channels x 28" high
- **CLOTH REPLACEMENT**
- 9 pcs: 28" x 25"

PRICE	PART#	MATERIAL	COLOR
\$168.28	UBC475BL	Cloth	Blue
\$168.28	UBC475BK	Cloth	Black
\$168.28	UBC475R	Cloth	Red
\$168.28	UBC475G	Cloth	Green
\$334.27	UBF475BL	Foam	Blue
\$334.27	UBF475BK	Foam	Black
\$334.27	UBF475R	Foam	Red
\$334.27	UBF475G	Foam	Green

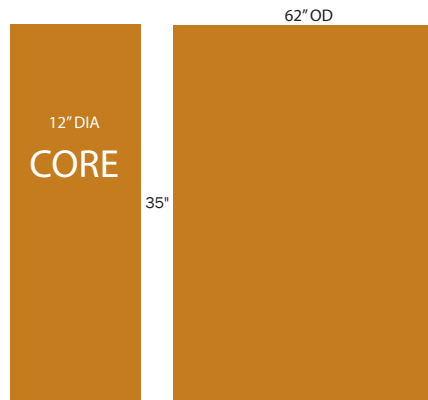

**HORIZONTAL WINDOW WASHER
12 X 35 X 62 STRAIGHT CUT**
FIVE STAR CAR WASH FOR HANNA

- 12" Diameter core
- 9 Channels x 35" high
- **CLOTH REPLACEMENT**
- 9 pcs: 35" x 25"

PRICE	PART#	MATERIAL	COLOR
\$236.49	UBC480BL	Cloth	Blue
\$236.49	UBC480BK	Cloth	Black
\$236.49	UBC480R	Cloth	Red
\$236.49	UBC480G	Cloth	Green
\$418.43	UBF480BL	Foam	Blue
\$418.43	UBF480BK	Foam	Black
\$418.43	UBF480R	Foam	Red
\$418.43	UBF480G	Foam	Green

KNOW WHEN TO REPLACE YOUR CLOTHS

Even the most experienced and conscientious operators eventually have to replace their cloth. Don't wait until the last minute to replace your cloth (when you have a series of damage claims or you start to lose customers because you are not doing a good enough job of cleaning their cars).

Excessive amounts of fraying and tearing at the tips of the cloth is a good indication it needs to be replaced.



REPLACEMENT CLOTH & FOAM- SONNY'S® MODELS

FOAM AND CLOTH AVAILABLE IN THE FOLLOWING COLORS: ● ● ● ●

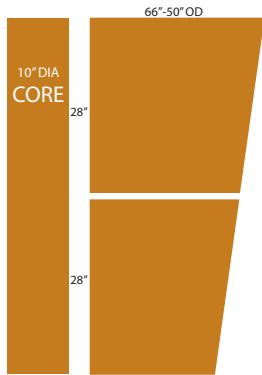

SF77 WRAP AROUND TOP SECTION
FIVE STAR CAR WASH FOR SONNY'S

- 10" Diameter core
- 10 Channels x 48" high
- **CLOTH REPLACEMENT**
- 10 pcs: 28" x 28"/24"
- 10 pcs: 4" x 20" x 24"/20"

PRICE	PART#	MATERIAL	COLOR
\$357.01	UBC500BL	Cloth	Blue
\$357.01	UBC500BK	Cloth	Black
\$357.01	UBC500R	Cloth	Red
\$357.01	UBC500G	Cloth	Green
\$595.79	UBF500BL	Foam	Blue
\$595.79	UBF500BK	Foam	Black
\$595.79	UBF500R	Foam	Red
\$595.79	UBF500G	Foam	Green



SF77 WRAP AROUND BOTTOM SECTION
FIVE STAR CAR WASH FOR SONNY'S

- 12" Diameter core
- 44 Channels x 24" high
- **CLOTH REPLACEMENT**
- 22 pcs: 24" x 18" 1-ply
- 22 pcs: 24" x 18" 2-ply

*** ALTERNATE 1-PLY/2-PLY EVERY OTHER CHANNEL**

PRICE	PART#	MATERIAL	COLOR
\$775.43	UBC505BL	Cloth	Blue
\$775.43	UBC505BK	Cloth	Black
\$775.43	UBC505R	Cloth	Red
\$775.43	UBC505G	Cloth	Green
\$1,173.39	UBF505BL	Foam	Blue
\$1,173.39	UBF505BK	Foam	Black
\$1,173.39	UBF505R	Foam	Red
\$1,173.39	UBF505G	Foam	Green

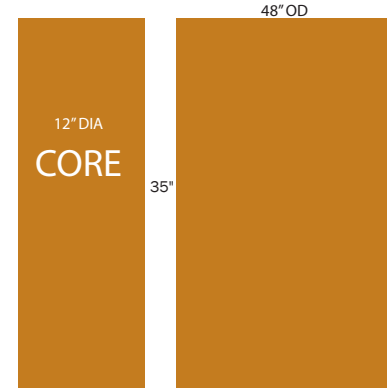

SFB35 WHEEL
FIVE STAR CAR WASH FOR SONNY'S

- 12" Diameter core
- 44 Channels x 35" high
- **CLOTH REPLACEMENT**
- 44 pcs: 35" x 18"

PRICE	PART#	MATERIAL	COLOR
\$714.04	UBC510BL	Cloth	Blue
\$714.04	UBC510BK	Cloth	Black
\$714.04	UBC510R	Cloth	Red
\$714.04	UBC510G	Cloth	Green
\$1,177.93	UBF510BL	Foam	Blue
\$1,177.93	UBF510BK	Foam	Black
\$1,177.93	UBF510R	Foam	Red
\$1,177.93	UBF510G	Foam	Green

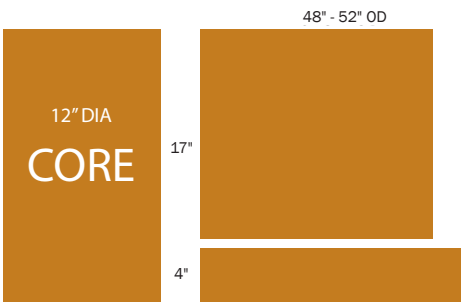

SFB21 WHEEL
FIVE STAR CAR WASH FOR SONNY'S

- 12" Diameter core
- 44 Channels x 21" high
- **CLOTH REPLACEMENT**
- 22 pcs: 17" x 18"
- 44 pcs: 4" x 20"

PRICE	PART#	MATERIAL	COLOR
\$413.87	UBC515BL	Cloth	Blue
\$413.87	UBC515BK	Cloth	Black
\$413.87	UBC515R	Cloth	Red
\$413.87	UBC515G	Cloth	Green
\$591.24	UBF515BL	Foam	Blue
\$591.24	UBF515BK	Foam	Black
\$591.24	UBF515R	Foam	Red
\$591.24	UBF515G	Foam	Green

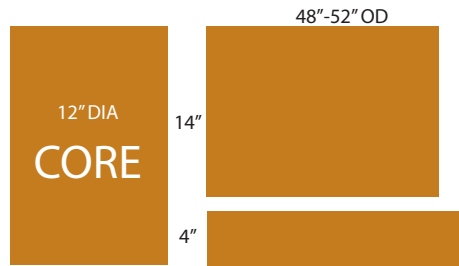

SFB18 WHEEL
FIVE STAR CAR WASH FOR SONNY'S

- 12" Diameter core
- 44 Channels x 18" high
- **CLOTH REPLACEMENT**
- 22 pcs: 14" x 18"
- 44 pcs: 4" x 20"

PRICE	PART#	MATERIAL	COLOR
\$388.85	UBC520BL	Cloth	Blue
\$388.85	UBC520BK	Cloth	Black
\$388.85	UBC520R	Cloth	Red
\$388.85	UBC520G	Cloth	Green
\$586.69	UBF520BL	Foam	Blue
\$586.69	UBF520BK	Foam	Black
\$586.69	UBF520R	Foam	Red
\$586.69	UBF520G	Foam	Green

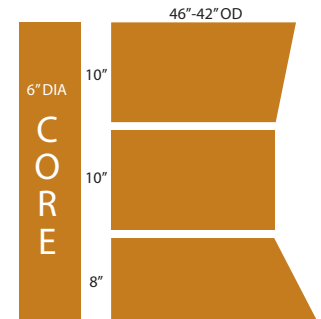

SF1 • SF2 • SF3 DRIVE SIDE WHEEL
FIVE STAR CAR WASH FOR SONNY'S

- 6" Diameter core
- 28 Channels x 28" high
- **CLOTH REPLACEMENT**
- 28 pcs: 10" x 18"/16"
- 28 pcs: 10" x 16"
- 28 pcs: 8" x 16"/20"

PRICE	PART#	MATERIAL	COLOR
\$545.76	UBC525BL	Cloth	Blue
\$545.76	UBC525BK	Cloth	Black
\$545.76	UBC525R	Cloth	Red
\$545.76	UBC525G	Cloth	Green
\$745.87	UBF525BL	Foam	Blue
\$745.87	UBF525BK	Foam	Black
\$745.87	UBF525R	Foam	Red
\$745.87	UBF525G	Foam	Green



REPLACEMENT CLOTH & FOAM- SONNY'S® MODELS

FOAM AND CLOTH AVAILABLE IN THE FOLLOWING COLORS: ● ● ● ●

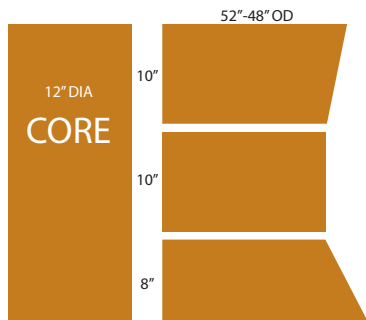

SF1 • SF2 • SF3 PASSENGER SIDE WHEEL/SFB28 WHEEL

FIVE STAR CAR WASH FOR SONNY'S

- 12" Diameter core
- 44 Channels x 28" high
- **CLOTH REPLACEMENT**
- 44 pcs: 10" x 18"/16"
- 44 pcs: 10" x 16"
- 44 pcs: 8" x 16"/20"

PRICE	PART#	MATERIAL	COLOR
\$857.30	UBC530BL	Cloth	Blue
\$857.30	UBC530BK	Cloth	Black
\$857.30	UBC530R	Cloth	Red
\$857.30	UBC530G	Cloth	Green
\$1,173.38	UBF530BL	Foam	Blue
\$1,173.38	UBF530BK	Foam	Black
\$1,173.38	UBF530R	Foam	Red
\$1,173.38	UBF530G	Foam	Green

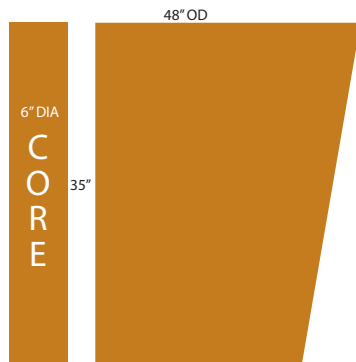

SF63 TOP SECTION

FIVE STAR CAR WASH FOR SONNY'S

- 6" Diameter core
- 12 Channels x 35" high
- **CLOTH REPLACEMENT**
- 12 pcs: 35" x 27"/21"

PRICE	PART#	MATERIAL	COLOR
\$286.53	UBC535BL	Cloth	Blue
\$286.53	UBC535BK	Cloth	Black
\$286.53	UBC535R	Cloth	Red
\$286.53	UBC535G	Cloth	Green
\$488.91	UBF535BL	Foam	Blue
\$488.91	UBF535BK	Foam	Black
\$488.91	UBF535R	Foam	Red
\$488.91	UBF535G	Foam	Green

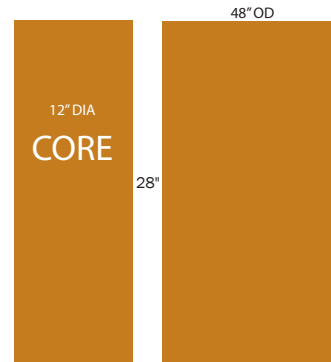

SF63 BOTTOM SECTION

FIVE STAR CAR WASH FOR SONNY'S

- 12" Diameter core
- 44 Channels x 28" high
- **CLOTH REPLACEMENT**
- 44 pcs: 28" x 18"

PRICE	PART#	MATERIAL	COLOR
\$625.35	UBC540BL	Cloth	Blue
\$625.35	UBC540BK	Cloth	Black
\$625.35	UBC540R	Cloth	Red
\$625.35	UBC540G	Cloth	Green
\$968.72	UBF540BL	Foam	Blue
\$968.72	UBF540BK	Foam	Black
\$968.72	UBF540R	Foam	Red
\$968.72	UBF540G	Foam	Green

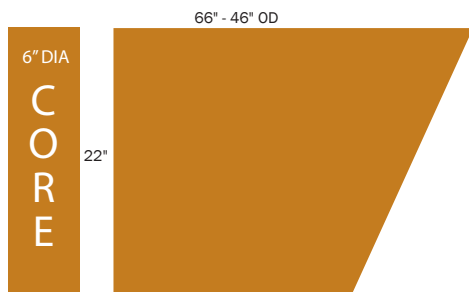

SF50 & SFB50 TOP SECTION

FIVE STAR CAR WASH FOR SONNY'S

- 6" Diameter core
- 8 Channels x 22" high
- **CLOTH REPLACEMENT**
- 8 pcs: 22" x 30"/20"

PRICE	PART#	MATERIAL	COLOR
\$142.12	UBC545BL	Cloth	Blue
\$142.12	UBC545BK	Cloth	Black
\$142.12	UBC545R	Cloth	Red
\$142.12	UBC545G	Cloth	Green
\$213.76	UBF545BL	Foam	Blue
\$213.76	UBF545BK	Foam	Black
\$213.76	UBF545R	Foam	Red
\$213.76	UBF545G	Foam	Green

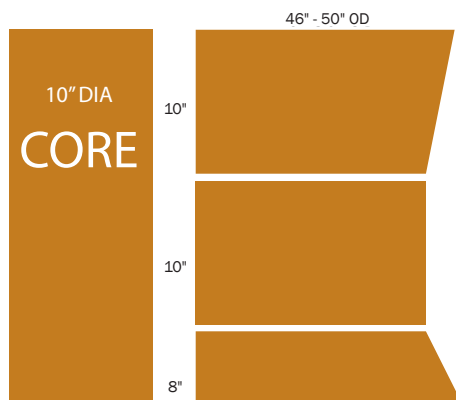

SF50 BOTTOM SECTION

FIVE STAR CAR WASH FOR SONNY'S

- 10" Diameter core
- 36 Channels x 28" high
- **CLOTH REPLACEMENT**
- 36 pcs: 10" x 18"/16"
- 36 pcs: 10" x 16"
- 36 pcs: 8" x 16"/20"

PRICE	PART#	MATERIAL	COLOR
\$700.38	UBC550BL	Cloth	Blue
\$700.38	UBC550BK	Cloth	Black
\$700.38	UBC550R	Cloth	Red
\$700.38	UBC550G	Cloth	Green
\$959.63	UBF550BL	Foam	Blue
\$959.63	UBF550BK	Foam	Black
\$959.63	UBF550R	Foam	Red
\$959.63	UBF550G	Foam	Green

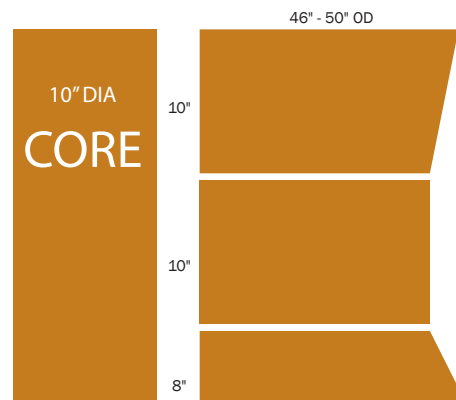

SFB50 BOTTOM SECTION

FIVE STAR CAR WASH FOR SONNY'S

- 10" Diameter core
- 26 Channels x 28" high
- **CLOTH REPLACEMENT**
- 44 pcs: 10" x 18"/16"
- 44 pcs: 10" x 16"
- 44 pcs: 8" x 16"/20"

PRICE	PART#	MATERIAL	COLOR
\$857.30	UBC552BL	Cloth	Blue
\$857.30	UBC552BK	Cloth	Black
\$857.30	UBC552R	Cloth	Red
\$857.30	UBC552G	Cloth	Green
\$1,173.38	UBF552BL	Foam	Blue
\$1,173.38	UBF552BK	Foam	Black
\$1,173.38	UBF552R	Foam	Red
\$1,173.38	UBF552G	Foam	Green

REPLACEMENT CLOTH & FOAM- SONNY'S® MODELS



FOAM AND CLOTH AVAILABLE IN THE FOLLOWING COLORS: ● ● ● ●

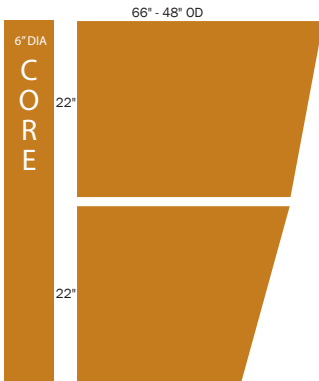

SF68 TOP SECTION FIVE STAR CAR WASH FOR SONNY'S

- 6" Diameter core
- 8 Channels x 44" high
- **CLOTH REPLACEMENT**
- 8 pcs: 22" x 30"/26"
- 8 pcs: 22" x 26"/21"

PRICE	PART#	MATERIAL	COLOR
\$286.53	UBC555BL	Cloth	Blue
\$286.53	UBC555BK	Cloth	Black
\$286.53	UBC555R	Cloth	Red
\$286.53	UBC555G	Cloth	Green
\$436.61	UBF555BL	Foam	Blue
\$436.61	UBF555BK	Foam	Black
\$436.61	UBF555R	Foam	Red
\$436.61	UBF555G	Foam	Green

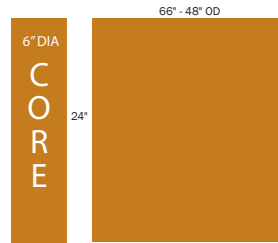

SF68 BOTTOM SECTION FIVE STAR CAR WASH FOR SONNY'S

- 6" Diameter core
- 28 Channels x 24" high
- **CLOTH REPLACEMENT**
- 28 pcs: 24" x 21" 2-ply

PRICE	PART#	MATERIAL	COLOR
\$691.28	UBC560BL	Cloth	Blue
\$691.28	UBC560BK	Cloth	Black
\$691.28	UBC560R	Cloth	Red
\$691.28	UBC560G	Cloth	Green
\$952.81	UBF560BL	Foam	Blue
\$952.81	UBF560BK	Foam	Black
\$952.81	UBF560R	Foam	Red
\$952.81	UBF560G	Foam	Green

REPLACEMENT CLOTH & FOAM- PECO® MODELS



FOAM AND CLOTH AVAILABLE IN THE FOLLOWING COLORS: ● ● ● ●

18" HUB CAP ROCKER WASHER PE118 FIVE STAR CAR WASH PECO

- 10" Diameter core
- 24 Channels x 18" high
- **CLOTH REPLACEMENT**
- 24 pcs: 13½" x 19"
- 24 pcs: 4" x 20"

PRICE	PART#	MATERIAL	COLOR
\$388.86	UBC300BL	Cloth	Blue
\$388.86	UBC300BK	Cloth	Black
\$388.86	UBC300R	Cloth	Red
\$388.86	UBC300G	Cloth	Green
\$557.13	UBF300BL	Foam	Blue
\$557.13	UBF300BK	Foam	Black
\$557.13	UBF300R	Foam	Red
\$557.13	UBF300G	Foam	Green

28" DETAIL SIDE WASHER PE128 FIVE STAR CAR WASH PECO

- 10" Diameter core
- 36 Channels x 28" high
- **CLOTH REPLACEMENT**
- 72 pcs: 13½" x 20"

PRICE	PART#	MATERIAL	COLOR
\$625.35	UBC315BL	Cloth	Blue
\$625.35	UBC315BK	Cloth	Black
\$625.35	UBC315R	Cloth	Red
\$625.35	UBC315G	Cloth	Green
\$1,002.84	UBF315BL	Foam	Blue
\$1,002.84	UBF315BK	Foam	Black
\$1,002.84	UBF315R	Foam	Red
\$1,002.84	UBF315G	Foam	Green

28" DELUXE VAN/SIDE WASHER PE163 FIVE STAR CAR WASH PECO

- 12" Diameter core
- 18 Channels x 28" high
- **CLOTH REPLACEMENT**
- 9 pcs: 13¾" x 23"/24" 1-ply w/1" slit
- 18 pcs: 13" x 6" one-play filter
- 9 pcs: 13¾" x 22"/23" 1-ply 1" slit

PRICE	PART#	MATERIAL	COLOR
\$288.79	UBC305BL	Cloth	Blue
\$288.79	UBC305BK	Cloth	Black
\$288.79	UBC305R	Cloth	Red
\$288.79	UBC305G	Cloth	Green
\$393.40	UBF305BL	Foam	Blue
\$393.40	UBF305BK	Foam	Black
\$393.40	UBF305R	Foam	Red
\$393.40	UBF305G	Foam	Green

35" DELUXE VAN/SIDE WASHER BOTTOM SECTION & DELUXE DETAIL SIDE WASHER PE135 FIVE STAR CAR WASH PECO®

- 12" Diameter core
- 36 Channels x 35" high
- **CLOTH REPLACEMENT**
- 36 pcs: 8" x 19" 1-ply
- 18 pcs: 18" x 19" 2-ply
- 18 pcs: 8" x 19" 2-ply
- 24 pcs: 17" x 6" 1-ply filter
- 18 pcs: 12" x 6" 1-ply filter

PRICE	PART#	MATERIAL	COLOR
\$857.31	UBC320BL	Cloth	Blue
\$857.31	UBC320BK	Cloth	Black
\$857.31	UBC320R	Cloth	Red
\$857.31	UBC320G	Cloth	Green
\$1,191.58	UBF320BL	Foam	Blue
\$1,191.58	UBF320BK	Foam	Black
\$1,191.58	UBF320R	Foam	Red
\$1,191.58	UBF320G	Foam	Green

48" SOFT FLEX WRAP AROUND PE372 TOP SECTION FIVE STAR CAR WASH PECO

- 12" Diameter core
- 10 Channels x 48" high
- **CLOTH REPLACEMENT**
- 10 pcs: 11⅝" x 20"/21½" 1-ply
- 10 pcs: 11⅝" x 21½"/23" 1-ply
- 10 pcs: 11⅝" x 23"/24½" 1-ply
- 10 pcs: 12½" x 24½"/26" 1-ply
- 10 pcs: 11⅝" x 5" 2-ply

PRICE	PART#	MATERIAL	COLOR
\$407.05	UBC310BL	Cloth	Blue
\$407.05	UBC310BK	Cloth	Black
\$407.05	UBC310R	Cloth	Red
\$407.05	UBC310G	Cloth	Green
\$654.91	UBF310BL	Foam	Blue
\$654.91	UBF310BK	Foam	Black
\$654.91	UBF310R	Foam	Red
\$654.91	UBF310G	Foam	Green

24" SOFT FLEX WRAP AROUND PE372 BOTTOM SECTION FIVE STAR CAR WASH PECO

- 12" Diameter core
- 36 Channels x 24" high
- **CLOTH REPLACEMENT**
- 24 pcs: 8" x 18" 1-ply
- 36 pcs: 16" x 18" 1-ply (Top 8" of pad is 2-ply)
- 12 pcs: Plastic Spacers

PRICE	PART#	MATERIAL	COLOR
\$666.28	UBC325BL	Cloth	Blue
\$666.28	UBC325BK	Cloth	Black
\$666.28	UBC325R	Cloth	Red
\$666.28	UBC325G	Cloth	Green
\$1,007.39	UBF325BL	Foam	Blue
\$1,007.39	UBF325BK	Foam	Black
\$1,007.39	UBF325R	Foam	Red
\$1,007.39	UBF325G	Foam	Green

REPLACEMENT CLOTH - BELANGER® MITTERS

FOAM AND CLOTH AVAILABLE IN THE FOLLOWING COLORS: ● ● ● ●

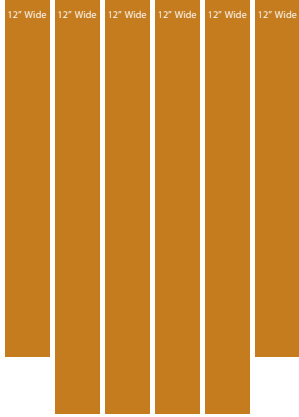

**WHIPPER SNAPPER
6 BASKET VAN LENGTH**
CLOTH REPLACEMENT FOR BELANGER

- CLOTH REPLACEMENT
- 24 pcs: 12" x 76" with 6" slit
- 24 pcs: 12" x 94" with 4" slit
- 24 pcs: 12" x 94" with 3" slit

PRICE	PART#	COLOR
\$1,660.02	UBCM103BL	Blue
\$1,660.02	UBCM103BK	Black
\$1,660.02	UBCM103R	Red
\$1,660.02	UBCM103G	Green

ROD STYLE

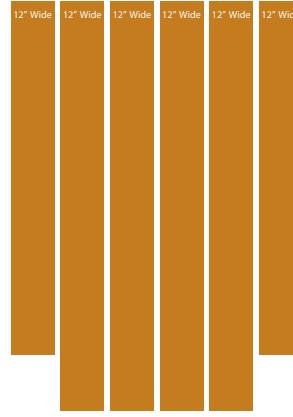

**WHIPPER SNAPPER
6 BASKET CAR LENGTH**
CLOTH REPLACEMENT FOR BELANGER

- CLOTH REPLACEMENT
- 24 pcs: 12" x 58" with 6" slit
- 24 pcs: 12" x 76" with 4" slit
- 24 pcs: 12" x 76" with 3" slit

PRICE	PART#	COLOR
\$1,432.61	UBCM143BL	Blue
\$1,432.61	UBCM143BK	Black
\$1,246.15	UBCM143R	Red
\$1,432.61	UBCM143G	Green

ROD STYLE

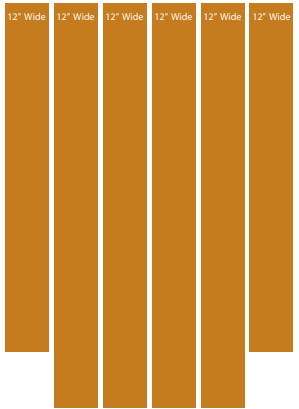

**WHIPPER SNAPPER
4 BASKET VAN LENGTH**
CLOTH REPLACEMENT FOR BELANGER

- CLOTH REPLACEMENT
- 16 pcs: 12" x 76" with 6" slit
- 16 pcs: 12" x 94" with 4" slit
- 16 pcs: 12" x 94" with 3" slit

PRICE	PART#	COLOR
\$1,107.44	UBCM113BL	Blue
\$1,107.44	UBCM113BK	Black
\$1,107.44	UBCM113R	Red
\$1,107.44	UBCM113G	Green

ROD STYLE

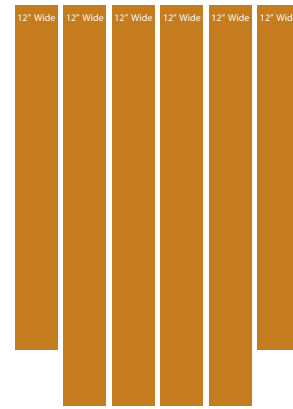

**WHIPPER SNAPPER
4 BASKET CAR LENGTH**
CLOTH REPLACEMENT FOR BELANGER

- CLOTH REPLACEMENT
- 16 pcs: 12" x 58" with 6" slit
- 16 pcs: 12" x 76" with 4" slit
- 16 pcs: 12" x 76" with 3" slit

PRICE	PART#	COLOR
\$973.27	UBCM153BL	Blue
\$973.27	UBCM153BK	Black
\$973.27	UBCM153R	Red
\$973.27	UBCM153G	Green

ROD STYLE

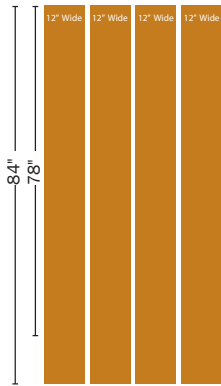

**WHIPPER ACROSS 600
2' WIDE BASKET**
CLOTH REPLACEMENT FOR BELANGER

- CLOTH REPLACEMENT
- 32 pcs: 12" x 78" with 3" slit
- 32 pcs: 12" x 84" with 3" slit

PRICE	PART#	COLOR
\$1,421.25	UBCM123BL	Blue
\$1,421.25	UBCM123BK	Black
\$1,421.25	UBCM123R	Red
\$1,421.25	UBCM123G	Green

ROD STYLE

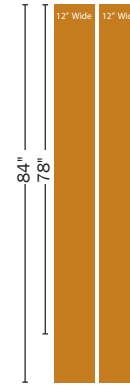

**WHIPPER ACROSS 310
1' WIDE BASKET**
CLOTH REPLACEMENT FOR BELANGER

- CLOTH REPLACEMENT
- 16 pcs: 12" x 78" with 3" slit
- 16 pcs: 12" x 84" with 3" slit

PRICE	PART#	COLOR
\$725.41	UBCM163BL	Blue
\$725.41	UBCM163BK	Black
\$725.41	UBCM163R	Red
\$725.41	UBCM163G	Green

ROD STYLE

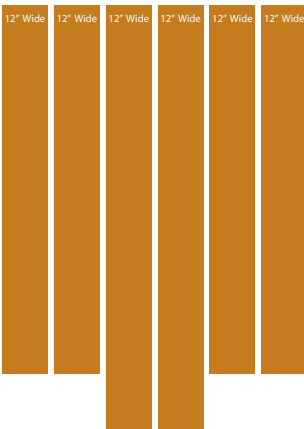

**WHIP ACROSS 802
COMBO MODULE**
CLOTH REPLACEMENT FOR BELANGER

- CLOTH REPLACEMENT
- 16 pcs: 12" x 76" with 6" slit
- 16 pcs: 12" x 76" with 4" slit
- 16 pcs: 12" x 94" with 3" slit

PRICE	PART#	COLOR
\$1,082.41	UBCM133BL	Blue
\$1,082.41	UBCM133BK	Black
\$1,082.41	UBCM133R	Red
\$1,082.41	UBCM133G	Green

ROD STYLE

**DOUBLE CROSS
VAN LENGTH**
CLOTH REPLACEMENT FOR BELANGER

- CLOTH REPLACEMENT
- 48 pcs: 12" x 78" with 3" slit

PRICE	PART#	COLOR
\$1,030.13	UBCM173BL	Blue
\$1,030.13	UBCM173BK	Black
\$1,030.13	UBCM173R	Red
\$1,030.13	UBCM173G	Green

ROD STYLE

**DOUBLE CROSS
CAR LENGTH**
CLOTH REPLACEMENT FOR BELANGER

- CLOTH REPLACEMENT
- 48 pcs: 12" x 60" with 3" slit

PRICE	PART#	COLOR
\$866.40	UBCM183BL	Blue
\$866.40	UBCM183BK	Black
\$866.40	UBCM183R	Red
\$866.40	UBCM183G	Green

ROD STYLE

FOAM AND CLOTH AVAILABLE IN THE FOLLOWING COLORS: ● ● ● ●

REPLACEMENT CLOTH - ECONOCRAFT® MITTERS

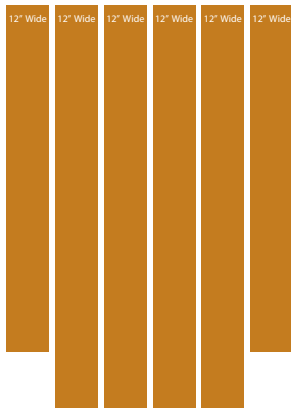

WHIPPER SNAPPER 6 BASKET VAN LENGTH CLOTH REPLACEMENT FOR ECONOCRAFT

- CLOTH REPLACEMENT
- 24 pcs: 12" x 76" with 6" slit
- 24 pcs: 12" x 94" with 4" slit
- 24 pcs: 12" x 94" with 3" slit

PRICE	PART#	COLOR
\$1,660.02	UBCM203BL	Blue
\$1,660.02	UBCM203BK	Black
\$1,660.02	UBCM203R	Red
\$1,660.02	UBCM203G	Green

ROD STYLE

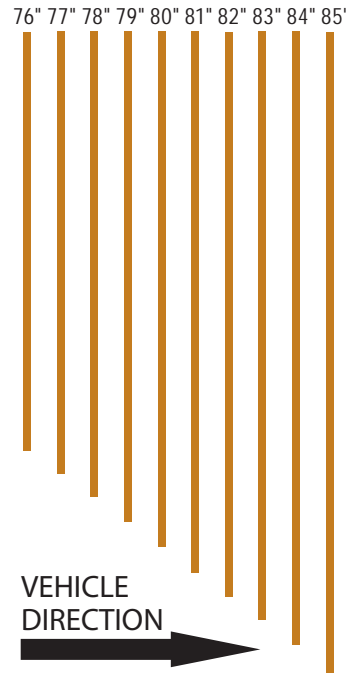

10 ROW MITTER VAN LENGTH CLOTH REPLACEMENT FOR ECONOCRAFT

- CLOTH REPLACEMENT
- 8 pcs: 12" x 85" with 3" slit
- 8 pcs: 12" x 84" with 3" slit
- 8 pcs: 12" x 83" with 3" slit
- 8 pcs: 12" x 82" with 3" slit
- 8 pcs: 12" x 81" with 3" slit
- 8 pcs: 12" x 80" with 3" slit
- 8 pcs: 12" x 79" with 3" slit
- 8 pcs: 12" x 78" with 3" slit
- 8 pcs: 12" x 77" with 3" slit
- 8 pcs: 12" x 76" with 3" slit

PRICE	PART#	COLOR
\$1,787.36	UBCM223BL	Blue
\$1,787.36	UBCM223BK	Black
\$1,787.36	UBCM223R	Red
\$1,787.36	UBCM223G	Green

LOOPED & SEWN

SIDE TO SIDE MITTER VAN LENGTH

CLOTH REPLACEMENT FOR ECONOCRAFT

- CLOTH REPLACEMENT
- 64 pcs: 12" x 94" with 3" slit

LOOPED & SEWN

PRICE	PART#	COLOR
\$1,628.19	UBCM213BL	Blue
\$1,628.19	UBCM213BK	Black
\$1,628.19	UBCM213R	Red
\$1,628.19	UBCM213G	Green

REPLACEMENT CLOTH - PECO® MITTERS

FOAM AND CLOTH AVAILABLE IN THE FOLLOWING COLORS: ● ● ● ●

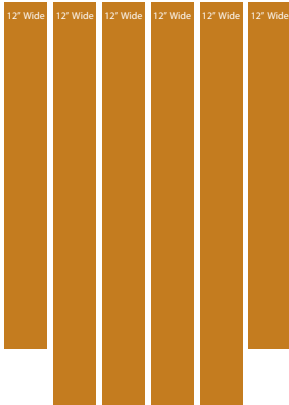

MC04 MINI-WASH ACROSS MITTER CLOTH REPLACEMENT FOR PECO

- CLOTH REPLACEMENT
- 16 pcs: 12" x 72" with 3" slit & 1" Loop
- 32 pcs: 12" x 80" with 3" slit & 1" Loop

PRICE	PART#	COLOR
\$1,032.39	UBCM303BL	Blue
\$1,032.39	UBCM303BK	Black
\$1,032.39	UBCM303R	Red
\$1,032.39	UBCM303G	Green

LOOPED & SEWN

MC02 MINI-WASH ACROSS MITTER CLOTH REPLACEMENT FOR PECO

- CLOTH REPLACEMENT
- 32 pcs: 9" x 78" with 3" slit & 1" Loop

LOOPED & SEWN

PRICE	PART#	COLOR
\$552.58	UBCM323BL	Blue
\$552.58	UBCM323BK	Black
\$552.58	UBCM323R	Red
\$552.58	UBCM323G	Green

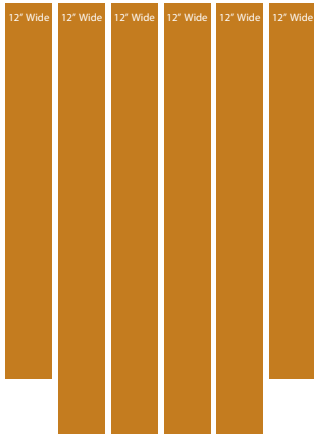

MC06 WASH-ALONG MITTER CLOTH REPLACEMENT FOR PECO

- CLOTH REPLACEMENT
- 24 pcs: 12" x 72" with 3" slit & 1" Loop
- 48 pcs: 12" x 80" with 3" slit & 1" Loop

PRICE	PART#	COLOR
\$1,546.33	UBCM313BL	Blue
\$1,546.33	UBCM313BK	Black
\$1,546.33	UBCM313R	Red
\$1,546.33	UBCM313G	Green

LOOPED & SEWN

MC08 WASH-ALONG MITTER CLOTH REPLACEMENT FOR PECO

- CLOTH REPLACEMENT
- 64 pcs: 9" x 78" with 3" slit & 1" Loop

LOOPED & SEWN

PRICE	PART#	COLOR
\$1,114.27	UBCM333BL	Blue
\$1,114.27	UBCM333BK	Black
\$1,114.27	UBCM333R	Red
\$1,114.27	UBCM333G	Green

MC35 WASH-A-DIAGONAL MITTER CLOTH REPLACEMENT FOR PECO

- CLOTH REPLACEMENT
- 16 pcs: 9" x 78" with 3" slit & 1" Loop
- 24 pcs: 12" x 80" with 3" slit & 1" Loop

LOOPED & SEWN

PRICE	PART#	COLOR
\$807.28	UBCM343BL	Blue
\$807.28	UBCM343BK	Black
\$807.28	UBCM343R	Red
\$807.28	UBCM343G	Green

REPLACEMENT CLOTH - SONNY'S® MITTERS

FOAM AND CLOTH AVAILABLE IN THE FOLLOWING COLORS: ● ● ● ●

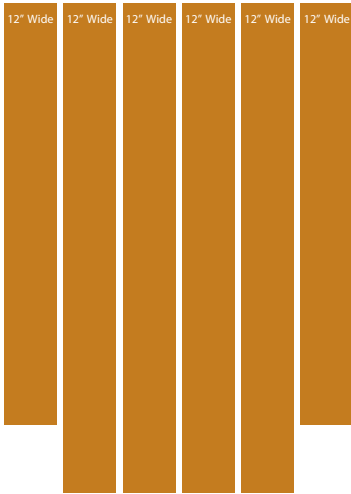

SFM100 & 104 FRONT TO BACK MITTER 6 BASKET LENGTH

CLOTH REPLACEMENT FOR SONNY'S

- CLOTH REPLACEMENT
- 24 pcs: 12" x 76" with 3" slit
- 48 pcs: 12" x 94" with 3" slit

PRICE	PART#	COLOR
\$1,660.02	UBCM503BL	Blue
\$1,660.02	UBCM503BK	Black
\$1,660.02	UBCM503R	Red
\$1,660.02	UBCM503G	Green

LOOPED & SEWN

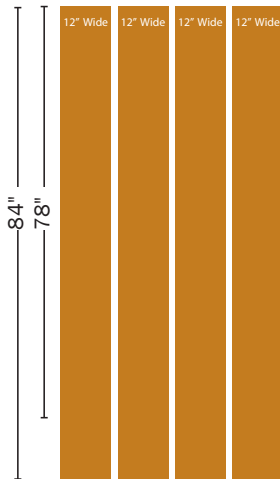

SFM802 SIDE TO SIDE MITTER 2' WIDE BASKET VAN LENGTH

CLOTH REPLACEMENT FOR SONNY'S

- CLOTH REPLACEMENT
- 32 pcs: 12" x 78" with 3" slit
- 32 pcs: 12" x 84" with 3" slit

PRICE	PART#	COLOR
\$1,428.07	UBCM543BL	Blue
\$1,428.07	UBCM543BK	Black
\$1,428.07	UBCM543R	Red
\$1,428.07	UBCM543G	Green

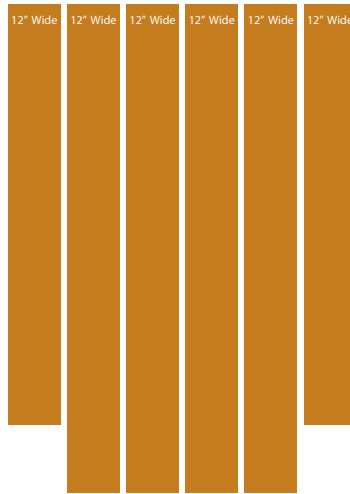

SFM100 & 104 FRONT TO BACK MITTER 4 BASKET VAN LENGTH

CLOTH REPLACEMENT FOR SONNY'S

- CLOTH REPLACEMENT
- 16 pcs: 12" x 76" with 3" slit
- 32 pcs: 12" x 94" with 3" slit

PRICE	PART#	COLOR
\$1,164.29	UBCM533BL	Blue
\$1,164.29	UBCM533BK	Black
\$1,164.29	UBCM533R	Red
\$1,164.29	UBCM533G	Green

LOOPED & SEWN

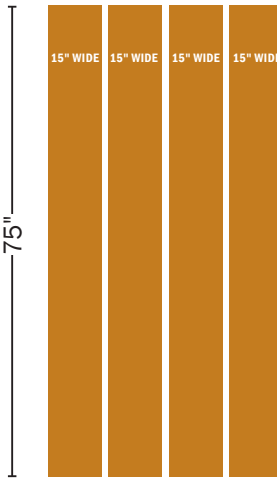

SFM202 MITTER FRONT TO BACK CURVED BASKET VAN LENGTH

CLOTH REPLACEMENT FOR SONNY'S

- CLOTH REPLACEMENT
- 42 pcs: 15" x 75" with 3" slit

PRICE	PART#	COLOR
\$1,102.88	UBCM523BL	Blue
\$1,102.88	UBCM523BK	Black
\$1,102.88	UBCM523R	Red
\$1,102.88	UBCM523G	Green

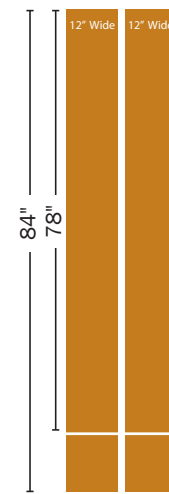

SFM801 SIDE TO SIDE MITTER 1" WIDE BASKET VAN LENGTH

CLOTH REPLACEMENT FOR SONNY'S

- CLOTH REPLACEMENT
- 16 pcs: 12" x 78" with 3" slit
- 16 pcs: 12" x 84" with 3" slit

PRICE	PART#	COLOR
\$727.69	UBCM513BL	Blue
\$727.69	UBCM513BK	Black
\$727.69	UBCM513R	Red
\$727.69	UBCM513G	Green

LOOPED & SEWN

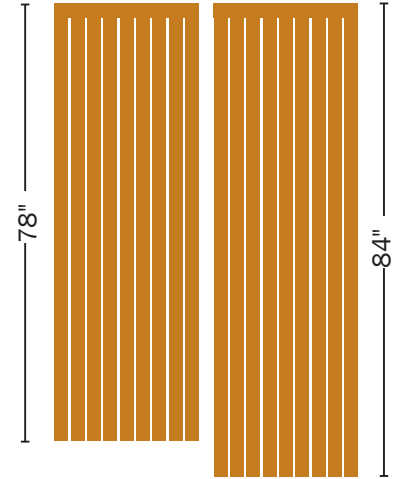

SFM804 MITTER SIDE TO SIDE CURVED BASKET VAN LENGTH

CLOTH REPLACEMENT FOR SONNY'S

- CLOTH REPLACEMENT
- 14 pcs: 18" x 78" with 3" slit
- 14 pcs: 18" x 84" with 3" slit

PRICE	PART#	COLOR
\$986.92	UBCM553BL	Blue
\$986.92	UBCM553BK	Black
\$986.92	UBCM553R	Red
\$986.92	UBCM553G	Green

AUTOMATICS & TUNNELS

FOAM & CLOTHS

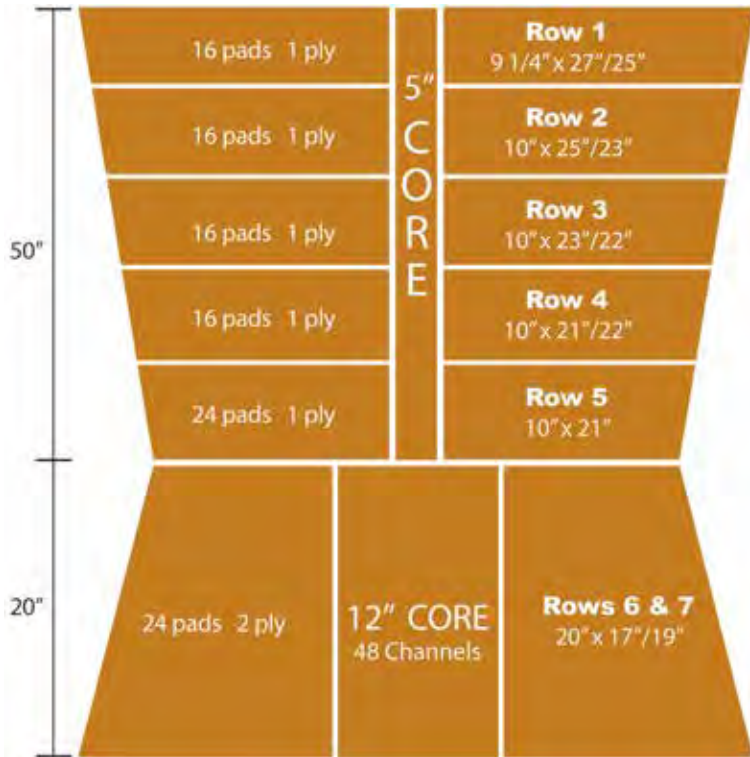

Double Stitched and Reinforced Top

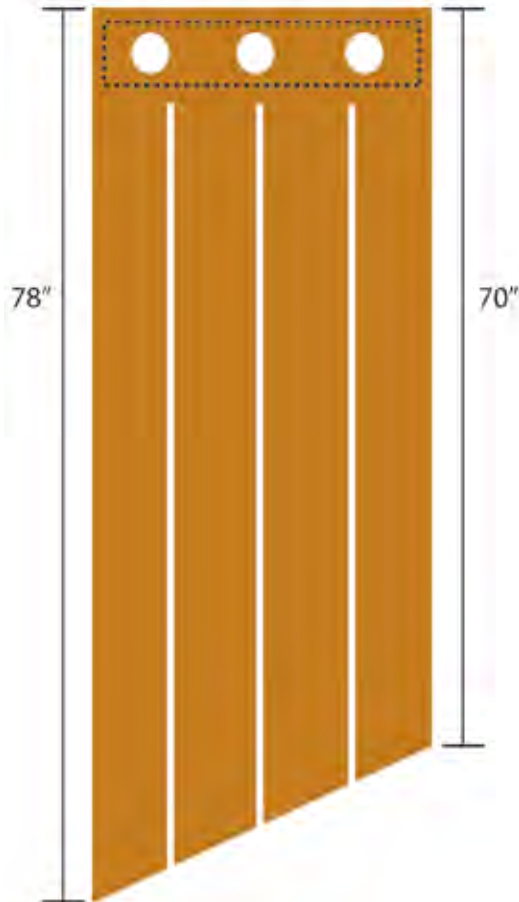

FOAM REPLACEMENTS FOR AUTEC® BRUSHES & CURTAINS

FOAM AND CLOTH AVAILABLE IN THE FOLLOWING COLORS: ● ● ● ●

COMPLETE REPLACEMENT SET FOR 4 BRUSHES & CURTAINS

FOAM REPLACEMENT FOR AUTEC

• A COMPLETE REPLACEMENT SET FOR 4 BRUSHES & CURTAINS REQUIRES THE FOLLOWING:

- 56 pcs: Row 1
- 56 pcs: Row 2
- 56 pcs: Row 3
- 56 pcs: Row 4
- 96 pcs: Row 5
- 96 pcs: Row 6 & 7
- 44 pcs: Curtains

• OR CHOOSE SINGLE REPLACEMENTS FROM CHART BELOW

ROW	SIZE	COLOR	PART #	PRICE
1	9 1/4" x 27"/25" Taper Trim Foam	Blue	UBF600BL	\$14.12 EACH
		Red	UBF600R	
		Black	UBF600BK	
		Green	UBF600G	
2	10" x 25"/23 1/2" Taper Trim Foam	Blue	UBF605BL	\$13.53 EACH
		Red	UBF605R	
		Black	UBF605BK	
		Green	UBF605G	
3	10" x 23.5"/22" Taper Trim Foam	Blue	UBF610BL	\$13.24 EACH
		Red	UBF610R	
		Black	UBF610BK	
		Green	UBF610G	
4	10" x 22"/21" Taper Trim Foam	Blue	UBF615BL	\$12.65 EACH
		Red	UBF615R	
		Black	UBF615BK	
		Green	UBF615G	
5	10" x 21" Trim Foam	Blue	UBF620BL	\$12.35 EACH
		Red	UBF620R	
		Black	UBF620BK	
		Green	UBF620G	
6 & 7	20" x 17"/20" Taper (2 ply) Foam	Blue	UBF625BL	\$37.06 EACH
		Red	UBF625R	
		Black	UBF625BK	
		Green	UBF625G	

Curtain	12" x 78"/70" Tapered 3" Slit Drop Cloth	Blue	UBC630BL	\$28.24 EACH
		Red	UBC630R	
		Black	UBC630BK	
		Green	UBC630G	



AUTOMATICS & TUNNELS

FOAM & CLOTHS

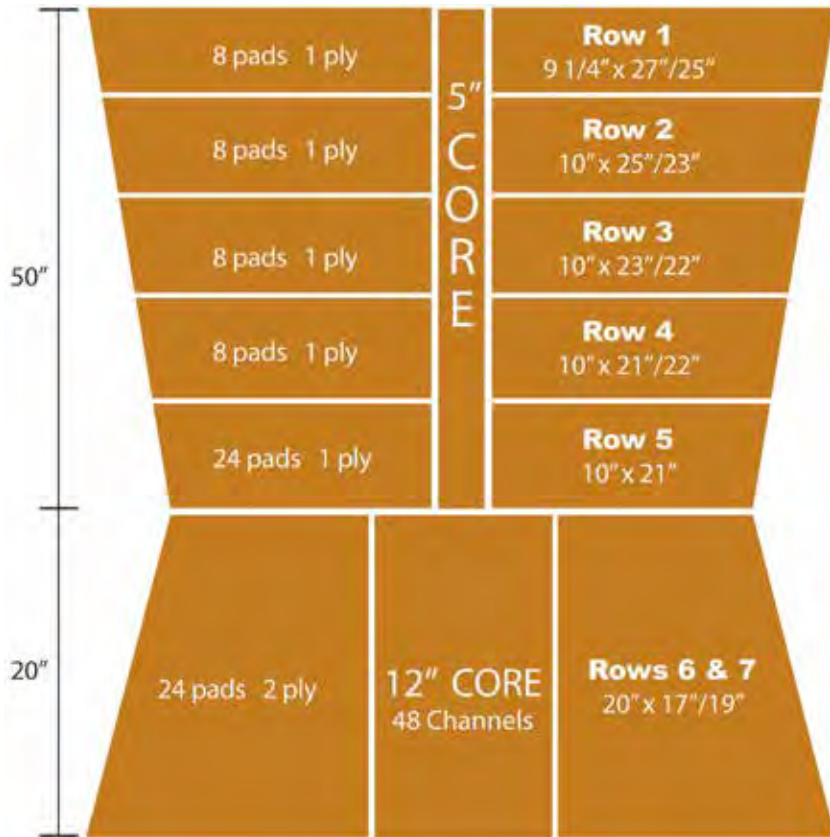

Double Stitched and Reinforced Top

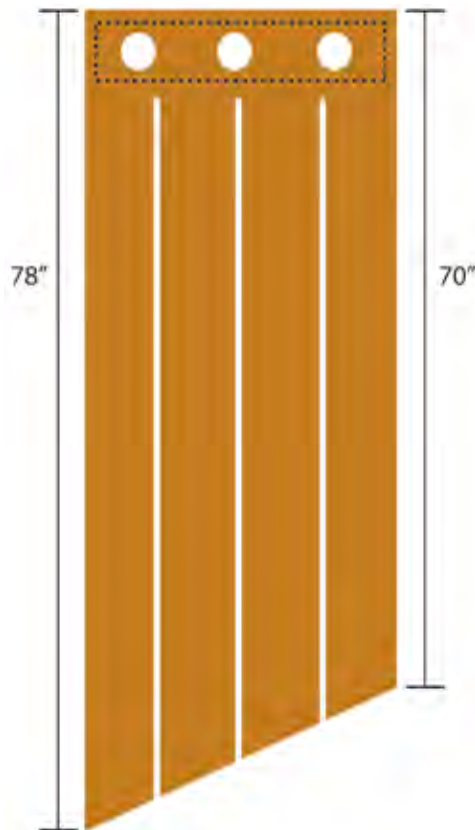

CLOTH REPLACEMENTS FOR ATEC® BRUSHES & CURTAINS

FOAM AND CLOTH AVAILABLE IN THE FOLLOWING COLORS: ● ● ● ●

COMPLETE REPLACEMENT SET FOR 4 BRUSHES & CURTAINS

CLOTH REPLACEMENT FOR ATEC

• A COMPLETE REPLACEMENT SET FOR 4 BRUSHES & CURTAINS REQUIRES THE FOLLOWING:

- 32 pcs: Row 1
- 32 pcs: Row 2
- 32 pcs: Row 3
- 32 pcs: Row 4
- 96 pcs: Row 5
- 96 pcs: Row 6 & 7
- 44 pcs: Curtains
- 96 pcs: Buffers

• OR CHOOSE SINGLE REPLACEMENTS FROM CHART BELOW

ROW	SIZE	COLOR	PART #	PRICE
1	9 1/4" x 27"/25" Taper Trim Cloth	Blue	UBC600BL	\$10.29 EACH
		Red	UBC600R	
		Black	UBC600BK	
		Green	UBC600G	
2	10" x 25"/23 1/2" Taper Trim Cloth	Blue	UBC605BL	\$9.88 EACH
		Red	UBC605R	
		Black	UBC605BK	
		Green	UBC605G	
3	10" x 23 1/2"/22" Taper Trim Cloth	Blue	UBC610BL	\$9.53 EACH
		Red	UBC610R	
		Black	UBC610BK	
		Green	UBC610G	
4	10" x 22"/21" Taper Trim Cloth	Blue	UBC615BL	\$9.24 EACH
		Red	UBC615R	
		Black	UBC615BK	
		Green	UBC615G	
5	10" x 21" Trim Cloth	Blue	UBC620BL	\$9.00 EACH
		Red	UBC620R	
		Black	UBC620BK	
		Green	UBC620G	
6 & 7	20" x 17"/20" Taper (2 ply) Cloth	Blue	UBC625BL	\$27.06 EACH
		Red	UBC625R	
		Black	UBC625BK	
		Green	UBC625G	

Curtain	12" x 78"/70" Tapered 3" Slit Drop Cloth	Blue	UBC630BL	\$28.24 EACH
		Red	UBC630R	
		Black	UBC630BK	
		Green	UBC630G	

Buffer	20" x 5" (2 ply)	Blue	UBC635BL	\$9.00 EACH
		Red	UBC635R	
		Black	UBC635BK	
		Green	UBC635G	



BE PRESSURE WASHERS



PE-4013HWPAGEN GAS PRESSURE WASHER

BE PRESSURE

SPECIFICATIONS:

- **FLOW:** 4 GPM
- **MAX. PRESSURE:** 4,000 PSI
- **HP:** 13
- **ENGINE:** 389cc Honda GX390
- **PUMP:** General EZ4040G Triplex Pump

STANDARD ACCESSORIES/FEATURES:

- 50' high-pressure hose
- Industrial grade spray gun
- Low-pressure chemical injector
- 4 quick-connect nozzles: 0°, 15°, 40°, Soaper
- 12" flat free tires

\$1,308.33 PWH1344AGEN



B4013HABG GAS PRESSURE WASHER

BE PRESSURE

SPECIFICATIONS:

- **FLOW:** 4 GPM
- **MAX. PRESSURE:** 4000 PSI
- **HP:** 13
- **ENGINE:** 389cc Honda GX390
- **PUMP:** General TSS1511 Triplex Pump

STANDARD ACCESSORIES/FEATURES:

- 50' high-pressure hose
- Industrial grade spray gun
- Low-pressure chemical injector
- 4 quick-connect nozzles: 0°, 15°, 40°, Soaper
- 12" flat free tires

\$1,665.48 B4013HABG



B4014KABG GAS PRESSURE WASHER

BE PRESSURE

SPECIFICATIONS:

- **FLOW:** 4 GPM
- **MAX. PRESSURE:** 4000 PSI
- **HP:** 11
- **ENGINE:** 429cc Kohler CH440
- **PUMP:** General TSS1511 Triplex Pump

STANDARD ACCESSORIES/FEATURES:

- 50' high-pressure hose
- Industrial grade spray gun
- Low-pressure chemical injector
- 4 quick-connect nozzles: 0°, 15°, 40°, Soaper
- 12" flat free tires

\$1,629.76 B4014KABG



B4414KGS GAS PRESSURE WASHER

BE PRESSURE

SPECIFICATIONS:

- **FLOW:** 4 GPM
- **MAX. PRESSURE:** 4000 PSI
- **HP:** 11
- **ENGINE:** 429cc Kohler CH440
- **PUMP:** General EZ4040G Triplex Pump

STANDARD ACCESSORIES/FEATURES:

- 50' high-pressure hose
- Industrial grade spray gun
- Low-pressure chemical injector
- 4 quick-connect nozzles: 0°, 15°, 40°, Soaper
- 12" flat free tires

\$1,142.86 B4414KGS

PRESSURE WASH

BE

BE PRESSURE WASHERS



B4013HCS GAS PRESSURE WASHER

BE PRESSURE

SPECIFICATIONS:

- **FLOW:** 4 GPM
- **MAX. PRESSURE:** 4,000 PSI
- **HP:** 13
- **ENGINE:** 389cc Honda GX390
- **PUMP:** Comet ZWD4040G Triplex Pump

STANDARD ACCESSORIES/FEATURES:

- 50' high-pressure hose
- Industrial grade spray gun
- Low-pressure chemical injector
- 4 quick-connect nozzles: 0°, 15°, 40°, Soaper
- 12" flat free tires

\$1,153.57

B4013HCS



B2565KGS GAS PRESSURE WASHER

BE PRESSURE

SPECIFICATIONS:

- **FLOW:** 3 GPM
- **MAX. PRESSURE:** 2,500 PSI
- **ENGINE:** 196cc Kohler SH270
- **PUMP:** General TJ2530J34 Triplex Pump

STANDARD ACCESSORIES/FEATURES:

- 50' high-pressure hose
- 36" Industrial grade spray gun wand
- Low-pressure chemical injector
- 4 quick-connect nozzles: 0°, 15°, 40°, Soaper
- 10" flat free tires

\$820.24

B2565KGS

Since 1959, Kleen-Rite has been providing high quality products and personalized service to countless satisfied business owners. Whether you are starting a new power washing company, or have been in the business for decades like us, we're here to help!

Our fully trained staff is ready to assist you in choosing the best products for your operation. We offer year-round low pricing on equipment, supplies, soaps, and more – so you can save money on every order.

BE PRESSURE WASHERS



B205EA PRESSURE WASHER

BE PRESSURE

SPECIFICATIONS:

- **FLOW:** 3½ GPM
- **MAX. PRESSURE:** 2000 PSI
- **HP:** 5
- **PHASE:** Single
- **ENGINE:** 220V Baldor Electric
- **PUMP:** AR North America

STANDARD ACCESSORIES/FEATURES:

- 36" spray lance insulated grip
- 50' high-pressure hose, 3/8" hose
- Low-pressure chemical injector
- 12" pneumatic tires

\$1,352.37 **PWE5352AR**

**Power cord, plug and switch
NOT INCLUDED - needs to be hard-wired by Electrician!**



B153EA PRESSURE WASHER

BE PRESSURE

SPECIFICATIONS:

- **FLOW:** 3 GPM
- **MAX. PRESSURE:** 1500 PSI
- **HP:** 3
- **PHASE:** Single
- **ENGINE:** 240V Baldor Electric
- **PUMP:** AR North America Triplex JRV2G25E

STANDARD ACCESSORIES/FEATURES:

- 4 quick-connect nozzles
- Rear entry spray gun w/ easy 3/8" quick connector
- 36" spray lance insulated grip
- 50' high-pressure hose, 3/8" hose
- Low-pressure chemical injector
- 12" flat free
- 6.5", 12 gauge power cord for motor

\$1,073.19 **PWH332COM**

**Power cord, plug and switch
NOT INCLUDED - needs to be hard-wired by Electrician!**



PE-1520EW1A PRESSURE WASHER

BE PRESSURE

SPECIFICATIONS:

- **FLOW:** 2 GPM
- **MAX. PRESSURE:** 1500 PSI
- **HP:** 2
- **PHASE:** Single
- **ENGINE:** 120V Baldor
- **PUMP:** AR North America Triplex JRV2G25E

STANDARD ACCESSORIES/FEATURES:

- Triplex pump with chemical injector and built-in unloader
- 25' high-pressure hose
- Split wand assembly with gun
- 0°, 15°, 40°, and chemical quick connect nozzles
- 10" Flat free tires

\$973.38 **PWE2215AR**



X-2050FW1A WALL MOUNTED PRESSURE WASHER

BE PRESSURE

SPECIFICATIONS:

- **FLOW:** 4 GPM
- **MAX. PRESSURE:** 2000 PSI
- **HP:** 5
- **PHASE:** Single
- **ENGINE:** 230V Baldor Electric
- **PUMP:** AR RRA35G30E Triplex

STANDARD ACCESSORIES/FEATURES:

- Low-pressure chemical injector
- 50' high-pressure steel braided hose
- 36" Gun, wand, and couplings
- Automatic shutdown system

\$2,467.00 **PWE542COM**

WALL MOUNTED

PRESSURE WASH



BE PRESSURE WASHERS



PWH13354CAT

B4013 PRESSURE WASHER

BE PRESSURE

SPECIFICATIONS:

- **FLOW:** 4 GPM
- **MAX. PRESSURE:** 4000 PSI
- **PUMP:** Varies - See Specific Model
- **HP:** 13
- **ENGINE:** Honda GX390

STANDARD ACCESSORIES/FEATURES:

- 50' 3/8" steel braid hose
- 36" gun/wand assembly
- #3.5 quick connect nozzles: 0°, 15°, 40°, soaper
- Split lance, O-Ring

PRICE	KR #	MFG SERIES	PUMP
\$1,438.30	PWH13354CAT	B4013HJS	66DX40GG1 CAT Pump
\$1,322.95	PWH1343G	B4013HGS	EZ4040G General Pump Triplex Pump



PWH1344COMZ

PE-4013HWPS PRESSURE WASHER

BE PRESSURE

SPECIFICATIONS:

- **FLOW:** 4 GPM
- **MAX. PRESSURE:** 4000 PSI
- **PUMP:** Varies - See Specific Model
- **HP:** 13
- **ENGINE:** Honda GX390

STANDARD ACCESSORIES/FEATURES:

- 50' 3/8" high-pressure steel braided hose
- Wand assembly/gun/couplings
- #4 quick connect nozzles: 0°, 15°, 40°, soaper
- Low-pressure chemical injector
- 1" keyed shaft

PRICE	KR #	MFG SERIES	PUMP
\$1,322.95	PWH1344COMZ	PE-4013HWPSCOMZ	Comet ZWD4040G Triplex Pump
\$1,641.48	PWH4013CAT	PE-4013HWPSCAT	CAT 66DX40GG1 Triplex Pump



BE317RA PRESSURE WASHER

BE PRESSURE

SPECIFICATIONS:

- **FLOW:** 2.5 GPM
- **MAX PRESSURE:** 3100 PSI
- **PUMP:** AR RMV25G30D-EZ
- **HP:** 13
- **ENGINE:** Powerease 225

STANDARD ACCESSORIES/FEATURES:

- 1/4" 25' thermoplastic hose
- Spray gun with a 36" lance
- 0°, 15°, 40° nozzles and soaper
- M22 threaded fittings

\$454.33	BE317RA
-----------------	----------------



B3065HJ PRESSURE WASHER

BE PRESSURE

SPECIFICATIONS:

- **FLOW:** 3 GPM
- **MAX. PRESSURE:** 2500 PSI
- **PUMP:** CAT 4DNX27G51 Triplex Pump
- **HP:** 6.5
- **ENGINE:** Honda GX200

STANDARD ACCESSORIES/FEATURES:

- 1/4" 25' high-pressure steel braided hose
- Split wand assembly with gun
- #3.5 quick connect nozzles: 0°, 15°, 40°, soaper
- Split lance, O-Ring

\$899.23	PWH65325C
-----------------	------------------

PRESSURE WASH

PRESSURE WASHERS

WALL MOUNTED EAGLE SERIES DIRECT DRIVE PRESSURE WASHERS

PRESSURE-PRO



PW6100

SPECIFICATIONS:

- **FLOW:** Varies - see specific model
- **MAX. PRESSURE:** Varies - see specific model
- **PHASE:** Single
- **HP:** Varies - see specific model
- **ENGINE:** Varies - see specific model

STANDARD ACCESSORIES:

- Gun/wand assembly with insulated grip and quick connects
- 50' high-pressure hose w/quick connects
- Chemical injector assembly with quick connects.
- 4 color-coded QC spray nozzles
- 1 color-coded QC chemical nozzle

PRICE	KR #	MFG SERIES	PUMP	MOTOR	HP	PH	PSI	GPM
\$1,228.38	PW6100	WM/EE2015G	TT9061EBF General Pump	K615 115V Marathon Motor	2	1	1500	2
\$1,533.80	PW6110	WM/EE2015C.3	2SF20ES.3 Cat Pump	K615 115V Marathon Motor	2	1	1500	2
\$1,633.97	PW6260	WM/EE3015G	TT9071EBFL General Pump	K618 230V Marathon Motor	3	1	1500	3

GAS POWERED PRESSURE WASHERS

EAGLE EB4040HC BELT DRIVE PRESSURE WASHER

PRESSURE-PRO



PW6200

SPECIFICATIONS:

- **FLOW:** 4 GPM
- **MAX. PRESSURE:** 4000 PSI
- **PUMP:** Varies, see specific model
- **ENGINE:** Honda GX390

STANDARD ACCESSORIES:

- Gun/wand assembly w/quick connects
- 50' high-pressure hose w/quick connects
- Chemical injector
- 4 color-coded QC spray nozzles
- 1 color-coded QC chemical nozzle

PRICE	KR #	MFG SERIES	PUMP
\$2,211.73	PW6200	EB4040HC	5PP3140 CAT Triplex Plunger Pump
\$1,912.41	PW6190	EB4040HG	HP4040 General Pump
\$1,829.82	PW6180	EB4040HA	RKA4G40 AR North America Pump

GAS POWERED

EAGLE 3027HG DIRECT DRIVE PRESSURE WASHER

PRESSURE-PRO



PW6230

SPECIFICATIONS:

- **FLOW:** 3 GPM
- **MAX. PRESSURE:** 2700 PSI
- **HP:** 6.5
- **PUMP:** Varies, see specific model
- **ENGINE:** Honda GX200

STANDARD ACCESSORIES:

- Gun/wand assembly w/quick connects
- 50' high-pressure hose w/quick connects
- Chemical injector
- 4 color-coded QC spray nozzles
- 1 color-coded QC chemical nozzle

PRICE	KR #	MFG SERIES	PUMP
\$1,096.99	PW6230	E3027HG	TP2530J34 General Pump
\$1,050.96	PW6225	E3027HC	4PPX30GSI CAT Triplex Plunger Pump

GAS POWERED

GAS POWERED PRESSURE WASHER ACCESSORIES



5-GALLON SMART-FILL POLY GAS CANS

GARAGE BOSS

- For use with gas-powered equipment for efficient refueling
- Smart-Fill spout facilitates easier refueling
- Ergonomic design
- Dust cap protects contents

\$35.76 **PWP8002**

PRESSURE WASH

SPRAY GUNS

KLEEN-RITE CORP.

Swapping out a new spray gun, hose, wand and couplings has never been easier with this handy all inclusive bundle pack. Everything needed in one convenient pack.



SPRAY GUN KIT

KLEEN-RITE

KIT INCLUDES:

- 1 - Non-Weep Trigger Spray Gun
- 1 - 36" Zinc Plated Spray Wand
- 1 - 50' of 3/8" Wire Braid HP Hose
- 1 - 1/4" F Quick Disconnect Socket
- 1 - 3/8" F Quick Disconnect Socket
- 1 - 3/8" Quick Disconnect M Plug
- 1 - 3/8" Quick Disconnect F Plug

\$164.64 KRK3150

NON-WEEP

BEST VALUE GUN

KLEEN-RITE

KLEEN-RITE



- Interchangeable with CAT 32121 parts
- **MAX FLOW:** 10.5 GPM
- **MAX PRESSURE:** 4000 PSI
- **MAX TEMP.:** 300°F
- **INLET:** 3/8" FPT
- **OUTLET:** 1/4" FPT

\$28.01 GUK600NW Gun
\$13.14 GUK600K Repair Kit

NON-WEEP



STRAIGHT GRIP GUN

KLEEN-RITE

KLEEN-RITE

- Brass discharge fitting
- **MAX FLOW:** 10.5 GPM
- **MAX PRESSURE:** 4000 PSI
- **MAX TEMP.:** 300°F
- **REAR INLET:** 3/8" FPT
- **OUTLET:** 1/4" FPT

\$47.95 GUK700NW Gun
\$11.75 GUK700NWK Repair Kit

NON-WEEP



ST-1500 SERIES

SUTTNER

SUTTNER

- **MAX FLOW:** 5000 PSI @ 10.4 GPM
- **MAX TEMP.:** 300°F
- **INLET:** 3/8"
- **OUTLET:** 1/4"

\$23.85 SUT1500NW Gun
\$9.38 SUT1500NWK Repair Kit

NON-WEEP



ST-1500 SERIES

SUTTNER

SUTTNER

- Great for even small hands!
- **MAX FLOW:** 5000 PSI @ 10.4 GPM
- **INLET:** 3/8"
- **OUTLET:** 1/4"

\$29.70 SUT1500NW-SS

NON-WEEP



ST-1100 SERIES

SUTTNER

SUTTNER

- 15 oz. lightweight gun!
- **MAX FLOW:** 7.0 GPM
- **MAX PRESSURE:** 3050 PSI
- **MAX TEMP.:** 300°F
- **INLET:** 3/8"
- **OUTLET:** 1/4"

\$23.27 SUT1100NW Gun
\$11.45 SUT1100NWK Repair Kit

NON-WEEP



ST-2300 SERIES

SUTTNER

SUTTNER

- "Relax action" for easy trigger pull
- **MAX FLOW:** 12.0 GPM
- **MAX PRESSURE:** 5000 PSI
- **MAX TEMP.:** 300°F
- **BRASS INLET:** 3/8" FPT
- **BRASS OUTLET:** 1/4" FPT

\$32.12 SUT2300NW Gun
\$9.96 SUT2300KNW Repair Kit

NON-WEEP



ST-2012 SERIES

SUTTNER

SUTTNER

- Low friction trigger design
- **MAX FLOW:** 10.4 GPM
- **MAX PRESSURE:** 5000 PSI
- **MAX TEMP.:** 300°F
- **INLET:** 3/8" FPT
- **OUTLET:** 1/4" FPT

\$28.84 SUT2012

NON-WEEP



ST-601 SERIES STRAIGHT GUN

SUTTNER

SUTTNER

- 15° angle designed for extended length lances for higher reach!
- **MAX FLOW:** 12.0 GPM
- **MAX PRESSURE:** 4000 PSI
- **MAX TEMP.:** 300°F
- **INLET:** 3/8"
- **OUTLET:** 1/4"

\$30.23 SUT601NW
\$23.72 SUT000054

NON-WEEP



PRESSURE WASH

PRESSURE WASH GUNS



5030 SERIES

J.E. ADAMS



- Brass valve body
- **MAX FLOW:** 12.0 GPM
- **MAX PRESSURE:** 4500 PSI
- **MAX TEMP.:** 300°F
- **INLET:** 3/8" FPT
- **OUTLET:** 1/4" FPT

\$33.19	GU0115	Gun
\$14.54	GU0115K	Repair Kit

NON-WEEP



MV925

MECLINE

- **MAX FLOW:** 8.0 GPM
- **MAX PRESSURE:** 4500 PSI
- **MAX TEMP.:** 320°F
- **INLET:** 3/8" FPT
- **OUTLET:** 1/4" FPT

\$20.88 **MV925**

NON-WEEP



21250 SERIES

GIANT



- Brass/stainless steel discharge fitting
- **MAX FLOW:** 10.0 GPM
- **MAX PRESSURE:** 5000 PSI
- **MAX TEMP.:** 300°F
- **INLET:** 3/8" FPT
- **OUTLET:** 1/4" FPT

\$33.47	PU21250	Stainless Steel
\$26.84	PU21260	Recessed Fitting
\$21.22	PU21290	Plated Steel
\$5.16	PU21227	Repair Kit

NON-WEEP



TRIGGER GUN

CAT PUMPS®



- Nylon body with heat-resistant trigger for longer life, less breakage
- Anti-fatigue design
- Stainless steel ball, seat
- **MAX FLOW:** 10.5 GPM
- **MAX PRESSURE:** 5000 PSI
- **MAX TEMP.:** 300°F
- **INLET:** 3/8" FPT
- **OUTLET:** 1/4" FPT

CALL	PU36140	Gun
	PU36080	Repair Kit

NON-WEEP



SG35 EASY PULL

MTM HYDRO



- **MAX PRESSURE:** 5000 PSI
- **MAX FLOW:** 12.0 GPM
- **INLET:** 3/8"
- **OUTLET:** 1/4"

\$46.45 **MTM100342**

NON-WEEP



MF407 SPRAY GUN

MTM HYDRO



- **MAX PRESSURE:** 4000 PSI
- **MAX FLOW:** 7.0 GPM
- **INLET:** 3/8"
- **OUTLET:** 1/4"

\$36.62 **MTM100001**

NON-WEEP



GUN LANCE COMBINATION

GENERAL PUMP



- **MAX PRESSURE:** 3200 PSI
- **MAX FLOW:** 6.5 GPM
- **MAX TEMP.:** 195°F
- **OUTLET:** M22-F

PRICE	PART #	INLET
\$23.91	GU320038	3/8"
\$26.55	GU3200M	M22-M



SG35 EASY PULL ACID RESISTANT

MTM HYDRO



- **MAX PRESSURE:** 5000 PSI
- **MAX FLOW:** 12.0 GPM
- **INLET:** 3/8"
- **OUTLET:** 1/4"

\$42.54 **MTM100381**

NON-WEEP



M407 SPRAY GUN WITH 36" LANCE

MTM HYDRO



- M407 gun with installed 3/8" male plug and 36" lance with installed 1/4" female quick coupler
- **MAX PRESSURE:** 4000 PSI
- **MAX FLOW:** 7.0 GPM
- **INLET:** 3/8"
- **OUTLET:** 1/4"

\$56.46 **MTM430029**

NON-WEEP

PRESSURE WASH

SURFACE CLEANERS

SURFACE CLEANERS WITH WAND

MOSMATIC



SPECIFICATIONS:

- **MAX. PRESSURE:** 4000 PSI
- **MAX. TEMP:** 250°F
- **INLET PORTS:** 3/8" NPTF

STANDARD FEATURES/ACCESSORIES:

- Two rotor arms with two nozzles
- Includes wand and high-pressure spray gun trigger
- Includes toggle swivel that allows easy switching from horizontal to vertical surfaces
- High RPM stainless steel swivel with self-lubricated ball bearings
- Dual spring carbide seal system for longevity

PRICE	KR #	MFG #	DESCRIPTION
CALL	PWSCM78260	78.260	FL-EG 200 - 8" Model
	PWSCM78262	78.262	FL-EG 300 - 12" Model
	PWSCM78264	78.264	FL-EG 410 - 16" Model

PWSCM78272	78.272	FL-ER 300 - 12" Model
PWSCM78274	78.274	FL-ER 410 - 16" Model

(3) heavy duty 2 1/4" casters

SURFACE CLEANER CONVERSION KIT

MOSMATIC



- Allows users to upgrade key working parts of their surface cleaners; replacing originals with high quality components from Mosmatic.

- **INLET PORT:** 3/8" • **MAX PSI:** 5000 • **MAX TEMPERATURE:** 250° F

INCLUDES:

- 3/8" NPTF inlet
- (1) universal adapter mounting plate with pre-drilled holes
- (3) mounting bolts
- (1) Extension fitting to reduce the distance between nozzles and the ground by 0.87"

PRICE	KR #	MFG #
\$52.30	PWSCM55903	55.903

GUN SWIVEL

MOSMATIC

- 3/8" NPTM x 3/8" NPTF
- Corrosion-resistant materials
- **LENGTH:** 2.75"
- **MAXIMUM PRESSURE:** 4000 PSI
- **MAXIMUM SPEED:** 30 RPM
- **MAXIMUM TEMPERATURE:** 250° F

PRICE	KR #	MFG #
\$30.73	SWM32564	32.564

1/4" SWIVEL

MOSMATIC

- 1/4" NPTM x 1/4" NPTF
- Corrosion-resistant materials
- **LENGTH:** 2.6"
- **MAX PRESSURE:** 4000 PSI
- **MAX SPEED:** 30 RPM
- **MAX TEMP:** 250° F

PRICE	KR #	MFG #
\$32.09	SWM32552	32.552

HIGH FLOW GUN SWIVEL

MOSMATIC

- 3/8" NPTM x 3/8" NPTF
- Stainless steel
- **LENGTH:** 2.75"
- **MAX PRESSURE:** 4000 PSI
- **MAX SPEED:** 30 RPM
- **MAX TEMP:** 250° F

PRICE	KR #	MFG #
\$46.60	SWM32852	32.852

BLACK SHELL HEAT SHIELD

MOSMATIC

- Used with 32.564 DGV 3/8" swivels (listed above)
- Hard plastic shell construction
- Protects from burns and uncomfortable operation while using hot water pressure washer

PRICE	KR #	MFG #
\$10.18	BOMP28973	28.973

PWSCM80770



PWSCM80771

COMMERCIAL SURFACE CLEANERS

MOSMATIC CLEANERS

CALL FOR PRICING



SPECIFICATIONS:

- **MAX TEMP:** 250°F
- **MAX PRESSURE:** 4000 PSI
- **INLET PORTS:** 3/8" NPTF

STANDARD FEATURES/ACCESSORIES:

- Stainless steel body
- High RPM stainless steel swivel with self-lubricated ball bearings
- Includes high-pressure gun

KR #	MFG #	SERIES	DESCRIPTION
PWSCM80770	80.770	FL-CG-520	21" Housing • (2) 1/8" NPTF Rotor Arms • WITHOUT Casters
PWSCM80771	80.771	FL-CR 520	21" Housing • (2) 1/8" NPTF Rotor Arms • WITH 2 1/4" Casters & Mounting Brackets
PWSCM80772	80.772	FL-CR 750	30" Housing • (3) 1/8" NPTF Rotor Arms • WITH 2 1/4" Casters & Mounting Brackets

WHIRL-A-WAY SURFACE CLEANER

BE PRESSURE

SPECIFICATIONS:

- **MAX. FLOW:** 4-8 GPM
- **MAX. PRESSURE:** 4000 PSI
- **MAX. TEMP:** 180°F

STANDARD FEATURES/ACCESSORIES:

- Brush with polypropylene cover
- Rotary arm with (2) 25° nozzles
- Welded steel construction
- 3/8" x 62" hose
- Easy pull gun, handle and grip

PRICE	KR #	MFG #	DESCRIPTION
\$361.25	PWSC16	85.403.003	16" Rotary Arm • 16" Brush
\$373.75	PWSC20Y	85.403.009	20" Rotary Arm • 20" Brush

STAINLESS STEEL SURFACE CLEANER W/WHEELS

BE PRESSURE

SPECIFICATIONS:

- **MAX. FLOW:** 4-8 GPM
- **MAX. PRESSURE:** 4000 PSI
- **MAX. TEMP:** 180°F

STANDARD FEATURES/ACCESSORIES:

- Welded Steel Rotary Spray Bar
- (2x) - 8 GPM & 4,000 PSI
- Nylon Brush Skirt - Keeps user clean
- Replaceable Swivel

PRICE	KR #	MFG #	SIZE
\$623.75	PWSC20	85.403.009	20" Model
\$686.25	PWSC24	85.403.010	24" Model



SURFACE CLEANERS & WATER BROOMS

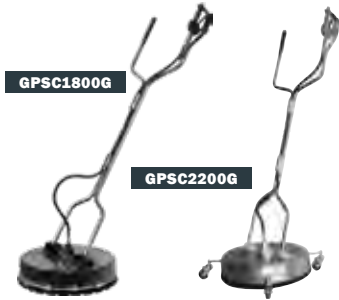

HAMMERHEAD SURFACE CLEANER

GENERAL PUMP

SPECIFICATIONS:

- **FLOW:** 8 GPM
- **MAX. PRESSURE:** 4000 PSI
- **MAX. TEMP:** 180°F
- **INLET:** 3/8" F Snap

STANDARD FEATURES/ACCESSORIES:

- Compensating gun feature
- Greasable zerk
- Rugged ABS cover - resists corrosion
- Heavy-duty anodized aluminum components
- Stiff spray skirt and 2" bristles reduce overspray
- Serviceable swivel

PRICE	KR #	DESCRIPTION
\$394.10	GPSC1800G	18" Housing
\$371.24	GPSC2000G	20" Housing

PRICE	KR #	DESCRIPTION
\$590.26	GPSC2200G	22" Housing
\$453.06	GPSC2400G	24" Housing

12" 3 NOZZLE WATER BROOM WITH 36" LANCE

GENERAL PUMP

- This water broom assembly contains all the parts you need to get a great, easy clean on any smooth, hard surface! It features three nozzles that direct high-pressure streams of water onto the floor, and a 36" molded lance with 1/4" quick connect that makes it easy to connect to your pressure washer of choice. Use up to 3,000 PSI! A high-pressure, quick connect, stainless steel filter is included.

SPECIFICATIONS

- **MAX. PRESSURE:** 3000 PSI
- **INLET PORTS:** 1/4" QC

STANDARD FEATURES/ACCESSORIES:

- 12" long broom with (3) 65° nozzles
- 36" lance with molded rubber grip
- Includes high-pressure filter

\$49.73 **WB100869C**

16" 4 NOZZLE WATER BROOM WITH 36" LANCE

GENERAL PUMP

- This water broom assembly contains all the parts you need to get a great, easy clean on any smooth, hard surface! This 16" bar features three nozzles that direct high-pressure streams of water onto the floor, and a 36" molded lance with 1/4" quick connect that makes it easy to connect to your pressure washer of choice. Use up to 3,000 PSI! A high-pressure, quick connect, stainless steel filter is included.

SPECIFICATIONS

- **MAX. PRESSURE:** 3000 PSI
- **INLET PORTS:** 1/4" QC

STANDARD FEATURES/ACCESSORIES:

- 16" long broom with (4) 65° nozzles
- 36" lance with molded rubber grip
- Includes high-pressure filter

\$75.51 **WB100870C**

TRIKLEENER® DELUXE 12" WATER BROOM WITH QC NOZZLES

GENERAL PUMP

- Perfect for use on paint, concrete, brick, slate, garage floors, wooden decks, docks, truck beds, metal roofing, and more. Great for residential and professional use! Please note that this item only includes the wheeled assembly and nozzles; spray wands must be purchased separately.

SPECIFICATIONS

- **REQUIRED PRESSURE RANGE:** 2700 PSI - 4500 PSI
- **INCLUDES** (3) 65° nozzles
- Steel plug to replace one nozzle for custom spray patterns
- Brass quick connect couplers
- Rubber water shield
- Use with 1/4" quick connect spray wands (excluding Simpson brand)
- Compatible with black soaping low-pressure nozzle, sold separately

- **REQUIRED FLOW RANGE:** 2.3 GPM - 6 GPM
- **ORIFICES:** #1.35 nozzle
- Stainless steel tubing
- 7" adjustable wheels
- For gas pressure washers

\$134.39 **WB2100306**

LANCES & WANDS

TELESCOPING WAND WITH GUN

GENERAL PUMP

SPECIFICATIONS:

- **MAX. PRESSURE:** 4000 PSI
- **MAX. TEMP.:** 195°F
- **BODY MATERIAL:** Fiberglass

PRICE	KR PART #	WAND	CONNECTION	REPLACEMENT GUN	PRICE
\$102.86	GPDLTG12	12'	1/4" quick connect	-	-
\$120.00	GPDLTG18	18'	NPT and M22	GPDCG4000TS18	\$36.71
\$137.14	GPDLTG24	24'	1/4" quick connect	-	-



PRESSURE WASH

LANCES & WANDS



TELESCOPING WANDS

BE PRESSURE



SPECIFICATIONS:

- **PRESSURE:** 2000 - 4000 PSI
- **FLOW:** 8 GPM
- **INLET:** 3/8" M snap coupler
- **OUTLET:** 1/4" F snap coupler

ACCESSORIES/FEATURES:

- Fiberglass construction
- Threaded gun with hose adapters
- Compatible with QC spray tips

\$165.70	PW85206424L	24'	4-Stage
\$134.70	PW85206018L	18'	3-Stage
\$18.92	PW85400019	Support Belt	

FRONT LANCE FOR TELESCOPING WANDS



INCLUDES: M22 & Coupler

\$17.47	PW85791024
----------------	-------------------

CHROME PLATED WANDS

J.E. ADAMS



- Available with or without lance
- Lightweight
- Easy to handle

PRICE	PART #	LENGTH	SIZE
\$2.93	WTZ418	18"	1/4" MPT x 1/8" FPT
\$5.72	WTZ424	24"	1/4" MPT x 1/8" FPT
\$10.42	WTZ436	36"	1/4" MPT x 1/8" FPT
\$2.82	WTZ418MM	18"	1/4" MPT x 1/4" MPT
\$4.96	WTZ424MM	24"	1/4" MPT x 1/4" MPT
\$6.70	WTZ436MM	36"	1/4" MPT x 1/4" MPT

MOLDED GRIP			
PRICE	PART #	LENGTH	SIZE
\$7.30	WTZ418WL	18"	1/4" MPT x 1/8" FPT
\$14.08	WTZ424WL	24"	1/4" MPT x 1/8" FPT
\$19.22	WTZ436WL	36"	1/4" MPT x 1/8" FPT
\$6.08	WTZ418MMWL	18"	1/4" MPT x 1/4" MPT

MOLDED GRIP			
PRICE	PART #	LENGTH	SIZE
\$7.18	WTZ424MMWL	24"	1/4" MPT x 1/4" MPT
\$8.76	WTZ436MMWL	36"	1/4" MPT x 1/4" MPT
\$20.23	WTZ470MM	70"	1/4" MPT x 1/4" MPT

DOUBLE LANCE

GENERAL PUMP



- **MAX FLOW:** 10.5 GPM
- **BRASS OUTLET:** 1/4" NPT-F
- **INLET:** 1/4" NPT-M
- **RATED PSI:** 3650

PRICE	PART #	TYPE	LENGTH	TEMP
\$60.21	GPNDL33	Straight/Zinc	33"	320°F
\$60.21	GPNDL33B	Bent/Zinc	33"	320°F
\$78.56	GPNDL36	Bent/Zinc	36"	284°F
\$93.62	GPNDL72	Bent/zinc	72"	284°F
\$69.90	GPNDL41SS	Straight/Stainless	41"	320°F

SPRAY LANCE WANDS

MOSMATIC



- Nozzle guards included with all Mosmatic wands

PRICE	PART#	LANCE	DESCRIPTION
CALL FOR PRICING	BOMP26703	20" x 8" grip straight	1/4" MNPT x 1/4" FNPT
	BOMP26706	34" x 16" grip straight	1/4" MNPT x 1/4" FNPT
	BOMP26711	41" x 32" grip straight	1/4" MNPT x 1/4" FNPT
	BOMP26980	20" x 8" Grip - Straight	1/4" MNPT x 1/8" FNPT
	BOMP26981	20" x 8" Grip - Bent	1/4" MNPT x 1/8" FNPT
	BOMP26982	41" x 32" Grip - Straight	1/4" MNPT x 1/8" FNPT
	BOMP26983	41" x 32" Grip - Bent	1/4" MNPT x 1/8" FNPT



BOMP26711



BOMP26981

FLOOR MOUNTED WAND HOLDER

MOSMATIC

- Polished stainless steel
- Dimensions:
28.3" L x 3.9" Diameter x 7.9" Base Diameter
- Weep connection: For .6" and 3/8" nozzles
- Solid construction
- 60° angle

\$221.16	BOMP29127
-----------------	------------------



29.010 TIP PROTECTOR

MOSMATIC



\$6.75	BOMP29010	For .6" and 3/8" nozzles
---------------	------------------	--------------------------

PRESSURE WASH

LANCES & WANDS

21735 STAINLESS STEEL LANCE TUBE

GIANT



- **INLET:** 1/4" MNPT • **OUTLET:** 1/4" MNPT • **MAX PRESSURE:** 7,250 PSI
- Please note that this lance does not have a grip, so additional caution should be exercised when working with hot water temperatures.



PRICE	PART#	LENGTH
CALL	PU21735	24"
	PU21736	36"
	PU21737	48"
	PU21738	60"
	PU21739	72"

New!

STAINLESS STEEL LANCE TUBE WITH GRIP

GIANT



- Help you reach new cleaning heights with extended lances. These conduits feature insulated grips for safe and secure handling up to 340°F.
- **INLET:** 1/4" MNPT • **OUTLET:** 1/4" MNPT • **MAX PRESSURE:** 7,250 PSI



\$11.81	PU21742	15.5"
\$11.08	PU21743	24"
\$21.73	PU21744	36"
\$42.81	PU21745	48"
\$33.54	PU21746	60"

New!



New!

18" HOT & COLD WATER LANCE

SUTTNER



- **PRESSURE:** 6000 PSI • **MAX TEMP:** 300°F
- **INLET:** 1/4" MNPT • **OUTLET:** 1/8" FNPT



\$10.96	SUT000260
----------------	-----------

18" CHEMICAL RESISTANT WAND WITH GRIP

SUTTNER



- **PRESSURE:** 6000 PSI • **MAX TEMP:** 300°F
- **INLET:** 1/4" MNPT • **OUTLET:** 1/4" FNPT



\$8.33	SUT000240
---------------	-----------

New!

36" LANCE WAND

KLEEN-RITE LANCES & WANDS



- 1/4" M x 1/4" M



\$6.51	PWLW36
---------------	--------

ALUMINUM EXTENSION LANCE ASSEMBLY WITH QUICK CONNECTS

SUTTNER



- **Max PSI:** 6000 • **Max temp:** 300°F • **Inlet:** 1/4" MPT • **Outlet:** 1/4" MPT
- Nickel chrome plated body with molded plastic grip

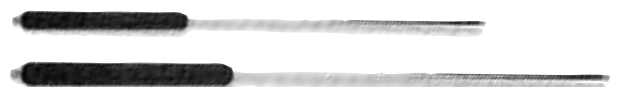

PRICE	PART#	LENGTH	PRICE	PART#	LENGTH
\$9.03	SUT000180	24"	\$22.28	SUT000220	60"
\$12.23	SUT000210	47"	\$24.23	SUT000230	79"

PRESSURE WASH

LANCES & WANDS

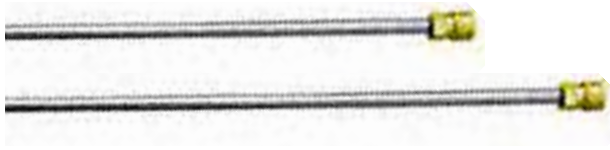

ALUMINUM EXTENSION LANCE ASSEMBLY WITH QUICK CONNECTS

PRESSURE-PRO



- MAX FLOW: 10.5 GPM
- MAX PSI: 4060
- MAX TEMP: 302°F
- INLET: 1/4" M Snap Coupler
- OUTLET: 1/4" F Snap Coupler

PRICE	PART#	LENGTH
\$38.43	PWP072	72"
\$40.76	PWP084	84"

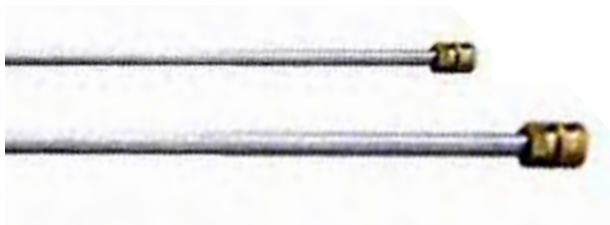

ALUMINUM LANCE ASSEMBLY WITH WAND SAVER

PRESSURE-PRO



- MAX FLOW: 10.5 GPM
- MAX PSI: 4060
- MAX TEMP: 302°F
- INLET: 1/4" M Snap Coupler
- OUTLET: 1/4" F Snap Coupler

PRICE	PART#	LENGTH
\$33.41	PWP048-WS	48"
\$40.65	PWP084-WS	84"

WAND SAVER ATTACHED ON PLUG END

NON-MOLDED SPRAY LANCES



STAINLESS STEEL NON-MOLDED SPRAY LANCE

LANCES & WANDS

- MAX FLOW: 10½ GPM
- SIZE: 1/4" M x M
- MAX PSI: 4100
- MAX TEMP: 300°F

PRICE	PART#	LENGTH
\$14.61	WTS418MM	18"
\$15.80	WTS420MM	20"

PRICE	PART#	LENGTH
\$20.65	WTS424MM	24"
\$31.88	WTS436MM	36"



CHROME PLATED NON-MOLDED SPRAY LANCE

LANCES & WANDS

- MAX FLOW: 10½ GPM
- SIZE: 1/4" M x M
- MAX PSI: 4100
- MAX TEMP: 300°F

PRICE	PART#	LENGTH
\$2.82	WTZ418MM	18"
\$4.96	WTZ424MM	24"

PRICE	PART#	LENGTH
\$6.70	WTZ436MM	36"



GALVANIZED STEEL NON-MOLDED SPRAY LANCE

LANCES & WANDS

- MAX FLOW: 10½ GPM
- SIZE: 1/4" M x M
- MAX PSI: 4100
- MAX TEMP: 300°F

PRICE	PART#	LENGTH
\$5.01	WTG418MM	18"
\$5.57	WTG420MM	20"
\$6.96	WTG424MM	24"

PRICE	PART#	LENGTH
\$8.48	WTG430MM	30"
\$10.04	WTG436MM	36"

New!



LANCE SIDE GRIP

GIANT



- Side grip handle with 1/4" tube holder and built-in set screw. Add extra grip, safety, and maneuverability to your pressure washing lance. Used with Giant 1/4" lance tubes with molded grips.

\$22.02 **PU21704**

PRESSURE WASH

LANCES, WANDS & ACCESSORIES

GUTTER CLEANER ASSEMBLY

GENERAL PUMP



- Requires 1/4" Q.D. socket on wand for complete connection
- Can be attached to standard and telescoping wands so that gutters can be reached from the ground.

\$12.00 GPD20011

QUICK CONNECT GUTTER CLEANER ATTACHMENT

BE PRESSURE



- 8" long
- 1/4" M x F snap coupler ends
- Maximum pressure: 4000 PSI
- Only for use with prosumer gas pressure washer setups
- Attaches to 1/4" quick connector on wands
- Works with BE Pressure 18' and 24' wands, as well as many other brands
- Add on desired spray tip (not included)

\$7.71 PW8540007

M22 GUTTER CLEANER ATTACHMENT FOR SPRAY WANDS

BE PRESSURE



- Works with many 1/4" quick connect spray tips
- Maximum flow: 4 GPM
- Will not work with consumer grade electric pressure washers
- Compatible with prosumer-level gas pressure washers
- For professional use
- Maximum pressure: 4000 PSI
- M22 x 1/4" sockets

\$9.46 PW85400033

JETTER GENIE PRESSURE WASH SEWER JETTER CONVERSION KIT

MTM HYDRO ACCESSORIES



SPECIFICATIONS:

- **MAX PRESSURE:** 4000 PSI
- **FLOW:** 4.5 GPM

STANDARD FEATURES/ACCESSORIES:

- For use with gas-powered pressure washers only
- Will not connect to consumer-grade electric units
- Great for residential consumers seeking professional results
- Includes 3/8" male quick connect adapter
- Includes M22 metric threaded male to 3/8" male NPT adapter
- Works with M22F & 3/8" female quick connect hoses
- For use only with pipes and drains that are in good, sturdy condition

\$135.88 MTM435001 Kit with 50' Hose
\$233.13 MTM435002 Kit with 100' Hose



BRUSHES & BROOMS

BLUE CLEAN BRUSH KIT WITH ADAPTERS

AR NORTH AMERICA



- Rotary brush features water pressure-driven rotating bristles that dislodge dirt and grime, and is perfect for vehicles including cars, trucks, buses, RVs, and more. Fixed utility brush is safe for most surfaces, including household surfaces such as patio furniture.

SPECIFICATIONS:

- **PRESSURE:** 2000 PSI

INCLUDES:

- 5 adapters and 2 brushes

\$27.96 AR909102K

7" NYLON BRISTLE ROTATING BRUSH ACCESSORY

SUTTNER



- **PRESSURE:** 725 PSI
- **INLET:** 1/4" MNPT
- **MAX TEMP.:** 122°F
- **ORIFICE:** 2.8
- **FLOW RATE:** 8 GPM

PRICE	PART #	DESCRIPTION
\$56.73	SUT21121	Adjustable - Nylon 180° adjustability for vertical and horizontal surfaces
\$125.15	SUT20050	Non-Adjustable - Nylon
\$48.16	SUT20020	Natural Fiber



SUT21121

SUT20050

SUT20020

PRESSURE WASH

SPRAY NOZZLES

**FIND YOUR
SPRAY TIP
NUMBER HERE!**



Spraying Systems Co.®

WASHJET® MEG SPRAY NOZZLES SPRAYING SYSTEMS CO.

- Spray angles of 0° to 65°
- Uniform distribution - an internal guide vane stabilizes liquid turbulence
- Longer wear life and flow control accuracy with specially hardened stainless steel
- Female nozzles and VeeJet® nozzles are available

\$4.54	1/4"
\$4.33	1/8"

HOW TO DETERMINE NOZZLE SIZE:

- Calculate GPM & PSI to determine nozzle size
(Ex. 1200 PSI at 3.8 GPM = nozzle size of 07 See * above)
- After determining nozzle size, choose a degree of spray pattern:
 - 15 = 15° (narrow)
 - 25 = 25° (medium)
 - 40 = 40° (wide)
- Available spray patterns : 05, 15, 25, 40, 50, 65, 80
- Degree of spray does not affect nozzle volume

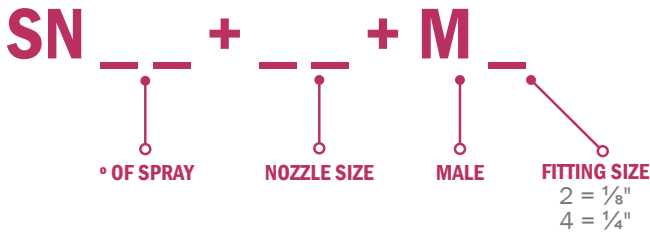

INTERIOR #S ARE GPM

NOZZLE SIZE	ORIFICE DIAM. (INCHES)	40 PSI	100 PSI	250 PSI	500 PSI	600 PSI	700 PSI	800 PSI	1000 PSI	1200 PSI *	1500 PSI	2000 PSI	2500 PSI	3000 PSI	3500 PSI	4000 PSI
2	.034	.20	.32	.50	.71	.77	.80	.89	1.0	1.1	1.2	1.4	1.6	1.7	1.9	2.0
4	.052	.40	.63	1.00	1.40	1.60	1.70	1.80	2.0	2.2	2.4	2.8	3.2	3.5	3.8	4.0
4.5	.055	.45	.71	1.10	1.60	1.70	1.90	2.00	2.3	2.4	2.8	3.2	3.6	3.9	4.3	4.5
5	.057	.50	.79	1.30	1.80	1.90	2.10	2.20	2.5	2.8	3.1	3.5	4.0	4.3	4.7	5.0
5.5	.060	.55	.87	1.40	1.90	2.10	2.30	2.50	2.8	3.0	3.4	3.9	4.3	4.8	5.2	5.5
6	.062	.60	.95	1.50	2.10	2.30	2.50	2.70	3.0	3.2	3.7	4.2	4.7	5.2	5.6	6.0



WASHJET® IMEG® SPRAY NOZZLES SPRAYING SYSTEMS CO.



Spraying Systems Co.®

- Patented design provides optimized fluid dynamics to minimize turbulence and maximize spray performance
- The 302 stainless steel guide vane further stabilizes turbulent flow and improves pattern quality and cleaning efficiency
- Spray angles of 0° to 65°
- Uniform distribution - an internal guide vane stabilizes liquid turbulence
- Longer wear life and flow control accuracy with specially hardened stainless steel

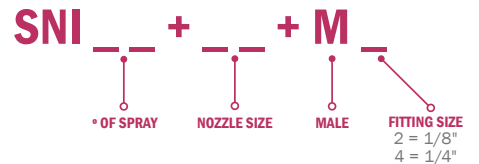

JROD 4 WAY 1/4" NOZZLE HOLDER ACCESSORIES

STANDARD FEATURES/ACCESSORIES:

- Simple, handy tool allows you to quickly switch between four different nozzles on one spray gun wand
- Accepts ANY 1/4" MPT spray nozzle
- Keeps your nozzles in one place - avoid wet pockets and lost nozzles!

\$32.08 JROD

PRESSURE WASH

QUICK DISCONNECT



FEMALE SOCKET



FEMALE PLUG



MALE SOCKET



MALE PLUG

QUICK DISCONNECT - FOR USE IN PRESSURE WASHERS POWER WASH SOCKETS & PLUGS

\$4.13	HF0350	1/4" Female Socket	Brass
\$4.13	HF0351	1/4" Male Socket	Brass
\$2.38	HF0352	1/4" Male Plug	Zinc Coated Steel
\$2.38	HF0353	1/4" Female Plug	Steel
\$0.51	HF0356	1/4" O-Ring	-
\$6.61	HF0360	1/4" Female Socket	Stainless Steel
\$6.61	HF0361	1/4" Male Socket	Stainless Steel
\$3.07	HF0362	1/4" Female Plug	Stainless Steel
\$3.07	HF0363	1/4" Male Plug	Stainless Steel
\$2.12	HF0370	3/8" Female Plug	Steel
\$2.12	HF0371	3/8" Male Plug	Zinc Coated Steel
\$5.17	HF0372	3/8" Male Socket	Brass
\$5.17	HF0373	3/8" Female Socket	Brass

\$0.54	HF0374	3/8" O-Ring	-
\$8.91	HF0375	3/8" Female Socket	Stainless Steel
\$8.91	HF0376	3/8" Male Socket	Stainless Steel
\$3.93	HF0377	3/8" Female Plug	Stainless Steel
\$3.93	HF0378	3/8" Male Plug	Stainless Steel
\$8.57	HF0380	1/4" F 2-way shut-off plug	Brass
\$13.85	HF0381	1/4" F 2-way shut-off socket	Brass
\$6.69	HF0391	1/2" Female Plug	Steel
\$13.96	HF0394	1/2" Female Socket	Brass
\$16.64	HF0395	1/2" Male plug	Stainless Steel
\$54.07	HF0397	1/2" Female Socket	Stainless Steel
\$24.34	HF0398	1/2" Female Plug	Stainless Steel

KARCHER TYPE FITTINGS



HF0400



HF0401



HF0403



HF0402

KARCHER TYPE FITTINGS SUTTNER



\$3.95	HF0400	1/4" F x 1/4" M Brass Plug
\$3.95	HF0401	3/8" F x 3/8" M Brass Plug
\$6.74	HF0407	ST-40 Screw Coupling 3/8" Viton 5800 PSI
\$5.59	HF0404	ST-40 Screw Coupling 1/4" Viton 5800 PSI
\$5.59	HF0402	1/4" F x 1/4" F Brass Plug
\$6.74	HF0403	3/8" F x 3/8" F Steel Coupler

QUICK CONNECT TIPS



QUICK CONNECT CHEMICAL TIP SUTTNER



- #40 orifice • 65° nozzle

\$4.09 **QC65CT**



QUICK CONNECT SPRAY TIP KIT SUTTNER



KIT INCLUDES:

- (1) 400000D45 SZ 4 1/2 - Red
- (1) 400001545 SZ 4 1/2 - Yellow
- (1) 400002545 SZ 4 1/2 - Green
- (1) 400004045 SZ 4 1/2 - White
- (1) 4000S6540 SZ 4 - Black

\$14.87 **KRK3000**

QUICK CONNECT/DISCONNECT ACCESSORIES & NOZZLES



3/8" QUICK CONNECT COUPLER WITH M22 MALE END GENERAL PUMP



- Prosumer-grade, high-performance, high-pressure hose adapter to allow for quick connections. Please note that coupler requires a male quick-connect plug. Reliable and durable construction ensures longevity even over prolonged usage.
- 3/8" Snap Coupler Female Inlet / 22m Threaded Male Outlet
- Pressure Rating: 4000 PSI

\$7.06 **GPP10035**



M22 x 3/8" QUICK CONNECT COUPLER GENERAL PUMP



- Ideal for connecting pressure washers or guns to a hose
- M22 Female inlet x 3/8" QC outlet
- Pressure Rating: 4000 PSI
- Used with DT10088 to convert Karcher gas units

\$6.67 **GPP10037**



NOZZLE 5 PACKS GENERAL PUMP



\$19.00	GPP105082	3.0 ORIFICE NOZZLES (1) 0° red, (1) 15° yellow, (1) 25° green, (1) 40° white, (1) 65° black chemical/low-pressure soap applicator
\$19.00	GPP105083	3.5 ORIFICE NOZZLES (1) 0° red, (1) 15° yellow, (1) 25° green, (1) 40° white, (1) 65° black chemical/low-pressure soap applicator
\$19.00	GPP105084	4.0 ORIFICE NOZZLES (1) 0° red, (1) 15° yellow, (1) 25° green, (1) 40° white, (1) 65° black chemical/low-pressure soap applicator
\$19.00	GPP105086	5.0 ORIFICE NOZZLES (1) 0° red, (1) 15° yellow, (1) 25° green, (1) 40° white, (1) 65° black chemical/low-pressure soap applicator

PRESSURE WASH

NOZZLES

QUICK CONNECT HIGH-PRESSURE SPRAY TIPS

POWER WASH SPRAY TIPS

- 1/4"
- 5000 PSI operating pressure
- Through-hardened stainless steel orifices

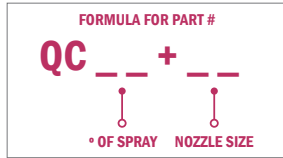

RED - 0°

QUICK CONNECT HIGH PRESSURE SPRAY TIPS

PRICE	PART #	NOZZLE SIZE
\$4.09	QC0003	3
	QC00035	3.5
	QC0004	4
	QC00045	4.5
	QC0005	5
	QC00055	5.5
	QC0006	6
	QC0065	6.5
	QC0007	7
	QC0008	8
QC0009	9	

YELLOW - 15°

QUICK CONNECT HIGH PRESSURE SPRAY TIPS

PRICE	PART #	NOZZLE SIZE
\$4.09	QC1502	2
	QC15025	2.5
	QC1503	3
	QC15035	3.5
	QC1504	4
	QC15045	4.5
	QC1505	5
	QC15055	5.5
	QC1506	6
	QC1507	7
	QC1508	8
	QC1510	10

GREEN - 25°

QUICK CONNECT HIGH PRESSURE SPRAY TIPS

PRICE	PART #	NOZZLE SIZE
\$4.09	QC2502	2
	QC25025	2.5
	QC2503	3
	QC25035	3.5
	QC2504	4
	QC25045	4.5
	QC2505	5
	QC25055	5.5
	QC2506	6
	QC25065	6.5
	QC2507	7
	QC2508	8
	QC25085	8.5
	QC2509	9
	QC2510	10

WHITE - 40°

QUICK CONNECT HIGH PRESSURE SPRAY TIPS

PRICE	PART #	NOZZLE SIZE
\$4.09	QC4002	2
	QC4003	3
	QC40035	3.5
	QC4004	4
	QC40045	4.5
	QC4005	5
	QC40055	5.5
	QC4006	6
	QC40065	6.5
	QC4007	7
	QC40075	7.5
	QC4008	8
	QC40085	8.5
QC4010	10	
QC4090	9	



QUICK CONNECT 1/4" NOZZLE HOLDER
SUTTNER

\$3.08 SUT2515

KEEP YOUR NOZZLES ORGANIZED AND EASY TO REACH WITH THE NEW QUICK CONNECT NOZZLE HOLDER FROM SUTTNER!

FOOT VALVES/STRAINERS/CHECK VALVES



BLUE FOOT VALVE

FOOT VALVES

- For All HydroMinder Models: 506, 511, 5111, 515, 561, 562, 525, & 530
- Blue, VITON for use with whitewalls, butyl and alkali
- Corrosion-resistant plastic and rubber last longer
- Step-down hose barb 1/4"-3/8"-1/2"

\$13.12 IN250020 Single
\$125.37 IN250020-10 10 Pack



GRAY FOOT VALVE

FOOT VALVES

- For Soap & Wax (EPDM Seal)
- Polypropylene and have 1/4", 3/8" and 1/2" barbs
- Hydrominder replacement part

\$9.62 IN250100 Single
\$91.85 IN250100-10 10 Pack



FOOT CHECK VALVE

FOOT VALVES

- 1/4" Brass • 40 mesh

\$4.62 INFBS4



FOOT VALVE STRAINER

FOOT VALVES

- 1/4" 60 Mesh

\$7.46 INHB500



STAINLESS STEEL STRAINER

DEMA FOOT VALVES

\$5.57 INDP10011 1/4"
\$7.21 INDP3610 3/8"



1/2" PVC BARBED CHECK VALVE

FOOT VALVES

- With Stainless Steel Strainer

\$6.49 CV0067 Check Valve
\$3.99 IN010 Strainer



1/2" PVC BARBED INLINE CHECK VALVE

FOOT VALVES

- Viton

\$11.58 IN10076303



1/2" PVC BARBED INLINE CHECK VALVE

FOOT VALVES

- EPDM

\$8.82 IN10076304



Want to receive information on exclusive deals?

SIGN UP FOR OUR MONTHLY EMAIL LIST!!!

PRESSURE WASH

ADJUSTABLE & ADJUSTABLE ROTATING NOZZLES

DS TWIST ADJUSTABLE DOWNSTREAM SOFT WASH NOZZLES

X-JET



ACCESSORIES/FEATURES

- Soft wash low-pressure adjustable nozzle
- Nozzles twist to adjust spray pattern
- Spray patterns between 0° and 60°
- Works with high-pressure hose up to 100' long

PRICE	KR #	GPM	REACH
\$65.25	TWIST23	2 - 3	40 Ft.
\$65.25	TWIST37	3 - 7	50 Ft.
\$65.25	TWIST712	7 - 12	60 Ft.

YHL ADJUSTABLE NOZZLES

GENERAL PUMP



SPECIFICATIONS:

- RATED PSI: 3650
- MAX. PSI 4050
- INLET: 1/4" BSP-F
- MAX TEMP: 195°F

STANDARD FEATURES/ACCESSORIES:

- Adjustable spray nozzle with variable spray angle and high or low-pressure settings

PRICE	KR #	NOZZLE	COLOR
\$15.85	GPNYHL20	2	Light Green
\$15.85	GPNYHL25	2.5	Pink
\$15.85	GPNYHL30	3	White
\$15.85	GPNYHL35	3.5	Brown
\$15.85	GPNYHL40	4	Dark Yellow
\$15.85	GPNYHL45	4.5	Blue

PRICE	KR #	NOZZLE	COLOR
\$15.85	GPNYHL50	5	Light Purple
\$15.85	GPNYHL55	5.5	Dark Red
\$15.86	GPNYHL60	6	Dark Green
\$15.85	GPNYHL70	7	Orange
\$15.85	GPNYHL80	8	Silver

YR36K ROTATING NOZZLE

GENERAL PUMP



GPNYR36K60

SPECIFICATIONS:

- MAX. PSI: 3650
- INLET: 1/4" BSP-F
- MAX TEMP: 212°F

STANDARD FEATURES/ACCESSORIES:

- Boasts durable brass construction with a shock-resistant ceramic seat and nozzle - Operates in any direction
- For common market pressures

PRICE	KR #	NOZZLE	COLOR
\$45.15	GPNYR36K30	3	Blue/White
\$31.25	GPNYR36K35	3.5	Blue/Brown
\$45.15	GPNYR36K40	4	Blue/Yellow
\$45.15	GPNYR36K45	4.5	Blue/Blue
\$45.15	GPNYR36K50	5	Blue/Purple

PRICE	KR #	NOZZLE	COLOR
\$45.15	GPNYR36K60	6	Blue/Green
\$45.15	GPNYR36K65	6.5	Blue/Lt. Blue
\$45.15	GPNYR36K70	7	Blue/Orange
\$45.15	GPNYR36K80	8	Blue/Silver

ZROTOMAX ADJUSTABLE ROTATING NOZZLE

GENERAL PUMP



GPNROTOMAX-1

SPECIFICATIONS:

- RATED PSI: 3500 PSI
- INLET: 1/4"-19 BSPP-F
- MAX TEMP: 176°F
- FLOW RANGE: VARIES

PRICE	KR #	FLOW RANGE	COLOR I.D.
\$65.68	GPNROTOMAX-1	2.1 - 2.6 GPM	Black/Red
\$65.68	GPNROTOMAX-2	2.9 - 4.0 GPM	Black/Light Blue
\$65.68	GPNROTOMAX-3	4.2 - 5.5 GPM	Black/Black

ADJUSTABLE NOZZLE

SUTTNER NOZZLES



- INLET: 1/4"
- MAX PSI: 3600 PSI
- MAX FLOW: 8 GPM

- OUTLET: 1/4"
- MAX TEMP: 300°F

\$18.73 SUT51N

ROLLOVER NOZZLE

SUTTNER NOZZLES



- INLET: 1/4"
- MAX PSI: 3600 PSI

- OUTLET: 1/4"
- MAX TEMP: 300°F

\$22.07 SUT56

PRESSURE WASH

TURBO NOZZLES



PU22040-45

PU22060-45

TURBO NOZZLE

GIANT NOZZLES



- FOR A COMPLETE LISTING PLEASE SEE BAY ACCESSORIES
- 0° high-pressure impact
- Specify nozzle size: 2.0 - 20.0
- 20° angle spray coverage
- INLET: 1/4" BSP
- MAX TEMP: 195°

PRICE	PART #	PSI
\$55.83	PU22040-45	3600
\$88.81	PU22060-45	5800

New!



TURBO FILTER

GIANT NOZZLES



- Helps to protect the high-pressure pumps and turbo nozzles from fluid contamination
- 2" in length
- INLET: 1/4" FNPT
- 50 micron mesh
- OUTLET: 1/4" MNPT

\$12.19 PU22175

New!



22175-BSP BRASS TURBO FILTER

GIANT NOZZLES



- It boasts a 50 micron mesh screen and measures 2" long.
- INLET: 1/4" FBSP
- OUTLET: 1/4" MNPT

\$12.09 PU22175-BSP

New!



STAINLESS STEEL TURBO NOZZLE FILTER

GIANT NOZZLES



- Constructed of 50 mesh stainless steel
- PSI: Up to 5000
- 1/4" NPT x 1/4" FNPT

\$16.53 PU22175-4000

New!



23900-055 TURBO LASER ROTOR NOZZLE

GIANT NOZZLES



- Get the intense cleaning power of a rotating 20° spray angle
- PSI: 4500
- INLET: 1/4" FBSP

\$83.48 PU23900-5.5

ST-357 TURBO NOZZLES

SUTTNER



SPECIFICATIONS:

- MAX. PRESSURE: 3625 PSI
- CONNECTION: 1/4" FPT
- MAX TEMP: 190°F

STANDARD FEATURES/ACCESSORIES:

- 0° rotation creates a cleaning and tearing action ideal for hard surface applications
- Improved materials for longer life



PRICE	KR #	NOZZLE	COLOR
\$59.93	SUT357-3	3	White
\$59.93	SUT357-3.5	3.5	
\$59.93	SUT357-4	4	
\$59.93	SUT357-4.5	4.5	
\$59.93	SUT357-5	5	

PRICE	KR #	NOZZLE	COLOR
\$59.93	SUT357-5.5	5.5	White
\$59.93	SUT357-6	6	
\$59.93	SUT357-8	8	
\$65.18	SUT357-9	9	
\$65.18	SUT357-10	10	

AL-TPR25 1/4" HEAVY DUTY ROTATING NOZZLE

AR NORTH AMERICA



SPECIFICATIONS:

- MAX. PRESSURE: 3675 PSI
- SPRAY ANGLE: 15°

- INLET: 1/4"
- MAX. TEMP.: 195°F

STANDARD FEATURES/ACCESSORIES:

- Rotating action moves high-pressure water in a circle



ARTPR2570

PRICE	KR #	ORIFICE	NOZZLE	COLOR ID
\$47.12	ARTPR2530	1.3 mm	4	Dark Green
\$47.12	ARTPR2550	1.5 mm	6	Violet
\$47.12	ARTPR2570	1.7 mm	7	Gray



NOZZLES AND FILTERS



BRASS STEAM NOZZLE GENERAL PUMP

- SPECIFICATIONS:**
- **INLET:** 1/4"
 - **MAX PRESSURE:** 1450 PSI

\$17.26 G PSTN14F



DRAIN CLEANING NOZZLES GENERAL PUMP

- Self-propelled drain cleaning nozzle lets you unclog drain lines inexpensively. Hook up to high-pressure hose to blast through clogs.

\$16.40	GPNYDRNT1	1/4" Male Brass Nozzle
\$24.82	GPNYDRNT2	1/4" Male Stainless Steel Nozzle
\$33.73	GPNYDRNT3	3/8" Male Stainless Steel Nozzle



INLET FILTER GENERAL PUMP

- SPECIFICATIONS:**
- **MAX FLOW:** 5.8 GPM
 - **MAX PRESSURE:** 145 PSI
 - **INLET:** 1/2" F
 - **OUTLET:** 1/2" M
 - **BYPASS:** 2 x 1/4" BSP-F
 - **SCREEN:** 50 Mesh
 - Integrated garden hose nut

\$16.76 GPPZMFIL



LOW-PRESSURE IN-LINE FILTER WITH BRASS GARDEN HOSE FITTING GENERAL PUMP

- SPECIFICATIONS:**
- **MAX FLOW:** 8 GPM
 - **MAX PRESSURE:** 145 PSI
 - **INLET:** 1/2" NPT-F
 - **OUTLET:** 1/2" NPT-M
 - **ACCESSORY:** 2 x 1/4" G
 - **SCREEN:** 50 Mesh
 - Die-cast aluminum (anodized) housing & plastic cap

\$11.64 GPP2100472GH



CHEMICAL FILTERS GENERAL PUMP

- Plastic Two-Step chemical filter WITHOUT check valve, black

\$1.03 GPD40006



CHEMICAL FILTERS GENERAL PUMP

- Plastic chemical filter WITH check valve, gray

\$1.50 GPD40003



INLET FILTERS GENERAL PUMP

- SPECIFICATIONS:**
- **MAX FLOW:** 8 GPM
 - **MAX PRESSURE:** 150 PSI
 - **INLET:** 3/4" Garden Hose
 - Integrated garden hose nut

\$18.52 GPP100649 1/2" NPT-M Inlet
\$18.52 GPP100650 3/8" NPT-M Inlet



INLET FILTERS WITH BYPASS PORT GENERAL PUMP

- SPECIFICATIONS:**
- **MAX FLOW:** 8 GPM
 - **MAX. PRESSURE:** 150 PSI
 - **BYPASS PORT:** 1/4"
 - **INLET:** 3/4" Garden Hose
 - Integrated garden hose nut

\$18.52 GPP100651 1/2" NPT-M Inlet
\$16.54 GPP100652 3/8" NPT-M Inlet



GPP100560

GPP100622

INLINE HIGH-PRESSURE FILTERS GENERAL PUMP

- SPECIFICATIONS:**
- **MAX FLOW:** 8 GPM
 - **MAX PSI:** 5500 PSI
 - **MAX TEMP:** 200°F
 - **SCREEN:** 100 Mesh

\$12.94	GPP100560	Stainless Steel (1/4" OD Plug x 1/4" NPTM)
\$10.36	GPP100622	Brass (1/4" M x M)
\$10.36	GPP100647	Brass (1/4" M x F)

CLEAR BOWL STRAINERS GENERAL PUMP

- **MAX PRESSURE @ 70°F:** 150 PSI
- **MAX PRESSURE @ 125°F:** 125 PSI
- **O-RING MATERIAL:** EPDM
- **BODY MATERIAL:** Nylon
- **BOWL MATERIAL:** Polycarbonate
- **SCREEN:** Stainless steel 50 mesh

PRICE	PART #	INLET/OUTLET	PRICE	PART #	INLET/OUTLET
\$7.87	GPDF05050	1/2"	\$23.42	GPDF12550	1/4"
\$8.49	GPDF07550	3/4"	\$25.30	GPDF15050	1/2"
\$20.54	GPDF10050	1"			



PRESSURE WASH



HOSE REELS

STEEL A-FRAME HOSE REEL

GENERAL PUMP



GPP2103410

- Holds 3/8" high-pressure hose
- Professional grade, sturdy & reliable
- **PRESSURE RATING:** 5000 PSI
- **MAXIMUM TEMPERATURE:** 300°F

\$239.99	GPD50150	Holds 150'
\$249.99	GPD50300	Holds 300'
\$259.99	GPD50450	Holds 450'
\$301.37	GPP2103410	12V Hose Reel Motor Kit
\$337.06	GPDMC12V	12V Variable Speed Rewind Kit

HOSE REELS

GENERAL PUMP



- Comes complete with mounting base
- Full flow swivel brass joint
 - Solid center core for maximum strength
 - Resists rust and corrosion
 - **PRESSURE RATING:** 4000 PSI
 - **INLET PORT:** 3/8" NPT-F
 - **OUTLET PORT:** 3/8" NPT-F

\$85.44	GPD30001	50' x 3/8"
\$98.33	GPD30002	100' x 3/8"
\$119.55	GPD30004	150' x 3/8"
\$135.31	GPD30006	200' x 3/8"

TRAILER MOUNT HOSE REEL

GENERAL PUMP



- Holds up to 200 feet of 3/8" hose
- **SWIVEL PRESSURE RATING:** 5000 PSI
- **MAXIMUM TEMPERATURE:** 250°F
- **INLET PORT:** 1/2" NPT-F
- **OUTLET PORT:** 1/2" NPT-F
- Optional mounting bracket available

\$349.69	GPD50200-TM	Reel. Up to 200' of 3/8" hose
\$350.18	GPDHRTM50100	Reel. Up to 100' of 3/8" hose
\$25.69	GPDHRUM	Mounting Bracket
\$66.12	DHRFM	For flat mounting to a trailer or horizontal base

STACKING KIT FOR DHRA HOSE REELS

GENERAL PUMP

HOSE REELS NOT INCLUDED



- Holds up to 200 feet of 3/8" hose
- Fits DHRA hose reels
- Stack up to 4 reels high
- Stainless steel hardware

\$52.73	GPP2100437	Powder coated steel
\$152.70	GPP2100437SS	Stainless Steel

New!

HOSE REEL CART

GENERAL PUMP



- Fits GP hose reels **EXCEPT A-FRAME MODELS**
- Flat-free tires, removable handle, on-board quick connect spray nozzle storage

\$90.62	GPP2100375
----------------	-------------------

HOSE REEL WITH MOUNTING BASE

GENERAL PUMP



- Holds 3/8" high-pressure hose
- "Posi-Pin" lock prevents unwanted de-reeling
- Rolled, beaded edge flanges prevent punctures
- Solid center core for maximum strength
- **PRESSURE RATING:** 5000 PSI

\$170.62	GPD50100	Holds 100'
\$118.99	GPDHR50150	Holds 150'

WALL MOUNT HOSE REEL

GENERAL PUMP



- Holds up to 200 feet of 3/8" hose
- **SWIVEL PRESSURE RATING:** 4000 PSI
- **MAXIMUM TEMPERATURE:** 185°F
- **INLET PORT:** 1/2" NPT-F
- **OUTLET PORT:** 3/8" NPT-F
- Wall mount using kit 2100531 - **NOT INCLUDED**

\$180.56	GPD50200-WM	Reel
\$29.64	GPP2100531	Mounting Kit

STAINLESS STEEL HOSE REEL

GENERAL PUMP



- Holds 3/8" high-pressure hose
- **MAX PRESSURE:** 5000 PSI
- **MAX TEMP:** 250 degrees F
- **INLET:** 1/2" NPT-Female
- **OUTLET:** 1/2" NPT-Female
- **PRESSURE RATING:** 5000 PSI

\$512.35	GPD50150SS	Holds 150'
\$487.65	GPD50300SS	Holds 300'
\$549.38	GPD50450SS	Holds 450'

HOSE REEL SWIVEL WALL MOUNT

GENERAL PUMP



- Center mounting holes - attaches directly to wall stud. Four outside mounting holes anchor to wall, trailer or ceiling

\$54.12	GPP2100379
----------------	-------------------

MOUNTING HARDWARE NOT INCLUDED

CART FOR DHRA A-FRAME REELS

GENERAL PUMP



- Fits DHRA A-Frame reels
- Steel hardware, powder-coated finish
- Rugged, flat-free tires

\$161.13	GPD2100465
-----------------	-------------------

HOSE REELS NOT INCLUDED

PRESSURE WASH

HOSE REELS

HOSE REEL MTM HYDRO



- Features a direct hand crank with locking mechanism and full flow brass swivel joint
- Recommended for cold water use only
- Holds up to 200 feet of 3/8" hose
- 4 1/4" x 6" mounting plate
- Steel frame
- Prosumer grade
- **MAXIMUM PRESSURE:** 4000 PSI

\$145.08 MTM270007



STAINLESS STEEL HOSE REEL WITH NICKEL PLATED SWIVEL STEEL EAGLE



FEATURES:

- 304 stainless steel
- Easy-turn handle
- Pre-drilled mounting holes
- Friction brake - no hose backlash
- Heavy duty nickel plated Super Swivel*
- All stainless steel fasteners

SPECIFICATIONS:

- 1/2" plumbing
- Max. Temp: 325° F
- Rated to 3000 PSI

*** MAY BE SUSCEPTIBLE TO CORROSION**

\$518.29	KSE-1001-SW	12" Drum Holds 200' of 1/2" Hose
\$579.27	KSE-1000-SW	18" Drum Holds 325' of 1/2" Hose

A FRAME HOSE REELS

STEEL EAGLE



SPECIFICATIONS:

- 1/2" plumbing
- Stainless steel construction
- 325° Fahrenheit maximum temperature
- Stainless steel options rated to 4000 PSI
- Nickel Plated options rated 3000 PSI

FEATURES:

- Nyrim frame
- Friction brake
- Lock pin

PRICE	PART #	DESCRIPTION	SWIVEL
\$480.77	K01-0106-1-SS	12" Drum Holds 200' of 1/2" hose or 300' of 3/8" Hose	Stainless Steel Super Swivel
\$518.29	K01-0107-1-SS	18" Drum Holds 325' of 1/2" hose or 450' of 3/8" Hose	Stainless Steel Super Swivel
\$457.32	K01-0106-1-SW	12" Drum Holds 200' of 1/2" hose or 300' of 3/8" Hose	Nickel Plated Super Swivel*
\$487.80	K01-0107-1-SW	18" Drum Holds 325' of 1/2" hose or 450' of 3/8" Hose	Nickel Plated Super Swivel*

*** NICKEL PLATED SWIVELS MAY BE SUSCEPTIBLE TO CORROSION**

STAINLESS STEEL HOSE REEL (HAND CRANK OR ELECTRIC)

STEEL EAGLE



ELECTRIC

HAND CRANK

SPECIFICATIONS:

- 1/2" plumbing
- 304 stainless steel construction
- 325° Fahrenheit maximum temperature
- Rated to 4000 PSI

FEATURES:

- 304 stainless steel frame and center hub
- Friction brake - no hose backlash
- Heavy duty nickel plated Super Swivel*
- Lock pin
- Stainless steel plumbing resists corrosion

\$1,097.56	S18-12H	12" Drum Holds up to 200' of 1/2" Hose	Hand Crank
\$1,310.98	S18-18H	18" Drum Holds up to 325' of 1/2" Hose	Hand Crank
\$1,585.37	S18-12E	12" Drum Holds up to 200' of 1/2" Hose	Electric
\$1,707.32	S18-18E	18" Drum Holds up to 325' of 1/2" Hose	Electric

*** MAY BE SUSCEPTIBLE TO CORROSION**

12 GAUGE A FRAME STEEL HOSE REELS (HAND CRANK OR ELECTRIC)

COXREELS



HAND CRANK

ELECTRIC

- "A" frame base constructed with heavy duty 12-gauge steel that is welded all as one piece. Disks are designed with rolled edges and have been ribbed to provide higher durability, strength and protection to both the hose and operator. Incorporates an electroless nickel plated steel 90° inlet swivel with NPT threading. Pillow block bearings are permanently lubricated and feature a self-aligning design delivering smooth rotation.

SPECIFICATIONS:

- I.D: 1/2"
- O.D: 7/8"
- Max PSI: 3,000

FEATURES:

- 12-gauge steel CNC robotically welded "A" frame base
- CNC robotically spun ribbed disks with rolled edges
- Self-aligning permanently lubricated bearings
- CPC powder coat finish hinders rust and resists chipping
- Low profile outlet riser with open drum slot
- 90° electroless nickel plated steel NPT threaded swivel
- Locking pin prevent reel rotation when not in use
- Steel hand crank with a smooth round handle

\$360.79	1125-4-200	12" Drum Holds up to 200' of Hose	Hand Crank
\$1,022.64	1125-4-200-E	12" Drum Holds up to 200' of Hose	Electric
\$1,029.83	1125-4-325-E	12" Drum Holds up to 325' of Hose	Electric

PRESSURE WASH

1/4" HOSE



1/4" HOSE ASSEMBLIES

KLEEN-RITE

KLEEN-RITE CORP.
YOUR RELIABLE SUPPLIER FOR THE CAR WASH INDUSTRY

- **MAX PSI:** 3000
- **MAX TEMP:** 250°F
- **FITTINGS:** 1/4"
- Made with Continental brand hose | Single wire braid construction
- Hose guard options available - call for details

PRICE	PART#	LENGTH	COLOR
\$45.23	HA254WBK0101	25'	Black
\$39.78	HA254WBL0101	25'	Blue
\$85.48	HA504WBK0101	50'	Black
\$74.72	HA504WBL0101	50'	Blue

PRICE	PART#	LENGTH	COLOR
\$167.12	HA1004WBK0101	100'	Black
\$145.61	HA1004WBL0101	100'	Blue
\$148.12	HA1004WBL0102*	100'	Blue
WITH SWIVEL ENDS			
\$216.49	HA1504WBL0101	150'	Blue

25' - 1/4" PACKAGED HIGH-PRESSURE HOSE

BE PRESSURE



- **COVER:** Single Wire Braid
- **FINISH:** Smooth rubber
- **FITTINGS:** 3/8" M x 3/8" F QC
- **MAX PRESSURE:** 4000 PSI

\$53.99 PW85225228

25' - 1/4" PACKAGED HIGH-PRESSURE HOSE

MTM HYDRO



- **MATERIAL:** PVC/Plastic
- **FITTINGS:** M22F - 14mm Ends
- **MAX PRESSURE:** 3200 PSI

\$25.10 MTM300130



UBERFLEX™ HOSE ASSEMBLIES

PROPULSE



- **REINFORCEMENT:** Single Layer Textile Braid
- **HOSE SIZE:** 1/4" ID
- **IMPULSE LIFE:** 100,000+
- **WORKING PRESSURE (MAX):** 3100 PSI

- **COVER:** Matte Textured Finish
- **MAX TEMP:** 140°F
- **BURST (MIN):** 3:1 Working Pressure

PRICE	KR #	LENGTH	COLOR
\$30.32	HUFC254BK	25'	BLACK
\$52.77	HUFC504BK	50'	
\$31.58	HUFC254BL	25'	BLUE
\$55.60	HUFC504BL	50'	

NOT FOR HOT WATER OR STEAM

3/8" HOSE



UBERFLEX™ DROP HOSE

PROPULSE



- **REINFORCEMENT:** Single Layer Textile Braid
- **HOSE SIZE:** 3/8" ID
- **IMPULSE LIFE:** 200,000+
- **BURST (MIN):** 3:1 Working Pressure

- **COVER:** Matte Textured Finish
- **MAX TEMP:** 140°F
- **MAX WORKING PRESSURE:** 4000 PSI

\$19.49	HUF126BK	12'	BLACK
\$21.80	HUF156BK	15'	
\$24.39	HUF186BK	18'	
\$20.27	HUF126BL	12'	BLUE
\$22.79	HUF156BL	15'	
\$25.57	HUF186BL	18'	

NOT FOR HOT WATER OR STEAM

CLEANSTREAM™ DROP HOSE

PROPULSE



- **REINFORCEMENT:** 1-Wire Braid
- **HOSE SIZE:** 3/8" ID
- **IMPULSE LIFE:** 200,000+
- **BURST (MIN):** 3:1 Working Pressure

- **COVER:** Matte Textured Finish
- **MAX TEMP:** 140°F
- **MAX WORKING PRESSURE:** 4000 PSI

\$27.46	HCS126BK	12'	Black
\$30.39	HCS156BK	15'	
\$33.34	HCS186BK	18'	
\$43.32	HCS256BK	25'	
\$68.88	HCS506BK	50'	
\$28.55	HCS126BL	12'	Blue
\$31.78	HCS156BL	15'	
\$34.93	HCS186BL	18'	
\$45.85	HCS256BL	25'	
\$73.50	HCS506BL	50'	

NOT FOR HOT WATER OR STEAM

PRESSURE WASH

3/8" HOSE

3000 PSI WIREBRAID HOSE ASSEMBLIES

CONTINENTAL: ASSEMBLED BY KLEEN-RITE CORP.



- Hose guards available
- Other ends available upon request
- Custom lengths available



PRICE	KR #	LENGTH	COLOR	HOSE SIZE	FITTINGS
\$43.59	HA256WBL1414	25'	Blue	3/8"	3/8" MPE x 3/8" MPE
\$46.44	HA256WBK1414	25'	Black		
\$82.13	HA506WBL1414	50'	Blue		
\$87.76	HA506WBK1414	50'	Black		
\$121.22	HA756WBL1414	75'	Blue		
\$129.66	HA756WBK1414	75'	Black		
\$173.18	HA1006WBK1111	100'	Black		
\$160.32	HA1006WBL1414	100'	Blue		
\$171.57	HA1006WBK1414	100'	Black		
\$174.20	HA1006WBK1415	100'	Black		
\$176.82	HA1006WBK1515	100'	Black		3/8" M Swivel x 3/8" M Swivel
\$162.94	HA1006WBL1415	100'	Blue		3/8" MPE x 3/8" M Swivel
\$165.57	HA1006WBL1515	100'	Blue		3/8" M Swivel x 3/8" M Swivel
\$255.39	HA1506WBK1414	150'	Black		3/8" MPE x 3/8" MPE

4000 PSI HOSE ASSEMBLIES

CONTINENTAL: ASSEMBLED BY KLEEN-RITE CORP.



PRICE	KR #	LENGTH	COLOR	HOSE SIZE	FITTINGS
\$55.16	HA256HPBL1414	25'	Blue	3/8"	3/8" MPE x 3/8" MPE
\$60.56	HA256HPBK1414	25'	Black		
\$120.94	HA506HPBL1414	50'	Blue		
\$102.08	HA506HPBK1414	50'	Black		
\$179.02	HA756HPBL1414	75'	Blue		
\$151.01	HA756HPBK1414	75'	Black		
\$237.10	HA1006HPBL1414	100'	Blue		
\$199.95	HA1006HPBK1414	100'	Black		
\$353.25	HA1506HPBL1414	150'	Blue		
\$297.83	HA1506HPBK1414	150'	Black		

HOT CLEAN - ARM-A-FLEX

PROPULSE



- REINFORCEMENT: 2-Wire Braid
- HOSE SIZE: 3/8" ID
- MAX WORKING PRESSURE: 4785 PSI
- BURST (MIN): 4:1 Working Pressure
- COVER: Ultra-High Molecular Weight Polyethylene
- INLETS/OUTLETS: 3/8" - Swivel & solid ends
- MAX TEMP: 250°F
- IMPULSE LIFE: 200,000

\$116.76	HAF506BK	50' Length
\$208.11	HAF1006BK	100' Length

NOT FOR STEAM

HOT CLEAN HOSE ASSEMBLIES

PROPULSE



- REINFORCEMENT: 2-Wire Braid
- HOSE SIZE: 3/8" ID
- IMPULSE LIFE: 200,000+
- BURST (MIN): 3:1 Working Pressure
- COVER: Wrapped Textured Rubber
- MAX TEMP: 250°F
- MAX WORKING PRESSURE: 6000 PSI

\$87.58	HHC506G	50' Length
\$166.65	HHC1006G	100' Length

NOT FOR STEAM

3/8" KOBRAJET HOSE

MTM HYDRO



- REINFORCEMENT: Single Steel Wire
- HOSE SIZE: 3/8" ID
- INLET: 3/8" M Snap Coupler
- MAX WORKING PRESSURE: VARIES - See Chart Below
- COVER: Non-marking rubber
- MAX TEMP: 310°F
- OUTLET: 3/8" F Snap Coupler

MTM290129



MTM300053

PRICE	KR #	LENGTH	PSI	COLOR	PRICE	KR #	LENGTH	PSI	COLOR
\$51.98	MTM295222	25'	4000	Gray	\$141.94	MTM295228	75'	6000	Gray
\$82.52	MTM295223	50'			\$181.73	MTM295229	100'		
\$114.45	MTM295224	75'			\$82.52	MTM295223	50'	4000	
\$144.97	MTM295225	100'			\$144.97	MTM295225	100'		
\$60.98	MTM295226	25'	6000	Black	\$91.06	MTM300053	50'	6000	Black
\$100.76	MTM295227	50'			\$171.11	MTM300055	100'		

CALIFORNIA PROPOSITION 65: Some items on this page may fall under the Proposition 65 act. Please consult the State of California Proposition 65 list (oehha.ca.gov/proposition-65/proposition-65-list) to learn more and to see a comprehensive list of Proposition 65 chemicals.



605

PRESSURE WASH

3/8" HOSE

PW85238215



PW85238211

3/8" HIGH-PRESSURE HOSE

BE PRESSURE



- **REINFORCEMENT:** Varies
- **HOSE SIZE:** 3/8" ID
- **COVER:** Non-marking rubber
- **TEMPERATURE (MAX):** 310°F

PRICE	KR #	LENGTH	PSI	COLOR	FITTINGS	TYPE
\$112.50	PW85238115	100'	4000	Gray	3/8" M X F Brass QC Swivel End	Single Braid
\$63.50	PW85238155	50'		Gray		
\$146.25	PW85238211	100'	6000	Black	3/8" M X F Brass QC Bend Restricted	Double Braid
\$145.50	PW85238215	100'		Gray		
\$83.99	PW85238251	50'		Black	3/8" M X F Stainless Steel QC Swivel End	
\$91.50	PW85238255	50'		Gray		

HOT/COLD HIGH-PRESSURE HOSE

HYDRA-FLEX



- **REINFORCEMENT:** Wire Braid
- **HOSE SIZE:** 3/8" ID
- **WORKING PRESSURE (MAX):** 4000 PSI
- **COVER:** Rubber
- **INLETS/OUTLETS:** 3/8" M x 3/8" F quick connects
- **TEMPERATURE (MAX):** -40 to 310°F

\$152.86	PWP0235	100' Length
\$255.24	PWP0240	150' Length
\$331.93	PWP0245	200' Length



SEWER HOSE

SEWER HOSE

SUTTNER



- **INLETS/OUTLETS:** 1/8" x 1/4"
- **WORKING PRESSURE (MAX):** 3000 PSI
- **TEMPERATURE (MAX):** 140°F

\$51.96	SUT084290050	50' Length
\$86.96	SUT084290100	100' Length



SUPERBALL KITS

SUPERBALL KITS

SUTTNER



- Reduces abuse and abrasions that damage hose cover
- 16" spacing is recommended
- Helps keep hoses clean and reduces damming of water around the hose
- Easy handling and dragging of hose
- Simple installation
- 36 pieces (enough for a 50' hose)

PRICE	KR #	DESCRIPTION	COLOR
\$48.92	SUT000505	For most 3/8" single braid hose (NOT Continental brand). Maximum O.D. of .693"	Orange
\$48.92	SUT000515	For most 3/8" double braid hose (INCLUDES Continental brand). Maximum O.D. of .77"	Red
\$48.92	SUT000516	For most 1/4" single braid hose (NOT Continental brand). Maximum O.D. of .44"	Blue

CHECK HOSE DIAMETER BEFORE ORDERING



HOSE KITS & SWIVELS



M22 GARDEN HOSE KIT

KLEEN-RITE CORP.



KIT INCLUDES:

- 1 - D10035 quick connect coupler - 3/8" with M22 male end
- 1 - D10037 quick connect plug - 3/8" with M22 female end

\$8.01 KRK3104



NPT HIGH-PRESSURE HOSE KIT

KLEEN-RITE CORP.



KIT INCLUDES:

- 1 - D11008 quick disconnect - 3/8" female plug
- 1 - D10004 quick disconnect - 3/8" male socket

\$5.40 KRK3106



BRASS HOSE REEL SWIVEL

J.E. ADAMS



- 3000 PSI | 10 GPM | 1/2" FPT | 300°F

\$42.81	SW7475	Swivel
\$12.15	SW7475K	Repair Kit

DON'T SEE WHAT YOU NEED HERE?

We've expanded our Pressure Washing offerings, just check out the Pressure Wash section of the Kleen-Rite website, or request our pressure wash catalog today!

PRESSURE WASH

PRESSURE CLEANING PUMPS



AXD-G SERIES

CP65010005



BXD SERIES

CP65251002



LWD-E SERIES

CP63030509



ZWD SERIES

CP63051503



RW SERIES

CP65171300

COMET PRESSURE WASH PUMPS

COMET



PRICE	KR #	MODEL #	SERIES	GPM	PSI	RPM	ENG. SHAFT
AXD - ELECTRIC FLANGE, HOLLOW SHAFT							
\$311.63	CP65010010	AXD2020E	AXD	1.9	2000	3400	5/8"
AXD - GAS FLANGE, HOLLOW SHAFT							
\$326.96	CP65010025	AXD2527G	AXD	2.5	2700	3400	3/4"
\$339.11	CP65010005	AXD3020G	AXD	2.7	2000		
BXD - GAS FLANGE - HOLLOW SHAFT							
\$157.58	CP65251002	BXD2527G	BXD	2.4	2700	3400	3/4"
TRIPLEX PLUNGER - ELECTRIC FLANGE, HOLLOW SHAFT							
\$355.05	CP63030509	LWD3020E	LWD	3	2000	3400	5/8"
TRIPLEX PLUNGER - GAS FLANGE, HOLLOW SHAFT							
\$342.28	CP63031700	LWD2525G	LWD	2.5	2700	3400	3/4"
ZWD - GAS FLANGE, HOLLOW SHAFT							
\$510.79	CP63051503	ZWD4040G-K	ZWD	4	4000	3400	1"
\$385.09	CP6305010400	ZWD3030G	ZWD	3	3200		3/4"
\$485.93	CP6305090000	ZWD4040G	ZWD	4	4000		1"
RW SERIES - SOLID SHAFT							
\$605.38	CP65171300	RW5535S	RW	5.5	3500	1450	24mm

OIL SEAL KIT	VALVE KIT
CP50190079	CP50250014
CP50190079	CP50250014
CP50190079	CP50250014
CP50190667	CP50250027
CP50190041	CP50250011
CP50190041	CP50250011
CP50190065	CP50250011
CP50190065	CP50250011
CP50190065	CP50250011
-	CP50250011

New!



PUP329L



GXH2525-111H



P200 SERIES

PRESSURE CLEANING PUMPS

GIANT



PRICE	PART #	GPM	PSI	RPM
\$433.95	PUP329L PUP329R	4.0	4000	3450
\$181.02	PUGXH2525111H	2.5	2500	3450
\$405.06	PUP218R	3.4	2500	1750
\$405.06	PUP219L PUP219R	4.2	2500	1750
\$423.90	PUP316R PUP316L	4.0	3350	1450
\$423.90	PUP317R PUP317L	3.5	3000	1750
\$423.90	PUP321R	3.8	3500	3450

SEAL KIT	VALVE KIT
PU09507	PU09116
PU09465	PU09466
PU09164	PU09116
PU09164	PU09116
PU09119	PU09116
PU09119	PU09116
PU09152	PU09116



GPHTCK3623S

EMPEROR SERIES FROM GENERAL PUMP



GP0100450 SERIES 220 OIL

EMPEROR SERIES FROM GP

- **FLOW:** 21/25 GPM
- **RPM:** 1150/1350
- **PSI:** 1500/1300
- **SHAFT OD:** 30mm

FEATURES & BENEFITS:

- Ceramic plungers with a patent-pending inlet/outlet valve cage
- Nickel-plated forged brass manifold with an exclusive lifetime warranty
- Heavy-duty tapered roller bearings
- Specifically designed to handle rigorous duty cycles, high temperatures & chemicals
- Ideal for use in car wash and other high-pressure applications

- 2½ gallon 50WT oil
- For use with GPHTCK4050S and GPHTCK3623S pumps

\$75.19 GP0100450

\$2,954.60 GPHTCK3623S Right Side Shaft

ALL PRICES ARE F.O.B. AND ARE SUBJECT TO CHANGE WITHOUT NOTICE • NO C.O.D.'S

1-800-233-3873 • (717) 684-6721 • FAX (800) 446-0495 • KLEENRITE.COM

607

PRESSURE WASH

PRESSURE CLEANING PUMPS

DIRECT DRIVE PRESSURE CLEANING PUMPS

GENERAL PUMP

*** NEED 3 PER PUMP**



GPTT9061EBF

PRICE	PART #	GPM	PSI	RPM	MOTOR TYPE	SEAL KIT	VALVE KIT	PACKING KIT
\$310.73	GPTT9061EBF	2.11	1500	3400	Electric	GPK97	GPK01	GPK96*
\$310.73	GPTT9071EBF	2.8	1500		Electric	GPK97	GPK01	GPK96*
\$289.64	GPTP2530J34	2.88	2500		Gasoline	GPK97	GPK123	GPK96*



GPEZ3040G

PULLEY DRIVE PRESSURE CLEANING PUMPS

GENERAL PUMP

*** NEED 3 PER PUMP**



GPTS1511

PRICE	PART #	GPM	PSI	RPM	MOTOR TYPE	SEAL KIT	VALVE KIT	PACKING KIT
\$497.83	GPT1011L (Left Shaft)	4.5	1500	1125	Gasoline	GPK69	GPK01	GPK28*
\$545.34	GPTS1511	4.0	3500	1450	Gasoline	GPK69	GPK01	GPK28*
\$569.40	GPTS2021L (Left Shaft) GPTS2021R (Right Shaft)	5.6	3500	1450	Gasoline	GPK69	GPK01	GPK28*
\$433.66	GPEZ2542E	4.2	2500	1750	Electric	GPK127	GPK123	GPK131*
\$433.66	GPEZ2536E	3.6	2500	1750	Electric	GPK127	GPK123	GPK131*
\$433.66	GPEZ3040G	4.0	3000	3400	Gasoline	GPK88	GPK123	GPK130*
\$846.31	GPTSF2021	8.5	3600	1750	Gasoline	GPK170	GPK169	GPK171*



GPTP2530J34-PMR

PMREZ SERIES PUMPS - READY TO USE OUT OF BOX

GENERAL PUMP



PRICE	PART #	GPM	PSI	RPM	MAX. FLUID TEMP.	INLET	OUTLET	INCLUDES
\$409.76	GPTP2530J34-PMR	2.88	2500	3400	165° F	3/8-19 BSP-F	1/4-19 BSP-F	Gas Flange & Unloader
\$407.24	GPEZ4040G-PMR	4	4000			1/2-14 BSPP-F	3/8-19 BSPP-F	
\$365.86	GPEP1313G8-PMR	4	4000			1/2-14 BSPP-F	3/8-19 BSPP-F	



1/2" THERMAL PROTECTOR RELIEF VALVE

GENERAL PUMP



- 145°F Relief Temp.
- 1/2" NPT-M
- Brass construction
- Protect pump from heat-build up while in bypass mode

\$5.32 **GPP2100612**

INDUSTRIAL FOOT VALVE

GENERAL PUMP



- 10 GPM
- 5000 PSI
- 3/8-18 NPT-F Inlet
- 1/4-1/8 NPT-F Outlet
- 320°F Max. Temp.

\$196.21 **GPDFV5010**



ARXWAM8G35N

ARRC35G25N

PRESSURE CLEANING PUMPS

AR NORTH AMERICA PRESSURE CLEANING



\$421.23	ARKA35G40HEF17	3 1/2 GPM	4000 PSI	1750 RPM	1 1/8" Shaft
\$397.03	ARKA35G40HN	3 1/2 GPM	4000 PSI	1750 RPM	24mm Shaft
\$397.03	ARKA4G40HN	4 GPM	4000 PSI	1750 RPM	24mm Shaft
\$115.23	ARMV25G24D	2 1/2 GPM	2400 PSI	3400 RPM	3/4" Shaft
\$115.23	ARMW22G24EZ	2.2 GPM	2400 PSI	3400 RPM	7/8" Shaft
\$250.32	ARRCA35G25N	3 1/2 GPM	2500 PSI	1750 RPM	24mm Shaft
\$397.03	ARRK1528HN	3.96 GPM	4000 PSI	1450 RPM	24mm Shaft
\$385.41	ARRKV35G40HD24	3 1/2 GPM	4000 PSI	3400 RPM	1" Shaft
\$426.07	ARRKV4G40HD	4 GPM	4000 PSI	3400 RPM	1" Shaft
\$242.10	ARSJV25G27D-F7	2 1/2 GPM	2700 PSI	3400 RPM	3/4" Shaft
\$789.21	ARSXWA55G50	5 1/2 GPM	5000 PSI	1750 RPM	24mm Shaft
\$295.35	ARXWAM8G35N	8 GPM	3500 PSI	1750 RPM	24mm Shaft
\$314.72	ARXMT25G26DF25	2 1/2 GPM	2600 PSI	3400 RPM	3/4" Shaft
\$634.28	ARXTA2G15EBAF8	2.11 GPM	1800 PSI	1750 RPM	3/4" Shaft
\$14.22	AR1836				1/2" Rail Kit
\$18.76	AR1836H				1 5/8" Rail Kit

PRESSURE CLEANING PUMPS

RCV3G27-PKG RCV BOXED PUMP PACKAGE

AR NORTH AMERICA PUMPS



INCLUDES:

- RCV3G25D-F7V21Pump
- TPP140Thermal Relief Valve
- AR1269120Detergent Tube with Filter
- AL-QC3/8BQuick Connect Coupler
- AR73653/8" M Nipple
- AR73663/4" F Nut
- AR7369Inlet Filter
- Gas Engine FlangeF7
- **MAX FLOW:** 3 GPM
- **MAX PRESSURE:** 2500 PSI
- **MAX SPEED:** 3400 RPM
- **SHAFT SIZE:** 3/4"

\$309.92 **ARRCV3G27-PKG**

RSV4G40-PKG RSV BOXED PUMP PACKAGE

AR NORTH AMERICA PUMPS



INCLUDES:

- RSV4G40HDF40EZ ...Pump
- AR73653/8" M Nipple
- AR73663/4" F Nut
- AR7369Inlet Filter
- DETHOSE-FILDetergent Hose with Filter
- AL-QC3/8BQuick Connect Coupler
- Gas Engine FlangeF40
- **MAX FLOW:** 4 GPM
- **MAX PRESSURE:** 2500 PSI
- **MAX SPEED:** 3400 RPM
- **SHAFT SIZE:** 1"

\$325.90 **ARRSV4G40-PKG**

RRV4G40-PKG RRV BOXED PUMP PACKAGE

AR NORTH AMERICA PUMPS



INCLUDES:

- RRV4G40HD-F24Pump
- TPP140Thermal Relief Valve
- AR73663/4" F Nut
- AR73681/2" M Nipple
- AR7369Inlet Filter
- AR20242Gymatic Unloader
- AL-QC3/8BQuick Connect Coupler
- Gas Engine FlangeF24
- **MAX FLOW:** 4 GPM
- **MAX PRESSURE:** 4000 PSI
- **MAX SPEED:** 3400 RPM
- **SHAFT SIZE:** 1"

\$415.96 **ARRRV4G40-PKG**

RRV4G40-VRT-PKG RRV BOXED PUMP PACKAGE

AR NORTH AMERICA PUMPS



INCLUDES:

- RRV4G40D - F24 pump
- Brass Line Strainer w/ Cone Filter, GH Inlet
- 3/8" QC steel plug
- 3/8" QC brass socket
- VRT3-310 EZ Start adjustable pressure unloader
- 1/2" Black bypass hose thermal relief valve
- **MAX FLOW:** 4 GPM
- **MAX PRESSURE:** 4000 PSI
- **MAX SPEED:** 3400 RPM
- **SHAFT SIZE:** 1" Hollow

\$380.62 **ARRRV4G40-VRT-PKG**

RKV4G40-PKG REPLACEMENT PLUNGER PUMP KIT PACKAGE

AR NORTH AMERICA PUMPS



INCLUDES:

- Kit Manual
- RRV4G40HD-F24 VR3 - Pump
- TPP140 - Thermal Relief Valve
- VR35 Unloader
- F24 Gas Engine Flange
- AR7300 - 1/2" Garden Hose Adaptor w/ Spring
- **MAX FLOW:** 4 GPM
- **MAX PRESSURE:** 4000 PSI
- **MAX SPEED:** 3400 RPM
- **SHAFT SIZE:** 1" Hollow

\$522.99 **ARRKV4G40-PKG**

PRESSURE WASH

PRESSURE CLEANING PUMPS



PRESSURE CLEANING PUMPS CAT PUMPS



PRICE	PART #	GPM	PSI	RPM	ENG. SHAFT
\$413.70	PU2SF22ES	2.2	2000	3450	5/8" Electric
\$420.35	PU2SF22ELS	2.2	2000	1725	5/8" Electric
\$413.70	PU2SF30ES	3.0	1500	3450	5/8" Electric
\$452.10	PU2SF30GS	3.0	2000	3450	3/4" Gas
\$446.98	PU2SFX30GS	3.0	2000	3450	3/4" Gas
\$457.73	PU2SF35GS	3.5	2000	3450	3/4" Gas
\$410.63	PU4DX29GUIF	2.9	2600	3450	3/4" Gas
\$430.62	PU4SPX32G1I	3.2	3000	3450	1" Gas
\$583.13	PU66DX40G1I	4.0	4000	3400	1" Gas
\$317.91	PU4PPX30GSI	2.7	3000	3450	3/4" Gas
\$318.44	PU4PPX25GSI	2.5	3300	3450	3/4" Gas

SEAL KIT	VALVE KIT
PU34053	PU34052
PU34053	PU34052
PU34053	PU34052
PU34053	PU34052
PU34053	PU34056
PU34053	PU34052
PU33053	PU76978
PU76977	PU76976
PU34262	PU34260 x 2
PU76124	PU76134
PU76124	PU76134

REGULATORS & UNLOADERS

7860 UNLOADER WITH FIXED CHEMICAL INJECTOR

CAT PUMPS

- MAX. PRESSURE: 4000 PSI
- MAX. FLOW: 5 GPM
- INLET: 1/2" NPT-F
- OUTLET: 3/8" NPT-M
- MATERIAL: Brass

\$153.75 PU07860

USED ON 66DX SERIES ONLY

7082 PRESSURE REGULATOR

CAT PUMPS

- MAX. PRESSURE: 3200 PSI
- MAX. FLOW: 8 GPM
- INLET: 3/8" NPT-F
- OUTLET: 3/8" NPT-F
- MATERIAL: Brass

\$63.13 PU7082

7542 MULTIPLE GUN PRESSURE UNLOADER

CAT PUMPS

- MAX. PRESSURE: 4060 PSI
- MAX. FLOW: 21 GPM
- INLET: 1/2" NPT-F
- OUTLET: 1/2" NPT-F
- MAX. TEMP: 140°F
- MATERIAL: Brass

\$177.50 PU07542

7500S, 7500XS, & 7600 UNLOADERS

CAT PUMPS

- INLET: 3/8" NPT-M
- OUTLET: 3/8" NPT-M
- MAX. TEMP: 180°F
- MATERIAL: Brass

PRICE	MODEL #	TYPE	PSI	GPM
\$87.50	PU7500	Model SF	2000	0.5-6
\$90.63	PU7500XS	Model SFX	2000	0.5-6
\$154.38	PU07600	Model 4SF	3500	2-5

7581 PRESSURE SENSITIVE REGULATING UNLOADER

CAT PUMPS

- MAX. PRESSURE: 2300 PSI
- MAX. FLOW: 6 1/2 GPM
- INLET: 3/8" NPT-M
- OUTLET: 3/8" NPT-M
- MATERIAL: Brass

\$66.88 PU07581

ST-261 UNLOADER

SUTTNER



- MAX. FLOW: 8 GPM
- INLET: 3/8" FPT
- OUTLET: 3/8" FPT
- BYPASS: 1/4"
- MAX. TEMP: 176°F

PRICE	PART #	DESCRIPTION	MAX. PSI
\$54.73	SUT261	Without Switch	3600
\$99.01	SUT261S	With Microswitch	3600
\$39.95	SUT5	Microswitch	4380

AR NORTH AMERICA UNLOADERS

AR NORTH AMERICA



- MAX. FLOW: 10.5 GPM
- INLET: 2 x 3/8" F
- OUTLET: 3/8"
- MAX. TEMP: 194°F
- BYPASS: 2 x 3/8" F
- KNOB: Yes

PRICE	PART #	MODEL	PSI	KNOB
\$44.27	ARVRT3160	VRT3-160	2320	Yellow
\$44.27	ARVRT3250	VRT3-250	3650	Blue
\$44.25	ARVRT3310	VRT3-310	4500	Black



REGULATORS & UNLOADERS



PULSAR4HP

GENERAL PUMP

- **MAX. PRESSURE:** 4500 PSI
- **MAX FLOW:** 10½ GPM
- **MAX TEMP:** 195°F
- **INLET:** 2 x ¾" NPT-F
- **OUTLET:** ¾" NPT-F
- **BYPASS:** 2 x ¾" NPT-F
- **SPRING COLOR:** Blue

\$52.27 GPU831D



ZK7 SERIES FLOW SENSITIVE UNLOADERS

GENERAL PUMP

- **MAX. PRESSURE:** 3500 PSI*
- **MAX FLOW:** VARIES - See Chart Below
- **INLET:** ¾"-19 BSPP - F
- **OUTLET:** ¾"-19 BSPP - M
- **BYPASS:** ¾"-19 BSPP - F
- **MAX TEMP:** 165°F

PRICE	KR #	FLOW
\$114.06	GPUZK70	2.1 - 3.0 GPM
\$114.06	GPUZK71	3.0 - 4.2 GPM
\$114.06	GPUZK72	4.2 - 6.6 GPM
\$114.06	GPUZK73	6.6 - 10.6 GPM

*Maximum Pressure 3500 PSI when valve is marked GPV. Unmarked valves are 3000 PSI rated.

ZK3 SERIES FLOW SENSITIVE UNLOADERS

GENERAL PUMP

- **MAX. PRESSURE:** 1500 PSI
- **MAX FLOW:** VARIES - See Chart Below
- **INLET:** ¾"-19 BSP-F
- **OUTLET:** ¾"-19 BSP-M
- **BYPASS:** ¾"-14 BSP-M
- **MAX TEMP:** 165°F

PRICE	KR #	FLOW
\$89.61	GPUZK30	2.1 - 3.0 GPM
\$89.61	GPUZK31	3.0 - 4.2 GPM
\$89.61	GPUZK32	4.2 - 5.5 GPM



ZK5 SERIES FLOW SENSITIVE UNLOADERS

GENERAL PUMP

- **MAX. PRESSURE:** 2900 PSI
- **MAX FLOW:** VARIES - See Chart Below
- **INLET:** ¾" NPT-F
- **OUTLET:** ¾" NPT-M
- **BYPASS:** ¾" NPT-M
- **MAX TEMP:** 165°F

PRICE	KR #	FLOW
\$95.14	GPUZK51	3.0 - 4.2 GPM
\$95.14	GPUZK52	4.2 - 6.6 GPM
\$95.14	GPUZK53	6.6 - 10.8 GPM



YVB135KDM CONTROL SET UNLOADER

GENERAL PUMP

- **MAX. PRESSURE:** 2600 PSI
- **MAX FLOW:** 6½ GPM
- **INLET:** ¾" BSP-F
- **OUTLET:** ¾" BSP-M
- **BUILT-IN BYPASS:** ½" NPT-F
- **MAX TEMP:** 195°F
- **MATERIALS:** Brass Body, Stainless Steel

\$72.27 GPU135KDM



YU5075K PRESSURE TRAPPING UNLOADER

GENERAL PUMP

- **MAX PRESSURE:** 5650 PSI
- **MAX FLOW:** 10.5 GPM
- **INLET:** ¾" BSP-M
- **OUTLET:** ¾" BSP-F
- **BYPASS:** ½" BSP-F
- **MAX TEMP:** 195°F
- **MATERIALS:** Brass, Stainless Steel, Buna-N

\$149.51 GPU5075K



ZKW1 SERIES CONTROL SET UNLOADER

GENERAL PUMP

- **MAX PRESSURE:** 1600 PSI
- **MAX FLOW:** 2 - 3 GPM
- **CHEM INLET:** ¼" I.D. Hose
- **OUTLET:** ¾"-19 BSP-M
- **INLET:** VARIES - See Chart Below
- **MAX TEMP:** 165°F

PRICE	KR #	INLET PORT
\$110.81	GPUZKW1	¾"-19 BSP-F
FOR PUMPS		
TT551, TT561, TT741, TT751, TT901, TT931, T9051, TT9061, TT9071, TS1021		

PRICE	KR #	INLET PORT
\$110.81	GPUZKW11L	½"-14 BSP-F
FOR PUMPS		
T711, T911, T991, T9951, T9961		



ZKW2 SERIES TRAPPER PRESSURE CONTROL SET UNLOADER

GENERAL PUMP

- **MAX PRESSURE:** 3000 PSI
- **MAX FLOW:** 2.9 - 4.5 GPM
- **CHEM. INLET:** ¼" I.D. Hose
- **OUTLET:** ¾"-19 BSPP-M
- **INLET:** ½"-14 BSPP-F
- **MAX TEMP:** 200°F

PRICE	KR #
\$129.27	GPUZKW21
FOR PUMPS	
TS1371, TT1411, TT1611, TT9351, TT9441, TT9971, All EZ Series	

PRICE	KR #
\$129.27	GPUZKW21L
FOR PUMPS	
T811, TS1011, TS1311, TS1331, TS1511, TS1711, TS2011, T9131, T9211	



PRESSURE WASH

REGULATORS & UNLOADERS



YBRV5325 BALANCED RELIEF VALVE

GENERAL PUMP



- RATED PRESSURE: 2900 PSI
- MAX FLOW: 53 GPM
- INLET: 3/4"-14 NPT-F
- BYPASS: 1/2"-14 NPT-F
- MAX TEMP: 195°F
- MATERIAL: Brass, Stainless Steel, Buna-N

PRICE	PART #	DESCRIPTION
\$163.35	REK5325	Valve
\$41.17	REK5325K	Repair Kit



BALANCED UNLOADERS

KLEEN-RITE CORP.



- MAX FLOW: 8 GPM
- INLET: 3/8" FPT
- OUTLET: 3/8" FPT
- BYPASS: 1/4"
- MAX TEMP: 200°F
- SEALS: Buna-N
- BODY: Brass body

PRICE	KR #	PSI	SPRING
\$73.98	RE7100	800-2000	Brown
\$96.01	RE7150	400-1000	Yellow
\$89.09	RE7300	1500-3000	Red

\$6.99	RE7100K	Repair Kits for all models
---------------	----------------	----------------------------



New!

22090 PRESSURE-ACTUATED UNLOADER

GIANT



- MAX PRESSURE: 2175 PSI
- MAX FLOW: 53 GPM
- INLET: 1" FNPT
- OUTLET: 1" FNPT
- BYPASS: 1" BSP
- MAX TEMP: 194°F

PRICE	PART #	DESCRIPTION
\$400.19	PU22090	Valve
\$67.81	PU09182	Repair Kit



New!

25170-2.1 FIXED BRASS INJECTOR

GIANT



- MAX PRESSURE: 4000 PSI
- MAX FLOW: 53 GPM
- INLET: 3/8" FNPT
- OUTLET: 3/8" FNPT
- MAX TEMP: 194°F

\$13.23	PU25170-2.1	Valve
----------------	--------------------	-------



22971C HIGH FLOW UNLOADER

GIANT



- MAX. PRESSURE: 1740 PSI
- MAX FLOW: 35.7 GPM
- INLET: 3/4" FNPT
- OUTLET: 3/4" FNPT
- BYPASS: 3/4" BSP
- MAX TEMP: 158°F
- MATERIAL: Brass

PRICE	PART #	DESCRIPTION
\$321.35	PU22971	Unloader
\$124.99	PU09461	Repair Kit



22760A UNLOADER

GIANT



- MAX. PRESSURE: 3045 PSI
- MAX FLOW: 8 GPM
- INLET: 3/8" FNPT
- OUTLET: 3/8" FNPT
- BYPASS: (2) 1/4" BSP
- MAX TEMP: 160°F
- MATERIAL: Brass, Stainless Steel

PRICE	PART #	DESCRIPTION
\$92.12	PU22760	Unloader
\$5.20	PU09108	Repair Kit



22600 & 22600A FLOW ACTUATED UNLOADERS

GIANT



- INLET: 3/8" FNPT
- OUTLET: 3/8" FNPT
- MAX TEMP: 160°F
- MATERIAL: Brass

PRICE	PART #	FLOW	PRESSURE
\$104.55	PU22648	1.5 - 4 GPM	3000 PSI
\$104.55	PU22655	3.0 - 5.5 GPM	3000 PSI
\$13.19	PU22666	22600 Series Repair Kit	

\$102.38	PU22650	3.0 - 4.5 GPM	3000 PSI
\$151.94	PU22654A	3.5 - 4.8 GPM	4000 PSI
\$9.70	PU22666A	22600A Series Repair Kit	

\$47.60	PU22695A	Long Seal Kit ONLY for 22654A	
----------------	-----------------	-------------------------------	--



ADJUSTABLE UNLOADERS

GIANT



- MAX FLOW: 13 GPM
- INLET: 1/2" FNPT
- OUTLET: 1/2" FNPT
- BYPASS: 1/2" BSP
- MAX TEMP: 160°F
- MATERIAL: Bronze housing, stainless parts

PRICE	PART #	PSI	COLOR
\$127.46	PU22910	800	Silver
\$98.50	PU22911	1400	Yellow
\$98.50	PU22912	2000	Red
\$98.50	PU22913	3000	Orange

\$20.76	PU12099	Repair Kit For All Models
----------------	----------------	---------------------------



CHEMICAL INJECTORS

FIXED EXTERNAL CHEMICAL INJECTOR KITS

X-JET



SPECIFICATIONS:

- **PRESSURE:** 2000 to 4000 PSI
- **FLOW:** See Specific Model Below
- **MAX. TEMP:** 190°F
- **INLET:** 1/4" QC Plug
- **CHEM PORT:** 1/8" MPT x 3/8" Hose Barb

INCLUDED ACCESSORIES:

- 15' X-Jet Suction Hose with hose barb
- Long range nozzle
- Low-pressure close range nozzle
- 15-piece color coded proportioner tip set
- Shut off ball valve
- Mushroom strainer

PRICE	KR #	GPM
\$126.75	XJET-07K	2 - 2.5
\$126.75	XJET-09K	3 - 3.5
\$126.75	XJET-13K	4 - 4.5

PRICE	KR #	GPM
\$126.75	XJET-16K	5 - 6.5
\$126.75	XJET-20K	7 - 8
\$126.75	XJET-25K	8.5+

X-JET M5 KIT - ADJUSTABLE EXTERNAL INJECTOR

X-JET



SPECIFICATIONS:

- **PRESSURE:** 2000 to 4000 PSI
- **FLOW:** See Specific Model Below
- **MAX. TEMP:** 190°F
- **INLET:** 1/4" QC Plug
- **CHEM PORT:** 1/8" MPT x 3/8" Hose Barb

INCLUDED ACCESSORIES:

- 15' X-Jet suction hose with hose barb
- Twist-adjust M5 nozzle for spray patterns between 5° and 60°
- 15-piece color coded proportioner tip set
- Shut off ball valve
- Mushroom strainer

PRICE	KR #	GPM
\$141.75	XJETM5-07K	2 - 2.5
\$141.75	XJETM5-09K	3.0 - 3.5
\$141.75	XJETM5-13K	4 - 4.5

PRICE	KR #	GPM
\$141.75	XJETM5-16K	5 - 6.5
\$141.75	XJETM5-20K	7 - 8
\$141.75	XJETM5-25K	8.5+

THE ORIGINAL X-JET NOZZLE (FIXED) LONG & CLOSE RANGE SPRAY PATTERNS

X-JET



• REPLACEMENT NOZZLE ASSEMBLY ONLY

PRICE	PART #	GPM
\$79.50	XJET-07K-N	2 - 2.5
\$79.50	XJET-09K-N	3 - 3.5

PRICE	PART #	GPM
\$79.50	XJET-13K-N	4 - 4.5
\$79.50	XJET-16K-N	5 - 6.5

PRICE	PART #	GPM
\$79.50	XJET-20K-N	7 - 8
\$79.50	XJET-25K-N	8.5+

X-JET M5 NOZZLE (ADJUSTABLE) - 5-60° SPRAY PATTERN

X-JET



• REPLACEMENT NOZZLE ASSEMBLY ONLY

PRICE	PART #	GPM
\$96.00	XJETM5-07K-N	2 - 2.5
\$96.00	XJETM5-09K-N	3 - 3.5

PRICE	PART #	GPM
\$96.00	XJETM5-13K-N	4 - 4.5
\$96.00	XJETM5-16K-N	5 - 6.5

PRICE	PART #	GPM
\$96.00	XJETM5-20K-N	7 - 8
\$96.00	XJETM5-25K-N	8.5+



15 PC. PROPORTIONER TIP KIT

X-JET

- For providing 1:1 to 900:1 Ratios of water to chemical with the X-Jet Kits

\$15.44 XJET-PPK



ADJUSTABLE SPRAY NOZZLE

X-JET

\$29.25 XJET-M5RVN

REPLACEMENT FOR M5 KITS & DS TWIST NOZZLES



5 GALLON X-JET PAIL SYSTEM

X-JET

- Chemicals not included
- Specifically for use with the X-Jet system
- Prevents spills during use
- X-Jet hose, nozzle, and proportioner tips sold separately

\$36.77	XJET-PSA	X-Jet Pail System Assembly
\$19.58	XJET-PSS	Shaft only for X-Jet System



15' CHEMICAL HOSE

X-JET

- X-Jet hose assembly with viton shut off valve, tank screen, barb, and 15ft hose

\$37.50 XJET-HA



SPRAY ORIFICES

X-JET

Rated for 2000-4000 PSI

PRICE	KR #	GPM	#
\$15.45	XJET-OR7	2-2.5	7
\$15.45	XJET-OR9	3-3.5	9
\$15.45	XJET-OR13	4-4.5	13
\$15.45	XJET-OR16	5-6.5	16
\$15.45	XJET-OR20	7-8	20
\$15.45	XJET-OR25	8.5+	25

PRESSURE WASH



PRESSURE WASH CHEMICALS



PRESSURE WASHING CHEMICALS

SIMONIZ

NAME	5 GAL.	55 GAL.	DESCRIPTION	DILUTION
ALUM BRIGHT	PA5510*	DR55518*	A powerful blend of strong acids and surfactants made for cleaning of stained and maturated aluminum surfaces. This is an etching type of cleaner and is to be used for the periodic cleaning of aluminum trailer bodies and similar surfaces. It is not recommended for highly polished surfaces.	Heavy Loads - 1:10 Light Loads - 1:20
FORMULA 8000	PA5283	DR55508	An extra heavy-duty caustic liquid for heavy soil removal. One of the strongest liquid pressure and stream cleaning compounds. Special inhibitors allow it to be used to brighten certain aluminum surfaces.	General Purpose 1:60 Low Pressure 1:30
SUPER KLEEN	PA5287	DR55287	A concentrated, "oil splitting" formulation for pressure cleaning in a water reclamation environment. It contains a unique detergent system that allows oils to rapidly "split off" from the cleaning solution.	General 1:40 Heavy-duty 1:20
SC-100	BX5425 50 lb. Box	P01425 100 lb. Drum	A heavy-duty, non-caustic alkaline detergent that contains special inhibitors to stop rust. Removes carbon, heavy grease and oily soils. Ideal for cleaning aluminum motor blocks, heads, castings, crank shafts and similar objects. Does not contain chromium salt or chlorinated solvents.	2-4 oz per gallon
SC-100 WITH D-LIMONENE	BX5165 50 lb. Box	P01165 100 lb. Drum	A heavy duty, non-caustic alkaline detergent. Contains special inhibitors to stop rusting, removes carbon, heavy grease and oily soils. Ideal for cleaning aluminum motor blocks, heads, castings, crank shafts and similar objects. Does not contain chromium salts or chlorinated solvent. Contains naturally occurring d-limonene solvent for added cleaning and degreasing.	2-8 oz per gallon
SC-260	BX5430*	P01430* 100 lb. Drum	Our strongest spray cabinet stationary parts washer cleaner that removes oil, grease, carbon and sludge from motor blocks, engine parts, etc. It will strip paint and cannot be used on aluminum, magnesium or other highly polished metals.	2-8 oz per gallon
SHOP BOSS	PA5523	DR55523	Non-hazardous, non-butyl concentrated cleaner and degreaser for many different cleaning and degreasing operations.	Heavy Duty - 1:10 Medium Duty - 1:20 Light Duty - 1:64
SOLID GOLD	PA5512	DR55517	A highly concentrated degreaser blend of d-limonene solvent and non-ionic surfactants. It is the ideal way to remove grease and oil, adhesives and rubber tire marks from most chemically resistant surfaces, especially concrete floors. It also removes carpet and upholstery stains. Can be applied manually or through automatic scrubbers. This is a biodegradable solvent made from orange peels.	General - 1:50 Industrial - As is
TRUE	PA5501	DR55503	An all-purpose, free rinsing pressure wash liquid that gives outstanding results in cold water. It is ideal for cutting through film build up on trucks, equipment, mobile homes and in degreasing operations.	1:60
Z-100	PA5526	DR55526	A concentrated slightly caustic, butyl, heavy-duty degreaser and pressure wash detergent.	Heavy Duty - 1:20 Light Duty - 1:60
969	PA5515*	DR55515*	An extra heavy-duty caustic liquid for heavy soil removal from steel, concrete masonry and similar inert surfaces. It is the strongest of our liquid pressure and stream cleaning compounds.	2-4 oz/gallon 1:10 for soak cleaning

* HAZARDOUS MATERIAL

PRESSURE WASH

CHEMICAL & CHEMICAL FOAM INJECTORS

PRESSURE WASHING KITS

SIMONIZ



NAME	PART #	DESCRIPTION	DILUTION
BIG RIG KIT	PO1140	A heavy duty pressure washing detergent, slightly caustic and free rinsing. Kit contains (1) 5 gallon Big Rig Liquid, 40 lb. of Big Rig Powder. Both parts mixed together yield (1) 55 gallon of concentrated cleaner.	Medium Soil - 1:64 Light Soil - 1:128
B-1 KIT	PO1150*	A low foaming all-purpose butyl cleaner and degreaser. Kit contains (1) 5 gallon B-1 Liquid, 40 lb. B-1 Powder. Both parts mixed together yield (1) 55 gallon of concentrated cleaner.	Heavy Cleaning - 1:3-5 Light Cleaning - 1:40
C-1 KIT	PO1154	A heavy duty, slightly caustic non-butyl cleaner and degreaser. Kit contains (1) 5 gallon C-1 Liquid, 40 lb. C-1 Powder. Both parts mixed together yield (1) 55 gallon of concentrated cleaner.	As Is.
T-1 KIT	PO1158	A heavy-duty concentrated truck wash and general purpose pressure wash cleaner and degreaser. Kit contains 5 gallons of liquid and 26 lbs of powder. Both parts mixed together yield (1) 55 gallon of concentrated cleaner.	As Is
SUPERPOWER WASH KIT	PO1175*	30 pounds powder + 5 gallons liquid + water = 55 Gallons product. Very cost effective drum kit for touch free automatics. High sudsing, high pH detergent.	20-60:1

* HAZARDOUS MATERIAL

ALL PURPOSE CLEANERS

SIMONIZ



NAME	5 GAL.	55 GAL.	DESCRIPTION	DILUTION
BLUE BUTYL	PA5504	DR55504	A concentrated all-purpose butyl cleaner and degreaser for all types of equipment. Versatile enough to be used in a spray bottle for general cleaning and heavy-duty degreasing and cleaning through a pressure washer.	All Purpose - 1:30 Floors, Asphalt - 1:20 Alum., Marble - 1:10 Batteries, Concrete - 1:3
CRUSH PLUS	PA5247	DR55273	A concentrated all-purpose cleaner and degreaser based on d-limonene. It has equal cleaning properties to most petroleum-based solvents. Safer for employees to handle than petroleum based solvents.	Heavy Duty - 1:4 Carpet Spotting - 1:10 Medium Duty - 1:64 Light Duty - 1:128
PINE KLEEN	PA5548	DR55548	A mildly concentrated, low foaming pine-scented cleaner. Recommended for heavy duty soil removal, light degreasing and all-purpose cleaning.	Spot Cleaning - 1:1 Heavy Duty - 1:10 Medium - 1:25 General - 1:40
TRU BLUE LIQUID CLEANER	PA5549	DR55549	A non-butyl surfactant-based degreaser and all-purpose cleaner. Environmentally safe.	Heavy Duty - 1:20 Medium Duty - 1:30 Light - 1:50

SPECIALTY PRODUCTS

SIMONIZ



NAME	1 GAL.	5 GAL.	55 GAL.	DESCRIPTION	DILUTION
ASPHALT RELEASE	-	PA5502	-	A specially formulated detergent for use as a lubricant on asphalt slides and asphalt truckbeds. A modern day replacement for traditional solvent lubricants.	1:6 - (22 oz./gallon)



UNIVERSAL FOAM INJECTOR KIT

SUTTNER



- Durable injector allows for the injection of a single pressure washing chemical. The nozzle produces a thick foam for an easy and safe application of chemicals with greatly reduced splashing and drifting of chemicals.

INJECTOR SPECS:

- Stainless steel construction
- 3/8" inlet/outlet
- 5000 PSI

NOZZLE SPECS:

- 1/4" inlet
- 4000 PSI

PRICE	PART #	ORIFICE
\$146.34	SUT160751	2.0-3.5

PRICE	PART #	ORIFICE
\$146.34	SUT160752	4.0-5.5

PRICE	PART #	ORIFICE
\$146.34	SUT160753	6.5-7.0



LOW-PRESSURE CHEMICAL INJECTOR

BE PRESSURE



- PRESSURE:** 4000 PSI
- FLOW:** 2-5 GPM
- MAX TEMP:** 195°F
- PLUG OUTLET:** 3/8"

\$23.40 **PW85400000**



HIGH-PRESSURE UP STREAM SOAP INJECTOR

BE PRESSURE



- PRESSURE:** 3500 PSI
- FLOW:** 3-5 GPM
- Adjustable soap injector draws soap or chemical into your water spray stream
- Male garden hose x Female garden hose connection fits directly onto your pump inlet

\$41.26 **PW85400003**

HAZARDOUS MATERIAL. A \$36.00 FEE MAY BE ADDED TO YOUR ORDER.



1-800-233-3873 • (717) 684-6721 • FAX (800) 446-0495 • KLEENRITE.COM

615



STAINLESS STEEL MANIFOLD VALVES

303 STAINLESS STEEL BLOCK

- Stainless steel valves mounted on a 303 stainless steel manifold block. Common inlet port for chemical supply to all valves on both ends. Metering screw available on 1/4" NPT model.
- Buna N Seal • Pipe Size: 1/4" NPT • 1/8" Orifice • CV Flow Factor: 0.27

NON-METERING

DEMA STAINLESS STEEL MANIFOLD VALVES



PRICE	PART #	# STA	COIL/VOLTAGE
\$112.50	SODM2NMSS	2	24
\$108.42	SODM2NMSS120	2	120
\$166.60	SODM3NMSS	3	24
\$216.15	SODM4NMSS	4	24
\$216.15	SODM4NMSS120	4	120
\$272.09	SODM5NMSS	5	24
\$262.26	SODM5NMSS120	5	120



BRASS MANIFOLD VALVES

BRASS BLOCK

- Stainless steel valves mounted on a solid brass manifold block. Common inlet port for chemical supply to all valves on both ends. Metering screw available on 1/4" NPT model.
- Buna N Seal • Pipe Size: 1/4" NPT • 1/8" Orifice • CV Flow Factor: 0.27

NON-METERING

DEMA BRASS MANIFOLD VALVES



PRICE	PART #	# STA	COIL/VOLTAGE
\$81.74	SODM2NM	2	24
\$81.74	SODM2NM120	2	120
\$118.82	SODM3NM	3	24
\$114.53	SODM3NM120	3	120
\$157.15	SODM4NM	4	24
\$194.62	SODM5NM	5	24
\$187.58	SODM5NM120	5	120

WITH METERING

STAINLESS STEEL MANIFOLD VALVES



PRICE	PART #	# STA	COIL/VOLTAGE
\$132.14	SODM2MSS	2	24
\$101.27	SODM2MSS120	2	120
\$192.60	SODM3MSS	3	24
\$195.10	SODM3MSS120	3	120
\$265.59	SODM4MSS	4	24
\$265.59	SODM4MSS120	4	120
\$313.22	SODM5MSS	5	24
\$301.90	SODM5MSS120	5	120

\$33.93	SODK4918B	Repair Kit
---------	-----------	------------

METERING

DEMA BRASS MANIFOLD VALVES



PRICE	PART #	# STA	COIL/VOLTAGE
\$49.15	SODM1M	1	24
\$41.06	SODM1M120	1	120
\$90.85	SODM2M	2	24
\$69.62	SODM2M120	2	120
\$131.31	SODM3M	3	24
\$131.31	SODM3M120	3	120
\$173.47	SODM4M	4	24
\$214.78	SODM5M	5	24
\$214.78	SODM5M120	5	120

\$11.10	SODP419724	24V Coil
\$33.93	SODK4918B	Repair Kit



HIGH FLOW STAINLESS STEEL MANIFOLD VALVES

DEMA VALVES



- Available in three, four or five stations, can be combined for additional stations
- CV Flow Factor: 2.0 • 15.5 GPM at 60PSI • Viton Diaphragms • 1/2" NPT Inlet • 3/8" NPT Outlets

PRICE	PART #	STATIONS
\$207.81	SODM3MSS-HF	3 station
\$259.94	SODM4MSS-HF	4 station
\$326.68	SODM5MSS-HF	5 station



NON-METERING STAINLESS STEEL SINGLE STATION ROUND BODY VALVE

DEMA VALVES



- Buna N Seal • CV Flow Factor: 0.27 • Max Pressure: 150 PSI • Min Pressure: 0 PSI

PRICE	PART #	COIL/VOLTAGE	PIPE SIZE	ORIFICE
\$41.38	SOD492S24	Spade 24 vac	1/4" NPT	1/8"

DIAPHRAGM VALVES



NORMALLY CLOSED MINI DIAPHRAGM VALVES

DEMA STAINLESS STEEL DIAPHRAGM VALVES



- Molded water-resistant coil with spade connections
- EPDM diaphragm
- 15.5 GPM flow at 60 PSI
- Bracket and cover included
- 12.6 GPM flow at 40 PSI
- 303 investment cast stainless steel body
- Available in 24V or 120V
- 8.9 GPM flow at 20 PSI

VALVE W/O COVER & BRACKET		
\$62.02	SOD463SS24	3/8" NPT
\$62.02	SOD464SS24	1/2" NPT

VALVE W/ COVER & BRACKET		
\$65.40	SOD463SS24C	3/8" NPT
\$65.40	SOD464SS24C	1/2" NPT



IDEAL FOR WEEP SYSTEMS

NORMALLY OPEN MINI DIAPHRAGM VALVES

DEMA VALVES



PRICE	PART #	PIPE SIZE	VOLT	BODY	MAX PSI	ORIFICE
\$77.85	SOD0442P24	1/4"	24	Brass	125	1/4"
\$77.85	SOD0442P120	1/4"	120	Brass		1/4"
\$95.01	SOD0463PS24	3/8"	24	Stainless		3/8"
\$95.01	SOD0463PS120	3/8"	120	Stainless		3/8"
\$95.01	SOD0464PS24	1/2"	24	Stainless		1/2"
\$95.01	SOD0464PS120	1/2"	120	Stainless		1/2"



SOLENOID REPLACEMENT COILS

DEMA VALVES



PRICE	PART #	VOLT	COIL
\$17.22	SODP419D53	24VAC	DIN-Q-Coil
\$13.75	SODP41954	24VDC	Solenoid Valve
\$20.07	SODP419D54	24VDC	DIN-Q-Coil
\$22.45	SODP4191120	120V	Series 1
\$26.18	SODP419224	24VAC	Junction Box
\$11.97	SODP41956	120VAC	Solenoid Valve
\$22.45	SODP419124	24V	Series 1
\$26.18	SODP4192120	120V	Series 2

* COIL NUMBER IS FOUND ON FRONT STICKER



24" POWER CONNECTOR

DEMA



- Use with DIN solenoid valves

\$11.85 SODP417724

NORMALLY OPEN SOLENOIDS

DEMA VALVES



PRICE	PART #	DESCRIPTION	VOLT	PORTS	PSI	MATERIAL
\$92.31	SOD0412P24	N.O. Valve	24VAC	3/8"	150	Brass
\$92.31	SOD0412P120	N.O. Valve	120VAC	3/8"	150	Brass
\$123.00	SOD0453P24	N.O. Valve	24VAC	3/8"	1000	Brass
\$123.00	SOD0453P120	N.O. Valve	120VAC	3/8"	1000	Brass
\$95.01	SOD0463PS24	N.O. Diaphragm	24VAC	3/8"	125	Stainless
\$95.01	SOD0464PS24	N.O. Diaphragm	24VAC	1/2"	125	Stainless
\$112.84	SOD0474P120	N.O. Diaphragm	120VAC	1/2" NPT	-	Brass
\$112.84	SOD0474P24	N.O. Diaphragm	24VAC	1/2" NPT	150	Brass
\$112.84	SOD0473P24	N.O. Diaphragm	24VAC	3/8" NPT	150	Brass
\$112.84	SOD0473P120	N.O. Diaphragm	120VAC	3/8" NPT	150	Brass
\$119.34	SOD0476P24	N.O. Diaphragm	24VAC	3/4" NPT	150	Brass
\$119.34	SOD0476P120	N.O. Diaphragm	120VAC	3/4"	150	Brass



NORMALLY CLOSED DIAPHRAGM VALVES

DEMA DIAPHRAGM VALVES



- 303 investment cast stainless steel body
- 3/4" NPT, 3/4" Orifice
- 39 GPM @ 60 PSI

\$190.10 SOD476SS24 24V

\$190.10 SOD476SS120 120V

WANT TO LEARN MORE?

WATCH A **SOLENOID SERVICE VIDEO**
BY SIMPLY SCANNING THIS
QR CODE WITH YOUR PHONE





SOLENOID VALVES

DEMA SOLENOID VALVES



*Specify voltage (24 or 120)

- 90° valve, high flow
- Pressure 150 PSI
- Nylon Valve Body

PRICE	PART#	DEMA MODEL #	PIPE SIZE	ORIFICE
\$103.20	SOD466P	466P	3/4"	.750"



SOLENOID VALVES - BUNA-N DIAPHRAGM STANDARD

DEMA SOLENOID VALVES



*Specify voltage (24, 120 or 230)

- Pressure 150 PSI
- Valve Body Brass
- Buna-N Diaphragm Standard
- Teflon is available

PRICE	PART#	DEMA MODEL #	PIPE SIZE	ORIFICE	REPAIR KIT #
\$80.37	SOD473P	473P	3/8"	.562"	SODK4147
\$80.37	SOD474P	474P	1/2"	.562"	SODK4147
\$87.02	SOD476P	476P	3/4"	.750"	SODK4149



SOLENOID VALVES - NORMALLY CLOSED DIRECT ACTING DIAPHRAGM

DEMA SOLENOID VALVES



*Specify voltage (12, 24 or 120)

- Orifice .172"
- Direct Acting Diaphragm
- Adjustable
- PVC Valve Body
- Used on Vac Lines with Corrosive Liquid

PRICE	PART#	DEMA MODEL #	PIPE SIZE	ORIFICE
\$77.78	SOD481P	481P	1/8"	.172"
\$81.63	SOD482P	482P	1/4"	.172"



BRASS NORMALLY OPEN DIAPHRAGM STYLE

DEMA SOLENOID VALVES



*Specify voltage (24 or 120)

PRICE	PART#	DEMA MODEL #	PIPE SIZE	ORIFICE
\$112.84	SOD0473P	0473P	3/8"	9/16"
\$112.84	SOD0474P	0474P	1/2"	9/16"
\$119.34	SOD0476P	0476P	3/4"	3/4"



NORMALLY OPEN PLUNGER STYLE

DEMA SOLENOID VALVES



*Specify voltage (12, 24 or 120)

PRICE	PART#	DEMA MODEL #	PIPE SIZE	TYPE	PSI
\$92.31	SOD0412P	0412	3/8"	Brass	150
\$123.00	SOD0453P	0453	3/8"		1200

SOLENOID VALVES

SOLENOID VALVES

DEMA SOLENOID VALVES



*Specify voltage (24 or 120)

- Pressure 150 PSI
- Brass Valve Body



PRICE	PART#	DEMA MODEL #	PIPE SIZE	ORIFICE	DESCRIPTION (NORMALLY CLOSED TYPE)	REPAIR KIT #	
\$47.35	SOD401P	401P	1/4"	.109"	Direct Acting: Buna-n, Teflon, or Viton Seal	SODK4124	
\$63.07	SOD412P	412P	3/8"	.281"	Pilot Operated Piston	SODK4126	
\$48.00	SOD413P	413P	3/8"	.312"		SODK4127	
\$76.88	SOD414P	414P	1/2"	.438"		SODK4128	
\$104.58	SOD416P	416P	3/4"	.593"		SODK4129	
\$138.76	SOD418P	418P	1"	.760"		SODK4130	
\$8.70	SODK4124					Repair Kit (401P)	
\$13.23	SODK4126					Repair Kit (412P)	

SOLENOID VALVES

DEMA SOLENOID VALVES



*Specify voltage (24 or 120)

- Pressure 125 PSI
- Brass Valve Body



PRICE	PART#	DEMA MODEL #	PIPE SIZE	ORIFICE	DESCRIPTION (NORMALLY CLOSED TYPE)
\$51.59	SOD424SS	424P-2	1/4"	.125"	Direct Acting Corrosion Resistant, Available in Teflon or Viton
\$9.59	SODK4124V	41.24	Repair Kit		

SOLENOID VALVES

DEMA SOLENOID VALVES



*Specify voltage (12, 24 or 120)

- Pressure 125 PSI
- Diaphragm Type
- Built-in Strainer



PRICE	PART#	DEMA MODEL #	PIPE SIZE	ORIFICE	DESCRIPTION (NORMALLY CLOSED TYPE)
\$35.01	SOD442P	442P	1/4"	.250"	Diaphragm Type, Built-in Strainer
\$33.74	SOD443P	443P	3/8"	.250"	Diaphragm Type, Built-in Strainer

SOLENOID VALVES

DEMA SOLENOID VALVES



*Specify voltage (12, 24 or 120)

- Pressure 1200 PSI
- Brass Valve Body



PRICE	PART#	DEMA MODEL #	PIPE SIZE	ORIFICE	DESCRIPTION (NORMALLY CLOSED TYPE)	REPAIR KIT #
\$88.51	SOD453P	453P	3/8"	.350"	Pilot Operated Piston, High Pressure	SODK4131
\$98.22	SOD453SS	453S	3/8"	.350"	Pilot Operated Piston, High Pressure Stainless Steel Sleeve	SODK4131
\$133.36	SOD454P	454P	1/2"	.500"	Pilot Operated Piston, High Pressure	SODK4132
\$227.37	SOD458P	458P	1"	.937"	Pilot Operated Piston, High Pressure	SODK41332
\$245.65	SOD458PS	458PS	1"	.937"	Pilot Operated Piston, High Pressure Stainless Steel Sleeve	SODK4133



SOLENOID VALVES & MANIFOLD KITS

MANIFOLD BLOCKS

GC VALVES

- Brass Body with Viton Seals
- 24V
- Blocks can be ordered with or without metering screw
- Stainless Steel Orifice
- 1/4" FPT Port
- Max Pressure: 200 PSI
- Max Temp.: 230°F
- Orifice 3/32"
- Common inlet port for all valves

PRICE	PART #	METERING	OUTLETS
\$110.18	GC92	NONE	2
\$140.15	GC92M	YES	2
\$165.26	GC93	NONE	3
\$210.21	GC93M	YES	3
\$244.20	GC94	NONE	4

PRICE	PART #	METERING	OUTLETS
\$289.11	GC94M	YES	4
\$261.63	GC95	NONE	5
\$332.62	GC95M	YES	5
\$313.95	GC96	NONE	6
\$420.93	GC96M	YES	6

MANIFOLD BLOCKS

STAINLESS STEEL BODY / VITON SEALS

- Stainless steel body with Viton seals
- Max Pressure: 200 PSI
- Max Temp.: 230°F
- Common inlet port for all valves
- Orifice: 3/32"
- 24V
- 1/4" FPT Port
- Blocks can be ordered with or without metering screw

PRICE	PART #	METERING	OUTLETS
\$119.99	GCS92	NONE	2
\$151.85	GCS92M	YES	2
\$179.95	GCS93	NONE	3
\$220.10	GCS93M	YES	3
\$250.22	GCS94	NONE	4

PRICE	PART #	METERING	OUTLETS
\$303.67	GCS94M	YES	4
\$299.95	GCS95	NONE	5
\$379.59	GCS95M	YES	5
\$360.34	GCS96	NONE	6
\$455.52	GCS96M	YES	6

MANIFOLD KITS

G.C. VALVES

PRICE	PART #	MANIFOLD KITS
\$19.99	GCCM24	Coil for Manifold Blocks; 24V
\$17.68	GCK115	Plunger Only for Manifold Blocks
\$38.16	GCK21	Repair Kit, Manifold Blocks
\$56.04	GCK41	Repair Kit, Manifold Black Style
\$76.40	GCK621126	C6 Operator Kit Used on "Fragrance" line of car wash manifolds - DOES NOT INCLUDE Coil, top washer or top nut. INCLUDES: Tube, static seal o-ring, plunger with Kalrez seals and spring.

SOLENOID VALVES

GC VALVES

- Stainless Steel

PRICE	PART #	PIPE ORIFICE	PSI	VOLTAGE
\$124.64	GC140	1/4" 3/8"	1200	24
\$124.64	GC280	3/8" 3/8"	2200	24
\$141.56	GC340	1/2" 3/8"		24
\$124.64	GC281	3/8" 3/8"		120
\$141.56	GC341	1/2" 1/2"		120

LASERWASH G5 KIT

GC VALVES

- High performance, high flow
- Kit for Laserwash G5

\$199.95	GCK900
-----------------	---------------

SOLENOID VALVES W/ VITON SEALS

GC VALVES

- Brass or stainless steel body
- Viton seals
- Max Pressure: 200 PSI
- Orifice: 3/32"
- Max Temp: 230°F
- Choose 24 or 120V*

PRICE	PART #	BODY	PORT	METERING
\$30.16	GC091	Brass	1/8"	None
\$41.12	GC091SS	SS		None
\$49.59	GC095	SS		Yes
\$42.54	GC191	Brass	1/4"	None
\$71.33	GC191SS	SS		None
\$57.88	GC195	SS		Yes

*Add -120 to Part # for 120V

SOLENOID VALVES BRASS / NITRILE SEALS

GC VALVES

- Max Pressure: 150 PSI
- Max Temperature: 180°F
- Brass / Nitrile
- Choose 24 or 120V*

PRICE	PART #	PORT
\$75.95	GC391	1/2"
\$92.74	GC491	3/4"
\$113.71	GC591	1"

*Add -120 to Part # for 120V



SOLENOID VALVES & MANIFOLD KITS



SOLENOID VALVE KITS FOR C9 VALVES

GC VALVES

\$19.99	GCCM24	24V Coil
\$20.03	GCCM120	120V Coil
\$56.04	GCK41	Kit for 1/8" or 1/4"
\$43.64	GCK391	Kit for 1/2"
\$42.78	GCK491	Kit for 3/4"
\$51.93	GCK591	Kit for 1"



DIN CONNECTORS FOR C9 COILS

GC VALVES

• DIN connectors are available with cords up to 6'

\$6.90	GCP6010	Din Connector
\$6.64	GCP6010-AC	With LED
\$30.49	GCP6010-6	With 6' Cord
\$16.84	GCP6010-12L	1/2" Conduit with 36" Leads

SOLENOID VALVES

G.C. VALVES



GC315



GC0824B

PRICE	PART #	PORT	ORIFICE	VOLTAGE	PSI	GC MODEL #
\$61.33	GC100	1/4"	5/32"	120	150	S311AF02N3BD7
\$61.33	GC105	1/4"	5/32"	120	150	S311AF02V3BD7
\$61.33	GC110	1/4"	5/32"	24	150	S311AF01N3BD7
\$105.30	GC130	1/4"	3/32"	24	150	S306AF01V3BC9
\$93.56	GC210	3/8"	5/8"	24	0-140	S201AF01N5CG4
\$89.04	GC305	1/2"	5/8"	120	150	S211SF01N5DG4
\$96.37	GC300	1/2"	5/8"	120	150	S211SF02N5DG4
\$89.96	GC315	1/2"	5/8"	24	200	S211UF01N5DG4
\$132.04	GC0824B	1/2"	1/2"	24	250	S211AF01K4DG1
\$89.04	GC235	3/8"	5/8"	24	250	S211YF01N5CG4
\$89.82	GC205	3/8"	5/8"	120	5-200	S211SF01N5CG4
\$93.56	GC0824NC	1/2"	5/8"	120	150	S201SF01N5DG4
\$89.97	GC200	3/8"	3/8"	120	150	S211SF02N5CG4
\$93.56	GC211	3/8"	5/8"	120	0-140	S201AF02N5CG4
\$109.91	GC405	3/4"	3/4"	120	140	S201AF02N5EG5
\$157.95	GC500	1"	1"	120	0-100	S201F02N5FC9
\$89.04	GC213	3/8"	5/8"	120	4-200	S211AF02N5CG4
\$89.82	GC348	1/2"	5/8"	120	4-200	S211AF02N5DGF
\$68.99	GC030	1/8"	1/8"	120	260	S301AF02N8ADS



NORMALLY CLOSED STAINLESS STEEL & BRASS SOLENOID VALVE

G.C. VALVES

- 24 VAC
- 1" NPT
- Solenoid w/ Buna Seals

\$635.73 **GC512**



SOLENOID VALVES

NORMALLY OPEN, BRASS BODY, PILOTED DIAPHRAGM

PRICE	PART #	PORT	VOLT.	PSI	GC MODEL #
\$126.88	GC220	3/8"	24	150	S212SF01N5CG4
\$187.55	GC215	3/8"	120		S212SF02N5CG4
\$126.88	GC325	1/2"	24		S212SF01N5DG4
\$126.88	GC320	1/2"	120		S212SF02N5DG4

SOLENOID VALVES

G.C. VALVES STAINLESS STEEL

PRICE	PART #	PIPE	ORIFICE	VOLTAGE	PSI
\$54.95	GCS0224	1/8"	1/8"	24	0-155
\$72.08	GCS0424	1/4"	5/32"	24	0-150
\$218.45	GC350	1/2"	5/8"	24	4-200
\$218.45	GC355	1/2"	5/8"	120	4-200
\$218.45	GC270	3/8"	5/8"	24	4-200
\$218.45	GC275	3/8"	5/8"	120	4-200
\$223.53	GC450	3/4"	3/4"	24	4-200
\$223.53	GC455	3/4"	3/4"	120	4-200
\$618.73	GC506	1"	1"	120	5-150



NORMALLY CLOSED SOLENOID VALVE

G.C. VALVES

- 120 VAC
- Viton Seal
- Direct Acting

\$73.79 **GC112**



MANIFOLD BLOCKS

IMI NORGREN KIP FLUID CONTROL VALVE SERIES

- SS solenoid valve mounted on solid brass manifold block
- Blocks can be ordered with or without metering screw
- Common inlet 1/4" NPTF port for all valves

PRICE	PART #	VOLT.	METERING	OUTLETS	PRICE	PART #	VOLT.	METERING	OUTLETS
\$92.78	SK2X910V2	24	NONE	2	\$107.55	SK2X911VM2	24	YES	2
\$122.71	SK2X910V3			3	\$146.38	SK2X911VM3			3
\$155.87	SK2X910V4			4	\$185.20	SK2X911VM4			4
\$185.93	SK2X910V5			5	\$231.47	SK2X911VM5			5
\$211.13	SK2X910V6			6	\$257.78	SK2X911VM6			6

SOLENOID VALVES

IMI NORGREN KIP SERIES 3 FLUID CONTROL VALVE SERIES

- 24V 2-way normally closed
- Operating temperature: -4 to 104 °F
- Max pressure 150 PSI
- Ideal for liquid, air, or vacuum applications
- Buna seal
- Coil: dry tape wrapped with leads
- Stainless Steel

PRICE	PART #	PORT	CONNECTOR	ORIFICE
\$52.50	SKP351015	1/4" NPTF	1/4" NPT	1/8"
\$29.59	SK0242		Conduit Housing	
\$61.00	SKP351015-K		Repair Parts Kit	

SOLENOID VALVE REPAIR KITS

IMI NORGREN KIP FLUID CONTROL VALVE SERIES

PRICE	PART #	DESCRIPTION
\$9.91	SKPA38	KIP Plunger Assembly
\$23.04	SKRK15	KIP Repair Kit 1/8" Orifice
\$23.04	SKRK35	KIP Repair Kit 1/4" Normally Closed
\$23.04	SKRK39	KIP Repair Kit 3/32" Orifice
\$42.11	SKRV	KIP Manifold Style Replacement Valve 24V
\$23.04	SKRK910	Repair Kit for Kip Valves Manifold - Non-Metering
\$23.04	SKRK911	Repair Kit for Kip Valves Manifold - Metering

NON-LOCKING SOLENOIDS

V61/V62 Series: 3/2NC Non-Locking

PRICE	KR #	MFG #	DESCRIPTION	ACTUATION	PORT (NPT)	FLOW CV (l/MIN)	OPERATING PRESSURE
\$101.57	SK0400-120	V61R417A-A318JB	1/4" • 120VAC	Solenoid/Spring	1/4"	1.30 (1300)	44 - 145 PSI
\$98.89	SK0400-24DC	V61R417A-A313JB	1/4" • 24VDC		1/4"	1.30 (1300)	
\$152.04	SK0600-120	V62S417A-A318JB	3/8" • 120VAC		3/8"	2.60 (2600)	
\$152.04	SK0600-24DC	V62S417A-A313JB	3/8" • 24VDC		3/8"	2.60 (2600)	

V61/V62 Series: 5/2 Non-Locking

PRICE	KR #	MFG #	DESCRIPTION	ACTUATION	PORT (NPT)	FLOW CV (l/MIN)	OPERATING PRESSURE
\$100.19	SK0405-120	V61R517A-A318JB	1/4" • 120VAC	Solenoid/Spring	1/4"	1.30 (1300)	44 - 145 PSI
\$102.91	SK0405-24DC	V61R517A-A313JB	1/4" • 24VDC		1/4"	1.30 (1300)	
\$153.33	SK0605-120	V62S517A-A318JB	3/8" • 120VAC		3/8"	2.60 (2600)	
\$153.33	SK0605-24DC	V62S517A-A313JB	3/8" • 24VDC		3/8"	2.60 (2600)	
\$127.97	SK0410-120	V61R511A-A318JB	1/4" • 120VAC	Solenoid/Solenoid	1/4"	1.30 (1300)	44 - 145 PSI
\$181.14	SK0610-120	V62S511A-A318JB	3/8" • 120VAC		3/8"	2.60 (2600)	
\$181.14	SK0610-24DC	V62S511A-A313JB	3/8" • 24VDC		3/8"	2.60 (2600)	

V61/V62 Series: 5/3APB Non-Locking

PRICE	KR #	MFG #	DESCRIPTION	ACTUATION	PORT (NPT)	FLOW CV (l/MIN)	OPERATING PRESSURE
\$166.63	SK0415-120	V61R611A-A318JB	1/4" • 120VAC	Solenoid/Solenoid	1/4"	1.30 (1300)	44 - 145 PSI
\$166.63	SK0415-24DC	V61R611A-A313JB	1/4" • 24VDC		1/4"	1.30 (1300)	
\$219.80	SK0615-120	V62S611A-A318JB	3/8" • 120VAC		3/8"	2.60 (2600)	
\$219.80	SK0615-24DC	V62S611A-A313JB	3/8" • 24VDC		3/8"	2.60 (2600)	



SOLENOID VALVES

SOLENOID VALVES

IMI NORGREN KIP FLUID CONTROL VALVE SERIES



STANDARD VALVE WITH FLYING

SIDE METERING

NORMALLY OPEN

NON-METERING

BOTTOM METERING

- 24V 2-way normally closed
- Max operating pressure 150 PSI
- Viton seals used for long life
- Stainless Steel
- For soap, wax, tire cleaner, or presoak
- Available in 1/4" or 1/8" FPT
- Spade terminals for easy wiring

PRICE	PART #	PORT	VOLTAGE	METERING	ORIFICE
\$39.36	SKM02B	1/8" NPTF	24	BOTTOM	3/32
\$42.60	SKM02S	1/8" NPTF		SIDE	3/32
\$42.02	SKM04S	1/4" NPTF		SIDE	1/8
\$33.00	SKNM02	1/8" NPTF		NONE	1/8
\$36.28	SKNM04	1/4" NPTF		NONE	1/8
\$44.81	SKNO04	1/4" NPTF		NORMALLY OPEN	



SOP1200



SOP1202/04/06



SOP1208/12/14



SOP1216



SOP1210



SOP1218

SOLENOID VALVES

PARKER



- 18" lead wires
- Conduit coil
- NPT Pipe

PRICE	PART #	PIPE	VOLTAGE	PSI	BODY	DESCRIPTION
\$186.77	SOP1200	1"	120/60	150	Brass	Normally Closed
\$193.93	SOP1202-120	1/2"	120/60	150		Normally Open
\$187.30	SOP1202	1/2"	24/60	150		Normally Open
\$109.95	SOP1204-120	1/2"	120/60	150	Brass	Normally Closed
\$109.95	SOP1204	1/2"	24/60	150		
\$120.45	SOP1206-120	3/4"	120/60	150		
\$126.27	SOP1206	3/4"	24/60	150	Stainless	Normally Closed
\$117.04	SOP1208	1/8"	24/60	365		
\$72.12	SOP1210	1/4"	24/60	150	Brass	Normally Open
\$64.53	SOP1212-120	1/4"	120/60	145		
\$109.35	SOP1212	1/4"	24/60	145	Brass	Universal Operation
\$68.19	SOP1214	1/4"	24/60	120		
\$187.45	SOP1216	1/4"	24/60	130		
\$177.80	SOP1218	1/4"	24/60	100		



SOP1040



SOP1060



SOP1020

SKINNER SOLENOID VALVE

PARKER



PRICE	PART #	DESCRIPTION
\$159.58	SOP1040	7221GBN4VN00 Skinner Solenoid
\$235.25	SOP1060	71215SN2MV00A0J111B2 Skinner Solenoid
\$165.13	SOP1020	71335SN2KNJ1NOC111B2 Skinner Solenoid
\$165.13	SOP1000	71315SN2ENJ1NOC111P3 Skinner Solenoid
\$125.21	SOP1090	71215SN2MN00NOC111P3 Skinner Solenoid
\$92.74	SOPK320	SK000090 Seal Kit MG & MF

STEEL DIRECT OPERATED SOLENOID VALVE 1/4" NPT

SMC PNEUMATICS



SPECIFICATIONS:

- Function: Normally Closed
- Thread Type: N (NPT)
- Bracket: None
- Size: 2 (Series 20)
- Rated Voltage: 3 [120 (110) VAC]
- Orifice Diameter/Port Size: 302 (Orifice Diameter: ø3.2mm; Port Size: 1/4)
- Body Material: S (Stainless Steel)
- Seal Material: N (NBR)
- Electrical Entry: DS (DIN Terminal, w/Surge Voltage Suppressor)

FEATURES:

- Internal stopper reduces metal noise
- 360-degree coil rotation
- Stainless steel enclosure for superior resistance to both corrosion and water
- Coil technology maximizes magnetic efficiency and reduces energy consumption
- Standard stainless-steel body, IP67 protection rating
- UL, CE and NSF compliant



PRICE	KR #	SMC #	PORT	VOLTAGE	PRICE	KR #	SMC #	PORT	VOLTAGE
\$57.22	SMC600-24	JSX21-SN302N-BCS	1/4"	24 VAC	\$54.75	SMC600-120	JSX21-SN302N-3CS	1/4"	120 VAC
\$53.87	SMC600-24DIN	JSX21-SN302N-BDS		24 VAC DIN	\$56.67	SMC600-120DIN	JSX21-SN302N-3DS		120 VAC DIN

SOLENOID VALVES

ASCO® SOLENOID VALVES

- The solenoid is an electromagnetic part of a valve, comprised of a coil, coretube, core and enclosure. ASCO Red Hat brand solenoid valves are designed to handle the most demanding fluid control applications.

NORMALLY CLOSED LOW PRESSURE SOLENOID VALVES

ASCO RED HAT

- When no power is applied to the coil, the valve stays closed. Once power is applied the valve opens

PRICE	PART #	VOLT	PSI	PIPE	BODY
\$43.89	SA012	24	150	1/8"	Brass
\$77.95	SA016	24		1/8"	Stainless
\$63.61	SA100	120		1/4"	Brass
\$62.05	SA111	24		1/4"	
\$51.96	SA112	120		1/4"	
\$51.96	SA113	24		1/4"	

PRICE	PART #	VOLT	PSI	PIPE	BODY
\$86.91	SA160	110	150	1/4"	Stainless
\$86.91	SA161	24	150	1/4"	Stainless
\$121.84	SA200	120	150	1/2"	Brass
\$121.84	SA202	24	150	1/2"	
\$131.70	SA300	110	150	3/4"	
\$131.70	SA302	24	150	3/4"	

NORMALLY OPEN LOW PRESSURE SOLENOID VALVES

ASCO RED HAT

- When no power is applied to the coil, the valve stays open. Once power is applied the valve closes
- Most commonly used for weep systems

PRICE	PART #	VOLT	PSI	PIPE	BODY
\$95.85	SA170	120	90	1/4"	Brass
\$95.85	SA171	24	75	1/4"	
\$211.46	SA216	120	125	1/2"	

PRICE	PART #	VOLT	PSI	PIPE	BODY
\$211.46	SA218	24	125	1/2"	Brass
\$211.46	SA250	120		3/8"	
\$211.46	SA252	24		3/8"	

NORMALLY CLOSED 3-WAY SOLENOID VALVES

ASCO RED HAT

- These valves have three pipe connections and two orifices. When one orifice is open, the other is closed and vice versa.

PRICE	PART #	VOLT	PSI	PIPE	BODY
\$112.00	SA135	120	100	1/4"	Brass

PRICE	PART #	VOLT	PSI	PIPE	BODY
\$112.00	SA136	24	100	1/4"	Brass

ASCO "S" SERIES SOLENOID VALVES

ASCO RED HAT

- Available in Normally Closed and Normally Open constructions
- Available either AC or DC operated with brass bodies. They come standard with DIN connection coils.

NORMALLY CLOSED				
PRICE	PART #	SIZE	VOLTS	
\$67.99	SC100	3/8"	24	
\$67.99	SC125	3/8"	120	
\$67.99	SC200	1/2"	24	
\$67.99	SC225	1/2"	120	
\$98.39	SC300	3/4"	24	
\$98.39	SC325	3/4"	120	

NORMALLY OPEN				
PRICE	PART #	SIZE	VOLTS	
\$131.93	SC250	1/2"	24	
\$131.93	SC275	1/2"	120	
\$39.55	SC015	1/4"	24	
\$131.93	SC150	3/8"	24	
\$131.93	SC175	3/8"	120	

FEMALE DIN CONNECTORS

ASCO RED HAT

- ASCO's electrical connection devices are designed using the DIN 43650/ISO 4400 or DIN 46244 form standards consistent with their solenoid valve coil designs and permitting industry interchangeability. Each size is available for user wiring or factory prewired installations. Other options include 1/2" conduits, and LED/VDR models.
- Glass fiber reinforced polyamide housing and lid
- IP65 protection against moisture entry and washdown when properly installed with gaskets
- LED: Light Emitting Diode. A solid-state diode that emits light to indicate power to the connector
- VDR: Varistor absorbing the self-inductance of the coil. The VDR is there to protect the coil or controller against supply over-voltage or peak
- Maximum voltage 240V

PRICE	PART #	SIZE	ROTATABLE
\$45.38	SA290410001	18mm - 1/2" Conduit	90°
\$32.45	SA290413001	11mm - 1/2" Conduit	180°



SOLENOID VALVES



SOLENOID VALVES

DANFOSS VALVES



- Covers a wide range of direct-operated 2/2-way solenoid valves for universal use. A robust valve program with high performance and can be used in all kind of tough working conditions. The lifetime of the valve is significantly extended because of the specially shaped diaphragm that reduces the stress level of the rubber. This special shape also ensures optimal flow.

PRICE	PART #	SIZE	STYLE	VOLTS	PSI	DANFOSS #
\$72.90	DF032U758519	3/8"	Normally Closed	24	145	32U758519
\$79.65	DF032U758536	3/8"		120		32U758536
\$93.68	DF032U758619	1/2"		24		32U758619
\$99.36	DF032U6524	3/4"		120		032U6524

REPAIR KITS

SOLENOID VALVES



PRICE	PART #	SIZE	STYLE
\$32.80	DF032U1066	3/8"	Solenoid Repair Kit
\$34.27	DF032U1069	3/4"	
\$42.24	DF032U0166	3/8"	Armature Repair Kit
\$85.86	DF032U0167	1/2"	

DOLE DUAL INLET

SOLENOID VALVES

- 24V coil AC • 3/4" Male Garden Hose • 3/8" Female Pipe Thread



PRICE	PART #	DESCRIPTION
\$61.40	SOM1000	Dole Dual Inlet Valve
\$11.06	SOM2550	Dole Valves Repair Kit

ERIE 3-WAY SOLENOID VALVE

SOLENOID VALVES

- Erie's line of motorized hydronic valves, the PopTop, provides convenient, reliable, and easy installation for a variety of heating and cooling applications.
- The PopTop makes installation a snap with easy, one-handed removal or engagement of the actuator to the valve body.
- Brass forged 300 PSig rated body
- Meets or exceeds ANSI IV standard for close off
- Wide variety of Cv's for better control



PRICE	PART #	SIZE	VOLTAGE	PSI
\$113.58	S013000	1/2"	24	20
\$137.79	S013100	3/4"		13

REPLACEMENT MOTOR FOR BOTH VALVES

ERIE 3-WAY SOLENOID VALVE

\$55.76	S013000M
----------------	-----------------



SOLENOID VALVES

New!



VX222AZ1VB

VXZ262KJB

VXZ242FZ1VB

SOLENOID NORMALLY CLOSED 2 PORT VALVE

SMC PNEUMATICS



PRICE	PART #	SIZE	STYLE
\$40.65	VX222AZ1VB	1/4" FPT	24V AC
\$65.35	VXZ242FZ1VB	1/2" FPT	24V AC
\$65.11	VXZ242FJB	1/2" FPT	120V AC
\$92.24	VXZ262KJB	1" FPT	110V AC
\$92.24	VXZ262KZ1VB	1" FPT	24V AC

New!



SINGLE 800 SERIES SOLENOID VALVE

MAC VALVES



- Includes 6' yellow cord

PRICE	PART #	SIZE	VOLTAGE
\$104.52	MAC2426	1/4" FNPT	24V AC
\$101.28	MAC2515	1/4" FNPT	120V AC

MAC® SOLENOID

REPLACEMENT FOR POPULAR AUTOMATICS



- Unique patented MAC SOLENOID® valves for fastest possible response time with non burn-out feature on AC service
- **Balanced poppet pilot valve for high flow, precise repeatability and consistent operation**
- **Large spool or piston for maximum shifting forces even and minimum operation pressure**
- MAC spool and bore combination for wiping away contamination - eliminating sticking and for use on lubricated or non-lubricated service

PRICE	PART #	MFG PART#	DESCRIPTION	VOLTAGE
\$85.32	MAC2000	811C-PP-221CA-152AD	1/4" Mac Valve 800 Series	24 Volt
\$43.11	MAC2010	111B-221CABH	Solenoid For Laser Wash	24 Volt
\$65.37	MAC2060	225B-111CA	Solenoid 3 Way	110 Volt
\$65.38	MAC2090	225B-221CA	Solenoid 3 Way	24 Volt
\$94.26	MAC2170	811CPM224JA152	Solenoid with coil and base	24 Volt
\$93.34	MAC2150	811CPM114JA152	1/4" 120V Square DIN	120 Volt
\$48.95	MAC2040	113B-224JA	100 Series Mac Valve	24 Volt
\$48.95	MAC2020	113B-114JA	1/4" 3 Way Valve with DIN	120 Volt
\$46.46	MAC2030	113B-114JJ	1/4" Mac Valve 100 Series	120 Volt
\$46.46	MAC2050	113B-224JJ	1/4" Mac Square Din Connection Male	24 Volt
\$67.76	MAC2070	225B-111JA	1/4" 3 Way with Square DIN	110 Volt
\$72.61	MAC2080	225B-114JJ	1/4" With Square Din Connction Male	120 Volt
\$57.04	MAC2140	46A-LOO-JACOLR	Solenid for PDQ Touchless	24 Volt
\$73.95	MAC2180	912B-PM-221CAAB	1/4" Mac Valve for Laser Wash	24 Volt
\$29.19	MAC2100	35A-AAA-DACA1BA	1/8" Mac Valve for Ryko Dryer	24 Volt
\$34.78	MAC2110	35A-AAA-DACF1BA	1/8" W/96" Wire	24 Volt
\$45.49	MAC2120	45A-AA1-DACA1BA	1/8" 4-Port	24 Volt
\$57.04	MAC2130	46A-AA1-JACO1LR	1/8" No Leads	24 Volt
\$57.04	MAC2140	46A-LOO-JACOLR	Mac Valve for PDQ G5 Laserwash	-
\$88.78	MAC2160	811CPM114CA152	1/4" with Conduit 1/2"NPS	120 Volt
\$33.04	MAC2180-KIT	K09006	Repair Kit for 912BPM221	-



<https://www.macvalves.com/>

SAFETY & POP OFF VALVES

STAINLESS STEEL CHECK VALVE

SAFETY & POP OFF VALVES



- Inlet: 1/4" Female • Outlet: 1/4" Male
- Cracking Pressure: Less than 1 PSI
- Material: Stainless Steel
- Max. Pressure: 5000 PSI
- Max. Flow Rate: 4 GPM

\$25.65

CV0003

SAFETY RELIEF VALVE

J.E. ADAMS



- Designed for self-cleaning of circular area chamber and piston head
- Excess pressure vented out through discharge fitting, preventing damage to pump
- Adjustable set screw allows setting relief valve for discharge at your specific pressure
- Safety relief valves are tested but are not preset
- Stainless steel spring, brass construction
- 3/8" hose barb discharge fitting
- Max. temp.: 200°F • Max. Flow: 7 GPM

\$49.03

RE7415

1500 PSI

\$49.03

RE7416

2000 PSI

POP-OFF VALVE

FLUID CONTROLS

FLUID CONTROLS



- All models feature either machined brass or stainless steel construction
- All lower pressure models feature resilient valves, higher pressure valves offer stainless steel valve components as standard
- Atmospheric or hose barb relief ports • 1/4" to 1/2" NPTM inlet ports • Relief pressures from 750 to 6,500 PSI

PRICE	PART #	SIZE	GPM	PSI
\$9.55	RERV100	1/4"	3	1500
\$16.30	RERV500	3/8"	6	2000
\$20.68	RERV5001	3/8" with 1/4" Barb	6	2000

PRICE	PART #	SIZE	GPM	PSI
\$16.72	RERV500B	3/8"	6 GPM	3500
\$34.18	RERV600	3/8"	12 GPM	6500



THERMO VALVE

SAFETY & POP OFF VALVES



- Protects pumps from premature failure of seals, packing and cups by eliminating heat buildup in closed loop bypass systems.
- Valves open when temperature exceeds 145°F.
- Maximum pressure is 200PSI

\$13.86

TH0100

3/8"

\$13.86

TH0105

1/2"



POP-OFF VALVE

CAT PUMPS



PRICE	PART #	SIZE	PSI
\$33.13	PU30960	1/4"	300-1500
\$33.13	PU30961	1/4"	1000-3000
\$37.50	PU33960	3/8"	300-1500
\$37.50	PU33962	3/8"	1000-4000



POP-OFF VALVE

GIANT PUMPS



PRICE	PART #	SIZE	PSI
\$9.17	PU22530A	3/8"	1200
\$9.17	PU22550A	1/4"	1200
\$9.17	PU22531A	3/8"	2400
\$9.17	PU22560A	1/4"	2400
\$9.17	PU22532A	3/8"	3600
\$9.17	PU22565A	1/4"	3600
\$9.17	PU22533A	3/8"	5000
\$9.17	PU22568	1/4"	5000



BALL & METERING VALVES

LONG HANDLE BALL VALVE

BALL & METERING VALVES

- Yellow vinyl insulator on heavy duty plated carbon steel handles
- Suitable for full range of liquids and gases
- Fast 1/4 turn open or close operation
- Flow can go in both directions
- Solid chrome plated brass ball
- Pressure rated at 600 PSI
- Low operating torque

\$13.39	VL0031	1/4" F x F	\$18.23	VL0046	3/4" F x F
\$13.63	VL0036	3/8" F x F	\$22.44	VL0046MF	3/4" M x F
\$18.12	VL0041	1/2" F x F			



FULL PORT BALL VALVE

BALL & METERING VALVES

- 3/8"

\$10.15	VL0032
----------------	---------------



BALL VALVES ARE BUILT TO LAST.

These durable, simply designed valves boast a long operational life and act as an ideal shut-off mechanism. Don't forget, due to their design, ball valves can crack in the event of a freeze. Consider adding heat tape to your pipes!

METERING VALVE

BALL & METERING VALVES

- Precision calibrated dial to determine and allow a return to required flow settings
- Safe positive stop for needle travels
- One-piece forged housing
- Positive no-leak stem seal
- Nickel-plated available
- 1000 PSI maximum operating pressure
- Suitable for natural gas

\$8.53	VL0001	1/8" F x F	\$11.16	VL0006	1/4" F x F	\$10.90	VL0009	1/4" M x F
\$20.29	VL0002	1/8" M x M	\$9.37	VL0007	1/4" M x F			
\$7.61	VL0004	1/8" M x F	\$15.23	VL0008	1/4" M x M			



METERING VALVE

FLUID CONTROLS

- All adjusting knobs have oversize brass inserts with double setscrews to prevent loosening
- Valve bodies are either brass or stainless steel
- Panel mount or in-line styles, hose barb or threaded ports
- 1/4" F x F
- All adjusting shafts are stainless steel with double Viton o-ring seals
- All models have flow areas equal to a .140 diameter orifice
- Valves are in-line controls where flow is locked at a specific setting

\$22.52	VL0015
----------------	---------------



FLUID CONTROLS

BALL VALVE

VALLEY INDUSTRIES



- **PRESSURE RATING:** 200 PSI (CWP)
- **TEMPERATURE RATING:** -4°F to 250°F
- **BODY MATERIAL:** Chromed brass
- **BALL MATERIAL:** Chromed brass
- **STEM MATERIAL:** Chromed brass
- **SEAT MATERIAL:** Teflon®
- **SEAL MATERIAL:** Viton®

\$8.78	VL0023	1/4" F x F
\$8.78	VL0024	3/8" F x F
\$10.88	VL0025	1/2" F x F



SHORT HANDLE BALL VALVE

THE SPECIALTY MFG. CO.

THE SPECIALTY MFG. CO.
Custom to Our Specialty

- **MAXIMUM PRESSURE:** 500 PSI
- **MAXIMUM TEMPERATURE:** 180°F

\$5.44	VL0021	1/4" F x F
\$5.44	VL0022	1/4" M x F
\$15.19	VL0026	3/8" F x F
\$15.19	VL0027	3/8" M x F
\$15.67	VL0042	1/2" F x F



BALL VALVE

GENERAL PUMP®



- **MAXIMUM FLOW:** 12 GPM
- **MAXIMUM PRESSURE:** 5000 PSI
- Ideal for use in pressure washing applications!

\$43.24	VL0110	3/8" NPTF
\$65.16	VL0112	1/2" NPTF



METERING VALVE

THE SPECIALTY MFG. CO.

THE SPECIALTY MFG. CO.
Custom to Our Specialty

- **THROUGH HOLE DIAMETER:** .156"
- **SIZE:** 1/4" F x F
- **MAXIMUM TEMPERATURE:** 180°F
- **MAXIMUM PRESSURE:** 500 PSI
- With metering knob

\$28.86	VL0010
----------------	---------------



VALVES & FLOATS



FVR400 VALVE - MIP X MIP
BOB VALVES



- High capacity - heavy duty
- Adjusting arm tapped
- Buna-N disc standard
- Red brass body



PRICE	PART #	INLET	OUTLET	35 PSI	65 PSI	85 PSI
\$28.66	FVR400-6	3/8" MIP	3/8" MIP	9 GPM	11.5 GPM	13 GPM
\$30.06	FVR400-8	1/2" MIP	1/2" MIP	12 GPM	18 GPM	22 GPM
\$38.70	FVR400-12	3/4" MIP	3/4" MIP	21 GPM	32.5 GPM	39.9 GPM
\$60.90	FVR400-16	1" MIP	1" MIP	43.5 GPM	61 GPM	68.5 GPM

KIT FOR PART #	PLUNGER ASSEMBLY KIT	CUP & DISC KIT	ARM KIT	STEM	VITON CUP & DISC KIT
FVR400-6	FVRKB200	FVRKB100	FVRKB300	FVR450-10	FVRKB100V
FVR400-8	FVRKB210	FVRKB110	FVRKB300	FVR450-10	FVRKB110V
FVR400-12	FVRKB220	FVRKB120	FVRKB300	FVR450-10	FVRKB120V
FVR400-16	FVRKB230	FVRKB130	FVRKB300	FVR450-10	FVRKB130V



STEMS
BOB VALVES



PRICE	PART #	LENGTH	DESCRIPTION
\$6.18	FVR450-1-6	6"	1/4" - 20 SAE male connection - brass construction
\$7.71	FVR450-10		10" x 1/4"-20 brass float valve stem for FVR400-6; FVR400-8; FVR400-12; FVR400-16 and BOB CASA
\$15.96	FVR452-10		3/8" - 16 10~
\$19.16	FVR380		10" x 3/8"-16 brass float valve stem



COPPER FLOATS
BOB VALVES



- High capacity - heavy duty
- Red brass body

PRICE	PART #	DIA.	BUOYANCY IN LBS.	F SPUD CONNECTION
\$60.07	FVR440-3	3"	.34	1/4" - 20 SAE
\$48.79	FVR440-4	4"	.80	1/4" - 20 SAE
\$62.26	FVR440-5	5"	1.73	1/4" - 20 SAE
\$71.41	FVR440-6	6"	3.26	1/4" - 20 SAE
\$71.81	FVR441-6	6"	3.26	5/16" - 18
\$72.05	FVR442-6	6"	3.26	3/8" - 16 SAE
\$99.25	FVR440-7	7"	5.72	3/8" FIP
\$91.99	FVR441-7	7"	5.72	5/16" - 18 SAE
\$142.96	FVR440-8	8"	8.03	3/8" FIP



POLYPROPYLENE FLOATS
BOB VALVES



PRICE	PART #	DIA.	F SPUD CONNECTION	BUOYANCY IN OZS.
\$14.66	FVPF5	5"	1/4" - 20	34.7
\$17.30	FVPF6	6"	1/4" - 20	61
\$17.30	FVPF6-7	6"	5/16" - 18	61
\$20.25	FVPF8	8"	3/8" FIP	158

FVRC810 CASA VALVE
BOB VALVES



- For high heat
- Free Flow Outlet

PRICE	PART #	INLET	35 PSI	85 PSI
\$32.50	FVRC810-6	3/8" MIP	9 GPM	13 GPM
\$40.31	FVRC810-8	1/2" MIP	14 GPM	22.5 GPM
\$55.13	FVRC810-12	3/4" MIP	27 GPM	36 GPM
\$78.87	FVRC810-16	1" MIP	80 GPM	138 GPM

KIT FOR PART #	PLUNGER ASSEMBLY KIT	ARM KIT	STEM	VITON CUP & DISC KIT
FVRC810-6	FVRKB233	FVRKB333	FVR450-10	FVRKB133V
FVRC810-8	FVRKB233	FVRKB333	FVR450-10	FVRKB133V
FVRC810-12	FVRKB236V	FVRKB333	FVR450-10	FVRKB136V
FVRC810-16	FVRKB239V	FVRKB339	FVR450-10	FVRKB139V





FLOAT VALVES



TOPAZ INDUSTRI FLOAT VALVE

JOBE VALVES

- Topaz Industro Float Valves are designed to maintain water levels in applications requiring a valve with high mechanical strength and heat resistance, like industrial storage tanks and heated water cisterns
- Compact robust construction
- Made from corrosion-resistant materials
- Comes complete with float and arm
- Has a switch to lock valve in off position
- Has an internal filter to keep debris out of the valve
- Shuts down slowly to minimize water hammer
- Mounts horizontally or vertically
- Has port to connect to Frostpro anti-freeze device

- **WATER DIFFERENTIAL:** ¾" - 2 ½" increases as water inlet pressure increases
- **VALVE BODY:** Grivory
- **WHITE INTERNAL PARTS:** TE21 Acetal
- **FILTER:** PP/Nylon
- **DIAPHRAGM:** EPDM
- **VALVE SEAL:** Santoprene
- **SPRINGS, BOLTS, NUTS**
- **PIN, SCREW:** 304 Stainless Steel
- **O-RINGS:** Nitrile
- **FLOAT:** HDPE
- **FLOAT CORD:** Polyester
- **MAX OPERATING TEMP.:** 176°F
- **PRESSURE RATING:** 5-100 PSI
- **FLOW:** Up to 90 GPM

FOR HOT WATER

MOUNTS ABOVE OR BELOW WATER

\$229.13	JFVT12	¾" Valve
\$231.22	JFVT16	1" Valve

\$44.89	JFVTIK	Service Kit
----------------	---------------	-------------



TOPAZ FLOAT VALVE

- Shuts down slowly to minimize water hammer
- Has port to connect Frostpro anti-freeze device
- Comes complete with float and arm
- Has a switch to lock valve in off position
- Has an internal filter to keep debris out of the valve
- Float position easily adjustable without tools
- High flow
- Made from corrosion-resistant materials
- Mounts horizontally or vertically

- **WATER DIFFERENTIAL:** ¾" - 2 ½" increases as water inlet pressure increases
- **VALVE BODY & TAIL:** Glass filled nylon
- **WHITE/YELLOW INTERNAL PARTS:** Acetal
- **FILTER:** PP/Nylon
- **DIAPHRAGM:** EPDM
- **SEAL:** TPU
- **SPRINGS, BOLTS, NUTS**
- **PIN, SCREW:** 304 Stainless Steel
- **O-RINGS:** Nitrile
- **FLOAT:** HDPE
- **FLOAT CORD:** Polyester
- **MAX OPERATING TEMP.:** 140°F
- **PRESSURE RATING:** 5-100 PSI
- **FLOW:** Up to 90 GPM

MOUNTS ABOVE OR BELOW WATER

\$86.58	JFVTS12	¾" Valve
\$85.05	JFVTS16	1" Valve

\$86.23	JFVTS18	1¼" Valve
\$18.66	JFVSTK	Service Kit



TOPAZ DIFFERENTIAL VALVE

- Designed to allow the water level to drop to a set distance (2 inches - 9 feet) without electricity.
- Powered entirely by the water pressure/water level in the tank. It reduces the cycling wear and tear on the pump, and energy wasted when pumps turn off/on prematurely.
- Has a switch to lock valve in off position
- Has an internal filter to keep debris out of the valve
- **VALVE BODY:** Glass Filled Nylon
- **WHITE/YELLOW INTERNAL PARTS:** Acetal
- **FILTER:** PP/Nylon
- **DIAPHRAGM:** EPDM
- **SEAL:** Urethane
- **SPRINGS, BOLTS, NUTSPIN, SCREW:** 304 Stainless Steel
- **O-RINGS:** Nitrile
- **FLOAT:** HDPE
- **FLOAT CORD:** Polyester
- **ACTUATOR ARMS/CAPS:** ABS
- **MAX OPERATING TEMP.:** 140°F
- **PRESSURE RATING:** 15-150 PSI
- **FLOW:** Up to 90 GPM

MOUNTS ABOVE WATER

\$244.30	JFVD12	¾" Valve
\$246.36	JFVD16	1" Valve



TOPAZ VALVE OUTLET EXTENSION



- Detachable outlet extension is designed to fit over the existing outlet on your Topaz valve with detachable base. The outlet extension directs the flow into a narrow stream creating a less turbulent water flow. This product lengthens the outlet by 2"
- User can glue in a longer piece of 1" PVC pipe - extending the outlet as far as they like
- Extends outlet 2"
- Built-in air break non-siphon
- Fits Topaz valves with detachable base
- Converts oval outlets to round outlets
- **SCREWS:** Stainless steel (holds outlet in place)
- **MATERIAL:** PVC
- **MAX TEMP:** 140°F

NOT FOR USE WITH HOT WATER - DO NOT USE WITH TOPAZ INDUSTRI

\$10.11	JFVP50
----------------	---------------



FLOAT VALVES

VORTEX FLOAT VALVE

JOBE VALVES



- High flow
- Compact robust construction
- Mounts horizontally
- Corrosion-resistant materials
- Shuts down slowly to minimize water hammer
- Float position easily adjusts w/o tools
- Valve unscrews from tail for easy valve seal access
- Switch for locking in "off" position
- Has port to connect to Frostpro anti-freeze device

- **WATER LEVEL DIFFERENTIAL:** 3/4" - 2 1/2"
- **PRESSURE RATING:** 5-100 PSI
- **VALVE BODY:** GF Nylon
- **WHITE INTERNAL/EXTERNAL:** Acetal
- **ARM ASSEMBLY:** ABS
- **DIAPHRAGM:** EPDM
- **SEAL:** Urethane
- **METAL HARDWARE:** 304 Stainless Steel
- **O-RINGS:** Nitrile
- **FLOAT:** HDPE
- **MAX OPERATING TEMP.:** 140°F

MOUNTS ABOVE WATER

\$280.25	JFVV20	1 1/4" Valve
\$287.41	JFVV24	1 1/2" Valve
\$291.51	JFVV32	2" Valve

ROJO FLOAT VALVE

JOBE VALVES



- Mounts above or below water level
- May be placed on side, bottom, or top of water tanks and troughs
- Easy to service - just unscrew the parts!
- Fully adjustable float arm
- Made with corrosion-resistant materials
- Includes backnut and seal washer
- Built-in check valve
- Includes switch to lock valve in off position
- Flow automatically stops during servicing

- **PRESSURE RATING:** 0-150 PSI max
- **VALVE BODY:** ABS
- **YELLOW PARTS/FILTER:** Acetal
- **FLOAT:** HDPE
- **TAIL & NUT ARM, EXTENSION ARMS INTERNAL BLACK MOLDINGS:** Glass filled nylon
- **SEAL WASHER:** LDPE
- **METAL HARDWARE:** 304 Stainless Steel
- **O-RINGS:** Nitrile
- **MAX OPERATING TEMP.:** 140°F

MOUNTS ABOVE OR BELOW WATER

\$32.85	JFVR08	1/2" Valve
\$33.88	JFVR12	3/4" Valve



ROJO COMPACT FLOAT VALVE

JOBE VALVES



- Fits in compact spaces
- Float no wider than valve
- Multiple mounting positions - side, bottom, and top
- Fully adjustable float
- Non-corrosive material
- Lead-free
- Flow stops when unscrewed
- Valve body screws apart by hand for easy servicing
- Flow stops when unscrewed for servicing
- Supplied with backnut and seal washer
- Built-in check valve
- Fully adjustable float angle

- **PRESSURE RATING:** 0-150 PSI max
- **VALVE BODY TAIL & NUT:** ABS
- **YELLOW PARTS/FILTER:** Acetal
- **FLOAT:** HDPE
- **ARM EXTENSION ARMS INTERNAL BLACK MOULDINGS:** Glass Filled nylon
- **SEAL WASHER:** LDPE
- **METAL HARDWARE:** 304 Stainless Steel
- **O RINGS:** Nitrile
- **HIGH FLOW SEAL:** Urethane
- **FLOAT CORD:** Polyester
- **MAX OPERATING TEMP.:** 140°F

MOUNTS ABOVE WATER

\$34.91	JFVR08-C	1/2" Valve
\$35.42	JFVR12-C	3/4" Valve

FLOAT VALVES



**S4-100 STAGE 4
FLOAT VALVE WITH BACK UP**
CLEVELAND



- Features a smooth positive shutoff with redundant backup
- 2-in-1! If primary valve fails, the backup takes over
- Provides no more flooded pump rooms or high water/sewer bills
- **DIMENSIONS:** 9" x 14 1/2" x 6 1/4"
- **PRESSURE RANGE:** 5-110 PSI
- **PORT:** 1" FPT inlet/outlet

\$84.27 **FVC16-4** Stage 4 - 1" Float Valve with Redundant Back Up



**S3-100 STAGE 3 VERTICAL
FLOAT VALVE WITH PILOT**
CLEVELAND



- Designed for use in high turbulent tank conditions requiring 3/4" water level change before activations
- **DIMENSIONS:** 9" x 9" x 3 1/4"
- **PRESSURE RANGE:** 5-110 PSI
- **PORT:** 1" FPT inlet/outlet

\$47.99 **FVC16-3** Stage 3 - 1" Vertical Float Valve w/Blue & White Pilot



**S2-100P STAGE 2
FLOAT VALVE WITH PILOT**
CLEVELAND



- Operates independent of the main valve for reduced wear and extended functional life
- A 2 1/2" float is all that is required to shut off the 1 1/2" valve
- 1- piece urethane diaphragm
- 1/2" red plastic pilot valve
- 1" FPT inlet and outlet pipe size
- 4" float diameter
- **PRESSURE RANGE:** 5-110 PSI
- **FLOW:** Up to 250 GPM @ 60 PSI

\$42.53 **FVC16** Stage 2 - 1" Float Valve with Pilot
\$76.52 **FVC24** Stage 2 - 1 1/2" Float Valve with Pilot



**100 SERIES:
FLOAT VALVE DIAPHRAGM**
CLEVELAND

\$8.75 **FVC71D**

FLOAT VALVE WALTERS



- "Lo Valve" kicks in when a small amount of water is needed. When valve completely opens, the "Main Valve" is activated. Designed for car & truck washing.
- Features two interacting valves • **RATED TO 140°F**

VALVES			
PRICE	PART #	DESCRIPTION	GPM
\$41.25	FVW08	1/2" with float	13 GPM @ 80 PSI
\$43.20	FVW12	3/4" with float	21 GPM @ 80 PSI
\$70.63	FVW16	1" with float	100 GPM @ 80 PSI

PARTS		
PRICE	PART #	DESCRIPTION
\$19.10	FVWP150	Pilot Valve Assembly
\$13.13	FVWP16D	Diaphragm for 1"
\$0.30	FVWP17	Conical Spring 1/2" - 3/4"
\$0.40	FVWP18	Conical Spring 1"
\$9.92	FVWP812D	Diaphragm for 1/2" - 3/4"

FLOAT VALVES & PREVENTERS



HUDSON HIGH TEMPERATURE FLOAT



- The unique patented design of the Hudson Valve uses fluid pressure, as opposed to a lever arm and ball, as the force to close the valve. This compact, self-contained design greatly enhances the valve's reliability. The valve body is made of durable glass-filled nylon 6/6. Internal parts are of ABS plastic, silicone, and stainless steel. When properly installed, the valve will meet anti-siphon requirements.

\$31.81	FVH08	1/2" Valve	\$9.27	FVHP01	Valve Cap for 1" Valve
\$31.81	FVH16	1" Valve	\$2.44	FVHP03	Retainer Ring
\$16.14	FVHK4HT	Repair Kit for FVH16	\$6.47	FVHP05	Control Diaphragm for 1" Valve
\$16.14	FVHK4HTS	Repair Kit for FVH08	\$15.21	FVHP06	Valve Body (New Style)
\$2.60	FVHP09N	Filter for 1" Valve	\$7.63	FVHP07	Float Body for 1" Valve



FLOAT VALVE SUTTNER



- Brass 1/2" valve with plastic float
- Float rod is 6 1/2" long
- Inlet port is 1/2" FPT
- 175°F. max. temperature
- Max. flow 5 GPM

\$23.40 SUTFV8



FLOAT VALVES WATTS



\$143.16	FVW1000	1" Float Valve
\$40.13	FVW500	1/2" Float Valve
\$89.32	FVW750	3/4" Float Valve



COMPLETE PLUNGER ASSEMBLIES



\$25.60	FVWP186	1/2" Assembly
\$35.17	FVWP187	3/4" Assembly
\$42.70	FVWP188	1" Assembly



175 PSI BACKFLOW PREVENTER WATTS



- Prevent reverse flow of polluted water from entering into potable water supply due to backsiphonage and/or backpressure
- Now Lead Free! Bronze body construction, bronze ball valve shutoffs, and bronze test cocks
- Air-in/water-out design principle for protection during emergency combined backsiphonage and backpressure conditions

\$403.03	WBF009QT12	3/4" Without Strainer	\$1,757.46	WBF909QT12	3/4" Without Strainer
\$378.95	WBF009QT16	1" Without Strainer	\$3,864.14	WBF909QTS32	2" With Strainer
\$450.91	WBF009QTS12	3/4" With Strainer	\$3,434.06	WBF909QTS24	1 1/2" With Strainer
\$534.69	WBF009QTS16	1" With Strainer	\$2,476.10	WBF909QTS16	1" With Strainer
\$2,093.41	WBF909QT16	1" Without Strainer	\$2,113.06	WBF909QTS12	3/4" With Strainer
			\$326.70	WBF909K	Repair Kit

NOW LEAD FREE!



MAXI FLOW KLEEN-RITE CORP.



- Designed for operations with minimal restriction
- Positive check. No leaks. Pressure drop is insignificant.
- Stainless steel poppet and spring
- Less than 1 PSI cracking pressure
- Temperature rating to 200°F
- Viton seal
- Completely repairable
- Flow Rate: 4 GPM

PRICE	PART #	PRESSURE	SIZE
\$18.22	CV0006	5000 PSI	1/4" F x F SS HP
\$5.35	CV0006K	2000 PSI	1/4", 3/8" Repair Kit
\$14.39	CV0009	3000 PSI	1/4" F x F Brass
\$15.34	CV0039	3000 PSI	3/8" F x F Brass



<https://www.watts.com/products/plumbing-flow-control-solutions/backflow-preventers>

CHECK VALVES



POLYPROPYLENE CHECK VALVES

THE SPECIALTY MFG. CO.

THE SPECIALTY MFG. CO.
Custom to Our Specialty

PRICE	PART #	SIZE	MAX PSI/ OPENING PSI
\$9.53	CV0072	1/2" F x F	125 PSI / 1-3 PSI
\$10.83	CV0073	3/4" F x F	125 PSI / 1-3 PSI

PRICE	PART #	SIZE	MAX PSI/ OPENING PSI
\$8.94	CV0074	3/8" F x F	125 PSI / 1-3 PSI
\$8.48	CV0082	1/4" F x F	125 PSI / 1-3 PSI



BRASS CHECK VALVE

THE SPECIALTY MFG. CO.

THE SPECIALTY MFG. CO.
Custom to Our Specialty

- All brass body • Stainless steel spring • Buna seal O-ring poppet seal for bubble-tight operation • Repair kit not available

PRICE	PART #	SIZE	MAX PSI/ OPENING PSI
\$8.82	CV0035	1/4" F x F	1200 PSI/ 3 PSI
\$10.63	CV0040	3/8" F x F	1200 PSI/ 3 PSI
\$13.43	CV0045	1/2" F x F	1200 PSI/ 3 PSI



PVC HOSE BARBS

THE SPECIALTY MFG. CO.

THE SPECIALTY MFG. CO.
Custom to Our Specialty

PRICE	PART #	SIZE	MAX PSI/ OPENING PSI
\$6.49	CV0061	1/4" M x M	125 PSI/ 1 - 3 PSI
\$8.58	CV0063	1/4" Barb x 3/8" Barb	125 PSI/ 1 - 3 PSI
\$6.49	CV0064	1/4" M x 1/4" Barb	125 PSI/ 1 - 3 PSI
\$6.49	CV0065	1/4" Check Valve	125 PSI/ 1 - 3 PSI
\$6.49	CV0066	3/8" Check Valve	125 PSI/ 1 - 3 PSI

PRICE	PART #	SIZE	MAX PSI/ OPENING PSI
\$6.49	CV0067	1/2" Check Valve	125 PSI/ 1 - 3 PSI
\$6.49	CV0068	1/2" x 3/8" Check Valve	125 PSI/ 1 - 3 PSI
\$6.49	CV0069	1/4" F x F	125 PSI/ 1 - 3 PSI
\$6.49	CV0070	1/4" F x M	125 PSI/ 1 - 3 PSI



LOW PRESSURE CHECK VALVE

KLEEN-RITE CORP.

KLEEN-RITE CORP.

- Stainless steel construction • Maximum Pressure 2000 PSI • Opening pressure less than 1 PSI
- Maximum flow rate 4 GPM • Maximum Temperature 200°F • Standard with EPR seal for chemical resistance

\$16.69	CV0004	1/4" M x M	\$5.35	CV0006K	Repair Kit
----------------	---------------	------------	---------------	----------------	------------



LOW PRESSURE CHECK VALVE

KLEEN-RITE CORP.

KLEEN-RITE CORP.



CHECK VALVE

VALUE LINE

VALUE LINE

- Use in tank and inlet applications

- 1/4" F x F • 1200 PSI

\$19.95	CVK08L	Brass	1/2" F x F 2 1/2" L
\$29.66	CVK12L	Brass	3/4" F x F 2 7/8" L
\$57.26	CVK12SS	Stainless	3/4" F x F

\$15.10	CVV04	Brass
\$30.10	CVV04SS	Stainless Steel



BRASS CHECK VALVES

KLEEN-RITE CORP.

KLEEN-RITE CORP.

- Low Cracking Pressure • Bubble Tight

PRICE	PART #	PRESSURE	SIZE
\$47.86	CVB410	2000 PSI	1/4" F
\$47.07	CVB610	2000 PSI	3/8" F
\$2.19	CVS410K	Repair Kit	1/4" 3/8"
\$7.85	CVS410P	Poppet for	1/4" 3/8"

PRICE	PART #	PRESSURE	SIZE
\$5.56	CVS410SP	2000 PSI	Spring for 1/4", 3/8"
\$60.24	CVB810		1/2" Brass
\$121.43	CVB812		3/4" Brass



STAINLESS STEEL CHECK VALVES

KLEEN-RITE CORP.

TOP SELLER!

KLEEN-RITE CORP.

- Low Cracking Pressure • Bubble Tight

PRICE	PART #	PRESSURE	SIZE
\$58.90	CVS410	2000 PSI	1/4" F x F
\$2.19	CVS410K	Repair Kit	1/4" 3/8"
\$7.85	CVS410P	Poppet for	1/4" 3/8"

PRICE	PART #	PRESSURE	SIZE
\$63.55	CVS610	2000 PSI	3/8" F
\$5.56	CVS410SP		Spring for 1/4", 3/8"

CHECK VALVES



HIGH PRESSURE CHECK VALVES

THE SPECIALTY MFG. CO.

THE SPECIALTY MFG. CO.
Custom to Your Specialty

- Maximum - 3000 PSI

\$17.60	CV0031	3/8" F x F
\$18.25	CV0030	1/4" F x F



BRASS BALL CHECK VALVE

THE SPECIALTY MFG. CO.

THE SPECIALTY MFG. CO.
Custom to Your Specialty

- With stainless steel ball & seat
- Will not seal under low pressure
- Repair kit not available
- 2500 PSI

\$7.69	CV0038	1/4" M x M
\$7.30	CV0037	1/4" M x F



1/4" M x M BRASS CHECK VALVE

CVT



- 0-800 PSI
- Low Cracking Pressure
- Brass
- Viton O-ring

\$31.16	CVC2232
----------------	----------------



3/4" F x F BRASS CHECK VALVE

PARKER



- Use in automatic applications
- High pressure

\$866.92	CV0085
-----------------	---------------



1/4" M x M BRASS CHECK VALVE

U.S. PARA PLATE



- 0-2000 PSI
- Brass
- Viton O-ring
- Low cracking pressure of 2-5 PSI

\$15.97	CV0010
----------------	---------------



BLUE FOOT VALVE

FOOT VALVES

- For All HydroMinder Models: 506, 511, 5111, 515, 561, 562, 525, & 530
- Blue, Viton - for use with whitewalls, butyl and alkali
- Corrosion-resistant plastic and rubber last longer
- Step-down hose barb 1/4"-3/8"-1/2"

\$13.12	IN250020	Single
\$125.37	IN250020-10	10 Pack



GRAY FOOT VALVE

FOOT VALVES

- For soap & wax (EPDM Seal)
- Polypropylene
- 1/4", 3/8" and 1/2" barbs
- HydroMinder replacement part

\$9.62	IN250100	Single
\$91.85	IN250100-10	10 Pack



1/4" FOOT VALVE WITH CHECK STRAINER

DEMA



- Step-down hose barb allows for use of the following tube sizes (outer diameter): 1/4", 3/8", 1/2"
- Poly body with stainless steel ball and EP O-ring

\$3.66	INDP10011P
---------------	-------------------



FOOT CHECK VALVE

FOOT VALVES

- 1/4" Brass

\$4.62	INFBS4
---------------	---------------



FOOT VALVE STRAINER

FOOT VALVES

- 1/4" 60 Mesh

\$7.46	INHBS00
---------------	----------------



STAINLESS STEEL STRAINER

DEMA



\$5.57	INDP10011	1/4"
\$7.21	INDP3610	3/8"



1/2" PVC BARBED CHECK VALVE

THE SPECIALTY MFG. CO. **THE SPECIALTY MFG. CO.**
Custom to Your Specialty

- With stainless steel strainer

\$6.49	CV0067	Check Valve
\$3.99	IN010	Strainer



1/2" PVC BARBED INLINE CHECK VALVE

FOOT VALVES

- Viton

\$11.58	IN10076303
----------------	-------------------



1/2" PVC BARBED INLINE CHECK VALVE

FOOT VALVES

- EPDM

\$8.82	IN10076304
---------------	-------------------

CHECK VALVES



3/4" F X F STAINLESS STEEL CHECK VALVE

- Use in high-pressure automatic applications

\$41.20 CV0080



1/2" F X F STAINLESS STEEL CHECK VALVE

- Use in high-pressure automatic applications

\$47.90 CV0075



BRASS HIGH PRESSURE CHECK VALVE

PARKER



- Brass construction
- 8 GPM
- Maximum 2000 PSI
- Repair kit not available

\$23.52	CV0005	1/8" F x F	3 GPM
\$23.49	CV0036	1/4" F x F	5 GPM
\$47.09	CV0043	3/8" F x F	8 GPM
\$67.43	CV0048	3/4" F x F	25 GPM



HIGH PRESSURE BRASS CHECK VALVES

U.S. PARA PLATE



- High reliability
- Low opening pressure
- Easy to maintain
- 0 - 3000 PSI
- 1/4" F x F

\$44.09 CV0008



INLINE CHEMICAL CHECK VALVE

THE SPECIALTY MFG. CO.

THE SPECIALTY MFG. CO.
Custom In Our Specialty

- Black/clear PVDF body and Viton seals
- 1/4" barb diaphragm connections
- Max Pressure: 125 PSI
- Max Temperature: 150°F

\$3.03	CV0100-04	1/4"
\$3.03	CV0100-06	3/8"



HIGH PRESSURE CHECK VALVES

U.S. PARA PLATE



- For protection against reverse flow
- Allows free-flow in one direction. Seat design protects O-ring seal from contamination or flow damage
- Install in any position
- Temp. range -20° to +400°F. Opens at 3 to 5 PSI
- Viton seal with stainless steel spring
- Handles water, oil and many other fluids

\$45.69	CV0011	1/4" F x F Brass	\$92.99	CV0022	1/2" F x F HP Brass
\$60.96	CV0011SS	1/4" F x F Stainless Steel	\$6.00	CV0022K	1/2" F x F Repair Kit
\$4.67	CV0011K	1/4" F and 3/8" F Repair Kit	\$151.20	CV0051	3/4" F x F Brass
\$51.56	CV0015	3/8" F x F Brass	\$7.75	CV0051K	3/4" F x F Repair Kit



CHECK VALVE

FLUID CONTROLS

FLUID CONTROLS

- Constructed of stainless steel, with a Viton O-ring for leak-proof operation
- Valves are completely rebuildable
- Maximum of 3500 PSI
- Specifically designed for all car wash chemicals

\$19.45	CV0013	1/4" F x F Viton SS HP	\$8.87	CV0041TK	3/8" Teflon Repair Kit
\$7.91	CV0013K	1/4" SS Repair Kit	\$31.78	CV0071	1/2" F x F SS
\$19.60	CV0013T	1/4" F x F Teflon HP	\$32.64	CV0071T	1/2" F x F SS w/ Teflon seat
\$8.14	CV0013TK	1/4" Teflon Repair Kit	\$8.87	CV0071TK	1/2" Teflon Repair Kit
\$25.21	CV0041	3/8" F x F SS	\$41.20	CV0080	3/4" F x F SS Viton
\$8.72	CV0041K	3/8" F x F SS Repair Kit	\$44.43	CV0080T	3/4" F x F SS Teflon
\$25.35	CV0041T	3/8" Teflon SS HP	\$14.59	CV0080TK	3/4" Teflon Repair Kit

SWIVELS



STRAIGHT SWIVEL

SWIVELS BY J.E. ADAMS



KLEEN-RITE CORP.
YOUR RELIABLE SUPPLIER FOR THE CAR WASH INDUSTRY

- Stainless steel insert
- Repairable
- Swivels under pressure
- 200°F Temp. rating

PRICE	PART#	SIZE	PSI	PRICE	PART#	SIZE	PSI
\$13.30	SW7045	3/8F x F Brass	3000	\$20.39	SW7470	1/4M x F SS HP	5000
\$12.75	SW7070	3/8M x 1/4 F Brass	3000	\$17.25	SW7044	3/8M x F SS	5000
\$12.79	SW7080	3/8M x F Brass	3000				
\$13.08	SW7480	1/4M x F Brass	3000				

STRAIGHT SWIVEL REPAIR KITS

SWIVELS

PRICE	PART#	DESCRIPTION	PRICE	PART#	DESCRIPTION
\$8.52	SW7080K	Repair kit - SW7044/7080	\$4.72	SW7480K	Repair kit - 7480/7470/7070

BALL BEARING SWIVEL

FLUID CONTROLS

FLUID CONTROLS



- High-pressure swivel with brass body & stainless steel thrust bearings. Internally lubricated O-rings & SS center spool piece
- Max. Temperature: 160°F
- An economical choice for high-pressure wash applications. Built to last for reliable service
- Helps facilitate trouble-free operation at your wash



PRICE	PART#	SIZE	PSI	PRICE	PART#	SIZE	PSI
\$18.91	SW0140	1/4" F x M Brass	2000	\$21.75	SW0265	3/8" F x M Brass	3500
\$21.29	SW0145	1/4" M x F Brass	3500	\$36.42	SW0270	3/8" F x F Ball Bearing	3500
\$17.44	SW0260	3/8" F x M Brass	2000				



BALL BEARING SWIVEL REPAIR KITS

FLUID CONTROLS

PRICE	PART#	DESCRIPTION
\$7.46	SW0260K	Repair Kit 1/4" & 3/8"

These swivels from Fluid Controls are field repairable in minutes with the repair kit listed here. Avoid downtime by keeping repair kits on hand!

Buy our 5 pack of the best-selling **SW0260** in bulk and save!



2000 PSI BRASS SWIVEL

KLEEN-RITE KITS

- Kit contains: (5) 3/8" M x F brass swivels

\$86.49 **SW0260-5**

1000 PSI BRASS SWIVEL

KLEEN-RITE KITS

- Kit contains: (5) 3/8" M x F brass swivels

\$21.31 **SW0250-5**

ECONOMY LOW PRESSURE SWIVEL

BRASS SWIVEL

- 1000 PSI
- Non-Repairable

PRICE	PART#	SIZE
\$4.46	SW0250	3/8" M x 3/8" F
\$11.95	SW0255	3/8" M x 1/4" F
\$14.28	SW0258	1/2" M x 1/2" F



ECONOMY LOW PRESSURE SWIVEL

KLEEN-RITE CORP.

KLEEN-RITE CORP.
YOUR RELIABLE SUPPLIER FOR THE CAR WASH INDUSTRY

- 1000 PSI | 3/8" M x F

\$6.13 **SWE100**

BRASS HOSE REEL SWIVEL

J.E. ADAMS



- 3000 PSI | 10 GPM | 1/2" FPT | 300°F

\$42.81	SW7475	Swivel
\$12.15	SW7475K	Repair Kit



SELF-SERVE SWIVELS



BREAK-AWAY SWIVEL

SPRAYING SYSTEMS CO.



- They will prolong hose life by preventing kinking of hose as well as reducing operator fatigue
- Recommended for intermittent, non-continuous swivel requirements
- Flow is bi-directional • Max. temperature is 180° F • Brass construction • Provides leakproof connections

\$15.05	SW0205	3/8" F x F Brass	\$11.32	SW0100	1/4" F x M Brass
\$5.71	SW0205K	Repair Kit 3/8"	\$11.32	SW0105	1/4" F x F Brass
\$24.09	SW0300	1/2" F x M Brass	\$5.82	SW0105K	Repair Kit 1/4"
\$24.09	SW0305	1/2" F x F Brass	\$15.05	SW0200	3/8" F x M Brass



90° BOOM SWIVEL

SPRAYING SYSTEMS CO.



- Pressure loading of swivel is balanced so that it will swivel easily at all pressures up to 2000 PSI.
- Rated to temperatures up to 200° F. Nickel-plated brass construction with Buna O-rings and Delrin bearings.

\$36.92	SWKR690	3/8" M x F
\$3.42	SWKR690K	Repair Kit



STRAIGHT SWIVEL

SPRAYING SYSTEMS CO.

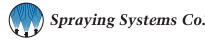

- Brass Max PSI: 1000 | Stainless Max PSI: 3000
- Stainless steel or brass construction
- Bearings are self-lubricated Teflon filled acetal for long life and low torque requirements
- **MAX TEMP:** 200°F

\$72.70	SW0215	3/8" M x F Stainless Steel
\$17.42	SW0215K	Repair Kit 3/8" SS
\$44.76	SW0230	3/8" M x F Brass



HIGH PRESSURE SWIVEL

SUTTNER



- High-pressure swivel
- Chrome-plated, brass with stainless steel internals
- 3/8" F x F, or 3/8" M x F • **MAX. TEMP.:** 300°F
- **MAX PRESSURE:** 3000 PSI • **FLOW:** 5 GPM

\$17.26	SUT300FF	3/8" F x F
\$15.42	SUT300MF	3/8" M x F

AUTOMATIC SWIVELS



BIG BOY

ROLLER BEARING SWIVELS

- For tough applications like touchless automatics or high-pressure hose reels. BBS580 Series Swivels are designed for high speed, high torque automatics such as Hydro Spray.

PRICE	PART#	SIZE
\$210.78	BBS580	1/2" M x 1/2" F Brass
\$210.78	BBS580A	1/2" M x 3/4" F Brass
\$201.71	BBS580ASS	1/2" M x 3/4" F SS

PRICE	PART#	SIZE
\$213.48	BBS580C	3/4" M x 3/4" F Brass
\$210.99	BBS580CSS	3/4" M x 3/4" F SS
\$202.53	BBS580SS	1/2" M x 1/2" F SS

USE THESE KITS TO REBUILD YOUR SWIVELS

BEARING REPLACEMENT KIT

FITS ALL BIG BOY SWIVELS

- **CONTAINS:** • (2) Roller Bearings • (2) Races

CALL **BBBRK**

BASIC RE-SEAL KIT

FITS ALL BIG BOY SWIVELS

- **CONTAINS:** • (2) O-Rings Internal Lubrication • (2) Back O-Rings • (1) Instruction Sheet

CALL **BBORR**

DO NOT OVERGREASE SWIVELS. DO NOT USE ANY GREASE THAT CONTAINS GRAPHITE OR MOLYBDENUM



PARKER® PS Series swivels are designed to eliminate hose twist and torque that may cause premature hose failure. These swivels have a full flow, sealed bearing design with hardened bearing races that are resistant to side load and are suitable for high pressure. PS Series swivels are available in 90° and in-line configurations with a wide variety of port ends, making them ideal for an array of dynamic applications.

GUN SWIVELS



4000 PSI LIVE GUN SWIVEL

MOSMATIC



mosmatic

- It is well known that Mosmatic swivels turn freely even under high pressure.
- Made of corrosion resistant material and stainless steel self-lubricating bearings, the new gun swivel offers the highest quality Swiss made craftsmanship.

PRICE	PART #	SIZE
CALL	SWM32552	1/4" M x 1/4" F
	SWM32561	3/8" M x 1/4" M
	SWM32562	3/8" M x 1/4" F

PRICE	PART #	SIZE
CALL	SWM32563	3/8" M x 3/8" M
	SWM32564	3/8" M x 3/8" F
	SWM32569	3/8" F x 3/8" F
	SWM32864	1/2" M x 1/2" F

STRAIGHT SWIVEL

MOSMATIC

mosmatic



- Dual Bearing System • Live Under Pressure • Multiple Seals System • Maintenance Free • 4000 PSI

PRICE	PART#	SIZE
CALL	SWM30051	1/4" F x M
	SWM30052	1/4" F x F
	SWM30153	3/8" M x F
	SWM30154	3/8" F x F

PRICE	PART#	SIZE
CALL	SWM30053	3/8" M x 1/4" F
	SWM30054	1/4" F x 3/8" F
	SWM30014	G1/4" x 3/8" FNPT Old Style
	SWM30654	3/8" F x F New Style

BALL BEARING SWIVEL

THE SPECIALTY MFG. CO.

THE SPECIALTY MFG. CO.
Custom In Our Specialty

- Constructed of electroless nickel-plated brass construction
- Cap ends are precision machined for heavy-duty leak proof service
- High-pressure seal is Teflon backed Buna-N. Bearing seal is vented between the high-pressure seal.
- Max Pressure: 1500 PSI, Liquid 250 PSI Air

PRICE	PART #	SIZE
\$22.99	SW0120	1/4" M x F
\$22.99	SW0125	1/4" F x F
\$23.85	SW0240	3/8" M x F

PRICE	PART #	SIZE
\$23.85	SW0245	3/8" F x F
\$14.83	SW0245K	Kit for 1/4" & 3/8"
\$23.85	SW0241	3/8" M x 1/4" F

SONIC SWIVEL

- Nickel plated brass with stainless steel ball bearings

PRICE	PART#	SIZE
\$29.25	SON38MF	3/8" M x F
\$39.50	SON38MFN	90° 3/8" M x F
\$29.25	SON14MF	1/4" M x F

PRICE	PART#	DESCRIPTION
\$4.99	SONKIT	Repair Kit for 3/8" & 1/4" 90°

SWIVELS



90° BOOM SWIVEL

KLEEN-RITE SWIVEL



KLEEN-RITE corp

- Use wherever hose moves or twists • Low torque • Sealed against dust
- Long-life seal • 360° swivel action • 300° F temp. rating • Viton O-rings

PRICE	PART#	SIZE	PRESSURE / FLOW
\$26.82	SW4000	3/8" M x F	3000 PSI/7 GPM
\$13.51	SW4000KN	NEW STYLE Repair Kit 3/8" M x F For Swivel w/ Groove	
\$35.54	SW4000SS	3/8" STAINLESS	5000 PSI/7 GPM

SWIVELS



3/8" M x F SWIVEL
U.S. PARA PLATE



\$15.64	SW0290	Brass
\$25.50	SW0290SS	Stainless Steel



3/4" M x F SWIVEL
DEUBLIN



- 90° (radial) hose connection
- 3000 PSI / 250°F
- Nickel-plated rotor and housing

PRICE	KR #	MFG. #
\$298.01	SW1600	21-040-101



90° BOOM SWIVEL
FLUID CONTROLS



- Brass construction with stainless steel precision thrust bearings
- Excellent for hose reels & overhead booms
- Repairable

PRICE	PART#	DESCRIPTION
\$33.85	SW0273	1/4" M x F Brass BB - 3500 PSI
\$34.18	SW0275	3/8" M x F Brass BB - 2000 PSI
\$7.46	SW0260K	Repair Kit for 1/4" & 3/8"

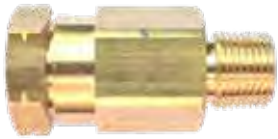

BRASS BALL BEARING SWIVEL
VALUE LINE



- 3/8" M x F

\$14.99	SWV500
----------------	---------------



3/8" M x F SWIVEL
DEUBLIN



- 90° (radial) hose connection
- 3000 PSI / 250°F
- Nickel-plated rotor and housing

PRICE	KR #	MFG. #
\$182.73	SW1500	17-058-056



INLINE SWIVEL

PRICE	PART#	HOSE X MPT
\$7.58	HF0120	1/4" x 1/4"
\$8.99	HF0121	3/8" x 3/8"
\$9.94	HF0122	3/8" x 1/2"
\$10.95	HF0123	1/2" x 1/2"
\$9.54	HF0127	1/2" x 3/8"



STRAIGHT SWIVEL
VALUE LINE



- 3/8" M x F

\$10.90	SWV38SS	Stainless Steel
\$7.76	SWV38	Brass



90° BOOM SWIVEL
VALUE LINE



- Sealed against dust
- 360° swivel action
- Viton O-rings
- 3/8" M x 3/8" F
- 7 GPM
- Long-life seal
- 300° F temp. rating
- Low torque
- 3000 PSI Max Pressure

\$19.81	SWV520
----------------	---------------



3/4" NPT SWIVEL
DEUBLIN



- 90° (radial) hose connection
- **MAXIMUM HOT OIL PRESSURE:** 100 PSI
- **MAXIMUM STEAM PRESSURE:** 15 PSI
- **MAXIMUM WATER GLYCOL PRESSURE:** 750 PSI
- **MAXIMUM WATER PRESSURE:** 750 PSI
- 1500 RPM / 250°F
- **TORQUE RATING:** 0.5 foot pounds
- **STAINLESS STEEL ROTOR:** 3/4" NPT RH thread

PRICE	KR #	MFG. #
\$279.38	SW1700	255-324-976



90° BOOM SWIVEL
THE SPECIALTY MFG. CO.



- 11 1/2 GPM
- 3/8" M x 3/8" F connection
- Stainless Stem
- 1500 PSI Max pressure
- Brass Body

\$29.60	SW3800	90° Boom Swivel
\$7.97	SW3800K	Repair Kit



SWIVELS

90° HIGH PRESSURE SWIVELS

SUPER SWIVELS

- Ideal selection for use as replacement swivels on automatic car washes, hose reels and ceiling booms
- Live swivel ball bearing design
- Maximum temperature is 400°F
- Rebuildable
- Ideal for use with hot water, hydraulic fluid, insecticides, etc.
- Nickel plated alloy steel
- Up to 5000 PSI



1" F x F
SUPER SWIVELS

\$98.36	SWS1690FF	1" F x F
\$14.59	SWS16K	Repair Kit



1" M x F
SUPER SWIVELS

\$98.36	SWS1690	1" M x F
\$14.59	SWS16K	Repair Kit



1" NPTF x 1" NPTF
90° EXTENDED SWIVEL
SUPER SWIVELS

- 2.18" diameter body
- 1.625" wrench hex
- 4000 PSI maximum
- 0.827" through hole
- Nickel plated construction

\$159.27	SWSD1602
-----------------	-----------------



3/4" M x F
SUPER SWIVELS

\$79.19	SWS1290	3/4" M x F
\$10.15	SWS1290K	Repair Kit



3/4" F x F
SUPER SWIVELS

\$79.19	SWS1290FF	3/4" F x F
\$10.15	SWS1290K	Repair Kit



1/4" M x F
SUPER SWIVELS

\$55.44	SWS0490	1/4" M x F
\$8.56	SWS0490K	Repair Kit



1/2" M x F
SUPER SWIVELS

\$63.22	SWS0890	1/2" M x F
\$9.87	SWS0690K	Repair Kit



1/2" F x F
SUPER SWIVELS

\$63.22	SWS0890FF	1/2" F x F
\$9.87	SWS0690K	Repair Kit



3/8" M x F
SUPER SWIVELS

\$63.22	SWS0690	3/8" M x F
\$9.87	SWS0690K	Repair Kit

DOUBLE BEARING SWIVELS

SUPER SWIVELS

- Live swivel ball bearing design
- Rebuildable
- Maximum temperature is 400°F
- Nickel plated alloy steel
- Ideal for use with hot water, hydraulic fluid, insecticides, etc.
- 5000 PSI

90° DOUBLE BEARING SWIVELS



1" F x F
SUPER SWIVELS

\$122.15	SWSD169FF	1" F x F
\$17.26	SWSDB16K	Repair Kit



1/2" M x F
SUPER SWIVELS

\$72.45	SWSD89MFG	1/2" M x F
\$13.96	SWSDB08K	Repair Kit

WITH GREASE RELIEF VALVE

WITH GREASE RELIEF VALVE

INLINE DOUBLE BEARING SWIVELS



1" F x F
SUPER SWIVELS

\$112.22	SWSD16FF	1" F x F
\$17.26	SWSDB16K	Repair Kit



1/2" M x F
SUPER SWIVELS

\$72.43	SWSD8MF	1/2" M x F
\$13.96	SWSDB08K	Repair Kit



1" F x F PIPE "EXTENDED" STRAIGHT SWIVEL
SUPER SWIVELS

- Double bearing
- Nickel plated carbon steel

\$152.67	SWSD1601	1" F x F
-----------------	-----------------	----------



SWIVELS



90° HIGH PRESSURE SWIVEL

SUPER SWIVELS

- Used in popular brand automatics
- 3500 PSI

\$204.51	SWS08MF	1/2" M x F
\$47.69	SWS0890SK	Repair Kit



90° HIGH BALANCE SWIVEL

SUPER SWIVELS

- 2000 PSI

\$231.09	SWS082	1/2" M x F
\$231.09	SWS12	3/4" M x F
\$51.13	SWS20198	Repair Kit (w/o bearings)
\$68.05	SWS20197	Repair Kit (w/ bearings)



90° HIGH PRESSURE SWIVEL

SUPER SWIVELS

- Used in popular brand automatics like Hydro-Spray
- 3000 PSI

\$94.44	SWS1290HS	3/4" M x F
\$10.15	SWS1290K	Repair Kit



90° SHAFTED SWIVEL 3/4" M x F

SUPER SWIVELS

- Used in popular brand automatics
- Slotted drive shaft
- 3000 PSI

\$267.53	SWS1290SS	3/4" M x F
-----------------	------------------	------------



INLINE SWIVEL

SUPER SWIVELS

- This high-pressure swivel has chrome ball bearing design for added life
- Easily rebuildable, superior quality alloy steel
- Burnished (micro smooth) barrel bores
- 5000 PSI

\$50.07	SWS04MF	1/4" M x F
\$51.81	SWS06	3/8" F x F
\$51.81	SWS06MF	3/8" M x F
\$54.83	SWS08	1/2" F x F
\$68.69	SWS12MF	3/4" M x F
\$93.49	SWS16MF	1" M x F

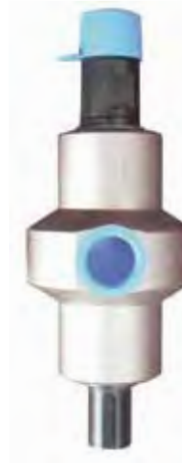

90° SHAFTED SWIVEL 1/2" M x F

SUPER SWIVELS

- Slotted drive shaft
- Used in popular brand automatics
- 1500 PSI

\$230.85	SWS0890S	1/2" M x F
\$47.69	SWS0890SK	Repair Kit

SUPER SWIVELS® WAS ESTABLISHED IN 1986 AND IS A LEADER IN THE DESIGN AND MANUFACTURING OF HYDRAULIC LIVE SWIVELS.

Super Swivels uses a heat treating process that allows for a higher working pressure rating. These superior quality, heavy-duty, leak free live swivels are sure to get the job done. Available in several materials, plating options and a wide variety of seal options.

MOSMATIC AUTOMATIC CAR WASH SWIVEL CONVERSIONS



STAINLESS STEEL CLEANING HEAD SPIDER

MOSMATIC

- Features reinforced self-lubricating ball bearings and a long-lasting carbon seal system
 - 2500 PSI maximum pressure
 - 1" FNPT inlet
 - 250° Fahrenheit maximum pressure
- Includes: (1) High RPM Swivel (39.905)
(1) 4s4 Rotor Arm (88.796)
(4) Stabilizer Nozzles (14.933)

CALL SWMTA81944



T-BAR FOR N/S QUADRA, RAINMAKER CLASSIC

MOSMATIC

- T-Bar Diameter 24: -24" TUA-4h4, G $\frac{3}{8}$ "F, 4 Arms, 4 Nozzle Outlets $\frac{1}{8}$ " NPTF

CALL SWMT86911



90° DEGREE WDS SWIVEL

MOSMATIC

- For the PDQ Laserwash G5 vehicle wash system
- Great for in-bay automatics and tunnel washes

CALL SWM40936



90° HIGH FLOW DGE ROTARY UNION FOR PDQ

MOSMATIC

- High Flow
- Nickel-plated brass with stainless steel inner parts
- 1" NPTF

CALL SWM34885



New!

43.453 WDE 90° ROTARY UNION SWIVEL

MOSMATIC

- $\frac{1}{2}$ " NPTF x $\frac{1}{2}$ " NPTM
- Nickel-plated brass construction
- Max PSI: 4000 • Max Temp: 250° F

CALL SWM43453



New!

43.458 WDE 90° ROTARY UNION SWIVEL

MOSMATIC

- $\frac{1}{2}$ " NPTF x $\frac{1}{2}$ " NPTF
- Nickel-plated brass construction
- Max PSI: 4000 • Max Temp: 250° F

CALL SWM43458



90° SWIVEL WDR SERIES

MOSMATIC

- Sealed stainless steel ball bearings and stainless steel corrosion protector plates ensure longevity.
- Compatible Systems: Hydro-Spray, Rainmaker, AVW, and Southern Pride

CALL	SWM41261	$\frac{1}{2}$ " NPTF x M
	SWM41361	$\frac{3}{4}$ " NPTF x M
	SWM41922	$\frac{3}{4}$ " NPTF x F



90° SWIVEL FOR D&S 5000, AUTEAC, JIM COLEMAN

MOSMATIC

- WDBL-10
- $\frac{3}{8}$ " FNPT - $\frac{3}{8}$ " MNPT

CALL SWM43262

KLEEN-RITE RECOMMENDED



WASHWORLD BROADWAY PDQ

MOSMATIC

- Swivel High flow DGR4-20
- 1" NPTF - 1" NPTF Inox

CALL SWM34927



90° SWIVEL FOR COBRA, ECONOCRAFT MARK VII AQUA JET, OASIS

MOSMATIC

- High flow WDRS series
- $\frac{1}{2}$ " NPTF - $\frac{1}{2}$ " NPTM

CALL SWM41920



AUTEAC

MOSMATIC

- WDRS $\frac{3}{4}$ " NPTF x F
- $\frac{3}{4}$ " Motor

CALL SWM41922

SWIVELS



MOSMATIC HIGH SPEED SWIVELS & MORE



SWIVEL WITH MOUNTING FLANGE

MOSMATIC

CALL	SWM58063	1/4" F x G 3/8" M
	SWM58163	3/8" F x G 3/8" M



INLINE SWIVEL

MOSMATIC

CALL	SWM55063	1/4" F x G 3/8" M
	SWM55163	3/8" F x G 3/8" M



New!

1/4" MNPT STABILIZER HOUSING

MOSMATIC

- Designed for compatibility with a 1/4" male NPT spray nozzle
- Replace a worn or damaged stabilizer housing on your Mosmatic Wheelblaster Pro
- Stainless steel construction

CALL	BOMP14901	1/4" MNPT
	BOMP14902	1/8" MNPT



SWIVEL WITH BULKHEAD FITTING

MOSMATIC

CALL	SWM57063	1/4" F x G 3/8" M
	SWM57163	3/8" F x G 3/8" M



SWIVEL WITH HD BEARINGS

MOSMATIC

CALL	SWM59163	3/8" F x G 3/8" M
------	----------	-------------------



New!

STAINLESS STEEL WHEELBLASTER PRO

MOSMATIC

- An adjustable wheel washing head on a standing pole that can be placed anywhere you want in your automatic car wash
- Wash Head; part #84.596 (4"/4" Wash Head also available; part #84.586)
- 39" Pole Stand; part #903.986
- DYT Swivels; part #59.753
- Stabilizer Housings; part #14.901
- 6"/6" Rotor Arm

CALL	SWMTA84546
------	------------



STAINLESS STEEL WHEELBLASTER

MOSMATIC

- Used with Wheelblaster Pro wash heads
- Wash head can be adjusted to any height along the entire stand
- 39" polished stainless steel
- Use with 4"/4" wash heads (part #84.586) and 6"/6" wash heads (part #84.596)

\$195.75	SWMTC903986	Stand
\$907.59	SWMTC84586	Wheel Blaster Pro Head

90° BOOM REPLACEMENT SWIVELS

MOSMATIC

CALL	SWM40009 (Old Style Boom)	G 1/4" F x G 1/4" M	4000 PSI
	SWM40019* (New Style Boom)	G 1/4" F x 3/8" FNPT	4000 PSI

*SWMK90N IS THE SEAL KIT FOR SWM40019

90° BOOM SWIVEL

MOSMATIC

- Multiple seal system for both low and high pressure prevents leakage
- Totally corrosion-resistant version ensures longevity
- Compact and lightweight • Easy installation

PRICE	PART#	SIZE	NIPPLE SIZE	PSI	
CALL	SWM40022	1/4 NPTF x 3/8 NPTM	Short	4000	
	SWM40029	1/4 NPTF x 3/8 NPTM	Long	2200	
	SWM40021**	1/4" F x M	Short	4000	
	SWM40032	3/8" F x M	Short	2200	
	SWM40031**	3/8" NPTF x 1/4 NPTM	Short	4000	
	SWM40028	1/4" F x M	Long	2200	
	SWM40039	3/8" F x M	Long	4000	
	SWMK90	Kit for 90° Style Without Washer			
	SWMK90N	Kit for 90° Style With Washers			

**NOT FOR USE WITH MOSMATIC BOOMS

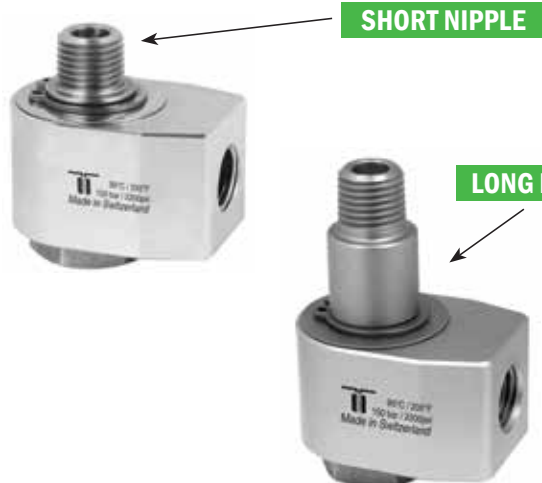

SHORT NIPPLE

LONG NIPPLE

MOSMATIC HIGH SPEED SWIVELS & MORE



UNDERCARRIAGE CLEANING SYSTEM MOSMATIC

- For sub-floor and fixed ramp automatic car washes
- Boasts industrial-grade stainless steel plates and boxes with quad bearing swivels and welded rotor arms
- Thoroughly clean a vehicle's underside without causing any damage
- Max Pressure: 4000 PSI
- Max Temp: 250°F
- Max RPM: 2000
- 3/4" NPTF water connection
- 1" NPTF water drain

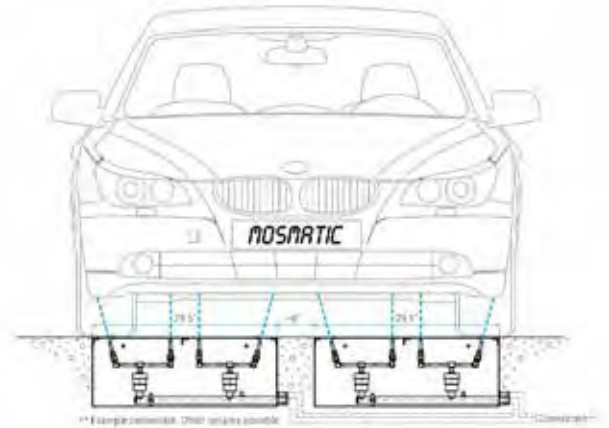
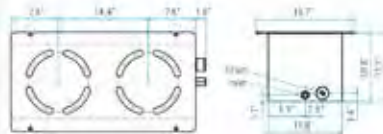

<https://www.mosmatic.com/downloads/catalog/MA24/>

CALL UCM80640

New!

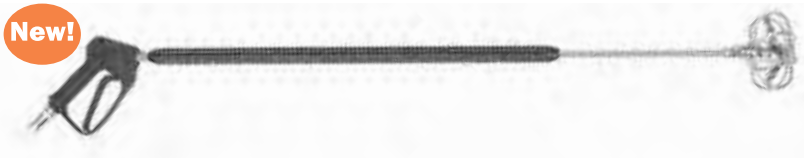

CLEANING WAND WITH STAINLESS STEEL SPINNING WASH HEAD MOSMATIC

- Achieve incredible spraying capability in some of the most difficult-to-reach areas!

SPECIFICATIONS:

- **INLET:** 3/8" NPTF
- **MAX PRESSURE:** 4000 PSI
- **MAX TEMP:** 250 °F
- 62" length
- 6" head circumference
- 3-12 pH throughput
- 0502 nozzles

PRODUCT INCLUDES:

- (1) Wand
- (1) SS rotating cleaner head
- (3) 0502 spray nozzle tips
- (1) High-pressure gun
- (1) Gun swivel

CALL PWM81925

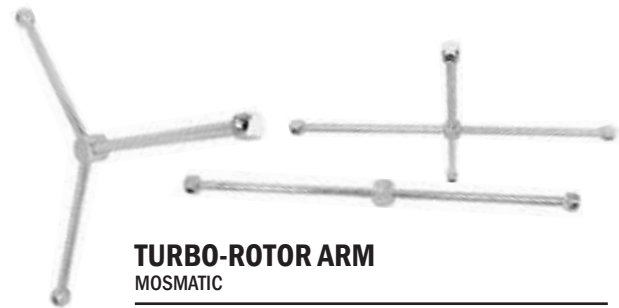

TURBO-ROTOR ARM MOSMATIC

- The turbo rotor arm, in conjunction with a swivel, begins to turn on its own from the water pressure. This product is found mainly in automatic car wash facilities in the area of rim and finish cleaning.

CALL	SWMTA82811	16" Two-Arm
	SWMTA82812	18" Two-Arm
	SWMTA82872	18" Three-Arm
	SWMTA82837	16" Four-Arm

More available sizes online

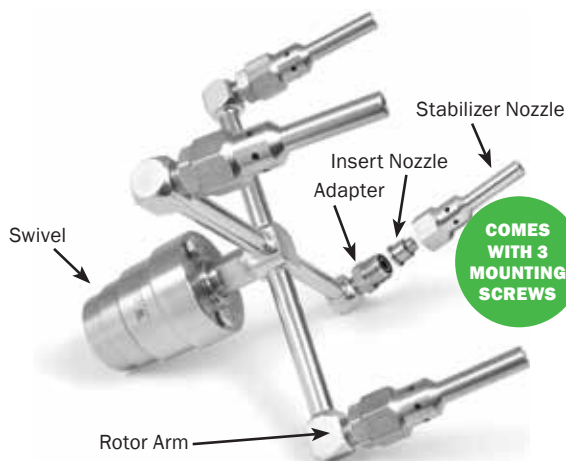

ROTATION SYSTEM MOSMATIC

- As the water pressure builds, the rotor arms begin to rotate independently. The arm rotates only by the force of the water jet and requires no other power. A simple but efficient and solid product for a optimal cleaning effect.
- Max Pressure: 5000 PSI • Max. Temp: 250°F • Stab. Nozzle / Adapter (4) 14.901

PRICE	PART #	G1 (F)	NW	ROTARY UNION	ROTOR ARM	INSERT NOZZLE
CALL	SWMT81920	1/4" NPTF	1/4"	DYT (59.063)	4w4 (82.954)	(4 Required) 0004EG*
	SWMT81922	3/8" NPTF	1/4"	DYT (59.163)	4w4 (82.954)	(4 Required) 0004EG*

* NOT INCLUDED

HOSES & FITTINGS



JOHN GUEST® POLY-TUBE FITTINGS



10 PACK 1/4" MALE CONNECTORS (TUBE X MIP)
JOHN GUEST POLY-TUBE FITTINGS

\$12.10 JG4MC4-10



10 PACK 1/4" CONNECTORS (TUBE X TUBE UNION)
JOHN GUEST POLY-TUBE FITTINGS

\$20.10 JG4UC4-10



2-WAY DIVIDER (TUBE X TUBE)
JOHN GUEST POLY-TUBE FITTINGS

PRICE	PART #	TUBE	TUBE
\$4.37	JG4DV	1/4"	1/4"
\$4.10	JG6DV	3/8"	3/8"
\$4.37	JG8DV	1/2"	1/2"



SHUT-OFF VALVE (TUBE X TUBE)
JOHN GUEST POLY-TUBE FITTINGS

PRICE	PART #	TUBE
\$6.79	JG4SV	1/4"
\$7.18	JG6SV	3/8"



SHUT-OFF VALVE (TUBE X MIP)
JOHN GUEST POLY-TUBE FITTINGS

PRICE	PART #	TUBE	MIP
\$6.79	JGSV4T4M	1/4"	1/4"
\$7.18	JGSV6T6M	3/8"	3/8"



SWIVEL BRANCH TEE (MIP X TUBE X TUBE)
JOHN GUEST POLY-TUBE FITTINGS

PRICE	PART #	TUBE	MIP
\$4.37	JG4MT2	1/4"	1/8"
\$4.37	JG4MT4	1/4"	1/4"



FEMALE CONNECTOR (TUBE X FIP)
JOHN GUEST POLY-TUBE FITTINGS

PRICE	PART #	TUBE	FIP
\$3.53	JG4FC4	1/4"	1/4"
\$4.37	JG6FC4	3/8"	1/4"



REDUCING ELBOW
JOHN GUEST POLY-TUBE FITTINGS

PRICE	PART #	TUBE	TUBE
\$4.24	JG6RE4	3/8"	1/4"
\$5.04	JG8RE6	1/2"	3/8"



REDUCING UNION
JOHN GUEST POLY-TUBE FITTINGS

PRICE	PART #	TUBE	TUBE
\$3.05	JG6RU4	3/8"	1/4"
\$4.12	JG8RU6	1/2"	3/8"



END STOP
JOHN GUEST POLY-TUBE FITTINGS

PRICE	PART #	TUBE
\$1.51	JG4ES	1/4"
\$1.87	JG6ES	3/8"



REDUCER
JOHN GUEST POLY-TUBE FITTINGS

PRICE	PART #	TUBE	STEM
\$2.45	JG6R4	1/4"	3/8"
\$4.70	JG8R6	1/2"	3/8"



PLUG FOR TUBE CONNECTOR
JOHN GUEST POLY-TUBE FITTINGS

PRICE	PART #	TUBE
\$0.63	JG4P	1/4"
\$1.05	JG6P	3/8"



HOSE BARB
JOHN GUEST POLY-TUBE FITTINGS

PRICE	PART #	TUBE	BARB
\$1.42	JG4T4H	1/4"	1/4"
\$2.09	JG6T4H	3/8"	1/4"
\$2.25	JG6T6H	3/8"	3/8"



STEM PLUG IN ELBOW
JOHN GUEST POLY-TUBE FITTINGS

PRICE	PART #	TUBE	STEM
\$2.30	JG4PIE4	1/4"	1/4"
\$3.08	JG4PIE6	1/4"	3/8"
\$3.94	JG6PIE6	3/8"	3/8"
\$4.72	JG8PIE8	1/2"	1/2"



BULKHEAD UNION
JOHN GUEST POLY-TUBE FITTINGS

PRICE	PART #	TUBE	MIP	THREAD
\$4.29	JG4BU	1/4"	1/4"	3/8M
\$5.58	JG6BU	3/8"	3/8"	1/2M
\$9.57	JG8BU	1/2"	1/2"	3/4M



UNION TEE (TUBE X TUBE X TUBE)
JOHN GUEST POLY-TUBE FITTINGS

PRICE	PART #	TUBE
\$3.24	JG4UT	1/4"
\$4.03	JG6UT	3/8"
\$4.87	JG8UT	1/2"



UNION ELBOW (TUBE X TUBE)
JOHN GUEST POLY-TUBE FITTINGS

PRICE	PART #	TUBE
\$2.54	JG4EL	1/4"
\$3.83	JG6EL	3/8"
\$4.62	JG8EL	1/2"



SWIVEL ELBOW
JOHN GUEST POLY-TUBE FITTINGS

PRICE	PART #	TUBE	MIP
\$3.69	JG4SE4	1/4"	1/4"
\$4.87	JG5SE4	5/16"	1/4"
\$5.16	JG6SE4	3/8"	1/4"
\$5.38	JG6SE6	3/8"	3/8"



STEM ADAPTER
JOHN GUEST POLY-TUBE FITTINGS

PRICE	PART #	TUBE	MIP
\$0.77	JG4SA2	1/4"	1/8"
\$0.77	JG4SA4	1/4"	1/4"
\$0.97	JG6SA4	3/8"	1/4"
\$1.29	JG6SA6	3/8"	3/8"
\$2.09	JG8SA6	1/2"	3/8"
\$2.09	JG8SA8	1/2"	1/2"



MALE CONNECTOR (TUBE X MIP)
JOHN GUEST POLY-TUBE FITTINGS

PRICE	PART #	TUBE	MIP
\$1.51	JG4MC2	1/4"	1/8"
\$1.73	JG4MC4	1/4"	1/4"
\$2.27	JG4MC6	1/4"	3/8"
\$2.45	JG6MC4	3/8"	1/4"
\$3.83	JG8MC6	1/2"	3/8"
\$4.12	JG8MC8	1/2"	1/2"



FIXED ELBOW (MIP X TUBE)
JOHN GUEST POLY-TUBE FITTINGS

PRICE	PART #	TUBE	MIP
\$2.25	JG4ME2	1/4"	1/8"
\$2.55	JG4ME4	1/4"	1/4"
\$3.05	JG4ME6	1/4"	3/8"
\$3.83	JG6ME4	3/8"	1/4"
\$4.17	JG6ME6	3/8"	3/8"



CHECK VALVE
JOHN GUEST PLUMBING FITTINGS

PRICE	PART #	TUBE
\$12.63	JG4CV	1/4"
\$12.96	JG6CV	3/8"



CROSS (TUBE X TUBE X TUBE)
JOHN GUEST POLY-TUBE FITTINGS

PRICE	PART #	TUBE
\$7.12	JG6CR	3/8"



UNION CONNECTOR (TUBE X TUBE X TUBE)
JOHN GUEST POLY-TUBE FITTINGS

PRICE	PART #	TUBE
\$2.25	JG4UC4	1/4"
\$2.39	JG5UC5	5/16"
\$3.01	JG6UC6	3/8"
\$3.53	JG8UC8	1/2"

HOSES & FITTINGS

JOHN GUEST® GENERAL PLUMBING FITTINGS



BRASS MALE CONNECTOR

JOHN GUEST PLUMBING FITTINGS

PRICE	PART #	SIZE
\$8.32	PEX8BMC8	1/2" CTS x 1/2" NPT
\$10.06	PEX12BMC12	3/4" CTS x 3/4" NPT



BRASS STEM

JOHN GUEST PLUMBING FITTINGS

PRICE	PART #	SIZE
\$9.46	PEX8BMA8	1/2" CTS x 1/2" NPT



PEX REDUCING TEE

JOHN GUEST PLUMBING FITTINGS

PRICE	PART #	SIZE
\$8.43	PEX1212RT8	3/4" x 3/4" x 1/2" CTS
\$7.78	PEX88RT12	1/2" x 1/2" x 3/4" CTS
\$8.43	PEX128RT12	3/4" x 1/2" x 3/4" CTS



PEX FEMALE SWIVEL CONNECTOR

JOHN GUEST PLUMBING FITTINGS

PRICE	PART #	SIZE
\$4.13	PEX8FSC8	1/2" CTS x 1/2" NPS



PIPE CLIP

JOHN GUEST PLUMBING FITTINGS

PRICE	PART #	SIZE
\$0.35	PEX12PC	3/4" x 3/4" CTS



END CAP

JOHN GUEST PLUMBING FITTINGS

PRICE	PART #	SIZE
\$8.32	PEX12EC	3/4" CTS
\$10.06	PEX16EC	1" CTS



PIPE INSERT

JOHN GUEST PLUMBING FITTINGS

PRICE	PART #	SIZE
\$0.46	PEX8PI	1/2" CTS
\$0.69	PEX12PI	3/4" CTS
\$1.36	PEX16PI	1" CTS



PIPE CUTTERS

JOHN GUEST PLUMBING FITTINGS

PRICE	PART #	ITEM
\$79.34	PEXHDCUTTER	Heavy Duty Pipe Cutter
\$46.83	PEXCUTTER	Pipe Cutter



NAIL CLIP

JOHN GUEST PLUMBING FITTINGS

PRICE	PART #	SIZE
\$0.17	PEX8NC	1/2" x 1/2" CTS
\$0.18	PEX12NC	3/4" x 3/4" CTS



PLASTIC TUBE SNIP

TUBE CUTTERS AND ACCESSORIES

PRICE	PART #
\$10.62	JGSNIP



BRASS FEMALE DROP EAR ELBOW

JOHN GUEST PLUMBING FITTINGS

PRICE	PART #	SIZE
\$14.37	PEX8FDEE8	1/2" CTS x 1/2" FNPT



PEX REDUCER

JOHN GUEST PLUMBING FITTINGS

PRICE	PART #	SIZE
\$5.12	PEX12R8	3/4" STEM x 1/2" PIPE
\$6.77	PEX16R12	1" STEM x 3/4" PIPE



PEX STACKABLE TEE

JOHN GUEST PLUMBING FITTINGS

PRICE	PART #	SIZE
\$4.20	PEX88ST8	1/2" CTS x 1/2" Stem x 1/2" CTS
\$8.70	PEX1212ST8	3/4" CTS x 3/4" Stem x 1/2" CTS
\$9.46	PEX1212ST12	3/4" CTS x 3/4" Stem x 3/4" CTS



PEX FEMALE SWIVEL ELBOW

JOHN GUEST PLUMBING FITTINGS

PRICE	PART #	SIZE
\$6.18	PEX8FSE8	1/2" CTS x 1/2" NPS



PEX PLUG-IN ELBOW

JOHN GUEST PLUMBING FITTINGS

PRICE	PART #	SIZE
\$5.10	PEX12PEL12	3/4" STEM x 3/4" PIPE



PEX UNION ELBOW

JOHN GUEST PLUMBING FITTINGS

PRICE	PART #	SIZE
\$13.11	PEX16UEL	1" x 1" CTS



PEX COUPLER

JOHN GUEST PLUMBING FITTINGS

PRICE	PART #	SIZE
\$4.53	PEX8C	1/2" x 1/2" CTS
\$5.96	PEX12C	3/4" x 3/4" CTS
\$11.57	PEX16C	1" x 1" CTS



SUPERSEAL PIPE INSERT

JOHN GUEST PLUMBING FITTINGS

PRICE	PART #	SIZE
\$0.64	PEX12SPI	3/4" x 3/4" CTS

NOTE: This is a clearance item with limited inventory. All sales final - no returns.



PEX UNION TEE

JOHN GUEST PLUMBING FITTINGS

PRICE	PART #	SIZE
\$5.32	PEX8UT	1/2" x 1/2" CTS
\$8.88	PEX12UT	3/4" x 3/4" CTS
\$12.03	PEX16UT	1" x 1" CTS



RO MEMBRANE ELBOW CHECK

JOHN GUEST PLUMBING FITTINGS

PRICE	PART #	SIZE
\$5.89	NC2811	1/4" Tube x 1/8" NPT

HOSES & FITTINGS



SMC® PNEUMATICS CONNECTORS & ELBOWS

FITTING - 1/4" NPTF x 3/8" TUBE KQ2 ONE-TOUCH FITTINGS SMC PNEUMATICS



- Pack of 10
- Inlet size: 1/4" NPTF - Tube size: 3/8"
- Thread material: Brass
- Maximum operating pressure: 145 PSI
- Temperature range, ambient: 23°F to 140°F
- Temperature range, water: 32°F to 104°F

PRICE	KR #	SMC #
\$39.36	FFC-0406	KQ2F11-35A

90° ELBOW 1/4" NPTF x 3/8" TUBE KQ2 ONE-TOUCH FITTINGS SMC PNEUMATICS



- Pack of 10
- Inlet size: 1/4" NPTF - Tube size: 3/8"
- Thread material: Brass
- Maximum operating pressure: 145 PSI
- Temperature range, ambient: 23°F to 140°F
- Temperature range, water: 32°F to 104°F

PRICE	KR #	SMC #
\$47.71	FFE-0406	KQ2LF11-35A

90° ELBOW NPTM x TUBE KQ2 ONE-TOUCH FITTINGS SMC PNEUMATICS



- Pack of 10
- Thread material: Brass
- Maximum operating pressure: 145 PSI
- Temperature range, ambient: 23°F to 140°F
- Temperature range, water: 32°F to 104°F

PRICE	KR #	SMC #	INLET	TUBE
\$16.58	FME-0204	KQ2L07-34AS	1/8" NPTM	1/4"
\$30.76	FME-0206	KQ2L11-34AS	1/8" NPTM	3/8"
\$18.60	FME-0404	KQ2L07-35AS	1/4" NPTM	1/4"
\$26.74	FME-0406	KQ2L11-35AS	1/4" NPTM	3/8"
\$35.94	FME-0408	KQ2L13-35AS	1/4" NPTM	1/2"
\$30.97	FME-0606	KQ2L11-36AS	3/8" NPTM	3/8"
\$38.64	FME-0808	KQ2L13-37AS	1/2" NPTM	1/2"

FITTING - NPTM x TUBE KQ2 ONE-TOUCH FITTINGS SMC PNEUMATICS

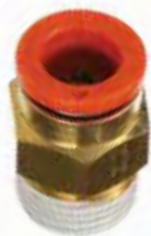

- Pack of 10
- Thread material: Brass
- Maximum operating pressure: 145 PSI
- Temperature range, ambient: 23°F to 140°F
- Temperature range, water: 32°F to 104°F

PRICE	KR #	SMC #	INLET	TUBE
\$14.17	FMC-0204	KQ2H07-34AS	1/8" NPTM	1/4"
\$24.93	FMC-0206	KQ2H11-34AS	1/8" NPTM	3/8"
\$22.66	FMC-0406	KQ2H11-35AS	1/4" NPTM	3/8"
\$23.45	FMC-0606	KQ2H11-36AS	3/8" NPTM	3/8"
\$25.69	FMC-0608	KQ2H13-36AS	3/8" NPTM	1/2"
\$25.70	FMC-0808	KQ2H13-37AS	1/2" NPTM	1/2"

FITTING - 1/4" NPTM x 3/8" TUBE WITH HEX SOCKET HEAD KQ2 ONE-TOUCH FITTINGS SMC PNEUMATICS



- Pack of 10
- Inlet size: 1/4" NPTM - Tube size: 3/8"
- Internal hexagon socket head uses sealant for watertight seal, and allows for tightening with a hex wrench when components are stacked too tight for a conventional wrench
- Thread material: Brass
- Maximum operating pressure: 145 PSI
- Temperature range, ambient: 23°F to 140°F
- Temperature range, water: 32°F to 104°F

PRICE	KR #	SMC #
\$33.92	FMC-0406-HH	KQ2S11-35AS

90° ELBOW 3/8" NPTF x 1/2" TUBE KQ2 ONE-TOUCH FITTINGS SMC PNEUMATICS



- Pack of 10
- Inlet size: 3/8" NPTF - Tube size: 1/2"
- Thread material: Brass
- Maximum operating pressure: 145 PSI
- Temperature range, ambient: 23°F to 140°F
- Temperature range, water: 32°F to 104°F

PRICE	KR #	SMC #
\$59.10	FFE-0608	KQ2LF13-36A

SEALED PLUG FITTINGS KQ2 ONE-TOUCH FITTINGS SMC PNEUMATICS



- Pack of 10 and lightweight
- Shuts unused port on one-touch fittings
- Use for a wide pressure range from low vacuum to 1MPa (approximately 145 PSI)
- Special profile seal
- Not for use in potable water systems
- Temperature Range: 23° to 140°F

PRICE	KR #	SMC #	ACCEPTS
\$5.95	FP-04	KQ2P-07	1/4" O.D. FITTINGS
\$10.51	FP-06	KQ2P-11	3/8" O.D. FITTINGS

**NOT INTENDED
FOR POTABLE
WATER SYSTEMS**

PLUG-IN REDUCERS SMC PNEUMATICS



- Pack of 10 and lightweight
- Release collar - easily remove tubing without damage
- Use for a wide pressure range from low vacuum to 1MPa (approximately 145 PSI)
- Special profile seal
- Not for use in potable water systems
- Temperature Range: 23° to 140°F

PRICE	KR #	SMC #	REDUCES
\$13.54	FPR-0604	KQ2R07-11A	3/8" to 1/4"
\$16.58	FPR-0806	KQ2R11-13A	1/2" to 3/8"

**NOT INTENDED
FOR POTABLE
WATER SYSTEMS**

SMC® PNEUMATICS CONNECTORS & ELBOWS



3/8" TO 1/4" REDUCER NIPPLE SMC PNEUMATICS

- Pack of 10 and lightweight
- Reduces a 3/8" port to accept 1/4"
- Use for a wide pressure range from low vacuum to approximately 145 PSI
- Special profile seal
- Temperature Range: 23° to 140°F

PRICE	KR #	SMC #
\$7.47	FRN-0604	KQ2N07-11

**NOT INTENDED
FOR POTABLE
WATER SYSTEMS**

STRAIGHT UNION FITTINGS SMC PNEUMATICS

- Pack of 10 and lightweight
- For vacuum and positive pressure applications
- Release collar allows easy removal of tubing without damaging the tube
- Maximum vacuum pressure of 145 PSI
- Accepts nylon and urethane tubing

PRICE	KR #	SMC #	TYPE	LENGTH
\$16.83	FSU-04	KQ2H07-00A	1/4" UNION	34.5mm
\$26.74	FSU-06	KQ2H11-00A	3/8" UNION	42.5mm
\$33.80	FSU-08	KQ2H13-00A	1/2" UNION	44.5mm



SEALED BRANCH TEE FITTINGS SMC PNEUMATICS



- 10 count pack
- 1/4" NPT connection port x 3/8" outer tubing
- Brass thread connection
- -100 kPa to 1 MPa operating pressure range
- 3 MPa proof pressure
- Temperature range, ambient: 23° to 140°F
- Temperature range, water: 32° to 104°F
- Accepts nylon and polyurethane tubes
- Stud allows body rotation for easy installation
- Release collar - easily remove tubing w/o damage
- Use for a wide pressure range from low vacuum to approximately 145 PSI

PRICE	KR #	SMC #	PORT	TUBE
\$39.15	FMT-0406	KQ2T11-35AS	1/4" NPTM	3/8"
\$55.57	FMT-0408	KQ2T13-35AS	1/4" NPTM	1/2"



**NOT INTENDED
FOR POTABLE
WATER SYSTEMS**

STAINLESS STEEL BRANCH TEE CONNECTOR SMC PNEUMATICS

- 316 Stainless steel construction
- FMK seal material • Grease-Free
- 1/2" ports and lightweight

PRICE	KR #	PORTS
\$71.73	KQG2T13-00	1/2"



SPEED CONTROL ELBOW FITTING SMC PNEUMATICS

- For nylon, soft nylon, polyurethane tubing connections
- 1/4" NPT x 3/8" Tube • Max pressure: 145 PSI
- Lightweight and easy to install/adjust

PRICE	KR #	SMC #
\$15.80	SMC160	AS3201F-N02-11SA



KQ2T11-00A ONE-TOUCH UNION TEE SMC PNEUMATICS

- Pack of 10 and lightweight
- For vacuum and positive pressure applications
- Release collar allows easy removal of tubing without damaging the tube
- Maximum vacuum pressure of 145 PSI
- Accepts nylon and urethane tubing

PRICE	KR #	SMC #	TYPE	LENGTH
\$38.35	FUT-06	KQ2T11-00A	3/8" UNION	26mm
\$49.99	FUT-08	KQ2T13-00A	1/2" UNION	29mm

KQ2U11-00A ONE-TOUCH UNION Y SMC PNEUMATICS

- Pack of 10 and lightweight
- Applicable for vacuum and positive pressure applications
- Release collar allows easy removal of tubing without damaging the tube
- Maximum vacuum pressure of 145 PSI
- Accepts nylon and urethane tubing

PRICE	KR #	SMC #	TYPE	ACCEPTS
\$66.20	FUY-06	KQ2U11-00A	3/8" UNION	3/8" O.D. Tubes
\$83.54	FUY-08	KQ2U13-00A	1/2" UNION	1/2" O.D. Tubes



KQ2L11-00A UNION ELBOW SMC PNEUMATICS

- 10 count pack
- 3/8" UNF inlet x 3/8" UNF tubing
- Brass thread material
- Temperature range, ambient: 23° to 140°F
- Temperature range, water: 32° to 104°F
- Maximum operating pressure of 145 PS

PRICE	KR #	SMC #	PORT	TUBE
\$35.06	FUE-06	KQ2L11-00A	3/8"	3/8"



STAINLESS STEEL STRAIGHT MALE ONE-TOUCH CONNECTOR SMC PNEUMATICS

- 316 Stainless steel construction
- 3/8" Tubing x 1/4" NPT
- FMK seal material
- Grease-Free
- Compact and lightweight

PRICE	KR #	INLET	TUBE
\$19.68	KQG2H11-N02S	1/4" NPT	3/8"
\$25.43	KQG2H13-N03S	3/8" NPT	1/2"



KQG2 SERIES MALE ELBOW SMC PNEUMATICS

- 316 Stainless steel construction
- 1/2" Tubing x 3/8" NPT
- FMK seal material • Grease-Free
- Compact and lightweight

PRICE	KR #	SMC #
\$49.76	KQG2L13-N03S	KQG2L13-N03S



HOSES & FITTINGS



PARKER TRUE SEAL FITTINGS

• Max PSI: 300 • Temp Range: -20°F TO 180°F



FEMALE CONNECTOR
(TUBE X FIP)
PARKER TRUE SEAL FITTINGS

PRICE	PART #	TUBE	FIP
\$2.85	PTS4FC4	1/4"	1/4"
\$3.27	PTS6FC4	3/8"	1/4"



SHUT-OFF VALVE
(TUBE X TUBE)
PARKER TRUE SEAL FITTINGS

PRICE	PART #	TUBE
\$5.91	PTS4SV	1/4"
\$5.71	PTS6SV	3/8"



SHUT-OFF VALVE
(TUBE X MIP)
PARKER TRUE SEAL FITTINGS

PRICE	PART #	TUBE	MIP
\$5.56	PTSSV4T4M	1/4"	1/4"
\$5.30	PTSSV6T6M	3/8"	3/8"



END STOP
PARKER TRUE SEAL FITTINGS

PRICE	PART #	TUBE
\$2.83	PTS4ES	1/4"
\$3.65	PTS6ES	3/8"



REDUCER
PARKER TRUE SEAL FITTINGS

PRICE	PART #	TUBE	STEM
\$1.88	PTS6R4	3/8"	1/4"
\$3.62	PTS8R6	1/2"	3/8"



PLUG FOR TUBE CONNECTOR
PARKER TRUE SEAL FITTINGS

PRICE	PART #	TUBE
\$0.59	PTS4P	1/4"
\$0.92	PTS6P	3/8"



UNION CONNECTOR
(TUBE X TUBE)
PARKER TRUE SEAL FITTINGS

PRICE	PART #	TUBE
\$2.16	PTS4UC4	1/4"
\$4.34	PTS5UC5	5/16"
\$2.47	PTS6UC6	3/8"
\$3.22	PTS8UC8	1/2"



FIXED ELBOW
(MIP X TUBE)
PARKER TRUE SEAL FITTINGS

PRICE	PART #	TUBE	MIP
\$1.84	PTS4ME2	1/4"	1/8"
\$2.07	PTS4ME4	1/4"	1/4"
\$2.47	PTS4ME6	1/4"	3/8"
\$3.40	PTS6ME6	3/8"	3/8"



SWIVEL ELBOW
(MIP X TUBE)
PARKER TRUE SEAL FITTINGS

PRICE	PART #	TUBE	MIP
\$2.97	PTS4SE4	1/4"	1/4"
\$7.17	PTS5SE4	5/16"	1/4"
\$4.15	PTS6SE4	3/8"	1/4"
\$4.34	PTS6SE6	3/8"	3/8"



UNION ELBOW
(TUBE X TUBE)
PARKER TRUE SEAL FITTINGS

PRICE	PART #	TUBE
\$2.08	PTS4EL	1/4"
\$3.09	PTS6EL	3/8"
\$3.73	PTS8EL	1/2"



UNION TEE
(TUBE X TUBE X TUBE)
PARKER TRUE SEAL FITTINGS

PRICE	PART #	TUBE
\$3.15	PTS4UT	1/4"
\$3.97	PTS6UT	3/8"
\$4.43	PTS8UT	1/2"



HOSE BARB
(TUBE X BARB)
PARKER TRUE SEAL FITTINGS

PRICE	PART #	TUBE	BARB
\$1.35	PTS4T4H	1/4"	1/4"
\$1.76	PTS6T4H	3/8"	1/4"
\$2.01	PTS6T6H	3/8"	3/8"



BULKHEAD UNION
(TUBE X MIP)
PARKER TRUE SEAL FITTINGS

PRICE	PART #	TUBE	MIP
\$3.58	PTS4BU	1/4"	1/4"
\$5.51	PTS6BU	3/8"	3/8"



SWIVEL BRANCH TEE
(MIP X TUBE X TUBE)
PARKER TRUE SEAL FITTINGS

PRICE	PART #	TUBE	MIP
\$3.71	PTS4MT2	1/4"	1/8"
\$3.95	PTS4MT4	1/4"	1/4"



REDUCING ELBOW
(TUBE X TUBE)
PARKER TRUE SEAL FITTINGS

PRICE	PART #	TUBE	TUBE
\$3.44	PTS6RE4	3/8"	1/4"



MALE CONNECTOR
(TUBE X MIP)
PARKER TRUE SEAL FITTINGS

PRICE	PART #	TUBE	MIP
\$1.26	PTS4MC2	1/4"	1/8"
\$1.35	PTS4MC4	1/4"	1/4"
\$2.38	PTS4MC6	1/4"	3/8"
\$1.98	PTS6MC4	3/8"	1/4"
\$2.42	PTS6MC6	3/8"	3/8"
\$3.10	PTS8MC6	1/2"	3/8"
\$3.35	PTS8MC8	1/2"	1/2"



STEM ADAPTER
(TUBE X MIP)
PARKER TRUE SEAL FITTINGS

PRICE	PART #	TUBE	MIP
\$0.69	PTS4SA2	1/4"	1/8"
\$0.71	PTS4SA4	1/4"	1/4"
\$0.87	PTS6SA4	3/8"	1/4"
\$1.03	PTS6SA6	3/8"	3/8"
\$1.76	PTS8SA6	1/2"	3/8"
\$1.86	PTS8SA8	1/2"	1/2"



CROSS
(TUBE X TUBE X TUBE)
PARKER TRUE SEAL FITTINGS

PRICE	PART #	TUBE
\$5.98	PTS6CR	3/8"



STEM PLUG IN ELBOW
(TUBE X STEM)
PARKER TRUE SEAL FITTINGS

PRICE	PART #	TUBE	STEM
\$1.88	PTS4PIE4	1/4"	1/4"
\$2.44	PTS4PIE6	1/4"	3/8"
\$2.79	PTS6PIE4	3/8"	1/4"
\$3.16	PTS6PIE6	3/8"	3/8"



Since 1924, Parker Hannifin Corporation has served the marketplace with dependable fluid power technology. Much of that expertise originates with Parker's precision-made tube fittings, which were among the first products manufactured by the company. As such, they reflect Parker's ongoing commitment to excellence.

HOSES & FITTINGS

BANJO FITTINGS

IDEAL FOR USE IN PRESSURE WASHING APPLICATIONS



CAMLOCK
3/4" F COUPLER
x 1/2" F THREAD
BANJO

\$12.35 BJ-050D
California WARNING PROPOSITION 65



3/4" F x 1/2" M
CAM & GROOVE
BANJO

\$14.82 BJ-75B1/2
California WARNING PROPOSITION 65



2" F x 2" FNPT
CAM LEVER
BANJO

\$17.56 BJ-200D



POLY 90° STREET ELBOW
BANJO

PRICE	PART #	SIZE
\$9.62	BJ-SL150-90	1 1/2"
\$6.78	BJ-SL125-90	1 1/4"

California WARNING PROPOSITION 65



1/2" 90° POLY ELBOW
BANJO

\$4.49 BJ-EL050-90
California WARNING PROPOSITION 65



90° POLY HOSE BARB
1/2" MPT x 1/2" HB
BANJO

\$1.69 BJ-HB050-90
California WARNING PROPOSITION 65



1 1/4" POLY PIPE COUPLING
BANJO

\$7.82 BJ-CPLG125
California WARNING PROPOSITION 65



6" VENTED TANK LID
BANJO

\$18.25 BJ-TL600C
California WARNING PROPOSITION 65



1 1/4" T-BOLT STAINLESS
HOSE CLAMP
BANJO

PRICE	PART #	DIA.
\$9.79	BJ-TC162	1.62" - 1.87"
\$9.34	BJ-TC130	1.30" - 1.70"

California WARNING PROPOSITION 65



POLY NIPPLE
BANJO

PRICE	PART #	SIZE
\$9.42	BJ-NIP150-4	1 1/2" x 4"
\$9.11	BJ-NIP200-4	2" x 4"

California WARNING PROPOSITION 65



1 1/2" x 3" POLY NIPPLE
BANJO

\$5.65 BJ-NIP150-3
California WARNING PROPOSITION 65



1/2" x 1/2"
SHORT POLY NIPPLE
BANJO

\$1.92 BJ-NIP050-SH
California WARNING PROPOSITION 65



POLY STRAIGHT HOSE BARBS
BANJO

PRICE	PART #	SIZE
\$1.77	BJ-HB100	1" MPT x 1" HB
\$2.54	BJ-HB125	1 1/4" MPT x 1 1/4" HB
\$3.54	BJ-HB150	1 1/2" MPT x 1 1/2" HB
\$4.50	BJ-HB200	2" MPT x 2" HB
\$1.29	BJ-HB050	1/2" MPT x 1/2" HB
\$1.57	BJ-HB050-038	1/2" MPT x 3/8" HB
\$1.69	BJ-HB050-075	1/2" MPT x 3/4" HB

California WARNING PROPOSITION 65



3/4" M x 1/2" HS SHANK
CAM & GROOVE
FITTING
BANJO

\$5.83 BJ-050E
California WARNING PROPOSITION 65



POLY REDUCER NIPPLE
BANJO

PRICE	PART #	SIZE
\$3.69	BJ-RN125-075	1 1/4" x 3/4"
\$3.32	BJ-RN125-100	1 1/4" x 1"

California WARNING PROPOSITION 65



Y STRAINER WITH STAINLESS STEEL SCREEN
BANJO

PRICE	PART #	SIZE	SCREEN
\$42.57	BJ-LS100-40	1"	40 Mesh
\$42.00	BJ-LS125-40	1 1/4"	40 Mesh
\$88.10	BJ-LS150-50	1 1/2"	50 Mesh
\$84.03	BJ-LS200-50	2"	50 Mesh

California WARNING PROPOSITION 65



BULKHEAD FITTINGS WITH EPDM GASKET
BANJO

PRICE	PART #	SIZE	HOLE
\$9.99	BJ-TF075	3/4"	1 5/8"
\$13.57	BJ-TF100	1"	2 1/4"
\$15.34	BJ-TF125	1 1/4"	2 3/4"
\$23.58	BJ-TF150	1 1/2"	3"
\$23.58	BJ-TF200	2"	3"

California WARNING PROPOSITION 65

HOSES & FITTINGS

BANJO FITTINGS

IDEAL FOR USE IN PRESSURE WASHING APPLICATIONS



2" M x 2" MNPT CAM AND GROOVE FITTING
BANJO

\$7.40	BJ-200F



2" PLUG x 2" FEMALE COUPLER
BANJO

\$7.35	BJ-200PL



NICKEL PLATED PUSHLOCKS & POLY-TUBE FITTINGS



FIXED MALE ELBOW
ALPHA TECHNOLOGIES

PRICE	PART #	TUBE	MPT
\$4.80	AL4ME2	1/4"	1/8"
\$5.24	AL4ME4	1/4"	1/4"
\$8.95	AL6ME6	3/8"	3/8"
\$8.29	AL6ME4	3/8"	1/4"



SWIVEL MALE ELBOW
ALPHA TECHNOLOGIES

PRICE	PART #	TUBE	MPT
\$6.64	AL4SE4	1/4"	1/4"
\$10.70	AL6SE6	3/8"	3/8"



UNION ELBOW
ALPHA TECHNOLOGIES

PRICE	PART #	TUBE
\$6.69	AL4EL4	1/4"



STRAIGHT MALE CONNECTOR
ALPHA TECHNOLOGIES

PRICE	PART #	TUBE	PIPE
\$4.11	AL4MC4	1/4"	1/4"
\$5.24	AL4MC6	1/4"	3/8"
\$5.95	AL6MC2	3/8"	1/8"
\$5.55	AL6MC4	3/8"	1/4"
\$6.17	AL6MC6	3/8"	3/8"



UNION CONNECTOR
ALPHA TECHNOLOGIES

PRICE	PART #	TUBE
\$5.58	AL4UC4	1/4"
\$8.31	AL6UC6	3/8"



STRAIGHT FEMALE CONNECTOR
ALPHA TECHNOLOGIES

PRICE	PART #	TUBE	MPT
\$8.31	AL4FC4	1/4"	1/4"
\$14.16	AL6FC4	3/8"	1/4"
\$13.88	AL6FC6	3/8"	3/8"



UNION TEE
ALPHA TECHNOLOGIES

PRICE	PART #	TUBE
\$8.95	AL4UT	1/4"
\$12.34	AL6UT	3/8"



SWIVEL MALE BRANCH TEE
ALPHA TECHNOLOGIES

PRICE	PART #	TUBE	MPT
\$9.89	AL4MT4	1/4"	1/4"
\$13.61	AL6MT4	3/8"	1/4"



ALPHA FITTINGS PUSH-TO-CONNECT SWIFT-FIT FITTINGS USE AN INTERNAL COLLET AND EXTERNAL PUSH BUTTON TO CONNECT TUBING.

made from nickel-plated brass for long-lasting durability. Features Buna seal. Compatible with nylon, polyethylene, polyurethane and copper tubing for increased versatility. Corrosion-resistant.

HOSES & FITTINGS

STAINLESS STEEL FITTINGS



CROSS FITTING STAINLESS STEEL FITTINGS

- Pressure Rating: 3000 PSI • Ends: FPT
- Construction: 304 Stainless Steel

\$88.73	SSF100-4	1/4"
\$132.31	SSF100-6	3/8"



90° STREET ELBOW STAINLESS STEEL FITTINGS

- Pressure Rating: 3000 PSI • Ends: MPT x FPT
- Construction: 304 Stainless Steel

\$24.87	SSF105-44	1/4"	\$48.37	SSF105-1212	3/4"
\$25.47	SSF105-66	3/8"	\$83.68	SSF105-1616	1"
\$30.69	SSF105-88	1/2"			



COUPLING STAINLESS STEEL FITTINGS

- Pressure Rating: 3000 PSI • Ends: FPT x FPT
- Construction: 304 Stainless Steel

\$10.53	SSF110-4	1/4"	\$12.06	SSF110-12	3/4"
\$10.47	SSF110-6	3/8"	\$32.19	SSF110-16	1"
\$15.68	SSF110-8	1/2"	\$12.34	SSF110-20	1 1/4"



BUSHING STAINLESS STEEL FITTINGS

- Pressure Rating: 3000 PSI • Ends: MPT x FPT
- Construction: 304 Stainless Steel

\$8.20	SSF130-64	3/8" x 1/4"	\$34.40	SSF130-1612	1" x 3/4"
\$10.85	SSF130-86	1/2" x 3/8"	\$18.45	SSF130-2016	1 1/4" x 1"
\$17.71	SSF130-128	3/4" x 1/2"	\$42.88	SSF130-2416	1 1/2" x 1"



90° ELBOW STAINLESS STEEL FITTINGS

- Pressure Rating: 3000 PSI
- Construction: 304 Stainless Steel
- Ends: FPT x FPT

\$13.97	SSF115-4	1/4"	\$85.83	SSF115-16	1"
\$27.58	SSF115-6	3/8"	\$84.83	SSF115-20	1 1/4"
\$22.72	SSF115-8	1/2"	\$159.00	SSF115-24	1 1/2"
\$51.85	SSF115-12	3/4"			



TEE STAINLESS STEEL FITTINGS

- Pressure Rating: 3000 PSI
- Construction: 304 Stainless Steel
- Ends: FPT x FPT

\$23.89	SSF120-4	1/4"	\$71.26	SSF120-12	3/4"
\$35.21	SSF120-6	3/8"	\$118.17	SSF120-20	1 1/4"
\$38.30	SSF120-8	1/2"	\$188.76	SSF120-24	1 1/2"



HEX HEAD PLUG STAINLESS STEEL FITTINGS

- Pressure Rating: 3000 PSI
- Construction: 304 Stainless Steel
- Ends: MPT

\$4.59	SSF125-4	1/4"	\$11.35	SSF125-12	3/4"
\$5.95	SSF125-6	3/8"	\$120.07	SSF125-32	2"
\$7.50	SSF125-8	1/2"			



SWIVEL UNION STAINLESS STEEL FITTINGS

- Construction: 304 Stainless Steel

PRICE	PART #	SIZE	PSI
\$10.03	140444SS	1/4" M x 1/4" F	5000
\$27.80	140446SS	1/4" M x 3/8" F	5000
\$16.57	140466SS	3/8" M x 3/8" F	4000
\$12.84	140566SS	3/8" F x 3/8" F	4000
\$27.90	140468SS	3/8" M x 1/2" F	4000
\$20.11	140488SS	1/2" M x 1/2" F	3000
\$20.00	140588SS	1/2" F x 1/2" F	3000
\$38.96	14041212SS	3/4" M x 3/4" F	3000
\$53.49	14041616SS	1" M x 1" F	2000



NIPPLE STAINLESS STEEL FITTINGS

PRICE	PART #	MPT	PSI	LENGTH	SS TYPE
\$9.77	SSF135-2	1/8"	3000	Close	304
\$13.70	SSF135-2-2	1/8"	3000	2"	304
\$6.77	SSF135-2-4	1/8"	3000	4"	304
\$2.97	SSF135-4	1/4"	3000	Close	304
\$4.48	SSF135-4-2	1/4"	3000	2"	304
\$7.76	SSF135-4-4	1/4"	3000	4"	304
\$11.03	SSF135-4-6	1/4"	3000	6"	304
\$3.57	SSF135-6	3/8"	3000	Close	304
\$5.27	SSF135-6-2	3/8"	3000	2"	304
\$9.46	SSF135-6-4	3/8"	3000	4"	304
\$14.25	SSF135-6-6	3/8"	3000	6"	304
\$4.60	SSF135-8	1/2"	3000	Close	304
\$6.68	SSF135-8-2	1/2"	3000	2"	304
\$11.98	SSF135-8-4	1/2"	3000	4"	304
\$61.75	SSF135-8-6	1/2"	3000	6"	304
\$6.84	SSF135-12	3/4"	3000	Close	304
\$8.74	SSF135-12-2	3/4"	3000	2"	304
\$15.77	SSF135-12-4	3/4"	3000	4"	304
\$29.25	SSF135-16	1"	3000	Close	304
\$12.59	SSF135-16-2	1"	3000	2"	304

PRICE	PART #	MPT	PSI	LENGTH	SS TYPE
\$5.39	SSF140-16	1"	3000	Close	316
\$25.39	SSF140-16-2	1"	3000	2"	316
\$15.61	SSF140-16-4	1"	3000	4"	316
\$71.37	SSF140-16-6	1"	3000	6"	316
\$18.99	SSF140-20	1 1/4"	3000	Close	316
\$62.88	SSF140-20-4	1 1/4"	3000	4"	316
\$25.37	SSF140-24	1 1/2"	3000	Close	316
\$47.65	SSF140-24-4	1 1/2"	3000	4"	316
\$69.32	SSF140-24-6	1 1/2"	3000	6"	316
\$42.50	SSF140-32	2"	3000	Close	316
\$83.43	SSF140-32-4	2"	3000	4"	316
\$141.47	SSF140-32-6	2"	3000	6"	316
\$136.79	SSF140-48	3"	3000	Close	316
\$5.75	SSF145-4	1/4"	5000	Close	316
\$15.23	SSF145-4-2	1/4"	5000	2"	316
\$11.58	SSF145-6	3/8"	4000	Close	316
\$60.88	SSF145-6-2	3/8"	4000	2"	316
\$3.50	SSF145-8-2	1/2"	3000	2"	316
\$31.91	SSF145-8-3	1/2"	3000	3"	316
\$20.90	SSF145-12	3/4"	3000	Close	316

HOSES & FITTINGS

KLEEN-RITE CORP.

KLEEN-RITE PUSH-IN FITTINGS & CONNECTORS



UNION CONNECTORS

KLEEN-RITE POLY-TUBE & PUSH-IN FITTINGS

PRICE	PART #	SIZE
\$6.96	HF0500	1/4"
\$9.65	HF0501	3/8"
\$9.54	HF0550	3/8" x 1/4"
\$14.35	HF0551	1/2"

California WARNING PROPOSITION 65



FEMALE CONNECTORS

KLEEN-RITE POLY-TUBE & PUSH-IN FITTINGS

PRICE	PART #	SIZE
\$14.66	HF0508	3/8" x 1/4"
\$10.35	HF0519	1/4"
\$10.57	HF0553	3/8"

California WARNING PROPOSITION 65



FIXED MALE ELBOWS

KLEEN-RITE POLY-TUBE & PUSH-IN FITTINGS

PRICE	PART #	SIZE
\$5.87	HF0540	1/4"
\$11.45	HF0541	3/8"
\$6.79	HF0542	3/8" x 1/4"
\$5.18	HF0543	1/4" x 1/8"
\$11.62	HF0554	1/4" x 3/8"

California WARNING PROPOSITION 65



UNION ELBOWS

KLEEN-RITE POLY-TUBE & PUSH-IN FITTINGS

PRICE	PART #	SIZE
\$8.18	HF0530	1/4"
\$13.38	HF0560	3/8"
\$18.91	HF0561	1/2"

California WARNING PROPOSITION 65



BRASS & NICKEL PLATED PUSH-IN RUN TEE SWIVEL

KLEEN-RITE PUSH-IN FITTINGS

PRICE	PART #	SIZE
\$10.54	AL4ST4	1/4" O.D. x 1/4" M
\$18.46	AL6ST6	3/8" O.D. x 3/8" M

California WARNING PROPOSITION 65

New!



BRASS PUSH-IN CONNECTOR

KLEEN-RITE PUSH-IN FITTINGS

PRICE	PART #	SIZE
\$13.72	HF0502	1/2" OD x 1/2" M NPTF



MALE CONNECTORS

KLEEN-RITE POLY-TUBE & PUSH-IN FITTINGS

PRICE	PART #	SIZE
\$5.29	HF0503	1/4" x 1/4"
\$6.84	HF0504	3/8" x 1/4"
\$7.30	HF0505	3/8"
\$6.46	HF0506	1/4" x 3/8"
\$6.31	HF0507	3/8" x 1/8"
\$4.54	HF0556	1/4" x 1/8"
\$9.62	HF0557	1/2" x 1/4"

California WARNING PROPOSITION 65



BRANCH SWIVEL TEES

KLEEN-RITE POLY-TUBE & PUSH-IN FITTINGS

PRICE	PART #	SIZE
\$9.95	HF0520	1/4"
\$13.33	HF0521	3/8" x 1/4"
\$21.43	HF0562	3/8"

California WARNING PROPOSITION 65



COMPRESSION UNION ELBOW FITTING

KLEEN-RITE POLY-TUBE & PUSH-IN FITTINGS

PRICE	PART #	SIZE
\$3.52	FTC04E	1/4" FNPT



COMPRESSION TEE FITTING FOR SONNY'S AUTOMATICS

KLEEN-RITE CORP.

PRICE	PART #	SIZE
\$8.48	FTC04T	1/4" FNPT



SWIVEL MALE ELBOWS

KLEEN-RITE POLY-TUBE & PUSH-IN FITTINGS

PRICE	PART #	SIZE
\$6.81	HF0535	1/4"
\$8.72	HF0545	3/8"
\$15.59	HF0558	1/4" x 3/8" M
\$7.63	HF0544	3/8" x 1/4" M
\$14.30	HF0559	1/2" x 3/8" M

California WARNING PROPOSITION 65



STEEL HYDRAULIC REDUCER

KLEEN-RITE CORP. BUSHING

PRICE	PART #	SIZE
\$2.52	5406-12-8	3/4" MPT x 1/2" FPT

HOSES & FITTINGS

HOSE ADAPTERS - NON-WORKING SWIVELS



New!

90° STREET ELBOW KLEEN-RITE

- Max Pressure:
5502-04-04 = 4000 PSI
5502-06-06 = 3000 PSI

PRICE	PART #	SIZE
\$3.95	5502-04-04	1/4" MPT x FPT
\$5.00	5502-06-06	3/8" MPT x FPT



New!

90° MALE ELBOW KLEEN-RITE

- Max Pressure: 3000 PSI
- Hardened stainless steel construction means this fitting is sure to last

PRICE	PART #	SIZE
\$5.06	5500-06-06	3/8" MPT x MPT



New!

45° STREET ELBOW KLEEN-RITE

- Max Pressure: 4000 PSI
- A great choice for hydraulic and high-pressure wash applications

PRICE	PART #	SIZE
\$4.26	5503-04-04	1/4" MPT x FPT



New!

1/4" MxM FITTING KLEEN-RITE

- Max Pressure: 4000 PSI
- Used to connect car wash piping

PRICE	PART #	SIZE
\$1.65	5404-04-04	1/4" x 1/4"



2 1

1501-90° HOSE ADAPTERS - NON-WORKING SWIVELS



- (1) Male pipe
- (2) Female pipe swivel

PRICE	PART #	SIZE (M X F)	PRICE	PART #	SIZE (M X F)
\$3.29	150144	1/4" x 1/4"	\$5.91	150188	1/2" x 1/2"
\$5.37	150164	3/8" x 1/4"	\$9.77	1501128	3/4" x 1/2"
\$4.51	150166	3/8" x 3/8"	\$9.21	15011212	3/4" x 3/4"
\$6.46	150184	1/2" x 1/4"	\$11.06	15011616	1" x 1"
\$5.82	150186	1/2" x 3/8"			



1

1502-90° HOSE ADAPTERS - NON-WORKING SWIVELS



- (1) Female pipe
- (2) Female pipe swivel

PRICE	PART #	SIZE (F X F)	PRICE	PART #	SIZE (F X F)
\$5.14	150244	1/4" x 1/4"	\$14.46	1502128	3/4" x 1/2"
\$4.06	150266	3/8" x 3/8"	\$12.05	15021212	3/4" x 3/4"
\$5.26	150286	1/2" x 3/8"	\$28.68	15021616	1" x 1"
\$2.15	150288	1/2" x 1/2"			



1

1504-45° HOSE ADAPTERS - NON-WORKING SWIVELS



- (1) Female pipe
- (2) Female pipe swivel

PRICE	PART #	SIZE (F X F)	PRICE	PART #	SIZE (F X F)
\$4.93	150444	1/4" x 1/4"	\$13.54	15041212	3/4" x 3/4"
\$7.90	150466	3/8" x 3/8"	\$22.94	15041616	1" x 1"
\$8.80	150488	1/2" x 1/2"			



1

1503-45° HOSE ADAPTERS - NON-WORKING SWIVELS



- (1) Male pipe
- (2) Female pipe swivel

PRICE	PART #	SIZE (M X F)	PRICE	PART #	SIZE (M X F)
\$3.21	150344	1/4" x 1/4"	\$9.94	150386	1/2" x 3/8"
\$6.57	150346	1/4" x 3/8"	\$6.86	150388	1/2" x 1/2"
\$5.37	150364	3/8" x 1/4"	\$2.95	1503128	3/4" x 1/2"
\$5.10	150366	3/8" x 3/8"	\$9.39	15031212	3/4" x 3/4"



1

1405-STRAIGHT HOSE ADAPTERS - NON-WORKING SWIVELS



- (1) Female pipe
- (2) Female pipe swivel

PRICE	PART #	SIZE (F X F)	PRICE	PART #	SIZE (F X F)
\$2.98	140544	1/4" x 1/4"	\$4.33	140586	1/2" x 3/8"
\$3.14	140546	1/4" x 3/8"	\$3.58	140588	1/2" x 1/2"
\$2.68	140564	3/8" x 1/4"	\$4.83	14051212	3/4" x 3/4"
\$3.02	140566	3/8" x 3/8"	\$7.43	14051616	1" x 1"
\$3.43	140568	3/8" x 1/2"			



1

1404-STRAIGHT HOSE ADAPTERS - NON-WORKING SWIVELS



- (1) Male pipe
- (2) Female pipe swivel

PRICE	PART #	SIZE (M X F)	PRICE	PART #	SIZE (M X F)
\$1.58	140444	1/4" x 1/4"	\$5.30	14040812	1/2" x 3/4"
\$2.98	140446	1/4" x 3/8"	\$6.86	1404128	3/4" x 1/2"
\$1.75	140464	3/8" x 1/4"	\$4.46	14041212	3/4" x 3/4"
\$3.32	140466	3/8" x 3/8"	\$10.35	14041216	3/4" x 1"
\$3.06	140468	3/8" x 1/2"	\$9.94	14041612	1" x 3/4"
\$4.35	140486	1/2" x 3/8"	\$7.93	14041616	1" x 1"
\$3.07	140488	1/2" x 1/2"			



1

1603-TEE HOSE ADAPTERS - NON-WORKING SWIVELS



- (1) Female pipe
- (2) Female pipe swivel
- (3) Female pipe swivel

PRICE	PART #	SIZE (F X F X F)
\$10.77	1603444	1/4" x 1/4" x 1/4"
\$13.37	1603666	3/8" x 3/8" x 3/8"
\$15.00	1603888	1/2" x 1/2" x 1/2"



1

1601-TEE HOSE ADAPTERS - NON-WORKING SWIVELS



- (1) Male pipe
- (2) Female pipe swivel
- (3) Female pipe swivel

PRICE	PART #	SIZE (M X F X F)
\$6.25	1601444	1/4" x 1/4" x 1/4"
\$11.57	1601666	3/8" x 3/8" x 3/8"
\$16.89	1601888	1/2" x 1/2" x 1/2"

HOSES & FITTINGS

PUSH LOCK FITTINGS

PUSH LOCK FITTINGS

HOSES & FITTINGS

- Easy to use. No hose clamps or ferrules are needed. For use with push-on hose only; the end of the hose is concealed by the plastic cap. Made from free-cutting CA.



PUSH LOCK BARB

PUSH LOCK FITTINGS

PRICE	PART #	SIZE	PRICE	PART #	SIZE
\$1.20	PLF220	1/4" x 1/8" F	\$3.54	PLF225	3/8" x 3/8"
\$2.13	PLF221	1/4" x 1/4" F	\$4.04	PLF226	1/2" x 3/8"
\$2.48	PLF224	3/8" x 1/4"	\$6.90	PLF227	1/2" x 1/2"



37° JIC FLARE FEMALE SWIVEL

PUSH LOCK FITTINGS

PRICE	PART #	SIZE	PRICE	PART #	SIZE
\$4.37	PLF264	1/4" x 3/8"	\$5.50	PLF267	1/2" x 1/2"
\$2.25	PLF265	1/4" x 1/4"	\$7.09	PLF268	5/8" x 5/8"
\$3.56	PLF266	3/8" x 3/8"	\$9.84	PLF269	3/4" x 3/4"



HOSE BARB SPLICER

PUSH LOCK FITTINGS

PRICE	PART #	SIZE	PRICE	PART #	SIZE
\$1.73	PLF300	1/4"	\$7.54	PLF303	5/8"
\$2.15	PLF301	3/8"	\$7.89	PLF304	3/4"
\$3.29	PLF302	1/2"	\$2.88	PLF305	5/16"



PUSH BARB SWIVEL

PUSH LOCK FITTINGS

PRICE	PART #	HOSE ID X NPTF	PRICE	PART #	HOSE ID X NPTF
\$5.42	PLF385	1/4" x 1/4"	\$6.60	PLF388	1/2" x 3/8"
\$6.24	PLF386	3/8" x 1/4"	\$8.95	PLF389	1/2" x 1/2"
\$7.00	PLF387	3/8" x 3/8"			



45° SAE FLARE FEMALE SWIVEL

PUSH LOCK FITTINGS

PRICE	PART #	HOSE I.D. X OD TUBE	PRICE	PART #	HOSE I.D. X OD TUBE
\$2.68	PLF250	1/4" x 1/4"	\$9.93	PLF257	3/8" x 1/2"
\$4.25	PLF251	1/4" x 5/16"	\$11.65	PLF258	5/8" x 5/8"
\$3.83	PLF252	3/8" x 3/8"	\$10.26	PLF259	3/4" x 3/4"
\$3.93	PLF253	1/4" x 3/8"	\$7.89	PLF261	1/2" x 3/8"
\$6.28	PLF255	1/2" x 1/2"			



FEMALE DEAD SWIVEL

PUSH LOCK FITTINGS

PRICE	PART #	HOSE I.D. X BALLSEAT PIPE	PRICE	PART #	HOSE I.D. X BALLSEAT PIPE
\$7.80	PLF341	1/4" x 1/4"	\$15.61	PLF346	1/2" x 1/2"
\$11.48	PLF343	3/8" x 1/4"	\$22.30	PLF349	3/4" x 3/4"
\$10.60	PLF344	3/8" x 3/8"			



MALE SAE FLARE ADAPTER

PUSH LOCK FITTINGS

PRICE	PART #	HOSE I.D. X OD TUBE	PRICE	PART #	HOSE I.D. X OD TUBE
\$4.31	PLF243	3/8" x 3/8"	\$4.02	PLF245	1/2" x 1/2"



MALE ELBOW

PUSH LOCK FITTINGS

PRICE	PART #	HOSE ID X MIP	PRICE	PART #	HOSE ID X MIP
\$7.97	PLF372	1/4" x 1/8"	\$5.68	PLF376	3/8" x 3/8"
\$7.66	PLF373	1/4" x 1/4"	\$20.00	PLF377	3/8" x 1/2"
\$5.15	PLF371	3/8" x 1/4"	\$12.34	PLF378	1/2" x 1/2"



PUSH LOCK BARB

PUSH LOCK FITTINGS

PRICE	PART #	HOSE I.D. X I.P.T.	PRICE	PART #	HOSE I.D. X I.P.T.	PRICE	PART #	HOSE I.D. X I.P.T.
\$1.41	PLF200	1/4" x 1/8"	\$2.83	PLF206	1/2" x 3/8"	\$3.07	PLF213	5/16" x 1/4"
\$1.96	PLF201	1/4" x 1/4"	\$4.70	PLF207	1/2" x 1/2"	\$7.97	PLF215	3/4" x 1/2"
\$2.13	PLF202	3/8" x 1/8"	\$6.56	PLF209	5/8" x 1/2"	\$2.88	PLF216	1/2" x 1/4"
\$2.25	PLF203	3/8" x 1/4"	\$7.54	PLF210	3/4" x 3/4"	\$7.01	PLF217	1/2" x 3/4"
\$2.73	PLF204	3/8" x 3/8"	\$2.88	PLF211	1/4" x 3/8"			
\$4.87	PLF205	3/8" x 1/2"						

HOSES & FITTINGS

BARSTOCK FITTINGS

LONG PIPE NIPPLE

BARSTOCK FITTINGS

PART #	SIZE	PART #	SIZE	PART #	SIZE	PART #	SIZE
BFN113-122	3/4" x 2"	BFN113-46	1/4" x 6"	BFN113-64	3/8" x 4"	BFN113-825	1/2" x 2 1/2"
BFN113-22	1/8" x 2"	BFN113-615	3/8" x 1 1/2"	BFN113-645	3/8" x 4 1/2"	BFN113-83	1/2" x 3"
BFN113-415	1/4" x 1 1/2"	BFN113-62	3/8" x 2"	BFN113-65	3/8" x 5"	BFN113-835	1/2" x 3 1/2"
BFN113-42	1/4" x 2"	BFN113-625	3/8" x 2 1/2"	BFN113-655	3/8" x 5 1/2"	BFN113-84	1/2" x 4"
BFN113-425	1/4" x 2 1/2"	BFN113-63	3/8" x 3"	BFN113-66	3/8" x 6"	BFN113-85	1/2" x 5"
BFN113-43	1/4" x 3"	BFN113-635	3/8" x 3 1/2"	BFN113-815	1/2" x 1 1/2"	BFN113-86	1/2" x 6"
BFN113-435	1/4" x 3 1/2"	BFN113-44	1/4" x 4"	BFN113-82	1/2" x 2"		



HOSE TO MALE PIPE

BARSTOCK FITTINGS

PART #	SIZE	PART #	SIZE	PART #	SIZE	PART #	SIZE
BFA29-22	1/8" x 1/8"	BFA29-46	1/4" x 3/8"	BFA29-612	3/8" x 3/4"	BFA29-108	5/8" x 1/2"
BFA29-24	1/8" x 1/4"	BFA29-48	1/4" x 1/2"	BFA29-84	1/2" x 1/4"	BFA29-128	3/4" x 1/2"
BFA29-32	3/16" x 1/8"	BFA29-62	3/8" x 1/8"	BFA29-86	1/2" x 3/8"	BFA29-1212	3/4" x 3/4"
BFA29-34	3/16" x 1/4"	BFA29-64	3/8" x 1/4"	BFA29-88	1/2" x 1/2"	BFA29-1612	1" x 3/4"
BFA29-42	1/4" x 1/8"	BFA29-66	3/8" x 3/8"	BFA29-812	1/2" x 3/4"	BFA29-1616	1" x 1"
BFA29-44	1/4" x 1/4"	BFA29-68	3/8" x 1/2"	BFA29-106	5/8" x 3/8"		



MALE x FEMALE PIPE BUSHING

BARSTOCK FITTINGS

PART #	SIZE	PART #	SIZE	PART #	SIZE	PART #	SIZE
BFA110-42	1/4" x 1/8"	BFA110-84	1/2" x 1/4"	BFA110-124	3/4" x 1/4"	BFA110-166	1" x 3/8"
BFA110-62	3/8" x 1/8"	BFA110-86	1/2" x 3/8"	BFA110-126	3/4" x 3/8"	BFA110-168	1" x 1/2"
BFA110-64	3/8" x 1/4"	BFA110-122	3/4" x 1/8"	BFA110-128	3/4" x 1/2"	BFA110-1612	1" x 3/4"
BFA110-82	1/2" x 1/8"	BFA110-124	3/4" x 1/4"	BFA110-164	1" x 1/4"		



PIPE UNION

BARSTOCK FITTINGS

PART #	SIZE	PART #	SIZE
BFA104-4	1/4"	BFA104-8	1/2"
BFA104-6	3/8"	BFA104-12	3/4"



CLOSE PIPE NIPPLE

BARSTOCK FITTINGS

PART #	SIZE	PART #	SIZE
BFN112-2	1/8"	BFN112-8	1/2"
BFN112-4	1/4"	BFN112-12	3/4"
BFN112-6	3/8"		



MALE x FEMALE 90° PIPE ELBOW

BARSTOCK FITTINGS

PART #	SIZE	PART #	SIZE
BFA116-2	1/8"	BFA116-8	1/2"
BFA116-4	1/4"	BFA116-12	3/4"
BFA116-6	3/8"		



FEMALE x FEMALE 90° PIPE ELBOW

BARSTOCK FITTINGS

PART #	SIZE	PART #	SIZE
BFE100-2	1/8"	BFA100-8	1/2"
BFA100-6	3/8"	BFA100-4	1/4"



MALE HEX PIPE REDUCER

BARSTOCK FITTINGS

PART #	SIZE	PART #	SIZE
BFA123-42	1/4" x 1/8"	BFA123-84	1/2" x 1/4"
BFA123-62	3/8" x 1/8"	BFA123-86	1/2" x 3/8"
BFA123-64	3/8" x 1/4"	BFA123-128	3/4" x 1/2"



M x M HEX PIPE NIPPLE

BARSTOCK FITTINGS

PART #	SIZE	PART #	SIZE
BFA122-2	1/8"	BFA122-8	1/2"
BFA122-4	1/4"	BFA122-12	3/4"
BFA122-6	3/8"	BFA122-16	1"



45° MALE x FEMALE PIPE STREET ELBOW

BARSTOCK FITTINGS

PART #	SIZE	PART #	SIZE
BFA124-2	1/8"	BFA124-8	1/2"
BFA124-4	1/4"	BFA124-12	3/4"
BFA124-6	3/8"		



HOSE TO HOSE SPLICER

BARSTOCK FITTINGS

PART #	SIZE	PART #	SIZE
BFA29S-2	1/8"	BFA29S-10	5/8"
BFA29S-3	3/16"	BFA29S-8	1/2"
BFA29S-4	1/4"	BFA29S-12	3/4"
BFA29S-6	3/8"		



HOSES & FITTINGS

BARSTOCK FITTINGS



FEMALE PIPE REDUCER
BARSTOCK FITTINGS

PART #	SIZE	PART #	SIZE
BFA119-42	1/4" x 1/8"	BFA119-84	1/2" x 1/4"
BFA119-62	3/8" x 1/8"	BFA119-86	1/2" x 3/8"
BFA119-64	3/8" x 1/4"	BFA119-126	3/4" x 3/8"
BFA119-82	1/2" x 1/8"	BFA119-128	3/4" x 1/2"

California WARNING
PROPOSITION 65



FEMALE x MALE PIPE ADAPTER
BARSTOCK FITTINGS

PART #	SIZE	PART #	SIZE
BFA120-22	1/8" x 1/8"	BFA120-66	3/8" x 3/8"
BFA120-42	1/4" x 1/8"	BFA120-84	1/2" x 1/4"
BFA120-44	1/4" x 1/4"	BFA120-86	1/2" x 3/8"
BFA120-62	3/8" x 1/8"	BFA120-88	1/2" x 1/2"
BFA120-64	3/8" x 1/4"	BFA120-1212	3/4" x 3/4"
		BFA120-128	3/4" x 1/2"

California WARNING
PROPOSITION 65



FEMALE PIPE TEE
BARSTOCK FITTINGS

PART #	SIZE	PART #	SIZE
BFA101-2	1/8"	BFA101-8	1/2"
BFA101-4	1/4"	BFA101-12	3/4"
BFA101-6	3/8"		

California WARNING
PROPOSITION 65



PIPE COUPLING
BARSTOCK FITTINGS

PART #	SIZE	PART #	SIZE
BFA103-2	1/8"	BFA103-8	1/2"
BFA103-4	1/4"	BFA103-12	3/4"
BFA103-6	3/8"		

California WARNING
PROPOSITION 65



MALE SQUARE HEAD PIPE PLUG
BARSTOCK FITTINGS

PART #	SIZE	PART #	SIZE
BFP109-2	1/8"	BFP109-8	1/2"
BFP109-4	1/4"	BFP109-12	3/4"
BFP109-6	3/8"		

California WARNING
PROPOSITION 65



MALE STREET PIPE TEE
BARSTOCK FITTINGS

PART #	SIZE	PART #	SIZE
BFA127-2	1/8"	BFA127-6	3/8"
BFA127-4	1/4"	BFA127-8	1/2"

California WARNING
PROPOSITION 65



MALE BRANCH PIPE TEE
BARSTOCK FITTINGS

PART #	SIZE	PART #	SIZE
BFA131-2	1/8"	BFA131-6	3/8"
BFA131-4	1/4"	BFA131-8	1/2"

California WARNING
PROPOSITION 65



FEMALE PIPE CROSS
BARSTOCK FITTINGS

PART #	SIZE	PART #	SIZE
BFA102-2	1/8"	BFA102-8	1/2"
BFA102-4	1/4"	BFA102-12	3/4"
BFA102-6	3/8"		

California WARNING
PROPOSITION 65

SAE 45° FLARE BRASS BARSTOCK FITTINGS



90° MALE FLARE ELBOW
SAE FITTINGS

PART#	MALE FLARE X MIP	PART#	MALE FLARE X MIP
BFA205-44	1/4" x 1/4"	BFA205-68	3/8" x 1/2"
BFA205-46	1/4" x 3/8"	BFA205-84	1/2" x 1/4"
BFA205-48	1/4" x 1/2"	BFA205-86	1/2" x 3/8"
BFA205-64	3/8" x 1/4"	BFA205-88	1/2" x 1/2"
BFA205-66	3/8" x 3/8"		

California WARNING
PROPOSITION 65



MALE FLARE PIPE ADAPTER
SAE FITTINGS

PART#	FLARE X MALE	PART#	FLARE X MALE
BFA203-44	1/4" x 1/4"	BFA203-68	3/8" x 1/2"
BFA203-46	1/4" x 3/8"	BFA203-86	1/2" x 3/8"
BFA203-64	3/8" x 1/4"	BFA203-88	1/2" x 1/2"
BFA203-66	3/8" x 3/8"	BFA203-1212	3/4" x 3/4"

California WARNING
PROPOSITION 65



MALE FLARE UNION
SAE FITTINGS

PART#	SIZE
BFA200-4	1/4"
BFA200-6	3/8"
BFA200-8	1/2"

California WARNING
PROPOSITION 65



FLARE UNION TEE
SAE FITTINGS

PART#	SIZE
BFA202-4	1/4"
BFA202-6	3/8"
BFA202-8	1/2"

California WARNING
PROPOSITION 65



FORGED 90° MALE FLARE ELBOW
SAE FITTINGS

PART#	SIZE
BFA206-4	1/4"
BFA206-6	3/8"
BFA206-8	1/2"

California WARNING
PROPOSITION 65



FEMALE FLARE PIPE ADAPTER
SAE FITTINGS

PART#	FLARE X FEMALE
BFA204-64	3/8" x 1/4"
BFA204-66	3/8" x 3/8"
BFA204-68	3/8" x 1/2"

California WARNING
PROPOSITION 65



REDUCING FLARE UNION
SAE FITTINGS

PART#	SIZE
BFA201-64	3/8" x 1/4"
BFA201-84	1/2" x 1/4"
BFA201-86	1/2" x 3/8"

California WARNING
PROPOSITION 65

HOSES & FITTINGS



PARKER® FAST & TITE FITTINGS

STRAIGHT MALE CONNECTORS

PARKER FAST & TITE FITTINGS



PRICE	PART #	SIZE	PRICE	PART #	SIZE
\$2.09	FT4MC2	1/4" T x 1/8" M	\$2.96	FT6MC8	3/8" T x 1/2" M
\$2.13	FT4MC4	1/4" T x 1/4" M	\$3.11	FT8MC4	1/2" T x 1/4" M
\$2.64	FT6MC4	3/8" T x 1/4" M	\$3.68	FT8MC6	1/2" T x 3/8" MIP
\$2.73	FT6MC6	3/8" T x 3/8" M	\$3.93	FT8MC8	1/2" T x 1/2" MIP

MALE ELBOWS

PARKER FAST & TITE FITTINGS



PRICE	PART #	SIZE	PRICE	PART #	SIZE
\$3.20	FT4ME2	1/4" T x 1/8" M	\$4.16	FT6ME8	3/8" T x 1/2" M
\$2.76	FT4ME4	1/4" T x 1/4" M	\$5.01	FT8ME4	1/2" T x 1/4" MIP
\$3.26	FT4ME6	1/4" T x 3/8" M	\$4.57	FT8ME6	1/2" T x 3/8" MIP
\$3.68	FT6ME4	3/8" T x 1/4" M	\$4.68	FT8ME8	1/2" T x 1/2" MIP
\$3.77	FT6ME6	3/8" T x 3/8" M			

MALE BRANCH TEE

PARKER FAST & TITE FITTINGS



PRICE	PART #	SIZE
\$5.20	FT6MT4	3/8" T x 1/4" M
\$7.28	FT6MT6	3/8" T x 3/8" M

FEMALE ELBOWS

PARKER FAST & TITE FITTINGS



PRICE	PART #	SIZE
\$5.14	FT6FE6	3/8" T x 3/8" F
\$4.97	FT8FE6	1/2" T x 3/8" F

UNION CONNECTORS

PARKER FAST & TITE FITTINGS



PRICE	PART #	SIZE
\$3.20	FT4UC4	1/4" T x 1/4" T
\$3.74	FT6UC4	3/8" T x 1/4" T
\$4.22	FT6UC6	3/8" T x 3/8" T
\$4.94	FT8UC6	1/2" T x 3/8" T
\$4.94	FT8UC8	1/2" T x 1/2" T

STRAIGHT FEMALE CONNECTORS

PARKER FAST & TITE FITTINGS



PRICE	PART #	SIZE
\$3.45	FT4FC4	1/4" T x 1/4" F
\$3.33	FT6FC4	3/8" T x 1/4" F
\$5.14	FT6FC6	3/8" T x 3/8" F
\$6.79	FT8FC6	1/2" T x 3/8" F

UNION TEE

PARKER FAST & TITE FITTINGS



PRICE	PART #	SIZE
\$6.06	FT4TU4	1/4" T x 1/4" T x 1/4" T
\$6.69	FT6TU6	3/8" T x 3/8" T x 3/8" T
\$9.33	FT8TU8	1/2" T x 1/2" T x 1/2" T

NUT/SLEEVE FITTINGS

MALE ELBOWS

NUT/SLEEVE FITTINGS



PRICE	PART #	SIZE
\$6.71	HF0305	3/8"
\$4.50	HF0306	3/8" x 1/4"
\$3.94	HF0311	1/4"
\$3.60	HF0313	1/4" x 1/8"

MALE CONNECTORS

NUT/SLEEVE FITTINGS



PRICE	PART #	SIZE	PRICE	PART #	SIZE
\$4.62	HF0303	3/8"	\$2.18	HF0312	1/4" x 1/8"
\$3.00	HF0304	3/8" x 1/4"	\$3.11	HF0324	3/8" x 1/8"
\$2.94	HF0310	1/4"	\$11.74	HF0328	1/2"

BRANCH TEES

NUT/SLEEVE FITTINGS



PRICE	PART #	SIZE
\$7.74	HF0308	1/4"
\$5.55	HF0322	1/4" x 1/4" x 1/8" M

PVC FITTINGS

NUT/SLEEVE FITTINGS



PRICE	PART #	SIZE
\$1.52	HF0330	3/8" H x 1/2" MIP
\$1.26	HF0335	1/2" H x 1/2" MIP

NUT & SLEEVE FITTINGS

NUT/SLEEVE FITTINGS



PRICE	PART #	SIZE
\$1.06	HF0314	1/4" O.D.
\$1.48	HF0315	3/8" O.D.
\$1.84	HF0319	1/2" O.D.

SLEEVE ONLY

NUT/SLEEVE FITTINGS



PRICE	PART #	SIZE
\$0.09	HF0316	For 1/4" Tube
\$0.23	HF0317	For 3/8" Tube
\$0.37	HF0318	For 1/2" Tube

UNION CONNECTORS

NUT/SLEEVE FITTINGS



PRICE	PART #	SIZE
\$5.64	HF0302	3/8"
\$5.15	HF0309	1/4"
\$6.27	HF0323	1/2"

HOSES & FITTINGS

HYDRAULIC ADAPTERS



JIC MALE CONNECTORS

HYDRAULIC ADAPTERS



PRICE	PART #	JIC THREAD	MALE PIPE
\$1.72	2404-6-6	9/16-18	3/8"
\$3.40	2404-6-8	9/16-18	1/2"
CALL	2404-8-4	1/2-16	1/4"
	2404-8-6	3/4-16	3/8"
	2404-8-8	3/4-16	1/2"
	2404-8-12	3/4-16	3/4"
	2404-12-8	1 1/16-12	1/2"
	2404-12-12	1 1/16-12	3/4"



JIC FEMALE CONNECTORS

HYDRAULIC ADAPTERS



PRICE	PART #	JIC THREAD	MALE PIPE
CALL	2405-6-6	9/16-18	3/8"
	2405-8-8	3/4-16	1/2"
	2405-12-8	1 1/16-12	1/2"
	2405-12-12	1 1/16-12	3/4"



JIC SWIVEL TO MALE PIPE ADAPTER

HYDRAULIC ADAPTERS



PRICE	PART #	JIC THREAD	MALE PIPE
CALL	6505-6-6	9/16-18	3/8"
	6505-8-6	3/4-16	3/8"
	6505-8-8	3/4-16	1/2"
	6505-12-12	1 1/16-12	3/4"



JIC SWIVEL TO FEMALE PIPE ADAPTER

HYDRAULIC ADAPTERS



PRICE	PART #	JIC THREAD	MALE PIPE
CALL	6506-6-6	9/16-18	3/8"
	6506-6-8	9/16-18	1/2"
	6506-8-6	3/4-16	3/8"
	6506-8-8	3/4-16	1/2"
	6506-12-12	1 1/16-12	3/4"

LOOKING TO REPLACE YOUR HOSE AND THREADED HOSE FITTINGS?

Get great deals on hoses and compression hose for your car wash or pressure wash business! Kleen-Rite offers standard, cut to size, cut to length, and bulk sizing on low to high pressure hoses along with durable hose fittings in all sizes.

NOT SURE WHAT SIZE FITTINGS YOU NEED?

Use the handy chart below before placing your order!

TUBING SIZE CHART

LAY TUBING FITTING ON CHART FOR SIZING

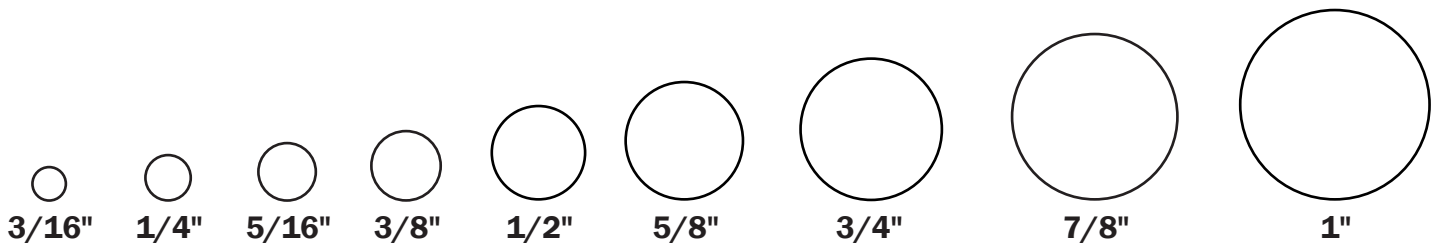

HOSES & FITTINGS

PARKER FITTINGS



REUSABLE SINGLE WIRE BRAID

PARKER REUSABLE HOSE FITTINGS

\$14.87	HF0145	1/4" M PIPE RIGID
\$28.04	HF0146	1/4" M PIPE SWIVEL
\$18.18	HF0147	1/2" M PIPE RIGID
\$14.47	HF0150	3/8" M PIPE RIGID
\$27.38	HF0151	3/8" M PIPE SWIVEL
\$17.15	HF0152	3/8" H X 1/4" M PIPE RIGID
\$18.55	HF0155	5/16" H X 1/4" M PIPE
\$33.37	HF0157	3/4" M PIPE RIGID
\$72.92	HF0158	1" M PIPE RIGID

REUSABLE DOUBLE WIRE BRAID

PARKER REUSABLE HOSE FITTINGS

\$72.92	HF0148	1/4" M PIPE RIGID 2-WB
\$14.36	HF0162	3/8" M PIPE RIGID 2-WB
\$25.00	HF0165	1/2" M PIPE RIGID 2-WB
\$25.59	HF0168	3/4" M PIPE RIGID 2-WB

REUSABLE 37° JIC

PARKER REUSABLE HOSE FITTINGS

\$36.69	HF0170	3/8" Male - Rigid End
\$25.28	HF0171	3/8" Female - Swivel End
\$40.10	HF0172	1/2" Female - Swivel End
\$36.41	HF0173	1/2" Male - Rigid End
\$67.27	HF0175	3/4" Female - Swivel End
\$24.04	HF0179	1/4" F 37° JIC SW 2-WB
\$28.36	HF0180	3/8" F 37° JIC SW 2-WB
\$34.07	HF0181	1/2" F 37° JIC SW 2-WB
\$35.36	HF0183	3/8" M SWIVEL DBL WB
\$35.36	HF0184	1/2" M SWIVEL DBL WB

REUSABLE ADAPTERS

PARKER REUSABLE HOSE FITTINGS

\$5.68	HF0177	FEMALE ADAPTER 3/8"
\$7.27	HF0178	FEMALE ADAPTER 1/2"

3/8" SINGLE WIRE BRAID HOSE REPAIR KIT

HOSE REPAIR KITS

- Kit includes: (2) 20142-6-6 Parker reusable hose fitting, (1) 140566 swivel 3/8" F x F, and (1) Teflon tape 1/2" x 520'

\$31.64	KRK2050
---------	---------

KLEEN-RITE CRIMP FITTINGS

KLEEN-RITE.com

MALE PIPE RIGID

KLEEN-RITE CRIMP FITTINGS

\$3.52	HU0404MB	1/4"
\$4.57	HU0406MB	1/4" WB x 3/8" MIP
\$4.66	HU0604MB	3/8" WB x 1/4" MIP
\$3.72	HU0606MB	3/8"
\$5.60	HU0608MB	3/8" WB x 1/2" MIP
\$5.55	HU0806MB	1/2" WB x 3/8" MIP
\$5.68	HU0808MB	1/2"
\$9.23	HU0812MB	1/2" WB x 3/4" MIP
\$15.78	HU1208MB	3/4" WB x 1/2" MIP
\$9.47	HU1212MB	3/4"
\$5.10	HU1612MB	1" WB x 3/4" MIP
\$14.19	HU1616MB	1"

KLEEN-RITE.com

FEMALE DEAD SWIVEL

KLEEN-RITE CRIMP FITTINGS

\$6.64	HU0606NC	3/8" x 3/8"
\$9.04	HU0808FPX	1/2"

KLEEN-RITE.com

FEMALE PIPE RIGID

KLEEN-RITE CRIMP FITTINGS

\$4.57	HU0404NB	1/4"
\$5.79	HU0606NB	3/8"
\$10.95	HU0608NB	3/8" WB x 1/2" F
\$7.27	HU0808NB	1/2"
\$15.80	HU1212NB	3/4"
\$30.88	HU1616NB	1"

PARKER DE SERIES PORTABLE CRIMPER

PARKER CRIMPERS

- Parker DE crimpers simplify the gauging aspects of crimping, and the new pusher retraction stop reduces cycle time, speeding up the task of making hydraulic hose assemblies. Strong yet lightweight top and bottom plates, improved one-piece handle and base design and a micrometer gauging mechanism are features that make this machine ideal for portable hose assembly. DE30's four strain rods reinforce precision and durability while color coded die sets make finding the right one a snap. This crimper is easily customized with a choice of optional pumps, dies and a die storage box.
- New micrometer gauging mechanism yields precise and infinitely variable crimp diameters
- Choice of pumps allows crimper to be run without electricity or on pneumatic power
- Compact, lightweight design makes transportation easy and convenient
- 30 tons of crimping force
- Dies are ordered separately, so choose only the dies you need
- One pusher plate serves all six die sets to reduce potential errors
- Four strain rods increase accuracy and durability

Parker



SPLIT RING STRAIGHT CRIMP DIES		
\$462.81	KRIMPDIE14	1/4" Die
\$500.19	KRIMPDIE38	3/8" Die
\$462.81	KRIMPDIE34	3/4" Die
\$495.01	KRIMPDIE12	1/2" Die
\$471.44	KRIMPDIE1	1" Die

\$3,052.67	KRIMPDE30	Crimp Machine
\$636.13	KRIMPPUMP	Hydraulic Hand Pump
\$1,490.79	KRIMPPUMPAIR	Air Pump

HOSES & FITTINGS



PARKER® TUBE AND HOSE FITTINGS



PARKER® GLOBALCORE 387
3000 PSI FLEXIBLE TOUGH COVER WIREBRAID HYDRAULIC HOSE
 PARKER



\$3.25	HOS387-4	1/4" Hose	\$8.19	HOS387-12	3/4" Hose
\$3.40	HOS387-6	3/8" Hose	\$11.02	HOS387-16	1" Hose
\$3.86	HOS387-8	1/2" Hose			

CRIMP STYLE SERIES 43 HYDRAULIC HOSE FITTINGS

PARKER TUBE FITTINGS



10343-8-8



10643-8-8

PRICE	PART #	SIZE
\$5.85	10343-6-6	3/8" M JIC 37° x 3/8" I.D.
\$7.11	10343-8-8	1/2" M JIC 37° x 1/2" I.D.
\$4.95	10143-4-6	1/4" M JIC x 1/8" I.D.
\$5.19	10143-6-4	3/8" Hose x 1/4" MPE

PRICE	PART #	SIZE
\$6.02	10643-6-6	3/8" F JIC 37° x 3/8" I.D.
\$7.72	10643-8-8	1/2" F JIC 37° x 1/2" I.D.
\$12.68	10643-12-12	3/4" F JIC 37° x 3/4" I.D.

CRIMP STYLE SERIES 37° 43 HYDRAULIC HOSE FITTINGS WITH DROPS

PARKER TUBE FITTINGS



SHORT DROP



LONG DROP

90° ELBOW - LONG DROP		
PRICE	PART #	SIZE
\$13.51	14143-6-6	F JIC 37° Swivel x 3/8" I.D.
\$21.73	14143-8-8	F JIC 37° Swivel x 1/2" I.D.
\$36.29	14143-12-12	F JIC 37° Swivel x 3/4" I.D.

90° ELBOW - SHORT & MEDIUM DROPS		
PRICE	PART #	SIZE
\$16.29	13943-8-8	F JIC 37° Swivel x 1/2" I.D. - short
\$19.66	11943-6-6	F JIC 37° Swivel x 3/8" I.D. - medium
\$21.48	11943-8-8	F JIC 37° Swivel x 1/2" I.D. - medium
\$38.06	11943-12-12	F JIC 37° Swivel x 3/4" I.D. - medium



STRAIGHT UNION



STRAIGHT UNION - LARGE HEX



STRAIGHT UNION
 THREAD CONNECTOR

TRIPLE-LOK® 37° FLARE TUBE - JIC STRAIGHT UNION

PARKER TUBE FITTINGS

STRAIGHT UNION		
PRICE	PART #	M JIC X M JIC
\$2.51	PLF500S	3/8" x 3/8"
\$3.74	PLF503S	1/2" x 1/2"
\$7.07	PLF505S	1/2" x 3/8"
\$8.00	PLF508S	3/4" x 3/4"

STRAIGHT LARGE HEX UNION		
PRICE	PART #	M JIC X M JIC
\$4.95	PLF500S-L	3/8" x 3/8"
\$6.66	PLF503S-L	1/2" x 1/2"
\$24.30	PLF508S-L	3/4" x 3/4"

STRAIGHT THREAD CONNECTOR		
PRICE	PART #	M JIC X M SAE
\$2.54	PLF530S	3/8" x 3/8"
\$3.68	PLF533S	1/2" x 1/2"
\$4.66	PLF535S	1/2" x 3/8"
\$5.34	PLF538S	3/8" x 9/8"

TRIPLE-LOK® 37° FLARE TUBE 90° ELBOW

PARKER TUBE FITTINGS



90° ELBOW



90° UNION ELBOW

90° ELBOW		
PRICE	PART #	M JIC X M SAE
\$9.03	PLF580S	3/8" x 9/16"
\$11.38	PLF582S	1/2" x 3/4"
\$19.26	PLF584S	3/4" x 11/16"

90° UNION ELBOW		
PRICE	PART #	M JIC X M JIC
\$5.94	PLF520S	3/8" x 3/8"
\$7.21	PLF522S	1/2" x 1/2"

90° LONG ELBOW		
PRICE	PART #	M JIC X M NPT
\$21.51	PLF680S-L	1/2" x 1/2"



TRIPLE-LOK® 37° FLARE TUBE JIC RUN TEE

PARKER TUBE FITTINGS

PRICE	PART #	M JIC X M NPT X M JIC RUN TEE
\$8.05	PLF570S	3/8" x 1/4" x 3/8"
\$14.37	PLF572S	1/2" x 3/8" x 1/2"
\$25.25	PLF574S	3/4" x 3/4" x 3/4"



TRIPLE-LOK® 37° FLARE TUBE STRAIGHT THREAD RUN UNION TEE

PARKER TUBE FITTINGS

PRICE	PART #	M JIC X M SAE X M JIC
\$16.25	PLF540S	1/2" x 3/4" x 1/2"



TRIPLE-LOK® 37° FLARE TUBE PIPE ADAPTER

PARKER TUBE FITTINGS

PRICE	PART #	SIZE
\$15.70	PLF550S	1 5/16" M SAE x 3/4" M NPT Pipe Adapter
\$6.65	PLF552S	3/4" M SAE x 1/2" M NPT Pipe Adapter

VISIT KLEENRITE.COM
FOR MORE PRODUCTS
FROM PARKER®



HOSES & FITTINGS

HYDRAULIC SWAGE FITTINGS



MALE RIGID JIC 37° HYDRAULIC SWAGE FITTINGS

- Zinc plated steel

PRICE	PART #	DESCRIPTION	HOSE I.D.	PIPE SIZE
\$9.73	SU0606MJ	Swage Fit 3/8" H x 3/8" M JIC	3/8"	3/8"
\$12.14	SU0808MJ	Swage Fit 1/2" H x 1/2" M JIC	1/2"	1/2"



MALE PIPE RIGID HYDRAULIC SWAGE FITTINGS

- Zinc plated steel

PRICE	PART #	DESCRIPTION	HOSE I.D.	PIPE SIZE
\$6.93	SU0404MB	Swage Fit 1/4" H x 1/4" M	1/4"	1/4"
\$8.13	SU0604MB	Swage Fit 3/8" H x 1/4" M	3/8"	1/4"
\$7.67	SU0606MB	Swage Fit 3/8" H x 3/8" M	3/8"	3/8"
\$14.00	SU0808MB	Swage Fit 1/2" H x 1/2" M	1/2"	1/2"
\$20.92	SU1212MB	Swage Fit 3/4" H x 3/4" M	3/4"	3/4"



30° INVERTED FLARE NPSM HYDRAULIC SWAGE FITTINGS

- Zinc plated steel

PRICE	PART #	DESCRIPTION	HOSE I.D.	PIPE SIZE
\$15.79	SU0606IF	Swage Fit 3/8" H x 3/8" NPSM	3/8"	3/8"
\$10.95	SU0808IF	Swage Fit 1/2" H x 1/2" NPSM	1/2"	1/2"



FEMALE SWIVEL JIC 37° HYDRAULIC SWAGE FITTINGS

- Zinc plated steel

PRICE	PART #	DESCRIPTION	HOSE I.D.	PIPE SIZE
\$9.86	SU0606NJ	Swage Fit 3/8" H x 3/8" F	3/8"	3/8"
\$12.63	SU0808NJ	Swage Fit 1/2" H x 1/2" F	1/2"	1/2"
\$27.94	SU1212NJ	Swage Fit 3/4" H x 3/4" F	3/4"	3/4"



MALE PIPE SWIVEL HYDRAULIC SWAGE FITTINGS

- Zinc plated steel

PRICE	PART #	DESCRIPTION	HOSE I.D.	PIPE SIZE
\$8.40	SU0404MC	Swage Fit 1/4" H x 1/4" M Swivel	1/4"	1/4"
\$21.20	SU0808MC	Swage Fit 1/2" H x 1/2" M Swivel	1/2"	1/2"
\$38.47	SU1212MC	Swage Fit 3/4" H x 3/4" M Swivel	3/4"	3/4"

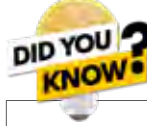

SYNFLEX® Hydraulic Swage Fittings meet or exceed hose specifications for all available terminal end configurations.

HOSE GUARDS & ACCESSORIES



TEFLON TAPE SWAGE FITTINGS SUPPLIES

- 1/2" x 520"
- Lubricates, allowing for a deeper seating of threads. Helps prevent threads from seizing when being unscrewed.
- Helps seal joints without hardening them, making them easier to tighten.

\$1.48 BFAT520



THREAD SEALANT SWAGE FITTINGS SUPPLIES

- 4 oz. jar with brush top
- All-purpose thread sealant that remains pliable after installation. Temperature range -65°F to 550°F. Withstands pressures up to 10,000 PSI.

\$6.51 DD49494



SPRING HOSE GUARDS HOSES

PRICE	PART #	SIZE
\$4.62	HU0400SG	1/4"
\$4.74	HU0600SG	3/8"



PVC HOSE GUARDS HOSES

PRICE	PART #	SIZE	COLOR
\$2.40	HF0800	3/8"	Black
\$2.14	HF0805	1/4"	Black
\$2.64	HF0810	1/2"	Black



HOSE GUARD FOR COILHOSE HOSES

PRICE	PART #	SIZE
\$2.87	CTG04	1/4"



BLACK MOTORCYCLE GRIP HOSE BEND PROTECTOR HOSES

- For 3/8" hose
- More UV/ozone resistant than rubber

\$4.03 SUT030871



NYLON SLEEVE HOSE GUARDS HOSES

PRICE	PART #	SIZE
\$1.35	NGB0106	3/8"
\$1.48	NGB0121	1/4"
\$1.79	NGB0128	1/2"

**GUARDS HOSES AGAINST
CORNERS AND ROUGH EDGES TO
EXTEND HOSE LIFE**



SPIRAL HOSE GUARDS HOSES

PRICE	PART #	COLOR
\$189.44	SGX25	.75" ID X 66'
\$271.25	SGX32	.94" ID X 66'
\$388.25	SGX50	1.50" ID X 66'

LARGER SIZES AVAILABLE

FEATURED PRODUCT



KLEEN-RITE HOSES & CUSTOM HOSE ASSEMBLIES

Kleen-Rite sells many different sizes of car wash high-pressure hose assemblies. Looking to reduce hose costs in your facility? In need of specific lengths and fittings? Don't sweat it, we've got you covered. Our hose department makes high-quality, custom hoses and fittings on a daily basis and will work with you to get you exactly what you need!

Hoses are essential for everyday car wash operations, and it's important to keep your facility well-stocked at all times. Kleen-Rite advises car wash operators to have one or two hose assemblies on hand for every bay, plus at least one foamy hose for every self-serve bay.

Thanks to custom hose assemblies, you can save costs and buy only the lengths you need. You can pick the right fittings compatible with your car wash equipment. Our professional, high-quality custom hoses are reliable and affordable.



CUSTOM HOSE ASSEMBLY CONSIDERATIONS:



LENGTH

From small 1 ft. assemblies to large lengths - just ask us!

PSI REQUIREMENT

DIAMETER

• 1/4" • 3/8" • 1/2" • 3/4" • 1"

COLOR

Black or Blue in 1/4" & 3/8"
Black available in other sizes!

WIRE BRAID

• Single or double wire braid

HOSE FITTINGS

- Male permanent or male swivel
- Female pipe
- Male & female 37° JIC
- Male & female 45° SAE



FEATURED PRODUCT

KLEEN-RITE'S CUSTOM HOSES

It's easy to order custom hose assemblies at Kleen-Rite. You can specify if you want a single or double wire braid hose designed for high pressure, low pressure, or foamy brush applications. Then, choose your desired hose color, length, diameter, and fittings. Once you've made your selections and the order comes in, our technicians will get to work!

Our staff will use machinery to precisely cut the hose to specified lengths. We've cut hoses of all sizes, from small 6 ft. assemblies to large 50 ft. hoses for truck washing applications. The hose ends enter our crimp machine, which secures your chosen fittings to the hose. We stock a large selection of permanent and swivel ends, as well as JIC and SAE fittings!

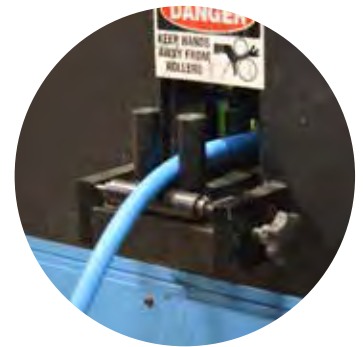

TIPS TO EXTEND THE LIFE OF YOUR HOSE ASSEMBLY



- ✓ • Make sure your hose has a higher working pressure than that of the pressure of the fluid being pumped through the hose. Putting a hose suited for 3000 PSI into a 5000 PSI application can cause over-pressurization that results in leaks and pulsation.
- ✗ • Avoid bending the hose too much, as this can cause kinks and premature hose failure.
- ✓ • Use elbow fittings. If a hose bends at a sharp angle without the added support of an elbow fitting it undergoes unnecessary stress leading to premature failure.
- ✗ • Don't stretch or compress the hose during installation.
- 💡 • Keep hoses off ground to avoid being run over by equipment or rubbing which will cause premature failure.

HOSES & FITTINGS

HOSES & TUBING



LLDPE POLY TUBING

KLEEN-RITE

KLEEN-RITE

- FDA approved Linear Low Density Polyethylene material
- Offers environmental stress-cracking resistance

COLOR	1/4" - 130 PSI		3/8" - 120 PSI		1/2" - 90 PSI	
	100'	500'	100'	500'	100'	500'
BLACK	PT100BK-100	PT100BK-500	PT300BK-100	PT300BK-500	PT800BK-100	PT800BK-500
BLUE	PT100BL-100	PT100BL-500	PT300BL-100	PT300BL-500	PT800BL-100	PT800BL-500
GREEN	PT100G-100	PT100G-500	PT300G-100	PT300G-500	PT800G-100	PT800G-500
NATURAL	PT100N-100	PT100N-500	PT300N-100	PT300N-500	PT800N-100	PT800N-500
RED	PT100R-100	PT100R-500	PT300R-100	PT300R-500	PT800R-100	PT800R-500
YELLOW	PT100Y-100	PT100Y-500	PT300Y-100	PT300Y-500	PT800Y-100	PT800Y-500
PRICE	\$26.44	\$91.61	\$30.15	\$111.05	\$35.97	\$145.92

25' COIL TUBING FOAMY HOSE WITH FITTINGS

HOSES

1/4" 25 FEET			3/8" 25 FEET			5/16" 25 FEET		
\$31.46	CT2504BWF	Blue	\$58.77	CT2506BWF	Blue	\$46.47	CT2505BWF	Blue
\$31.46	CT2504CWF	Clear/Blue Tint	\$58.77	CT2506CWF	Clear/Blue Tint	\$46.47	CT2505CWF	Clear/Blue Tint
\$31.46	CT2504GWF	Hot Green	\$58.77	CT2506GWF	Hot Green	\$46.47	CT2505YWF	Yellow
\$31.46	CT2504RWF	Red	\$58.77	CT2506RWF	Red			
\$31.46	CT2504YWF	Yellow	\$58.77	CT2506YWF	Yellow			

REPLACEMENT COIL TUBING FOAMY HOSE FITTINGS

POLYTUBE FITTINGS

\$6.98	CTF44S	1/4" CT x 1/4" M Swivel	\$9.05	CTF64S	3/8" CT x 1/4" M Swivel
\$8.57	CTF56S	5/16" CT x 3/8" M Swivel	\$9.05	CTF66S	3/8" CT x 3/8" M Swivel

TRIPLE FOAM COILED HOSE

FREELIN-WADE HOSES

- Bonded ribbon Fre-Thane 95A polyurethane tubing material provides a clean wash with no unwanted residue or incomplete sealing. Reliable triple foam washes for your customers on every application, facilitated with a durable coil hose!
- 33' working length - 3 transparent blue tint tubes bonded together
- Hose only, **FITTINGS NOT INCLUDED**

\$92.99 CT1000

NYLON POLY TUBING

POLYTUBING

- 375 PSI
- 250' Roll
- CALL FOR PRICING

PTN100BK	Black - 1/4" OD	PTN100N	Natural - 1/4" OD
PTN300BK	Black - 3/8" OD	PTN300N	Natural - 3/8" OD
PTN800BK	Black - 1/2" OD	PTN800N	Natural - 1/2" OD



EXCELON TUBING

THERMO PLASTICS

- Surgical grade silicon tubing, perfect for flexible foam brush hoses

\$1.19 /FT.	HCVE04	1/4" I.D. x 1/8" Wall
\$1.89 /FT.	HCVE08	1/2" I.D. x 1/8" Wall

BULK RUBBER HOSE REEL

PROPULSE



- Textured anti-abrasion cover for longer life
- Wire braid

REEL PRICE PER FT	PART #	SIZE	COLOR	PSI	DETAILS
\$1.70	HTC04	1/4"	Black	3262	Wrapped Rubber
\$1.78	HTC063BK	3/8"	Black	4000	Wrapped Rubber Finish
\$2.38	HTC064BL	3/8"	Blue		
\$1.95	HTC064G	3/8"	Gray	3000	Smooth Rubber Finish
\$1.54	HOS060	1/4"	Black		
\$1.54	HOS060BL	1/4"	Blue		

NOT FOR STEAM

HOSES & FITTINGS

HOSES & TUBING



BULK HOSE

POLY FLEX FOAMY BRUSH HOSE

- 50' OR MORE • 250 PSI

POLY FLEX			
\$0.55	HPF06Y	3/8"	Yellow
\$0.53	HPF06R	3/8"	Red
\$0.53	HPF06B	3/8"	Blue

POLY BRAID			
\$0.52	HPB04H	1/4"	Clear
\$0.73	HPB06H	3/8"	Clear
\$0.94	HPB08H	1/2"	Clear

SOLD IN 50' INCREMENTS ONLY!!!



FOAMY HOSE ASSEMBLY

POLY FLEX FOAMY BRUSH HOSE

- Available in red, blue, and yellow
- 3/8" x 15' long
- One end is equipped with a 3/8" push lock fitting (**PLF204**) and one end has a **HU00606MB** fixed male permanent end with a 3/8" MxF low pressure swivel (**SW0250**) attached
- Clear hose guard on one end for longer hose life

\$18.52	HA156FBL1443	Blue
\$18.83	HA156FY1443	Yellow
\$18.52	HA156FR1443	Red

14' COMFORT HOSE ASSEMBLY

MOSMATIC HOSES



- **FITTINGS:** 3/8" M
- **WORKING PRESSURE:** Up to 2900 PSI
- Inner material made from polyethersulfone (PES) instead of steel mesh
- Oil, UV, ozone-resistant and weatherproof
- Flexible in temperatures: -40°F to 140°F

CALL BOMP90088



The Kleen-Rite website has an expansive media section! Simply visit kleen-ritecorp.com and find resources in the footer at the bottom of every page to view articles, blogs, buyers guides, the Kleen-Scene, videos, and our large resource library!

Learn more about new car wash supplies, industry news, and car wash shows. Kleen-Rite offers informative articles, blog posts, buyer's guides, resources, and videos. We cover material for in-bay automatic, tunnel, self-serve, and pet washes. You'll hear from car wash owners and industry experts sharing their tips and tricks. In the Resource Library, you'll find safety data sheets and wiring diagrams you may need for your wash.



HOSES & FITTINGS

HYDRAULIC HOSES & ACCESSORIES



M3K HYDRAULIC HOSE

GATES HOSES



- High-pressure hydraulic oil lines. Exceeds ISO 18752 Grade B, SAE 100R17 and ISO 11237 R17 working pressure, minimum bend radius requirements, and performance requirements of EN 857 1SC. M3K hose has smaller exterior dimensions and significantly tighter bend radius than other SAE 100R1 and 100R2 hose.

REEL	FOOT	PART #	WIRE	COLOR	NOM. I.D.	NOM. O.D.	MAX. PSI
\$3.89	\$4.33	GHPC1157	1	Black	1/4"	.48	3250



SAE 100R7 HYDRAULIC HOSE

HYDRAULIC HOSE

- 1,000-3,000 PSI (67-207 bar) working pressure - meets SAE100R7 Specifications
- **CONSTRUCTION:** Black polyurethane cover, spiraled or braided synthetic fiber reinforcement with a nylon-lined core tube
- **APPLICATIONS:** General hydraulics, high-pressure gas transfer, chemical transfer
- **FEATURES:** Temperature range: -40°F to 212°F (-40°C to 100°C), Low Elongation

100'-125'	200'-250'	PART #	NOMINAL I.D.	MAX PSI
2.14	\$1.92	HOS3TR7-04	1/4"	2,800
2.67	\$2.39	HOS3TR7-06	3/8"	2,300
3.63	\$3.50	HOS3130-08K	1/2"	2,000
3.47	\$3.12	HOS3TR7-08	1/2"	2,050
8.54	\$7.95	HOS3130-12K	3/4"	1,250
8.32	\$7.47	HOS3TR7-12	3/4"	1,250
12.10	\$11.26	HOS3130-16K	1"	1,000
12.64	\$10.59	HOS3TR7-16	1"	1,000

ORANGE SAE 100R7 HYDRAULIC HOSE

HYDRAULIC HOSE

- 1,000-3,000 PSI (67-207 bar) working pressure - meets SAE100R7 Specifications
- **CONSTRUCTION:** Non-conductive marking and color code, orange polyurethane non-perforated cover, braided synthetic reinforcement, nylon-lined tube
- **APPLICATIONS:** General hydraulics, high-pressure gas transfer, chemical transfer
- **FEATURES:** Temperature range: -40°F to 212°F (-40°C to 100°C), Low Elongation, best value 100R7 hose

100'-125'	200'-250'	PART #	NOMINAL I.D.	MAX PSI
2.82	\$2.70	HOS3740-04K	1/4"	3,000
3.76	\$3.16	HOS3TR7N-04	1/4"	2,800
4.71	\$4.55	HOS3740-08K	1/2"	2,250
5.53	\$4.63	HOS3TR7N-08	1/2"	2,800



HF0132

REUSABLE HOSE FITTINGS

HYDRAULIC ACCESSORIES

- For 100R7 hose steel construction
- Configuration type: male NPTF pipe, rigid, straight

PRICE	PART #	SIZE
\$12.68	HF0132	1/4"



HYDRAULIC PUSHER

HYDRAULIC ACCESSORIES

PRICE	PART #	DESCRIPTION	SIZE
\$33.10	SUP005	Pusher, 3/8" MPE JIC Hydraulic	3/8"
\$104.59	SUP006	Pusher, 3/8" MP Swivel Hydraulic	3/8"
\$58.73	SUP009	Pusher, 1/2" MP Hydraulic	1/2"
\$155.58	SUP011	Pusher, 3/4" MP X JIC Hydraulic	3/4"
\$73.64	SUP012F	Pusher, 3/4" F, Hydraulic	3/4"
\$104.59	SUP015	Pusher, 3/8" F, Hydraulic	3/8"
\$73.64	SUP016	Pusher, 1/2" F, Hydraulic	1/2"



HYDRAULIC DIE

HYDRAULIC ACCESSORIES

PRICE	PART #	DESCRIPTION	SIZE
\$192.73	SUD304	Die, 1/4" Hydraulic	1/4"
\$192.73	SUD306	Die, 3/8" Hydraulic	3/8"
\$192.73	SUD308	Die, 1/2" Hydraulic	1/2"
\$87.16	SUD312	Die, 3/4" Hydraulic	3/4"

HOSES & FITTINGS

KLEEN-RITE CORP.

BULK HOSES AND TUBING

REINFORCED CLEAR HEAVY WALL POLYBRAID HOSE

KLEEN-RITE HOSES

SOLD IN 50' INCREMENTS ONLY

STANDARD COIL LENGTHS: • 3/16" to 1/2" - 300' • 5/8" to 1" - 200' • 1 1/4" - 2" - 100'



SOLD IN 50' INCREMENTS ONLY						
100 & OVER	UNDER 100	PART #	NOMINAL I.D.	NOMINAL O.D.	NOMINAL WALL	MAX. WORKING PSI AT 70° F
\$0.41	\$0.46	HPB03H	3/16"	3/8"	3/32"	250 PSI
\$0.46	\$0.52	HPB04H	1/4"	7/16"	3/52"	
\$0.54	\$0.63	HPB05H	5/16"	17/32"	7/64"	
\$0.66	\$0.73	HPB06H	3/8"	19/32"	7/64"	225 PSI
\$0.84	\$0.94	HPB08H	1/2"	3/4"	1/8"	200 PSI
\$1.15	\$1.31	HPB10H	5/8"	57/64"	1/8"	200 PSI
\$1.38	\$1.57	HPB12H	3/4"	1 1/32"	9/64"	150 PSI
\$2.11	\$2.40	HPB16H	1"	1 3/10"	15/32"	125 PSI
\$3.19	\$4.05	HPB20H	1 1/4"	1 5/8"	3/16"	100 PSI
\$4.43	\$4.43	HPB24H	1 1/2"	1 15/16"	7/32"	100 PSI
\$6.64	\$7.55	HPB32H	2"	2 1/2"	15/64"	75 PSI

SOLD BY 300' REEL ONLY					
PRICE	PART #	NOMINAL I.D.	NOMINAL O.D.	NOMINAL WALL	MAX. WORKING PSI AT 70° F
\$187.63	HPB04H-300	1/4"	7/16"	3/52"	250 PSI
\$263.14	HPB06H-300	3/8"	19/32"	7/64"	225 PSI
\$336.36	HPB08H-300	1/2"	3/4"	1/8"	200 PSI

REINFORCED CLEAR EXTRA HEAVY WALL POLYBRAID HOSE

KLEEN-RITE HOSES

SOLD IN 50' INCREMENTS ONLY

STANDARD COIL LENGTHS: • 1/8" to 1/2" - 300' • 5/8" to 1" - 200' • 1 1/4" - 2" - 100'



100 & OVER	UNDER 100	PART #	NOMINAL I.D.	NOMINAL O.D.	NOMINAL WALL	MAX. WORKING PSI AT 70°F
\$0.47	\$0.53	HPB02X	1/8"	21/64"	3/32"	350 PSI
\$0.59	\$0.69	HPB04X	1/4"	1/2"	1/8"	350 PSI
\$0.77	\$0.86	HPB05X	5/16"	9/16"	1/8"	275 PSI
\$0.85	\$0.97	HPB06X	3/8"	5/8"	1/8"	275 PSI
\$1.28	\$1.47	HPB08X	1/2"	13/16"	5/32"	250 PSI
\$2.06	\$2.35	HPB10X	5/8"	1"	3/16"	225 PSI

100 & OVER	UNDER 100	PART #	NOMINAL I.D.	NOMINAL O.D.	NOMINAL WALL	MAX. WORKING PSI AT 70°F
\$2.35	\$2.67	HPB12X	3/4"	1 1/8"	3/16"	200 PSI
\$2.93	\$3.34	HPB16X	1"	1 3/8"	3/16"	150 PSI
\$4.99	\$5.68	HPB20X	1 1/4"	1 3/4"	1/4"	125 PSI
\$5.74	\$6.52	HPB24X	1 1/2"	2"	1/4"	100 PSI
\$8.01	\$9.09	HPB32X	2"	2 1/2"	1/4"	75 PSI

NON-REINFORCED CLEAR VINYL FLEXIBLE TUBING

KLEEN-RITE HOSES

SOLD IN 50' INCREMENTS ONLY

• Non-reinforced clear vinyl, flexible tubing • STANDARD COIL LENGTHS: • 1 1/4" and up - 50' • All other sizes - 100'



100 & OVER	UNDER 100	PART #	NOMINAL I.D.	NOMINAL O.D.	NOMINAL WALL	MAX. WORKING PSI (70°F)
\$0.15	\$0.17	HCV02H	1/8"	1/4"	1/16"	60 PSI
\$0.11	\$0.15	HCV03T	3/16"	1/4"	1/32"	50 PSI
\$0.19	\$0.22	HCV03H	3/16"	5/16"	1/16"	55 PSI
\$0.34	\$0.38	HCV03X	3/16"	3/8"	3/32"	60 PSI
\$0.22	\$0.25	HCV04T	1/4"	3/8"	1/16"	55 PSI
\$135.00		HCV04T-500	500' Reel of HCV04T			
\$0.41	\$0.46	HCV04H	1/4"	7/16"	3/32"	58 PSI
\$0.53	\$0.61	HCV04X	1/4"	1/2"	1/8"	60 PSI
\$0.27	\$0.31	HCV05T	5/16"	7/16"	1/16"	50 PSI
\$0.43	\$0.49	HCV05H	5/16"	1/2"	3/32"	55 PSI
\$0.70	\$0.81	HCV05X	5/16"	9/16"	1/8"	60 PSI
\$0.31	\$0.35	HCV06T	3/8"	1/2"	1/16"	45 PSI
\$0.52	\$0.60	HCV06H	3/8"	9/16"	3/32"	50 PSI
\$0.74	\$0.86	HCV06X	3/8"	5/8"	1/8"	55 PSI
\$0.40	\$0.45	HCV08T	1/2"	5/8"	1/16"	30 PSI

100 & OVER	UNDER 100	PART #	NOMINAL I.D.	NOMINAL O.D.	NOMINAL WALL	MAX. WORKING PSI (70°F)
\$0.61	\$0.71	HCV08H	1/2"	1 1/16"	3/32"	40 PSI
\$0.78	\$0.81	H00004C	1/2"	3/4"	1/8"	45 PSI
\$0.75	\$0.86	HCV10H	5/8"	1 3/16"	3/32"	35 PSI
\$0.97	\$1.12	HCV10X**	5/8"	7/8"	1/8"	40 PSI
\$1.12	\$1.29	HCV12T	3/4"	1"	1/8"	35 PSI
\$1.80	\$2.09	HCV12H	3/4"	1 3/8"	3/16"	45 PSI
\$2.76	\$3.20	HCV12X	3/4"	1 3/4"	1/4"	40 PSI
\$1.45	\$1.67	HCV16T	1"	1 1/4"	1/8"	25 PSI
\$2.40	\$2.79	HCV16H	1"	1 3/8"	3/16"	30 PSI
\$1.77	\$2.06	HCV20T	1 1/4"	1 1/2"	1/8"	20 PSI
\$4.07	\$4.70	HCV20X	1 1/4"	1 3/4"	1/4"	40 PSI
\$3.24	\$3.75	HCV24H	1 1/2"	1 7/8"	3/16"	30 PSI
\$5.76	\$6.66	HCV32X	2"	2 1/2"	1/4"	35 PSI

** HCV10X SOLD IN 2' INCREMENTS

SOLD IN 50' INCREMENTS ONLY

REINFORCED CLEAR PVC POLY SPRING HOSE

KLEEN-RITE HOSES

• STANDARD COIL LENGTHS: • 1/4" to 1" - 100' • 1 1/4" to 3" - 50'

100 & OVER	UNDER 100	PART #	NOMINAL I.D.	NOMINAL O.D.	NOMINAL WALL	MAX. WORKING PRESS. AT 70°F
\$0.72	\$0.76	HPS04	1/4"	29/64"	3/32"	150 PSI
\$1.09	\$1.15	HPS06	3/8"	39/64"	1/8"	100 PSI
\$1.33	\$1.53	HPS08	1/2"	47/64"	1/8"	100 PSI
\$2.16	\$2.46	HPS12	3/4"	1 1/32"	9/64"	70 PSI
\$2.77	\$3.15	HPS16	1"	1 19/64"	5/32"	70 PSI
\$4.21	\$4.79	HPS20	1 1/4"	1 39/64"	3/16"	70 PSI
\$4.89	\$5.57	HPS24	1 1/2"	1 55/64"	3/16"	50 PSI

SOLD IN 50' INCREMENTS ONLY

REINFORCED CLEAR PVC X HEAVY POLY WIRE HOSE

KLEEN-RITE HOSES

• STANDARD COIL LENGTHS: • 1/4" to 1" - 100' • 1 1/4" to 3" - 50'

100 & OVER	UNDER 100	PART #	NOMINAL I.D.	NOMINAL O.D.	NOMINAL WALL	MAX. WORKING PRESS. AT 70°F
\$0.84	\$0.94	HPW04X	1/4"	1/2"	1/8"	250 PSI
\$1.13	\$1.29	HPW06X	3/8"	5/8"	1/8"	150 PSI
\$1.75	\$1.99	HPW08X	1/2"	13/16"	5/32"	150 PSI
\$2.82	\$3.20	HPW10X	5/8"	1"	3/16"	150 PSI
\$3.21	\$3.66	HPW12X	3/4"	1 1/8"	3/16"	150 PSI
\$4.02	\$4.58	HPW16X	1"	1 3/8"	3/16"	100 PSI

HOSES & FITTINGS



HOSE ASSEMBLIES



WIRE BRAID HOSE ASSEMBLY - SWIVEL SAVER & WHIP HOSES

CONTINENTAL HOSES

- All 1/4" hoses will have 1/4" male perm. ends
- All 3/8" hoses will have 3/8" male perm. ends
- Other ends are available at additional cost
- Specify Blue or Black hose

LENGTH	DESCRIPTION	LENGTH	DESCRIPTION
1'	1/4" or 3/8" Wire Braid Hose	7'	1/4" or 3/8" Wire Braid Hose
2'	1/4" or 3/8" Wire Braid Hose	8'	1/4" or 3/8" Wire Braid Hose
3'	1/4" or 3/8" Wire Braid Hose	9'	1/4" or 3/8" Wire Braid Hose
4'	1/4" or 3/8" Wire Braid Hose	10'	1/4" or 3/8" Wire Braid Hose
5'	1/4" or 3/8" Wire Braid Hose	11'	1/4" or 3/8" Wire Braid Hose
6'	1/4" or 3/8" Wire Braid Hose		



WIRE BRAID HOSE ASSEMBLY & FITTINGS

CONTINENTAL HOSES

- Single wire hose with male permanent ends, available in blue or black

1/4" WIRE BRAID ASSEMBLY

CONTINENTAL HOSES

12'	15'	18'
13'	16'	19'
14'	17'	20'

3/8" WIRE BRAID ASSEMBLY

CONTINENTAL HOSES

12'	15'	18'
13'	16'	19'
14'	17'	20'

FOR LENGTHS OVER 20'

CONTINENTAL HOSES

1/4" BLACK	3/8" BLACK
1/4" BLUE	3/8" BLUE

WE MAKE CUSTOM HOSE ASSEMBLIES



You can save money buying your hose from Kleen-Rite, our prices are lower than locally sourced hose outlets!

We offer stock and custom hose lengths. Our professional hose department produces high-quality, custom hoses and fittings on a daily basis and will work with you to get you exactly what you need! Call or visit our website for more information!



UBERFLEX™ DROP HOSES

PROPULSE



- **REINFORCEMENT:** Single Layer Textile Braid
- **HOSE SIZE:** 3/8" ID
- **IMPULSE LIFE:** 200,000+
- **BURST (MIN):** 3:1 Working Pressure
- **COVER:** Matte Textured Finish
- **TEMPERATURE (MAX):** 140°F
- **WORKING PRESSURE (MAX):** 4000 PSI

\$19.49	HUF126BK	12'		\$20.27	HUF126BL	12'	
\$21.80	HUF156BK	15'	BLACK	\$22.79	HUF156BL	15'	BLUE
\$24.39	HUF186BK	18'		\$25.57	HUF186BL	18'	

NOT FOR HOT WATER OR STEAM



CLEANSTREAM™ DROP HOSES

PROPULSE



- **REINFORCEMENT:** 1-Wire Braid
- **HOSE SIZE:** 3/8" ID
- **IMPULSE LIFE:** 200,000+
- **BURST (MIN):** 3:1 Working Pressure
- **COVER:** Matte Textured Finish
- **TEMPERATURE (MAX):** 140°F
- **WORKING PRESSURE (MAX):** 4000 PSI

\$27.46	HCS126BK	12'		\$28.55	HCS126BL	12'	
\$30.39	HCS156BK	15'		\$31.78	HCS156BL	15'	
\$33.34	HCS186BK	18'	BLACK	\$34.93	HCS186BL	18'	BLUE
\$43.32	HCS256BK	25'		\$45.85	HCS256BL	25'	
\$68.88	HCS506BK	50'		\$73.50	HCS506BL	50'	

NOT FOR HOT WATER OR STEAM

HOSES & FITTINGS

HIGH-PRESSURE HOSES



SINGLE WIRE BRAID - TEMPERATURE RATED AT -20°F TO 250°F

CONTINENTAL HIGH-PRESSURE HOSES

- Available in Black, Blue, Red, Gray & Yellow. With nitrile tube and oil-resistant cover. Ideal for bays and booms.

1/4"	\$1.78 PER FOOT	H00087	Black	3000 PSI	500 FT	86 lbs.
	\$1.49 PER FOOT	H00087BL	Blue	3000 PSI	500 FT	86 lbs.
3/8"	\$1.98 PER FOOT	H00088	Black	3000 PSI	300-500 FT	76-127 lbs.
	\$1.78 PER FOOT	H00088BL	Blue	3000 PSI	300-500 FT	76-127 lbs.
	\$2.32 PER FOOT	H00088R	Red	3000 PSI	500 FT	128 lbs.
	\$2.32 PER FOOT	H00088Y	Yellow	3000 PSI	500 FT	128 lbs.
1/2"	\$3.08 PER FOOT	H00091	Black	3000 PSI	500 FT	173 lbs.
	\$3.17 PER FOOT	H00091BL	Blue	2000 PSI	500 FT	173 lbs.
3/4"	\$6.35 PER FOOT	H00092	Black	1250 PSI	250 FT	119 lbs.
5/16"	\$2.72 PER FOOT	H00085	Black	3100 PSI	300-550 FT	104 lbs.
1"	\$10.14 PER FOOT	H00096	Black	1000 PSI	250 FT	186 lbs.

DOUBLE WIRE BRAID - TEMPERATURE RATED AT -20°F TO 250°F

CONTINENTAL HIGH-PRESSURE HOSES

- This double braid reinforced hose is great for higher working pressure applications, available with a black oil-resistant cover

1/4"	\$3.97 PER FOOT	H00086	Black	5000 PSI	250 FT	69 lbs.
3/8"	\$4.20 PER FOOT	H00089	Black	4000 PSI	250 FT	98 lbs.
1/2"	\$6.31 PER FOOT	H00090	Black	4000 PSI	250 FT	114 lbs.
3/4"	\$10.14 PER FOOT	H00094	Black	2250 PSI	250 FT	175 lbs.
1"	\$9.17 PER FOOT	H00098	Black	3000 PSI	250 FT	225 lbs.

RUBBER FIBER BRAID - TEMPERATURE RATED AT -10°F TO 158°F

CONTINENTAL HIGH-PRESSURE HOSES

- Lightweight textile reinforcement is perfect for applications up to 1200 PSI

1/4"	\$3.17 PER FOOT	H00081	Black	1200 PSI	500 FT	70 lbs.
3/8"	\$4.00 PER FOOT	H00082	Black	1200 PSI	500 FT	106 lbs.



XR16SC EXTENDED LIFE HYDRAULIC HOSE

CONTINENTAL HIGH-PRESSURE HOSES



- Don't worry about breaking or bursting a hose when choosing the Continental XR16SC Extended Life hose! It offers greater durability than a Standard Cover SR2SN hose thanks to its extra abrasion-resistant cover as well as its higher working and burst pressure. You can use this hose with the same B2 fitting series as your existing SR2SN hose - the switch is easy!
- 3000 PSI working pressure - 12000 PSI burst pressure
- XR extra abrasion resistant cover lasts up to 14 times longer than standard
- Use with B2 fittings
- Can directly replace standard hose version SR2SN (#20240259)
- 6" minimum bend radius - half of the SR2SN!
- Weight per foot: 0.83 lbs.
- Note: this hose is priced by the foot

\$9.09 PER FOOT **H00098**

FEATURES XR ABRASION RESISTANT COATING



SAVE MONEY! BUY A REEL!



HELPFUL HINT!



KLEEN-RITE MAKES AUTOMATIC HOSE ASSEMBLIES TO YOUR SPECIFICATIONS!!!

Available sizes include:
1/2", 3/4", and 1"

HOSES & FITTINGS

HOSES



SOLD IN 50' INCREMENTS ONLY
USE WITH PUSH-ON BARBS - NO CLAMPS

INSTA-GRIP™ LOW-PRESSURE FOAMY BRUSH HOSE

CONTINENTAL HOSES



- 500' Reel • 300 PSI working pressure in all sizes with 4:1 minimum safety factor
- For use with push-on fittings at working pressures of 300 PSI. For low-pressure hydraulic and pneumatic systems such as shop air systems, general industrial, and maintenance. Non-conductive, minimum electrical resistance, greater than 1 megohm per inch of hose length at 1000 volts DC. MSHA approved covers.
- Field repairable - No special tools needed
- Class "A" high oil resistant tube
- One braid of high strength synthetic yarn laid at the most effective angle for maximum strength & coupling holding ability

0-99'	100-499'	REEL	PRODUCT #	SIZE	COLOR
\$1.96/FT	1.82/FT	1.82/FT	GYI04BK	1/4"	Black
\$1.88/FT	1.74/FT	\$1.65/FT	GYI04BL	1/4"	Blue
\$1.64/FT	1.52/FT	\$1.44/FT	GYI04GR	1/4"	Green
\$1.64/FT	1.52/FT	\$1.44/FT	GYI04R	1/4"	Red
\$2.23/FT	2.08/FT	\$1.97/FT	GYI06BK	3/8"	Black
\$2.23/FT	2.08/FT	\$1.97/FT	GYI06BL	3/8"	Blue
\$2.23/FT	2.08/FT	\$1.97/FT	GYI06G	3/8"	Gray
\$2.25/FT	2.09/FT	\$1.98/FT	GYI06GR	3/8"	Green
\$2.23/FT	2.08/FT	\$1.97/FT	GYI06R	3/8"	Red
\$2.71/FT	2.52/FT	\$2.71/FT	GYI08BK	1/2"	Black
\$2.71/FT	2.52/FT	\$2.38/FT	GYI08BL	1/2"	Blue
\$2.71/FT	2.52/FT	\$2.38/FT	GYI08R	1/2"	Red
\$5.59/FT	5.18/FT	\$4.90/FT	GYI12BK	3/4"	Black
\$5.42/FT	5.03/FT	\$4.76/FT	GYI12BL	3/4"	Blue
\$5.42/FT	5.03/FT	\$4.77/FT	GYI12R	3/4"	Red



SOLD IN 50' INCREMENTS ONLY
EXCELLENT FOR AIR LINES OR FOAMY APPLICATIONS

PLIOVIC® HOSE

CONTINENTAL HOSES



- 750' Reel (up to 1/2") | 450' Reel 3/4" - 1" • 250 PSI working pressure. 4:1 safety factor
- A lightweight, economical general purpose hose for carrying air, water and many spray solutions, Pliovic® is suitable for a wide range of industrial, construction, agricultural hand sprayers and many multipurpose applications. Nonconductive, minimum electrical resistance greater than 1 megohm per inch of hose length at 1000 volts DC.
- Remains flexible at -10°F and withstands temperatures up to 150°F
- Class "B" medium oil resistance
- Reinforced with high strength Spiral Synthetic® fabric

0-99'	100-499'	REEL	PRODUCT #	SIZE	COLOR
\$0.67/FT	0.62/FT	\$0.59/FT	GYP04BK	1/4"	Black
\$0.68/FT	\$0.59/FT	\$0.59/FT	GYP04BL	1/4"	Blue
\$0.68/FT	0.62/FT	\$0.60/FT	GYP04R	1/4"	Red
\$0.51/FT	0.47/FT	\$0.45/FT	GYP04Y	1/4"	Yellow
\$0.82/FT	0.77/FT	\$0.73/FT	GYP06BK	3/8"	Black
\$0.82/FT	0.77/FT	\$0.73/FT	GYP06BL	3/8"	Blue
\$0.82/FT	0.77/FT	\$0.73/FT	GYP06R	3/8"	Red
\$0.53/FT	0.47/FT	\$0.45/FT	GYP06Y	3/8"	Yellow
\$1.05/FT	0.96/FT	\$0.92/FT	GYP08BK	1/2"	Black
\$1.05/FT	0.96/FT	\$0.92/FT	GYP08BL	1/2"	Blue
\$1.05/FT	0.96/FT	\$0.92/FT	GYP08R	1/2"	Red
\$0.85/FT	0.79/FT	\$0.75/FT	GYP08Y	1/2"	Yellow
\$1.62/FT	1.51/FT	\$1.42/FT	GYP12BL	3/4"	Blue
\$1.62/FT	1.51/FT	\$1.42/FT	GYP12R	3/4"	Red
\$2.25/FT	2.1/FT	\$1.98/FT	GYP16BL	1"	Blue
\$2.25/FT	2.1/FT	\$1.98/FT	GYP16R	1"	Red



SOLD IN 50' INCREMENTS ONLY

CLEAN MASTER® PRESSURE WASH

GATES HOSES



- 300' Reel
- Heavy duty for high pressure hot & cold cleaning - smooth cover
- High tensile reinforcement

REEL	FOOT	PART #	WIRE	COLOR	NOM. I.D.	NOM. O.D.	MAX. PSI
\$1.84	\$1.98	GHPC2225*	1	Black	3/8"	.68"	4000
\$1.30	\$1.40	GHPC2400*	1	Black	1/4"	.53"	4000
\$1.28	\$1.38	GHPC2402*	1	Black	3/8"	.68"	3000
\$1.95	\$2.08	GHPC2404*	1	Blue	3/8"	.68"	4000
\$2.58	\$2.75	GHPC2407*	2	Black	3/8"	.74"	5000
\$1.87	\$1.99	GHPC2408*	1	Black	1/2"	.80"	3500
\$1.79	\$1.90	GHPC2410*	2	Black	1/4"	.59"	6000
\$1.49	\$1.60	GHPC2419*	1	Blue	1/4"	.53"	4000
\$2.05	\$2.19	GHPC2426*	2	Black	1/2"	.86"	5000

* California Proposition 65



SOLD IN 50' INCREMENTS ONLY

PLANT MASTER PLUS

GATES HOSE



- 500' - 700' Reel • Oil resistant hose; excellent for hydraulic return lines

REEL	FOOT	PART #	COLOR	NOM. I.D.	NOM. O.D.	MAX. PSI
\$0.86	\$1.02	GHDF0002	Red	1/4"	.47"	250
\$1.12	\$1.26	GHDF0006	Red	3/8"	.66"	250
\$1.31	\$1.45	GHDF0008	Red	1/2"	.81"	250
\$2.18	\$2.46	GHDF0012	Red	3/4"	1.15"	250



SOLD IN 50' INCREMENTS ONLY

PLANT MASTER

GATES HOSES



- 500-700' Reel
- General purpose air & water hose. Great as a foam brush hose
- EPDM tube suitable for wide variety of chemicals

REEL	FOOT	PART #	COLOR	NOM. I.D.	NOM. O.D.	MAX. PSI
\$2.85	\$3.10	GHAF0016*	Red	1"	1.39"	200
\$0.88	\$1.02	GHAF1322*	Red	3/8"	.66"	250
\$1.14	\$1.27	GHAF1331*	Red	1/2"	.81"	250
\$0.78	\$0.96	GHAF1413*	Black	1/2"	.81"	250
\$2.47	\$2.81	GHAF1425*	Black	3/4"	1.5"	250

* California Proposition 65



SOLD IN 50' INCREMENTS ONLY

PLANT MASTER PLUS 300 LOCK-ON

GATES HOSES



- 500' - 700' Reel • For use with push-lock barb fittings. For water, chemical solutions, foam brush, anti-freeze solutions & more

REEL	FOOT	PART #	COLOR	NOM. I.D.	NOM. O.D.	MAX. PSI
\$1.03	\$1.19	GHPP0143	Blue	1/4"	.54"	300
\$1.19	\$1.33	GHPP0144	Blue	3/8"	.68"	300
\$1.48	\$1.72	GHPP0145	Blue	1/2"	.81"	300
\$1.27	\$1.45	GHPP0184	Black	3/8"	.68"	300
\$1.22	\$1.39	GHPP0334	Red	3/8"	.68"	300

CLAMP ASSEMBLIES



A NEW BREAKTHROUGH
IN CUSHIONED CLAMPING

CUSH-A-NATOR® CLAMPS

- Thumb Drive - The Cush-A-Nator® has the exclusive "Thumb Drive" that provides the installer a gripping point to easily open the cushion with the help of leverage tabs and a living hinge. Easy and effortless to install.
- Self-Alignment - Cushion can be opened and placed over the pipe or tube and rotated into place while on the channel and automatically aligned with the channel opening ready for clamping. No more pre-installing cushions or awkward installation. Cushion replacement has been made simple and easy.
- Pressure Control - The Cush-A-Nator® cushion has a built in squeeze control as part of the cushion design. The side opening and the squeeze control tab provide evenly distributed pressure around the tube or pipe.
- Complete Clamping Unit - The Cush-A-Nator® is the only strut mounted cushion that is mechanically connected to the supporting steel clamp because the bolt passes through the squeeze control tab forming the single unit connection. This design helps prevent the cushion from excess vibration by being attached directly to the clamp.

STEEL CLAMPS



PRICE	PART #	TUBE O.D.	PRICE	PART #	TUBE O.D.
\$4.00	CN04	1/4"	\$4.45	CN12	3/4"
\$4.00	CN06	3/8"	\$5.36	CN14	7/8"
\$4.00	CN08	1/2"	\$5.73	CN16	1"
\$4.18	CN10	5/8"	\$6.27	CN18	1 1/8"

STAINLESS STEEL CLAMPS



PRICE	PART #	TUBE O.D.	PRICE	PART #	TUBE O.D.
\$3.24	CN04SS	1/4"	\$22.04	CN14SS	7/8"
\$14.85	CN06SS	3/8"	\$23.74	CN16SS	1"
\$14.85	CN08SS	1/2"	\$26.43	CN18SS	1 1/8"
\$15.70	CN10SS	5/8"	\$28.70	CN20SS	1 1/4"
\$20.07	CN12SS	3/4"			

CUSH-A-CLAMP® CLAMPS

- Cush-A-Clamp channel mounted clamping systems are ideal for multiple line runs, while absorbing shock and vibration, reducing unwanted noise and preventing galvanic corrosion.

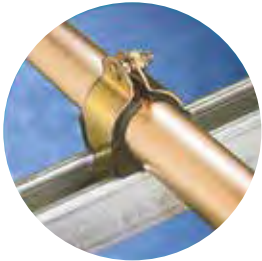

CLAMP & CUSHION ASSEMBLIES FOR HOSE & PIPE (NOT COPPER) CLAMPS

PRICE EA.	PART #	ID	OD	MATERIAL	PRICE EA.	PART #	ID	OD	MATERIAL
\$4.15	CL09N012	1/4"	.54"	Zinc	\$13.94	CL09NS012	1/4"	.54"	Stainless Steel
\$4.34	CL11N014	3/8"	.67"		\$14.73	CLS11NS014	3/8"	.67"	
\$5.57	CL14N018	7/8"	.84"		\$20.69	CLS14NS018	1/2"	.84"	
\$6.42	CL17N022	3/4"	1.05"		\$24.82	CLS17NS022	3/4"	1.05"	



CLAMP & CUSHION ASSEMBLIES FOR TUBING TYPES OR COPPER WATER PIPE CLAMPS

PRICE EA.	PART #	TUBING OD	COPPER NOM.	MATERIAL	PRICE EA.	PART #	TUBING OD	COPPER NOM.	MATERIAL
\$4.15	CL04T008	1/4"	-	Zinc	\$13.94	CLS06NS010	3/8"	1/4"	Stainless Steel
\$4.15	CL06T010	3/8"	1/4"		\$13.94	CLS08NS012	1/2"	3/8"	
\$4.15	CL08T012	1/2"	3/8"		\$14.73	CLS10NS014	5/8"	1/2"	
\$4.34	CL10T014	5/8"	1/2"		\$18.84	CLS12NS016	3/4"	5/8"	
\$4.62	CL12T016	3/4"	5/8"		\$20.69	CLS14NS018	7/8"	1/2"	
\$6.02	CL14T018	7/8"	-		\$22.29	CLS16NS020	1"	-	
\$5.94	CL16T020	1"	-		\$24.82	CLS18NS022	1 1/8"	-	
\$6.51	CL18T022	1 1/8"	-		\$24.82	CLS20NS024	1 1/4"	-	



CUSH-A-CLIP® CLAMPS

- A simple, economical, lightweight hanger for supporting tubing. Manufactured from black nylon.
- One-piece design makes installation a snap!
- Temperatures from -40°F to 275°F.
- Secure but non-tightening design allows for expansion, greatly reducing joint fractures.

PRICE	PART #	SIZE	PRICE	PART #	SIZE
\$3.68	CLRPC6	3/8"	\$3.96	CLRPC12	3/4"
\$3.68	CLRPC8	1/2"	\$4.43	CLRPC14	7/8"
\$3.68	CLRPC10	5/8"	\$5.38	CLRPC18	1 1/8"



ANOTHER NEW
CLAMPING CONCEPT



ALPHA SERIES® CLAMPS

- Designed for the tough jobs - secures pipe runs to any flat surface. Cushion design provides total load distribution, allowing the U-bolt to become a full contact hanger, eliminating knife edge loading.
- The U-bolt traps & secures the cushion in place to prevent lateral movement, while nylon insert locknuts provide a positive lock.

GALVANIZED		
PRICE	PART #	SIZE
\$15.94	CLUB16PA	1"
\$8.80	CLUB24PA	1 1/2"
\$8.80	CLUB32PA	2"



STAINLESS STEEL		
PRICE	PART #	SIZE
\$31.57	CLUBS12PA6	3/4"
\$17.76	CLUBS16PA6	1"
\$43.24	CLUBS20PA6	1 1/4"



HOSES & FITTINGS

CLAMP ASSEMBLIES



OMEGA SERIES® CLAMPS

- Omega Series clamp assembly retains, guides, protects and uniformly spaces line runs. Attached with 2 standard fasteners to any flat surface, eliminates the use of special channels. Lines are rigid and look neat.
- **THE CLAMP:** Available in steel (with electrochromate finish), and stainless steel.
- **THE CUSHION:** Manufactured from a thermoplastic elastomer, it's built tough to withstand the effects of most oils, chemicals and industrial cleaning compounds, in temperatures from -50°F to 275°F. Interlock edge ensures the cushion remains in place.

PRICE EA.	PART #	TUBING OD	COPPER NOM.	MATERIAL	PRICE EA.	PART #	TUBING OD	COPPER NOM.	MATERIAL
\$3.40	CL08M011	1/2"	1/4"	Steel	\$8.10	CLS06MS008	3/8"	-	Stainless Steel
\$3.49	CL10M013	5/8"	3/8"		\$8.10	CLS08MS011	1/2"	1/4"	
\$4.06	CL12M015	3/4"	-		\$9.29	CLS12MS015	3/4"	-	
\$4.53	CL16M019	1"	-		\$9.96	CLS14MS017	7/8"	1/2"	
\$5.09	CL18M020	-	3/4"		\$10.76	CLS16MS019	1"	-	
					\$12.20	CLS18MS020	-	3/4"	

California PROPOSITION 65

CUSH-A-CLAW® CLAMPS

- Cush-A-Claw grabs tube, pipe, or hose and holds it firmly. One-piece patented design for quick and easy installation. Will not rust because it's molded from the same TPE Material as other ZSI products that you've come to know and trust.
- Quick, simple, and easy snap-in installation of tube, pipe, or hose
- Sure Grip Strut Base easily rotates into strut
 - Non-conducting
 - Saves time and money
 - Works great indoors or outdoors
- Will not rust
- Temp range: -50° to 275°F
- Six sizes of tube and three sizes of EMT
- Designed for light duty loads and applications
- Prevents galvanic corrosion of dissimilar metals
- An excellent alternative to steel, stainless steel, or galvanized clamps

California PROPOSITION 65



STRUT MOUNTED CUSH-A-CLAW CLAMPS



\$1.24	CL04	1/4" Cush-a-Claw
\$1.24	CL06	3/8" Cush-a-Claw
\$1.24	CL08	1/2" Cush-a-Claw
\$1.24	CL10	5/8" Cush-a-Claw
\$1.24	CL12	3/4" Cush-a-Claw
\$1.31	CL14	7/8" Cush-a-Claw
\$1.31	CL18	1 1/8" Cush-a-Claw
\$1.10	CLEMT08	1/2" EMT Conduit Cush-a-Claw
\$0.48	CLEMT12	3/4" EMT Conduit Cush-a-Claw
\$1.31	CLEMT16	1" EMT Conduit Cush-a-Claw

California PROPOSITION 65

SURFACE MOUNTED CUSH-A-CLAW CLAMPS



\$1.24	CLS04	1/4" Cush-a-Claw
\$1.31	CLS06	3/8" Cush-a-Claw
\$1.31	CLS08	1/2" Cush-a-Claw
\$1.31	CLS10	5/8" Cush-a-Claw
\$1.31	CLS12	3/4" Cush-a-Claw
\$1.31	CLS14	7/8" Cush-a-Claw
\$1.38	CLS18	1 1/8" Cush-a-Claw
\$1.17	CLEMTS08	1/2" EMT Conduit Cush-a-Claw
\$1.17	CLEMTS12	3/4" EMT Conduit Cush-a-Claw
\$1.31	CLEMTS16	1" EMT Conduit Cush-a-Claw

California PROPOSITION 65

HOSE CLAMPS HOSES & FITTINGS



PRICE	PART #	SIZE
\$1.10	CL0100	7/32" - 5/8"
\$2.10	CL0130	7/8" - 1 3/4"
\$1.95	CL0105	7/16" - 1 1/16"
\$1.10	CL0110	7/16" - 7/8"
\$1.93	CL0112	Wideband 3/8" - 7/8" SS
\$1.55	CL0115	1/2" - 1 1/16"
\$1.55	CL0120	9/16" - 1 1/4"
\$2.20	CL0112-8	7/16" - 1"
\$0.98	CL0112-10	9/16" - 1 1/16"
\$2.65	CL0112-12	9/16" - 1 1/4"

California PROPOSITION 65

PRICE	PART #	SIZE
\$2.22	CL0112-16	11/16" - 1 1/2"
\$2.24	CL0112-20	3/4" - 1 3/4"
\$2.35	CL0125	1 1/16" - 1 1/2"
\$1.99	CL0112-24	1 1/16" - 2"
\$2.00	CL0112-28	1 5/16" - 2 1/4"
\$2.15	CL0112-32	1 9/16" - 2 1/2"
\$2.23	CL0112-36	1 13/16" x 2 3/4"
\$2.76	CL0112-48	2 9/16" x 3 1/2"
\$3.21	CL0112-72	3" x 5"

NEW!

KLEEN-TRACK CERAMIC SEALANT

**Ceramic car wash
sealant at a price
you'll love!**



Kleen-Rite is proud to offer a new ceramic product that allows more owners to offer this popular option at their car wash! Ceramic is all the rage with car lovers and has quickly caught the attention of many car wash operators. With that in mind, Ceramic Sealant has been added to the Kleen-Track line, a group of products that utilize a 2-step low and high pH presoak approach. Kleen-Track Ceramic Sealant is the perfect complement to the presoaks, as it's ideal for friction washes where pH is neutralized.

The ceramic polymer formula is highly hydrophobic, providing excellent water break and beading.

And it's more affordable than comparable brand name products!

KRKTC5	5 Gal.
KRKTC30	30 Gal.
KRKTC55	55 Gal.

KLEEN-RITE CORP.
YOUR RELIABLE SUPPLIER FOR THE CAR WASH INDUSTRY

FEATURED PRODUCT



KLEEN-RITE CONCENTRATED CHEMICALS

Kleen-Rite concentrated chemicals are a cost-effective way to get great results at your self-serve, tunnel, or automatic car wash! Our selection of highly concentrated formulas includes:

- Foam Detergent
- Foam Polish
- Presoak
- Beading Sealant
- Shine Sealant
- High Pressure Soap
- Wheel & Tire Cleaner

WHAT ARE CONCENTRATES?

Kleen-Rite concentrated formulas are full of active ingredients - in fact, that's all they are!

Traditionally, car wash chemicals sold in large drums are pre-mixed with water. That means you're paying for something you already pay for at your business: H₂O. Concentrates leave the water out, giving you just the chemical formula.

Concentrates come in compact 5-gallon containers that are easy to ship, lift, and move. This size is perfect for the solo car wash operator, or anyone tired of figuring out where to put large drums! Kleen-Rite concentrates can be easily stored until use, then blended with water. Combining a single 5-gallon Kleen-Rite ultra concentrated formula with 10 gallons of water produces 15 gallons of ready to use formula!

CONCENTRATED BENEFITS

- More product per dollar
- Allows complete control over dilution levels
- Ships in a space-saving 5 gallon container
- No freight lift gate required on small orders!
- For use at all types of car washes
- Wide variety of formulas and scents available

KLEEN-PAK SOLUTIONS

Want the benefits of a concentrate but not interested in any 55-gallon drums - not even for mixing? Check out the incredibly space-saving Kleen-Pak system!

Every component of the Kleen-Pak system is rectangular, meaning it's easy to line up, stack, and store. Each Kleen-Pak formula comes in a set of two 2.5-gallon containers - even easier to lift than our regular concentrates! These convenient containers fit directly on top of Kleen-Rite's compact Easy-Kleen dispensing station. One Easy-Kleen station holds up to 12.5 gallons of concentrate, which makes more diluted product than you'd find in a standard 55-gallon drum! More product, more free space, and less money out of your pocket!



FEATURED PRODUCT

KLEEN-RITE SELF SERVE ULTRA CONCENTRATES

KLEEN-RITE CORP.



ORANGE CREME HIGH PRESSURE SOAP



- White Foam
- Citrus Scent
- Yellow Tip
- 600-900/1
- **ADD 10 GALLONS OF WATER**

CALL KRC261



PURPLE PASSION PRESOAK DETERGENT



- Purple Foam
- Grape Scent
- Yellow Tip
- 200-300/1
- **ADD 10 GALLONS OF WATER**

CALL KRC253



VANILLA CREME HIGH PRESSURE SOAP



- White Foam
- Vanilla Scent
- Yellow Tip
- 600-900/1
- **ADD 10 GALLONS OF WATER**

CALL KRC262



SUMMER BREEZE PRESOAK DETERGENT



- Teal Foam
- Summer Rain Scent
- Yellow Tip
- 200-300/1
- **ADD 10 GALLONS OF WATER**

CALL KRC255



SONIC WASH HIGH PRESSURE SOAP



- White Foam
- Summer Scent
- Yellow Tip
- 600-900/1
- **ADD 10 GALLONS OF WATER**

CALL KRC260



DEEP BLUE SEALANT



- Blue Foam
- Piña Colada Scented
- Pink or Purple Tip
- 600-900/1
- **ADD 10 GALLONS OF WATER**

CALL KRC280



BUBBLE-UP FOAM BRUSH DETERGENT



- Blue Foam
- Bubble Gum Scent
- Yellow Tip
- 600-900/1
- **ADD 10 GALLONS OF WATER**

CALL KRC272



JUST PEACHY SEALANT



- Peach Scent
- Pink or Purple Tip
- 600-900/1
- **ADD 10 GALLONS OF WATER**

CALL KRC279



CHERRY BLOSSOM FOAM BRUSH DETERGENT



- Pink Foam
- Cherry Scent
- Yellow Tip
- 600-900/1
- **ADD 10 GALLONS OF WATER**

CALL KRC271



KLEEN WHITE TIRE CLEANER



- Green Foam
- Spearmint Scent
- Blue or Tan Tip
- 60-90/1
- **ADD 10 GALLONS OF WATER**

CALL KRC251

Featured Products



KLEEN-RITE AUTOMATIC - DETERGENTS, WHEEL CLEANERS & POLISHES



IN-BAY PRESOAK KLEEN-RITE DETERGENTS



- High quality, liquid alkaline presoak detergent at low distributor pricing. It breaks down stubborn road film and is the best presoak to choose for friction conveyor washes. It's also considered the second step to follow up a low pH first step in a touch-free wash process.

FEATURES:

- Liquid alkaline detergent
- Contains unique water conditioners for optimal performance
- Removes road film/soils, & windshield residue
- High strength and high sudsing

DILUTION:

- 75-120/1 • Touchless: 50-75/1
- Friction: 120/1

KR5019	5 Gallons
KR30019	30 Gallons
KR55019	55 Gallons



WHEEL BRITE WHEEL CLEANERS AND POLISHES



- A spray on, rinse off wheel cleaner. Attacks brake dust & road grime. Leaves wheels sparkling bright.
- Economical replacement for Quicksilver
- **DILUTION:** 8-17/1

KR5113	5 Gallons
KR30113	30 Gallons
KR55113	55 Gallons



ALL SYSTEMS POLYMER LOW PH PRESOAK KLEEN-RITE DETERGENTS



- Versatile presoak can be used in self-serve, tunnel, and in-bay automatics! Take advantage of the low pH level as the first step and true low pH/high pH combination, or as an answer to road salt blooms. Low pH presoak also helps prevent paint browning in hot summer months
- **LOW PRESSURE DILUTION:** 50-75:1
- **HIGH PRESSURE DILUTION:** 150-160:1

KR5205-L	5 Gallons
KR30205-L	30 Gallons
KR55205-L	55 Gallons



ALL SYSTEMS POLYMER HIGH PH PRESOAK KLEEN-RITE DETERGENTS



- Versatile presoak can be used in self-serve, tunnel, and in-bay automatics! Take advantage of the high pH level for superior overall cleaning for the car wash looking for a single product solution.
- **LOW PRESSURE DILUTION:** 50-75:1
- **HIGH PRESSURE DILUTION:** 150-160:1

KR5205	5 Gallons
KR30205	30 Gallons
KR55205	55 Gallons



KLEEN SEAL WITH POLYMERS WHEEL CLEANERS AND POLISHES

- Provides the lasting protection of reactive polymers. Water beads up and rolls right off automobile surfaces. Fresh piña colada scent.
- **DILUTION:** 120-240/1

KR5300	5 Gallons
KR30300	30 Gallons
KR55300	55 Gallons

KLEEN-RITE AUTOMATIC - DETERGENTS, WHEEL CLEANERS & POLISHES



SUPER KLEEN BAY WASH

KLEEN-RITE DETERGENTS

- Fully formulated all-purpose high-pressure bay wash
- **DILUTION:** 5-120/1

KRSK70	5 Gallons
---------------	-----------



IN-BAY DRYING AGENT

KLEEN-RITE DETERGENTS

- Gives in-bay operators maximum drying action plus gloss enhancers on vehicles to help blowers on in-bay automatics. Carnauba based with lemon scent
- **DILUTION:** 75-120/1

KR5325	5 Gallons
KR30325	30 Gallons
KR55325	55 Gallons



SUPER KLEEN WHEEL CLEANER

WHEEL CLEANERS AND POLISHES

- Golden yellow liquid surfactant blend
- Spearmint fragrance
- **DILUTION:** 100/1

KRSK60	5 Gallons
---------------	-----------



RED HOT TIRE

WHEEL CLEANERS AND POLISHES

- Multi-purpose tire and engine cleaner
- Pink foam
- **DILUTION:** 8-24/1

KR5400	5 Gallons
KR30400	30 Gallons
KR55400	55 Gallons



SUPER KLEEN PRESOAK

KLEEN-RITE DETERGENTS

- Fully formulated presoak with Bubble Gum scent
- **DILUTION:** 75-120/1

KRSK20	5 Gallons
---------------	-----------

TO BE USED WITH SUPER KLEEN POWDER



SUPER KLEEN POWDER

POWDERS

- Fully formulated, highly soluble alkaline powder
- 50 lbs
- **DILUTION:** 20-60/1

KRSK10	HAZARDOUS MATERIAL
---------------	--------------------



WINTER TRIPLE FOAM

WHEEL CLEANERS AND POLISHES

- This high foaming winter formula allows you to sell your customers the extra services they are accustomed to buying, even in the coldest temperatures.
- **DILUTION:** 4-15/1

KRATF5B	5 Gallons blue
KRATF5P	5 Gallons pink
KRATF5Y	5 Gallons yellow



NON-CORROSIVE WHEEL CLEANER

WHEEL CLEANERS AND POLISHES

- May be suitable for use in areas with chemical regulations; check local restrictions
- Safe, biodegradable, and affordable
- Noncorrosive salt solution formula
- Tested against acids and alkaline in automated tunnels (ratios between 17:1 - 65:1)
- Safe for use in hot or cold environments
- Eliminates wintertime road salt and magnesium deposits
- **DILUTION:** Ratios between 17:1 - 65:1

KR55402	55 Gallons
----------------	------------

FEATURED PRODUCT

KLEEN-TRACK CHEMICALS FOR IN-BAY AUTOMATICS



THIS PRESOAK SYSTEM PACKS A POWERFUL 1-2 PUNCH!

The Kleen-Track System is formulated for both touchless and friction automatic car washes. This two-step process is used in the early stages of an automatic wash and employs a strategic application of low pH presoak followed by a high pH presoak. Kleen-Track is available in three options: System 1, System 2, and Non-Corrosive System 3. All are available in 5-gallon, 30-gallon, and 55-gallon sizes.

SYSTEM 1

Kleen-Track 1A is the strong low pH option in the Kleen-Track line, and the first step of System 1. The acidic 1A liquid presoak contains powerful ammonium fluoride. Dilute to 75-120/1. Also available in an extra-strength concentrated form.

Kleen-Track 1B is the high pH second step of System 1. This alkaline formula is applied after 1A. Dilute to 64-90/1. If you choose to only use a single presoak, we recommend this product from the Kleen-Track line.

SYSTEM 2

Kleen-Track 2A is the low pH first step of System 2 and contains phosphoric acid. Dilute to 75-120/1. System 2 tolerates slightly hard water conditions. Also recommended for operators desiring a less aggressive presoak.

Kleen-Track 2B is the second step of System 2 and is formulated with high pH alkalines. This formula is applied after 2A. Dilute to 64-90/1.

SYSTEM 3 NON-CORROSIVE

Kleen-Track 3A is the low pH first step of System 3. It blends surfactants, solvents, and citric acid together in a non-corrosive formula. Dilute to 75-120/1.

Kleen-Track 3B is the high pH step in System 3. This formula contains both surfactants and alkalines. Applied after 3A has already been used. Dilute to 64-90/1.

WHY USE BOTH A LOW PH AND HIGH PH PRESOAK?

When a two-step presoak method is used properly, a low pH acidic formula is used before the high pH alkaline formula. Low pH presoaks can tackle materials like oxidation, salts, light oil, tiny metal particles, and small dirt fragments. It also cools the vehicle surface and reduces the chance of chemically flashing the paint.

High pH presoaks attack oils, larger dirt particulates, proteins, and heavy grease. You'll find that the high pH presoak does the bulk of the cleaning work. Most heavy-duty cleaners, in general, are alkaline.



KLEEN-TRACK 1A PRESOAK

- Low pH - strong and effective formula
- Contains ammonium fluoride
- 55-gallon size - Dilute 75-120/1
- KR# **KRKT1A55**



KLEEN-TRACK 1B PRESOAK

- High pH
- Alkaline blend
- 55-gallon size - Dilute 64-90/1
- KR# **KRKT1B55**



HELPFUL TIP

- You may need to try each system to find what works best with your equipment, the climate you live in, or the contaminants that commonly end up on vehicles in your area. Consider first buying 5-gallon sizes of each Kleen-Track system to test and determine the optimal system for you. After that, you can buy the larger bulk sizes to save money!

FEATURED PRODUCT

KLEEN-RITE AUTOMATIC - TOUCHLESS®



INCLUDED IN FREE SHIPPING SPECIAL!

REVOLUTIONARY 2 STEP CLEANING PROCESS

KLEEN-TRACK SYSTEM ONE

KLEEN-RITE TOUCHLESS CHEMICALS



PRODUCT	PART #	GALLONS	DESCRIPTION	DILUTION	COLOR	SCENT
Kleen-Track 1A Low pH	KRKT1A5*	5	Strong and effective low pH liquid presoak in the Kleen-Track line. This product is formulated for use as a first step in a two-step Touchless Wash Process. Product contains Ammonium Bifluoride	75-120:1	Light Golden	Fruit/Gum
	KRKT1A30*	30				
	KRKT1A55*	55				
Kleen-Track 1A-EXP Low pH	KRKT1A5-EXP*	5	Specially Formulated Extra Strength low pH presoak for enhanced touch free cleaning. This product is used as the first step application of a two-step cleaning process. Pleasantly scented, contains Ammonium Bifluoride.	75-120:1	Light Pink	Lemon Clean
	KRKT1A30-EXP*	30				
	KRKT1A55-EXP*	55				
Kleen-Track 1B High pH	KRKT1B5*	5	A high pH liquid presoak formulated for use as a second step in a two-step Touchless Wash Process. Its application is best when preceded by an acidic pre soak.	64-90:1	Red Transparent	-
	KRKT1B30*	30				
	KRKT1B55*	55				
Kleen-Track 1B-EXP High pH	KRKT1B5-EXP*	5	Formulated for use as a second step in a two-step touchless wash process, works best when preceded by an acidic presoak. Additional sequestering agents improve cleaning properties, particularly in regions with hard water and against soils that require an alkaline/high pH compound.	64-90:1	Light Pink	-
	KRKT1B30-EXP*	30				
	KRKT1B55-EXP*	55				

KLEEN-TRACK SYSTEM TWO

KLEEN-RITE TOUCHLESS CHEMICALS



PRODUCT	PART #	GALLONS	DESCRIPTION	DILUTION	COLOR	SCENT
Kleen-Track 2A Low pH	KRKT2A5*	5	A phosphoric, acid-based liquid presoak formulated for use as a first step in a two-step Touchless Wash Process.	75-120:1	Light Golden	Fruit/Gum
	KRKT2A30*	30				
	KRKT2A55*	55				
Kleen-Track 2B High pH	KRKT2B5*	5	A high pH presoak formulated for use as a second step in a two-step Touchless Wash Process. The product of choice for washes utilizing a single step pre soak.	64-90:1	Yellow/Green Transparent	-
	KRKT2B30*	30				
	KRKT2B55*	55				

KLEEN-TRACK SYSTEM THREE

KLEEN-RITE TOUCHLESS CHEMICALS



PRODUCT	PART #	GALLONS	DESCRIPTION	DILUTION	COLOR	SCENT
Kleen-Track 3A Low pH	KRKTNC5	5	A non-corrosive first step presoak that contains a blend of surfactants, solvents and citric acid.	75-120:1	Transparent	-
	KRKTNC30	30				
	KRKTNC55	55				
Kleen-Track 3B High pH	KRRT5	5	A non-corrosive high pH liquid presoak. Formulated for use as a second step in a two-step Touchless Wash Process or may be used as a presoak in a single step application.	64-90:1	Transparent	-
	KRRT30	30				
	KRRT55	55				

KLEEN-SEAL

KLEEN-RITE TOUCHLESS CHEMICALS



PRODUCT	PART #	GALLONS	DESCRIPTION	DILUTION	COLOR	SCENT
Kleen-Seal with Polymers®	KR5300	5	Highest quality Automatic Beading Sealant & Protectant. The only product that gives the lasting protection of Polymers. Fresh piña colada scent.	120-240:1	Blue Transparent	Piña Colada
	KR30300	30				
	KR55300	55				

HAZARDOUS MATERIAL. A \$36.00 FEE MAY BE ADDED TO YOUR ORDER.



1-800-233-3873 • (717) 684-6721 • FAX (800) 446-0495 • KLEENRITE.COM

681

CHEMICALS

KLEEN-RITE CORP.

KLEEN-RITE AUTOMATIC - POWDERS & LIQUIDS



SUPER POWER WASH KIT KLEEN-RITE POWDERS

- 100 lbs.
- To use, mix 30 pounds of powder with the included 5 gallons of liquid to yield 55 gallons of cleaning chemical. High sudsing, high pH detergent.
- **DILUTION:** 20-60:1

P01175



SUPER KLEEN POWDER KLEEN-RITE POWDERS



- Fully formulated, highly soluble alkaline powder
- 50 lbs
- **DILUTION:** 20-60:1

KRSK10



SUPER WASH KLEEN-RITE POWDERS



- A fast acting powder designed to emulsify road film and oily dirt
- **DILUTION:** 20-60/1

KRWW50

50 lbs.

KRWW100

100 lbs.



IN-BAY TURBO POWDER KLEEN-RITE POWDERS

- Powdered Alkaline pre-soak provides excellent cleaning with easy mixing
- Great even foam coverage
- New formula is non-corrosive with super fast acting surfactants
- 50 lbs. of powder makes 55 Gallons
- **DILUTION:** 36-64:1

KRTP50



BUG MASTER

KLEEN-RITE AUTOMATIC PRODUCTS

- Citrus based bug remover that quickly removes bugs and bug juices from grills, windshields and painted surfaces. Use in automatic car washes as a bug pass or in tunnel applications as a prep soap. This product has been field tested for several years with fantastic results.
- **DILUTION:** 18-24:1

KR5500

5 Gallons

KR30500

30 Gallons

KR55500

55 gal.



KLEEN TUNNEL

55 GALLON HIGH PERFORMANCE CHEMICALS FOR TUNNEL APPLICATIONS

KLEEN-TUNNEL

NAME	PRODUCT	PART #	GALLONS	DESCRIPTION	DILUTION	COLOR	SCENT
Tunnel-Prep	Presoak	KRT55200	55	Fast acting prep gun or pre-soak arch detergent breaks down road film & bugs quickly.	48-80:1	Green	Citrus
Tunnel-Glide	Lubricating Soap	KRT55201	55	High foaming action plus super lubricants cleans cars quickly and rinses freely to reduce streaking. Designed to work with all cloth systems.	160-240:1	Clear	-
Lo-pH Tunnel-Glide	Lo-pH Lubricating Soap	KRT55202	55	High foaming action plus super lubricants, specially formulated at a low pH to help clean the surface of the vehicles and prepares the surface for drying agents & polish waxes to perform to their peak performance. HF Free product.	90-150:1	Gold	-
Tunnel-Shield	Clear Coat Polish	KRT55300	55	Concentrated high foaming conditioning polish produces a high lustre shine on all clear coat surfaces.	80-120:1	Red	Tropical
Tunnel-Towel	Drying Agent	KRT30301	30	Carnauba based drying agent provides quick beading action to reduce drying time; sets up fast to keep up with line speed.	64-100:1	Green	-
		KRT55301	55				





Featured Products



BLACK BEAUTY SIMONIZ



- Brush application.
 - Long-lasting shine with powerful UV protection.
- A water-based dressing. Easy to work with. Perfect for in-line tunnel tire shiners.

\$162.63	PA5588	5 Gallons
\$978.94	DR30588	30 Gallons
\$1,742.58	DR55588	55 Gallons

Tire Shiner



PAD PERFECT SIMONIZ



- Pad application.
 - Used in pad style tire shine systems.
- Ready to use formula application rate of 1.5 to 2oz per vehicle for a uniform sheen

\$192.98	PA5220	5 Gallons
\$1,116.20	DR30264	30 Gallons
\$1,858.04	DR55264	55 Gallons

DILUTION RTU



PRISM TIRE DRESSING SIMONIZ



- Hand application or with Simoniz Tire Shiner equipment
- High gloss, water-based "gel" dressing
- UV protection
- Slightly viscous gel that clings to tires better than most water-based tire dressings

\$142.55	PA5503	5 Gallon
\$865.60	DR30501	30 Gallon
\$1,520.19	DR55501	55 Gallon



SHOW TIME SIMONIZ

- Specially blended solvent-based formula
- Multiple silicones impart long-lasting shine
- Great wet-look results - high gloss
- Fast drying

\$151.97	PA5530	5 Gallon
\$1,615.12	DR55535	55 Gallon



VINYL DRESSING SIMONIZ

- Great for vinyl, rubber, and plastic
- Use on exterior and interior surfaces
- Nourishes and revitalizes dull surfaces on vehicles

\$30.89	JS4100	1 Gallon
\$152.29	PA5525	5 Gallon



BLACK BACK SIMONIZ

- High-gloss, solvent-based formula
- Rejuvenates exterior black rubber components such as wheel openings, trims, and moldings
- Gives a new look to any vehicle

\$31.51	JS3267	1 Gallon
\$145.06	PA5505	5 Gallon
\$1,453.83	DR55506	55 Gallon

CHEMICALS



SIMONIZ® CHEMICALS



EXTREME SHINE

SIMONIZ

- Designed for use on both tires and exterior trim like faded bumpers or wheel openings

\$149.24	PA5554	5 Gallon
\$924.84	DR30554	30 Gallon
\$1,588.63	DR55554	55 Gallon



ALL SEASON TIRE SHINE

SIMONIZ

- All Season Tire Shine is a safe, water-based tire dressing that will not freeze!
- For the Consumer: A non-greasy, like-new clean slick finish to all tires.
- For the Car Wash Owner: A non-freezing product for your self-serve bays that will stay operating and produce profits throughout the winter months.

\$148.72	PA5420	5 Gallons
-----------------	---------------	-----------



PAD PERFECT

SIMONIZ



- Pad Perfect is perfectly matched to the porosity of SIMONIZ® Tire Shiner Pads, creating the perfect environment for dressing oversized and low profile tires.
- Durable shine, eliminates labor, lasts longer, and stops hazardous slipping. Pad Perfect is a great addition to your car wash soap supply.
- RTU: Apply 1.5 - 2.0 oz per application

\$192.98	PA5220	5 Gallons
\$1,116.20	DR30264	30 Gallons



NATURAL SHINE TIRE DRESSING

SIMONIZ

- Oil and Silicone Free
- Shiny, like-new tires!
- For use in Simoniz Tire Shiner System
- Compatible with automatic dressing applicators

\$183.44	PA5412	5 Gallon
-----------------	---------------	----------



BLACK & BLUE TIRE

SIMONIZ

- Easy-to-apply silicone fluid that imparts great gloss and rich luster
- Silicone based fluid formula

\$131.41	PA5408	5 Gallon
\$1,341.97	DR55408	55 Gallon



BLACK ICE TIRE DRESSING

SIMONIZ

- A thixotropic water-based dressing
- High gloss shine
- Black Ice "swells" the applicator pad like gel to prevent dripping
- Ready to use, no dilution necessary

\$163.11	PA5276	5 Gallon
-----------------	---------------	----------



IN AND OUT TIRE DRESSING

SIMONIZ

- The thick, water based formula is great for improving the appearance of tires, trim, dashboards, and even leather.
- Apply with a squeeze applicator, sold separately

\$118.60	PA5401	5 Gallon
-----------------	---------------	----------



BAY SHINE TIRE DRESSING

SIMONIZ

- A tire shine with a solvent base. Formulated for use in the Simoniz Self Serve Tire Shine System. Leaves a deep black shine on tires.
- Dilution: Ready To Use

\$139.51	PA5425	5 Gallon
-----------------	---------------	----------



RESINATE SILICONE RUBBER & TIRE

SIMONIZ

- Solvent-based silicone formula with blue transparent appearance and a citrus scent
- Ready for application, no dilution- in the tire dressing applicator. For automatic conveyor tunnel.

\$33.19	JS1536	1 Gallon
----------------	---------------	----------

SIMONIZ® CHEMICALS & WHEEL CLEANER



VISION CLEAR - TOTAL SURFACE PROTECTION FOR SELF-SERVE

SIMONIZ



- Not just for windshields any more! Use as an economical replacement for other popular windshield/total surface protectants!
- Unscented, undyed Vision Clear available.
- **DILUTION:** 50:1

PA5541	5 Gallons
DR30500	30 Gallons



DESALT

SIMONIZ



- "DeSalt" is a specially blended detergent designed to directly neutralize the activity of these new road de-icing treatments right down to the pores of metals, painted and other hard surfaces giving you the cleanest, shiniest and driest cars
- Great winter season replacement for bug cleaners
- Alters adverse effects of road salt
- Effectively removes salt residue and contaminants from pores in metal and hard surfaces
- Counteracts the activity of salt brines and rock salt on vehicle surfaces
- Has anti-corrosive properties
- Salt neutralizer with moderate foam level and helps prevent rust

PRICE	PART #	SIZE	DILUTION
\$57.65	PA5568	5 Gallons	90-128:1
\$237.23	DR30568	30 Gallons	
\$416.75	DR55568	55 Gallons	



DON'T BUG ME BUG REMOVER

SIMONIZ



- SIMONIZ® Don't Bug Me is a liquid pre-spray used to remove bugs. Don't Bug Me is best applied to the vehicle under low volume and low pressure. After dwelling for a short period of time, just rinse Don't Bug Me off your vehicle and the bugs will easily wash away! Don't Bug Me is a great addition to your car wash soap supply. Add SIMONIZ® Don't Bug Me to your car wash supplies today!
- **DILUTION:** 3-7:1

\$42.31	PA5509	5 Gallons
\$262.63	DR30514	30 Gallons
\$387.00	DR55514	55 Gallons



VISION CLEAR IN-BAY SELF SERVE SIGN

SIMONIZ

- Polystyrene material
- 18" x 24"

\$27.76 **SIKR205**



SIGNS

DESALT SIGNAGE

- Polystyrene material

\$12.33	SIKR090	9" x 16" Bay Sign
\$62.12	WMS190	28" x 44" Windmaster

Classic Style Menu Strip



Turn selector knob to DE-SALT. Saturate entire vehicle with DE-SALT working from top to bottom. Rinse off vehicle, then turn selector knob to PRESOAK.



Turn selector knob to DE-SALT. Apply low pressure DE-SALT to entire vehicle. Apply DE-SALT to remove winter road salt prior to PRE-SOAK.

Deluxe Style Menu Strip



Classic Coinbox Decal



Deluxe Coinbox Decal

Windmaster Sign
Insert 28" x 44"
Sign Stand
sold separately

IN-BAY CIRCLES AND MENU STRIPS

DESALT SIGNAGE

\$4.73	CMPST19	DeSalt Menu Strip
\$0.85	CB04619	DeSalt New Style Circle
\$0.64	CB034619	DeSalt Old Style Circle
\$0.64	CB034619BL	DeSalt Bilingual Circle

CHEMICALS

PET WASH CHEMICALS

DOG WASH



DOG WASH CHEMICALS

KLEEN-RITE

PRODUCT NAME	PART #	GAL.	DESCRIPTION	DILUTION	COLOR	SCENT
Tearless Shampoo (RTU)	PTW215	5	Clean Rinsing. Adds shine and luster.	RTU	Transparent Blue/Green	Fresh Fragrance
	PTW210	1				
Tearless Shampoo (Concentrate)	PTW200	5	Clean Rinsing. Adds shine and luster.	30-40/1	Light Pink	Fresh Herbal Fragrance
	PTW233	1				
Creme Conditioner	PTW202	5	Clean fruity scent lasts for weeks. Reduces tangles & mats. Conditions coat to a brilliant sheen.	8/1	-	Fresh Fragrance
	PTW235	1				
Veterinary Grade Shampoo	PTW231	5	Mild shampoo that thoroughly cleans hair and relieves discomfort caused by mild skin irritation.	RTU	-	Mint
	PTW237	1				
De-Skunk	PTW232	5	Fast acting, removes skunk odor from pets, people, clothing and carpets.	RTU	Transparent Amber	Fresh Fragrance
	PTW238	1				
Oatmeal Treatment	PTW201	5	Mild shampoo that thoroughly cleans hair and relieves dry, itchy skin.	RTU	-	Fruity
	PTW234	1				
Tub Cleaner	PTW230	5	This product is a multi-purpose, neutral pH detergent especially formulated to clean and deodorize hard surfaces in contact with household pets. NOT FOR USE ON ANIMALS.	RTU		Clean/Fresh
	PTW236	1				

CHECK OUT

OUR DOG WASH

**SELF SERVE EQUIPMENT SECTION
FOR YOUR CHEMICAL SET UP NEEDS!**

(PAGE 455)



TRIPLE FOAM



TRIPLE FOAM KLEEN-RITE



PRICE	PRODUCT	PART #	COLOR	SCENT	DILUTION	TIP
\$98.98	Triple Foam Polish	KRC281	Blue	Cherry	300-600:1	Yellow
\$98.98		KRC283	Yellow	Cherry	300-600:1	Yellow
\$98.98		KRC282	Pink	Cherry	300-600:1	Yellow
\$99.37	Triple Foam Detergent	KRC284	Blue	Cherry	300-600:1	Yellow
\$99.37		KRC286	Yellow	Cherry	300-600:1	Yellow
\$99.37		KRC285	Pink	Cherry	300-600:1	Yellow

LOW PH TRIPLE FOAM CONDITIONER

KLEEN-RITE



PRICE	PRODUCT	PART #	COLOR	SCENT	DILUTION	TIP
\$111.63	Low pH Triple Foam Conditioner	KRC275	Blue	Fruity	300-600:1	Yellow
\$111.63		KRC277	Yellow	Fruity	300-600:1	Yellow
\$111.63		KRC276	Pink	Fruity	300-600:1	Yellow



TRIPLE FOAM SIMONIZ



PRICE	PART #	DESCRIPTION	DILUTION
\$86.51	PAS5035	Polish - Poly Clear Pink	150-200:1
\$86.51	PAS5036	Polish - Poly Clear Green	150-200:1
\$86.51	PAS5037	Polish - Poly Clear Blue	150-200:1
\$86.51	PAS5039	Polish - Poly Clear Yellow	150-200:1
\$56.19	PA5236	Conditioner - Pink	175-225:1
\$56.19	PA5235	Conditioner - Blue	175-225:1
\$56.19	PA5237	Conditioner - Yellow	175-225:1



TRIPLE FOAM JBS INDUSTRIES



PRICE	PART # 5 GAL	DESCRIPTION	DILUTION
\$116.52	JBCGF5B	Polish - Blue	120-300:1
\$116.52	JBCGF5P	Polish - Pink	120-300:1
\$116.52	JBCGF5Y	Polish - Yellow	120-300:1
\$115.30	JBCGFDETB	Detergent - Blue	120-240:1
\$115.30	JBCGFDETP	Detergent - Pink	120-240:1
\$115.30	JBCGFDETY	Detergent - Yellow	120-240:1

Additional Glow Foam® products available on page 704



FOAM GUNS & FOAM GUN PARTS HAMEL MANUFACTURING CO.



STAINLESS STEEL RUBBER COATED HAMEL MANUFACTURING CO.

\$24.07	GUFBKSS	Black
\$24.07	GUFRSS	Red
\$24.07	GUFBLSS	Blue

RUBBER COATED HAMEL MANUFACTURING CO.

\$18.14	GUFBK	Black
\$18.14	GUFR	Red
\$18.14	GUFBL	Blue

NOZZLE PROTECTORS HAMEL MANUFACTURING CO.

\$2.36	NPHRBK	Black
\$2.36	NPHRR	Red
\$2.36	NPHRBL	Blue

FOAM GUN NOZZLE SPRAYING SYSTEMS CO.

\$6.38	SN5040VSS2
--------	------------



6" STAINLESS STEEL WAND HOLDER HAMEL MANUFACTURING CO.



- Stainless Steel - Rolled Entry
- Stainless Steel Mounting Bracket
- No Sharp Edges Exposed
- Made in America

\$22.78	WHS06
---------	-------

CHEMICALS

ANTI-FREEZE CHEMICALS

USE THIS HANDY HYDROMINDER TIP FREEZE CHART

PROTECTS FROM FREEZING TO:	TIP COLOR
30°F to 20°F	Red
20°F to 10°F	Beige
10°F to 0°F	Black
Lower than 0°F	No Tip



WINTER ANTI-FREEZE KLEEN-RITE



KLEEN-RITE CORP.



PRODUCT	PART #	GALLONS	COLOR	DESCRIPTION	DILUTION
Kleen-Rite Anti-Freeze Detergent	KR5AF*	5	Red	High foaming, cherry scented, winter foam brush detergent.	By Temp
	KR30AF*	30	Red		
	KR55AF*	55	Red		
	KR5AF-W*	5	White	High foaming, non-scented, winter foam brush detergent.	
	KR30AF-W*	30	White		
KR55AF-W*	55	White			
Kleen-Rite Anti-Freeze Triple Foam	KRATF5P*	5	Pink	Winter Tri-Foam Detergent for both self-serve and automatic triple foam applications.	By Temp
	KRATF5Y*	5	Yellow		
	KRATF5B*	5	Blue		



WINTER ANTI-FREEZE SIMONIZ



PRODUCT	PART #	GALLONS	COLOR	DESCRIPTION	DILUTION
Triple Foam Detergent Anti-Freeze	PA5222*	5	Blue	Specially formulated Tri-Foam Detergent with vivid colors. Will provide both excellent cleaning & visual appeal for both self-serve and automatic triple foam applications.	By Temp
	PA5223*	5	Red		
	PA5224*	5	Yellow		



WINTER ANTI-FREEZE JBS INDUSTRIES



PRODUCT	PART #	GALLONS	COLOR	DESCRIPTION	DILUTION
Winter Foaming Brush	JBAF5*	5	Pink	High-foaming foam brush detergent. Effective up to -50°F. Cherry fragrance.	By Temp

Protect yourself from dangerous freezing temperatures by using Simoniz, JBS, and Kleen-Rite anti-freeze chemicals. These specially-formulated detergents offer the same cleaning power and visual appeal as regular triple foam, but they also have added anti-freeze ingredients that keep your self-serve or automatic wash operating at full strength in harsh, below-freezing temperatures. Using anti-freeze detergents eliminates the risk of equipment damage and malfunctions caused by low temperatures. Available in a variety of bright colors, so you can offer the impressive triple foam experience while also having the security of anti-freeze properties in your soap!

YOU GET TWO 2½ GALLON JUGS!



- Complete Convenience - Kleen-Pak easy-to-store 2.5-gallon jugs pack premium cleaning power and unbeatable shine into a compact container.
- Store Kleen-Pak 2.5-gallon jugs on a shelf and free up the 55-gallon drum footprint to create a cleaner more spacious equipment room
- Anyone can easily handle, store and refill
- Using smaller 2.5-gallon containers translates into savings on shipping, container cost and blending expenses.
- Each Kleen-Pak 5-gallon refill pack contains two 2.5-gallon easy-pour jugs

PRESOAK				
TYPE	PART #	COLOR	SCENT	DESCRIPTION
High pH	KRKP5210	Yellow	-	Highly concentrated, heavy duty, high pH liquid car wash presoak. Effective in every application, especially powerful for touch-free washing. Won't charge the car's surface and increases rinsability and shine. Can be used as a single step presoak or as a two-step process in combination with low pH products.
Low pH	KRKP5220	Green	-	Hyper concentrated presoak specifically for use in a 2-step Low pH/High pH wash process. Contains high quality low pH acids that emulsify, neutralize and loosen dirt and grime in a high pressure wash system. Significantly reduces eyebrows on windshields.
High Pressure	KRKP5202	Clear to Amber	Bubble Gum	This ultimate high pressure detergent concentrate combines high suds, alkalinity and visual appeal for superior cleaning. Suitable for tunnel and self-serve washes.
Fragrant Presoak	KRKP5200	-	-	Highly concentrated, heavy duty, high pH liquid car wash presoak with fragrance. Effective in every application and especially for the self-serve car wash.
LUBRICANT/DETERGENT				
TYPE	PART #	COLOR	SCENT	DESCRIPTION
Body Shampoo	KRKP5207	Clear to Amber	-	Premium foam lubricating detergent, designed for all cloth washes, produces a thick and rich lather and provides excellent cleaning and rinse ability. This highly concentrated lubricating soap reduces damage claims, such as mirrors, antennas, and license plates.
Foam Brush	KRKP5203	Red	Cherry	Hyper concentrated lubricant detergent with cleaning agents for use in self-serve brush application.
Pink Foam Brush	KRKP5203C	Pink	Cherry	Hyper concentrated lubricant detergent with cleaning agents for use in self-serve brush application.
PROTECTANT				
TYPE	PART #	COLOR	SCENT	DESCRIPTION
Clearcoat Conditioner	KRKP5305B	Blue	Bubble Gum	High concentrate pH balanced surface conditioner with cleaning agents and protectants is available in pink, blue and yellow. Applied through foamers.
	KRKP5305P	Pink		
	KRKP5305Y	Yellow		
Sealer	KRKP5303	Red	Cherry	High concentrate polymeric-based cherry-scented protectant maintains and preserves all car surfaces. Provides a visible high gloss appearance and protective coating. Also great in a self-serve application.
AquaGuard	KRKP5310	Amber	-	Maximum protection on all vehicle surfaces with an optimized water repellent formula. Perfect for use on glass, chrome, plastic trim and paint.
DRYING AGENT				
TYPE	PART #	COLOR	SCENT	DESCRIPTION
Drying Agent	KRKP5300	Blue	-	Super concentrate drying agent creates instantaneous water break to achieve optimum blower efficiency and a drier car. Reduce labor costs with minimum wipe down time.
TIRE CLEANERS				
TYPE	PART #	COLOR	SCENT	DESCRIPTION
Wheel & Tire	KRKP5400	Fluorescent Yellow	-	High concentrate, non-corrosive product for cleaning all types of wheels (including chrome, aluminum, and magnesium) and whitewall tires. Safely removes brake dust and makes whitewalls white again. Simply spray on and rinse off. This product also give you a visual green look. Great for self-serve.
BUG REMOVER				
TYPE	PART #	COLOR	SCENT	DESCRIPTION
Bug Buster	KRKP5500	Green	-	High-concentrate bug remover.

EASY-KLEEN STATION FOR KLEEN-PAK CONCENTRATES

KLEEN-RITE CHEMICALS



- Short on space? Large, round, 55-gallon drums can be very difficult to handle, store, maneuver around, and use in your car wash equipment room. Now there's a better, space-saving way to store your soaps and chemicals with the Easy-Kleen Station!
- The Easy-Kleen Station is designed for use with our Kleen-Pak hyper concentrates (sold separately). Our 2.5-gallon Kleen-Pak jugs are super concentrated and compact to save you plenty of space! Plus, the rectangular design of the Easy-Kleen storage container lines up perfectly with other rectangular containers for a small footprint and superior organization.
- In addition, the Easy-Kleen storage container features easy-to-read markings on the label for accurate measurements. This storage and measurement station is an easy way to make your equipment room cleaner and more efficient!
- Saves space in your equipment room | Easy to install, maintain, handle, store and refill | No heavy drums
- Measurement markings on label for accuracy
- Unique top pierces induction-sealed containers for easy and automatic product delivery
- Designed for use with 2.5-gallon compact Kleen-Pak hyper concentrates
- 15½" W x 17½" D x 24¾" H

\$148.33	KRKP1000	Easy-Kleen Station
\$41.91	KRKP1000-BRKT	Galvanized Steel Wall Mounting Bracket For Easy-Kleen Station

CHEMICALS



SIMONIZ® CHEMICALS



PRIME PAK SIMONIZ

- SIMONIZ® brings you a surfactant system that is designed to be environmentally considerate, more stable, and biodegradable than ever before, in a compact package.
- Prime Pak is a true concentrated system, with formulations containing little-to-no water, reducing shipping weight and necessary storage space.
- Less packaging means less waste after use. Concentrated formulation means no more heavy drums to move around your site, or work around in tight equipment room.



PRESOAK		
Low pH	PP54002	First step presoak for in-bay automatics. A blend of mild but effective organic acids, water soluble solvents and both cationic and non-ionic surfactants.
High pH	PP54013	Amazing second step presoak that works synergistically with LPH. A unique, high pH blend of alkaline builders, chelating agents, water softeners, solvents and wetting agents.
LUBRICANT/DETERGENT		
Foam Brite	PP53040	High foaming long lasting "show foam" with excellent cleaning and lubricity for IBA friction systems.
High Pressure Detergent	PP53005	SIMONIZ® Prime Pak High Pressure Detergent is a highly concentrated blend of surfactants that loosens and removes road film in high pressure prep wands and self-service bays.
PROTECTANT		
Clear Coat Sealer	PP53052	A highly concentrated and very economical Piña Colada scented clear coat sealant. Clear Coat Sealer quickly de-foams and disperses water for a dry and spot-free finish.
Triple Foam Polish	PP53060	Blue
	PP53070	Red
	PP53075	Yellow
These amazing foam polishes are highly visual and will fill your bays with a strong cherry scent. They possess quick flash foam for visual appeal but rinse freely and bead up quickly when followed with Clear Coat Sealer.		
DRYING AGENT		
Drying Agent	PP53020	Highly concentrated drying agent that provides superior beading and water break. May be applied to vehicle under low or high pressure.
TIRE CLEANERS		
Presoak and Wheel Cleaner	PP53045	 Terrific alkaline presoak that can be used in a one-step wash process or as a second step presoak. Excellent in both hard and soft water, Prime Pack Presoak and Wheel Cleaner uniquely blends high alkaline builders, wetting agents and surfactants in a highly synergistic blend.



DID YOU KNOW...

You're tight on space and don't have time to blend powders – but you need chemistry that works. Prime Pak is a revolutionary rack and funnel fill system that uses highly effective concentrated chemicals. Prime Pak is ideal for in-bays, convenience store car washes, and small equipment rooms.



SIMONIZ® CHEMICALS



CHERRY PINK BUBBLES (MAGIC) SIMONIZ



- High sudsing liquid foam brush detergent that produces a visually appealing cherry scented foam
- **DILUTION:** 75-120:1

PA5242	5 Gallon
DR55260	55 Gallon



ULTRA SIMONIZ



- High foaming, high pH, high-pressure soap
- **DILUTION:** 75-120:1

PA5248	5 Gallon
DR55275	55 Gallon



TRUE SIMONIZ



- Outstanding liquid that performs well in cold water - rinses easily
- **DILUTION:** 60-120:1

PA5501	5 Gallon
DR55503	55 Gallon



SUPREME SIMONIZ



- Finest quality, highest sudsing detergent. Combines premium cleaning ability with high suds level for excellent visual effect.
- **DILUTION:** 150-200:1

PA5211	5 Gallon
DR55210	55 Gallon

LIQUIDS SIMONIZ

PRODUCT NAME	PART #	GAL- LONS	DESCRIPTION	DILUTION
Blue Liquid Pre-Spray	PA5215	5	Fabulous liquid pre-spray that is neutral. This unique blend of wetting agents quickly penetrates and solubilizes road film. Rinses freely.	60-100:1
	DR55214	55		
Body Bath	PAS5011	5	High foaming, concentrated brush and pad detergent provides excellent lubricity. For direct feed or through a foamer.	100-200:1
	DRS55051	55		
Brush with Ease	PA5209	5	High level of lubricity and foam characterizes this premium brush liquid. The brush glides over the car.	75-125:1
	DR55208	55		
Cherry Foam Deluxe	PA5239	5	High sudsing, concentrated liquid foam brush detergent that's visually appealing and cherry scented.	150-200:1
	DR55246	55		
Fantastic Foam	PA5203	5	High quality foamy detergent for foamy brushes. Our most popular.	60-120:1
	DR55202	55		
Film Fyter	PA5201	5	Heavy duty alkaline (non-caustic) liquid for use as a pressure wash detergent. Used in the right dilution, it will cut through film, especially in hot water.	60-120:1
	DR55200	55		
Glide	PA5207	5	Liquid presoak detergent combining alkaline and solvent based ingredients that make it effective against oil based road film.	60-120:1
	DR55280	55		
Lemon Foam Deluxe	PA5229	5	Highest quality foamy brush and automatic soap with a lemon scent.	100-200:1
	DR55230	55		
Liquid Power Wash (Appeal)	PA5233	5	A unique, excellent high pressure washing liquid that has the outstanding cleaning abilities usually found only in powder. Same as Appeal.	60-150:1
	DR55234	55		
Pink Bubbles (was Magic)	PA5225	5	When applied through a compressed air foamer, it will create bright pink foam for outstanding visual appeal.	75-120:1
	DR55232	55		
Super Foam	PA5205	5	High sudsing and ammoniated for extra cleaning. Hand bay or tunnel use.	100-200:1
	DR55204	55		
Foam Additive	PA5255	5	Highly concentrated foam additive that increases the power of concentrated detergents	As Needed
MC Liquid	PA5288	5	Additive formulated to enhance the cleaning ability of Alkaline detergents. MC Liquid is a Butyl-based neutral pH cleaner containing the naturally occurring solvent d'Limonene.	-

CHEMICALS



SIMONIZ® TROPICAL BAY HYPER PAK CONCENTRATES

SIMONIZ® self-serve Tropical Bay concentrated chemical products boost customer appeal with exciting colors and exotic scents to provide self-service car wash customers with a great in bay experience while using the car wash. Not only are their cars clean and shiny but they are also exposed to a myriad of their favorite scents while washing their cars. Tropical bay chemicals also deliver the results you need with outstanding dilution and cleaning ability.



PURPLE PASSION PRESOAK SIMONIZ HYPER PAK CONCENTRATES

- Formulated to break down stubborn road film at high and low pressure
- **DILUTION:** 200-300:1
- **TIP:** Yellow
- **COLOR:** Purple
- **SCENT:** Grape

TB2950 5 Gallon



BANANA PEEL FOAMY BRUSH SOAP SIMONIZ HYPER PAK CONCENTRATES

- **DILUTION:** 300-600:1
- **TIP:** Yellow
- **COLOR:** Yellow
- **SCENT:** Banana

TB2220 5 Gallon



ORANGE SLICE FOAMING TIRE CLEANER SIMONIZ HYPER PAK CONCENTRATES

- **DILUTION:** 12-30:1
- **TIP:** Blue or Tan
- **COLOR:** Orange
- **SCENT:** Citrus

TB4400 5 Gallon



MELON MANIA FOAMY BRUSH SOAP SIMONIZ HYPER PAK CONCENTRATES

- **DILUTION:** 300-600:1
- **TIP:** Yellow
- **COLOR:** Bright Green
- **SCENT:** Watermelon

TB2300 5 Gallon



BUBBLE BURST FOAMY BRUSH SOAP SIMONIZ HYPER PAK CONCENTRATES

- **DILUTION:** 300-600:1
- **TIP:** Yellow
- **COLOR:** Hot Pink
- **SCENT:** Bubble Gum

TB4250 5 Gallon



VANILLA SHAKE HIGH PRESSURE DETERGENT SIMONIZ HYPER PAK CONCENTRATES

- **DILUTION:** 600-900:1
- **TIP:** Pink or Purple
- **COLOR:** White
- **SCENT:** Vanilla

TB4200 5 Gallon



BLUE LAGOON FOAMING WAX SIMONIZ HYPER PAK CONCENTRATES

- **DILUTION:** 600-900:1
- **TIP:** Pink or Purple
- **COLOR:** Blue
- **SCENT:** Piña Colada

TB5000 5 Gallon



SIMONIZ® KLEER KOTE SUPER CONCENTRATES



VERY CHERRY FOAM BRUSH SOAP

SIMONIZ KLEER KOTE SUPER CONCENTRATES



- **DILUTION:** 600-900:1
- **TIP:** Pink or Purple
- **COLOR:** Pink
- **SCENT:** Cherry

KKB184 5 Gallons



SUPER SOAK FOAMY PRESOAK

SIMONIZ KLEER KOTE SUPER CONCENTRATES



- **DILUTION:** 200-300:1
- **TIP:** Yellow
- **COLOR:** Yellow
- **SCENT:** Pine

KKB183 5 Gallons



BRITE WHITE FOAMING TIRE/WHEEL CLEANER

SIMONIZ KLEER KOTE SUPER CONCENTRATES



- **DILUTION:** 12-30:1
- **TIP:** Blue or Tan
- **COLOR:** Green
- **SCENT:** Spearmint

KKB181 5 Gallons



BODY BATH HIGH PRESSURE SOAP

SIMONIZ KLEER KOTE SUPER CONCENTRATES



- **DILUTION:** 600-900:1
- **TIP:** Pink or Purple
- **COLOR:** White
- **SCENT:** Citrus

KKB180 5 Gallons



BLUE MAGIC FOAMING WAX

SIMONIZ KLEER KOTE SUPER CONCENTRATES



- **DILUTION:** 600-900:1
- **TIP:** Pink or Purple
- **COLOR:** Blue
- **SCENT:** Lemon

KKB179 5 Gallons

SIMONIZ® manufactures the best in self serve car wash chemicals. These super concentrated formulas are designed to offer great cleaning and shine while at the same time help save money by being concentrated to allow higher dilutions than typical car wash chemicals for the self serve bay. The chemists at SIMONIZ® have worked countless hours perfecting the products to not only be hard working, but also to provide the scents that your customers will love.

WAX APPLICATION



HOT WAX & SHINE EQUIPMENT ARCH

SIMONIZ

- A new and exciting concept! Simoniz® Hot Wax & Shine is a great new service with attention grabbing visual appeal! This unique application actually applies carnauba wax to the entire vehicle right inside your car wash tunnel.

SIMONIZ EQUIPMENT ARCH - FOR TUNNEL WASH WITH CONVEYOR ONLY

CALL SM11000

Includes: Simoniz Bubblizer Tunnel Application Arch, Dosatron Pumping Station, Yellow LED Lighting Package, Simoniz Hot Wax & Shine Electric Tunnel Sign, 30 Gallons of Simoniz Hot Wax and Shine, Driveway marketing Materials. Requires 119" H, 130" W and 28" Floor Clearance per side pillar.

HOT WAX & SHINE CHEMICALS

SIMONIZ



- Simoniz Hot Wax and Shine is a major profit driver at car washes across the country. By offering this specialized product, operators are able to increase the price of their top wash packages - or even create a new top package at a premium! Sold in a 5 gallon container.
- For conveyor tunnels and self serve car washes
- Apply through bubblizer arch (tunnel) or foam gun (self serve)
- Real carnauba wax!
- Protects and shines cars in one step

\$160.63 PA5338 5 Gallons

\$1,004.90 DR30338 30 Gallons



CHEMICALS



SIMONIZ® CHEMICALS

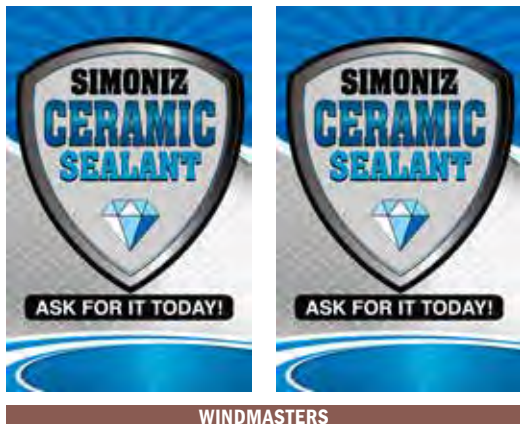

WINDMASTERS



CERAMIC SEALANT ARCH START-UP KIT

SIMONIZ

The Simoniz Ceramic Sealant Package One is a convenient kit that provides the equipment, ceramic sealant formula, and marketing tools to begin offering Simoniz Ceramic Sealant at your car wash today! Customers will be drawn in by the arch in your tunnel wash, which is complete with appealing full-color graphics and bright LED lights. To complement the arch, Windmaster signs and drum covers are also provided to catch customer attention. This Simoniz Ceramic Sealant kit also boasts a nozzle setup and Dosatron pumping station to effectively apply the ceramic coating. A 30-gallon drum of Ceramic Sealant is included in this package.

WHAT DOES SIMONIZ CERAMIC SEALANT DO?

Simoniz Ceramic Sealant is a breakthrough in the car wash industry; a highly hydrophobic formulation that includes a ceramic polymer. After being applied to a vehicle exterior, this formula chemically bonds with the paint to create a layer of durable protection. The sealant contains positively charged ions that are attracted to the negatively charged painted surface. This creates the hydrophobic coating that repels water.

The coating makes water bead effectively, protects from UV and oxidation, and makes it more difficult for grime and dirt to stick to the car surface. Lastly, the vehicle has a deep, clear, glossy shine that brings out the reflective properties of the paint and clear coat. Offers protection and shine for up to thirty days. Please call Kleen-Rite for a freight shipping quote.

DIMENSIONS: 168" Width x 136.34" Height ** Please visit our website and view the product brochure on this product for advanced dimensions

PACKAGE INCLUDES:

- Simoniz Ceramic Sealant full-color arch
- Fully lit LED panels
- Flashing diamonds
- 144 Watt blue LED top light
- Complete nozzle setup
- Dosatron pump station
- (2) Windmaster inserts
- (2) drum covers
- (1) 30 gallon drum of Simoniz Ceramic Sealant

PART #	PRODUCT	SIZE
SM11050	Ceramic sealant arch start-up kit	-
DR55317	Ceramic sealant protective formula	55 Gallons

PART #	PRODUCT	SIZE
DR30317	Ceramic sealant protective formula	30 Gallons
PA5317	Ceramic sealant protective formula	5 Gallons



SIMONIZ® CERAMIC SEALANT ACCESSORIES

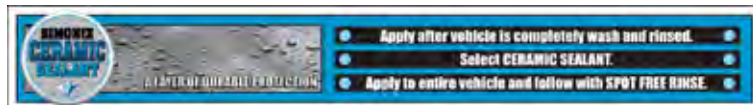

3" H X 22" W DELUXE MENU STRIP

DECALS

\$4.73 CMPST21



ROTARY CIRCLE DECAL SIGNS

\$0.85 CB04640



WINDMASTER SIGN INSERT SIGNS

- 28" x 44"
- Sign holder sold separately

\$90.94	WMS560	Windmaster
\$270.91	CH2002	Sign Holder



DRUM COVER FOR 55 GALLON DRUM SIGNS

- Fits on standard 55-gallon drums
- Features attractive graphics and enticing message

\$126.64 SMDC55



SIMONIZ® CHEMICALS

New!



CARBONITE ARCH START-UP KIT SIMONIZ

WHAT DOES SIMONIZ CARBONITE DO?

Graphene is a single layer of graphite, one atom thick. A carbon-based nanoparticle, graphene is arranged in a honeycomb structure. Because of its honeycomb structure and chemistry, graphene-infused Carbonite has a very high water contact angle (125°), a measure of wettability of a solid, compared to most coatings currently being applied. As a result, any moisture, like rainwater, will easily slide off thereby leaving minimal risk of any water evaporating on the surface and resulting in water spots. These water spots will etch into the coating and eventually into the paint finish. Also, our graphene-infused Carbonite is known for its thermal and electrical conductivity. Because of this property it can safely be described as "anti-static". For a vehicle, this means its coating will repel dust and other micro-particles, which is a real concern for most vehicle owners. Please call Kleen-Rite for a freight shipping quote.

BENEFITS: Improves surface hardness, glossy appearance, high slickness, hydrophobic, water-spot and moisture resistance, high chemical and abrasion resistance, extreme durability, long lasting, anti-corrosion against road salt and other contaminants, oxidation and uv protection

DIMENSIONS: 168" Width x 136.34" Height

PACKAGE INCLUDES:

- (1) Carbonite Arch with Strobe Lights
- (2) Windmaster Sign Inserts
- (2) Drum Covers
- (1) Carbonite, 30 Gallon

PART #	PRODUCT	SIZE
SM11060	Carbonite arch start-up kit	-
DR55319	Carbonite surface hardener	55 Gallons

PART #	PRODUCT	SIZE
DR30319	Carbonite surface hardener	30 Gallons
PA5319	Carbonite surface hardener	5 Gallons

SIMONIZ® CARBONITE ACCESSORIES



New!



WINDMASTER SIGN INSERT SIGNS

- 28" x 44"
- Sign holder sold separately

\$90.94	WMS562	Windmaster
\$270.91	CH2002	Sign Holder

New!



DRUM COVER FOR 55 GALLON DRUM SIGNS

- Fits on standard 55-gallon drums
- Features attractive graphics and enticing message

\$105.66	SMDC62
----------	--------



SIMONIZ® CHEMICALS



TOP-SELLING TOUCHLESS & CLOTH AUTOMATIC DETERGENTS



MAGIC LUSTRE

SIMONIZ CLOTH & AUTOMATIC DETERGENTS *



- High foaming liquid detergent formulated for use in a friction car wash. This product contains phosphoric acid and butyl solvent for added cleaning. Excellent visual appeal, free rinsing.
- **FOAMER DILUTION:** 150-200:1
- **IN-BAY AUTOMATIC DILUTION:** 150-225:1

PA5261*	5 Gallons
DR55240*	55 Gallons



PREP

SIMONIZ CLOTH & AUTOMATIC DETERGENTS *



- This presoak produces a medium level of foam and is free-rinsing. Prep can be used as a presoak in a friction conveyor wash or as a one-step presoak in a touch-free conveyor or high-pressure in-bay automatic wash.
- **DILUTION:** 60-200:1

PA5216*	5 Gallons
DR55270*	55 Gallons

TOUCHLESS & CLOTH AUTOMATIC DETERGENTS

SIMONIZ



PRODUCT	PART #	GALLONS	DESCRIPTION	DILUTION
Lustre Shine	PA5238	5	Very popular brush feed detergent. Outstanding oil emulsifier and solvent combination make this product especially suited for cloth. Good sudsing properties and free rinsing.	120-200:1
	DR55239	55		
Glide	PA5207	5	Liquid presoak detergent combining alkaline and solvent based ingredients make it effective against oil based road film.	60-120:1
	DR55280	55		
Magic Lustre NC	PA5265	5	High foaming, noncorrosive liquid detergent formulated for use in a friction car wash. Contains citric acid and butyl solvent for added cleaning. Excellent visual appeal and free rinsing.	120-200:1
	DR55245	55		
Magic Lustre Citrus	DR55244*	55	High foaming, liquid detergent formulated for use in a friction car wash. Contains citric acid for added cleaning. Excellent visual appeal and free rinsing. Contains phosphoric acid and butyl solvent for added cleaning.	Foamer 150-200:1 In-Bay Auto 150-225:1
Magic Lustre Melon	DR55247*	55	High foaming, liquid detergent formulated for use in a friction car wash. Excellent visual appeal and free rinsing. Melon scented. Contains phosphoric acid and butyl solvent for added cleaning.	Foamer 150-200:1 In-Bay Auto 150-225:1
Rustite Under Carriage Spray	PA5516	5	A rust inhibitor formulated for the undercarriage of a vehicle. Should be applied only to the undercarriage of a vehicle.	300:1
SIMONIZ® Plus	DR55254*	55	Can be used as a single step presoak in a touch free conveyor or high-pressure in-bay automatic wash process. It may also be used as a second alkaline step in a two-step touch free wash process.	200-400:1
Dri-Brite	PAS5010	5	All purpose drying results in superior water break and fast drying.	225-300:1
	DR555050	55		
Super Dri	PA5305	5	Our finest drying agent for those who demand the driest car possible. Great for low energy blowers and high speed conveyors.	225-300:1
	DR55304	55		
Spray Gloss	PA5301	5	Our backbone product, all-purpose spray shine. Used by all types of car washes. Great beading and guaranteed not to contain inexpensive kerosene. Minimum effect on windows.	200-300:1
	DR55300	55		

SIMONIZ® CHEMICALS



LEMON GLO SIMONIZ SPRAY SHINE & POLISHES



- Our most popular wax! Concentrated spray polish offers excellent drying and shining capabilities. Fragrant lemon scent offers excellent customer reinforcement.
- **DILUTION:** 200-300:1

PA5303	5 Gallons
DR55302	55 Gallons



POLY SEALANT SIMONIZ SPRAY SHINE & POLISHES



- Lemon-scented polymer silicone blend for premium wax programs. Applied under low pressure. Maximum gloss.
- **DILUTION:** 200-400:1

PAS5014	5 Gallons
DRS55054	55 Gallons

SPRAY SHINE & POLISHES SIMONIZ

PRODUCT	PART #	GAL.	DESCRIPTION	DILUTION
Coin Foamy Wax	PA5313	5	Unique spray wax that comes out of a standard pressure wand as a light foam. Breaks up as it hits the car. Lemon scented.	200-300:1
	DR55312	55		
Cherry Glo	PA5308	5	Cherry scented all-purpose self-serve spray polish. Provides excellent beading, apply high or low pressure.	200-300:1
	DR55305	55		
Poly Clear Blue	PAS5037	5	For triple foam. A visually appealing blue high foam polish that delivers a thick lather. Applied to the vehicle through a polish arch.	150-200:1
	DRS55061	55		
Poly Clear Green	PAS5036	5	For triple foam. A visually appealing green high foam polish that delivers a thick lather. Applied to the vehicle through a polish arch.	150-200:1
	DRS55062	55		
Poly Clear Pink	PAS5035	5	For triple foam. A visually appealing pink high foam polish that delivers a thick lather. Applied to the vehicle through a polish arch.	150-200:1
	DRS55064	55		
Poly Clear Yellow	PAS5039	5	For triple foam. A visually appealing yellow high foam polish that delivers a thick lather. Applied to the vehicle through a polish arch.	150-200:1
	DRS55063	55		
Pressure Polyglaze	PAS5013	5	Cherry-scented polymer spray is ideal as a second step in foam polish process or alone in premium wax program. Also great for self-serve bays.	225-350:1
	DRS55053	55		

TRI FOAM SPRAY SHINE & POLISHES SIMONIZ

PRODUCT	PART #	GAL.	COLOR	DESCRIPTION	DILUTION
Tri Foam Conditioner	PA5236	5	Pink	Ultra concentrated visually appealing high foaming conditioner formulated for clear coat finishes. Designed to clean and shine surface by utilizing surface active ingredients.	175-225:1
	DR30242	30			
	PA5235	5	Blue		
	DR30248	30			
	PA5237	5	Yellow		
	DR30249	30			
	DR30246	30	Green		
DR55258	55				
Poly Clear	PAS5035	5	Pink	A visually appealing high foam polish. This product will deliver a thick lather when applied to the vehicle through a polish arch with compressed air. Application should be followed up with a clear coat sealer.	150-200:1
	PAS5037	5	Blue		
	PAS5039	5	Yellow		
	PAS5036	5	Green		

ADDITIVES SIMONIZ

PRODUCT	PART #	GALLONS	DESCRIPTION	DILUTION
Foam Additive	PA5255	5	Highly concentrated foam additive that increases the power of concentrated detergents. SHOULD NOT be mixed with quaternary disinfectant or sanitizer.	As Needed
	DR55266	55		

CHEMICALS



SIMONIZ® CHEMICALS



BRAKE AWAY SIMONIZ WHEEL CARE



* HAZARDOUS MATERIAL

- A non-acidic brake dust and wire wheel cleaner that combines safety and performance. It is formulated with solvents and wetting agents to break the bond that holds brake dust.
- **DILUTION:** 2-10:1

PA5435*	5 Gallons
DR55516*	55 Gallons



GOLDEN FOAMING WHITEWALL SIMONIZ WHEEL CARE



* HAZARDOUS MATERIAL

- This liquid cleaner requires a compressed air foaming apparatus. Excellent clinging and cleaning.
- **DILUTION:** 4-10:1

PA5407*	5 Gallons
DR55406*	55 Gallons



WHITEWALL CLEANERS & WHEEL BRIGHTENERS

SIMONIZ

* HAZARDOUS MATERIAL

PRODUCT	PART #	SIZE	DESCRIPTION	DILUTION
Heavy Duty Whitewall Cleaner	BX5401*	50 lbs.	Very popular non-caustic powder. Excellent cleaning/degreasing. Will not harm aluminum. Use for coin-op whitewall systems.	2-4:1
	P01400*	100 lbs.		
Liquid Whitewall Cleaner	PA5405	5 Gallons	Outstanding ready-to-use whitewall cleaner. Applied by spray, brush, etc. Will not damage aluminum. May be diluted 1/1. Good for wash without CTA unit.	4-10:1
	DR55404	55 Gallons		
Wheel Brite	PAS5016*	5 Gallons	Cleans and brightens all wire wheels and rims. It can be applied on line with Wheel Brite applicator or manually. Doesn't contain hydrofluoric acid.	4-17:1
	DR55409*	55 Gallons		
X-tra HD Whitewall Cleaner	BX5412*	50 lbs.	Highly alkaline, best used with mechanical applicators. Can discolor aluminum.	2-10:1
	P01402*	100 lbs.		
Foamy White Wash	PA5430*	5 Gallons	Liquid caustic whitewall cleaner for use through CTA applicator. Effective on all types of tires. High foam allows for longer dwell time and added visual appeal.	4-10:1
	DR55430*	55 Gallons		
Platinum Wheel Cleaner	PA5517	5 Gallons	Rapid-acting acidic formula to quickly wash away rust, grease, dirt and pad dust from wheels and rims. Restores shine to wheels and wheel covers.	-
	DR55517	55 Gallons		



LAUNDRY SOAPS

SIMONIZ

PRODUCT	PART #	SIZE	DESCRIPTION	DILUTION
Liquid Laundry Soap	PA5286	5 Gallons	Outstanding cleaning and brightening. Safe for all washable fabrics.	1/2 - 1 Cup
	DR55286	55 Gallons		
Blue Label Laundry Detergent	BX5111	50 lbs.	Concentrated laundry powder. Suspends oils, grease, & dirt so they are not redeposited into laundry.	1/4 - 1/2 Cup
Red Label Laundry Detergent	BX5117	50 lbs.	Concentrated laundry powder. Suspends oils, grease, & dirt so they are not redeposited into laundry.	1/2 - 1 Cup
Liquid Bleach	DR55249	55 Gallons	Bleach	As Needed



SIMONIZ® CHEMICALS



WE STOCK A COMPLETE LINE OF SIMONIZ® PRESOAK POWDERS COVERING ALL TYPES OF APPLICATIONS INCLUDING CAR WASHING, TRUCK WASH AND POWER WASH INDUSTRIES.

Simoniz® powders clean very well, while at the same time are very economical by being less expensive to ship and handle at your location. Many car wash and truck wash locations rely on the Simoniz® powder chemical soaps everyday to clean many vehicles. Simoniz® powdered car wash detergents can be used for both friction and frictionless cleaning. In addition, powders are a great choice for friction full-service tunnel conveyors as high-pressure prep gun presoak.



CORRECT SIMONIZ POWDERS



HAZARDOUS MATERIAL

- Powdered alkaline presoak detergent containing the naturally occurring solvent D-Limonene. Very effective on oil based road film. Exhibits medium foam levels and is free rinsing.
- **DILUTION:** 40-60:1

BX5135*	50 lbs.
P01170*	100 lbs.



POWER SOLVE SIMONIZ POWDERS



HAZARDOUS MATERIAL

- Quality high pressure detergent. Outstanding performance in moderately hard water. Ideal 2nd step detergent in high volume washes. Free rinsing powder.
- **DILUTION:** 20-40:1

BX5122*	50 lbs.
P01102*	100 lbs.



SUPER POWER WASH SIMONIZ POWDERS



- Most popular, designed especially for electronic soap dispensers and self serve bays. Stays liquid when mixed.
- **DILUTION:** 40-60:1

BX5105	50 lbs.
P01104	100 lbs.



KLEEN POWER SIMONIZ POWDERS



- Finest quality. No free alkali. A must in hard water. Will eliminate scale problems.
- **DILUTION:** 40-60:1

BX5109	50 lbs.
P01108	100 lbs.

POWDERS SIMONIZ

PRODUCT NAME	PART #	LBS.	DESCRIPTION	DILUTION
Kleen Green	BX5115	50	High sudsing, powdered detergent pre-soak that can be used in a hopper type pre-soak system.	20-30:1
	P01116	100		
Power Plus	BX5101	50	Popularly priced high quality pressure cleaning powder.	40-60:1
Special Power Clean	BX5106	50	Product of choice in moderate hard water areas. Perfect balance between cleaning and softening.	40-60:1
	P01107	100		
Special Power CleanBlue	P01109	50	Product of choice in moderate hard water areas. Perfect balance between cleaning and softening. Blue in color.	40-60:1
Super Soak	BX5113	50	Excellent powdered detergent presoak. Medium suds level, moderate alkalinity.	40-60:1
	P01120	100		

CHEMICALS



SIMONIZ® CHEMICALS



BIG RIG
SIMONIZ SPECIALTY INDUSTRIAL PRODUCTS

TOP SELLER!

- Cuts through grease, road film, diesel smoke marks, and exhaust residue
- Also works as a highly effective degreaser, too!
- DILUTION: 128:1**

PA5545*	5 Gallons	*
DR55545*	55 Gallons	



ALUM BRITE
SIMONIZ SPECIALTY INDUSTRIAL PRODUCTS *

TOP SELLER!

- Acidic, etching cleaner designed to remove stains from matured aluminum surfaces such as truck and trailer bodies. It is only suitable for periodic use and should not be used on highly polished surfaces.
- DILUTION: 20:1**

PA5510**	5 Gallons
DR55518*	55 Gallons

**** HAZARDOUS & MUST SHIP FREIGHT ONLY**

SPECIALTY INDUSTRIAL PRODUCTS

SIMONIZ



PRODUCT	PART #	GALLONS	DESCRIPTION	DILUTION
969	PA5515*	5	Heavy Duty Caustic Degreaser. Removes heavy soil from steel, concrete, masonry and similar inert surfaces.	10-64:1
	DR55515*	55		
Concrete Cleaner & Etch	PA5546*	5	Highly concentrated, carefully formulated product removes concrete scale while minimizing corrosive effect on steel. Great for everything from pressure washing concrete mixers and ready mix trucks, to etching concrete car wash floors and sidewalks for painting.	10:1
	DR55546*	55		
True	PA5501	5	Alkaline All Purpose Cleaner. Outstanding liquid that performs well in cold water. Rinses easily.	60:1
	DR55503	55		
Film Fyter	PA5201	5	Non-Butyl, All Purpose Vehicle Cleaner. Heavy duty, noncaustic and concentrated.	60-120:1
	DR55200	55		
Replate	PA5511*	5	Hydrofluoric Acid Liquid Cleaning Compound. Formulated to use on detergent and wax scum buildup on walls, equipment and windows. Cleans and brightens.	3:1
	DR55530*	55		
Strike	PA5280*	5	Alkaline, Caustic Cleaner. Low foam caustic cleaner for operations that require minimum foam.	32-64:1
	DR55285*	55		
Formula 8000	PA5283*	5	Sodium Hydroxide Degreaser. Caustic liquid for heavy soil removal.	60:1
	DR55508*	55		
Restore	PA5528*	5	Hydrofluoric Acid-Based Masonry Cleaner & Restorer. For cleaning heavily soiled surfaces.	3:1
	DR55528*	55		
SWC	PA5550	5	Highly concentrated window cleaner. Fresh fragrance, does not contain ammonia but can be added.	8 oz. per 5 Gallons
	DR55551	55		
Asphalt Release	PA5502	5	Can be used as a lubricant on asphalt slides or asphalt truck beds. It's a perfect choice for use in states or towns where traditional solvents, such as kerosene, are banned from use.	1:6
	DR55502	55		
Solid Gold Cleaner Degreaser	PA5512	5	Versatile cleaner that can de-grease equipment and remove carpet stains. Blends non-ionic surfactants and D-Limonene. Used in multiple applications.	By application - see website!
	DR55512	55		

SPECIALTY INDUSTRIAL POWDER PRODUCTS

SIMONIZ



PRODUCT	PART #	LBS.	DESCRIPTION	DILUTION
Super Power Wash Kit	P01175*	100	Mix 30 pounds powder + 5 Gallons liquid + water = 55 Gallons of product for use. Very cost effective drum kit for touch free automatics. High sudsing, high pH detergent.	20-60:1
SC-100 with D-Limonene	P01165*	100	Heavy-duty non-caustic alkaline parts cleaner. No foam, safe on aluminum.	2-8 oz. per 1 Gallon
B1 Kit	P01150*	100	A low foaming all-purpose butyl cleaner and degreaser. Yields one 55-gallon drum of concentrated cleaner. Heavy-duty degreasing pressure wash.	20-40:1





28" X 44" WINDMASTER SIGNS FOR SIMONIZ® HIGH PROFIT PERFORMANCE CENTER CHEMICALS SIMONIZ



TIRE SHINE
SIMONIZ

\$71.76 **WMS510**



DOUBLE BOND SEALANT
SIMONIZ

\$66.45 **WMS520**



TRIPLE FOAM POLISH
SIMONIZ

\$66.45 **WMS530**



WHEEL BRITE
SIMONIZ

\$66.45 **WMS540**

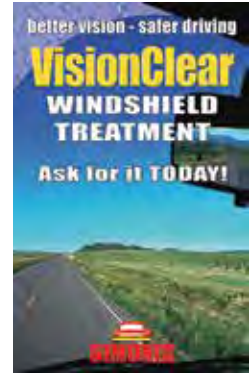

VISION CLEAR
SIMONIZ

\$66.45 **WMS550**



PAD PERFECT TIRE SHINE
SIMONIZ HIGH PERFORMANCE PROFIT CENTER



- For high gloss durable shine. Eliminates labor, lasts longer. Pad Perfect stops hazardous slipping. Perfect tires every time with Pad perfect™ and SIMONIZ Tire Shiner™. Produces a high gloss, long lasting shine your customers will ask for!
- **DILUTION:** RTU

PA5220	5 Gallons
DR30264	30 Gallons
DR55264	55 Gallons



VISION CLEAR™
SIMONIZ HIGH PERFORMANCE PROFIT CENTER



- For protection from rain, snow and sleet. A silicone-containing product that forms a molecular film for windshields and seals the microscopic pores - repels rain, snow and sleet. Causes water droplets to bead up, allowing the windshield to blow the droplets away as you drive. The results: better vision and safer driving.
- **DILUTION:** 50:1

PA5541	5 Gallons	UNSCENTED/UNDYED
DR30500	30 Gallons	DR30547 30 Gallons

HIGH PERFORMANCE PROFIT CENTER SIMONIZ



PRODUCT	PART #	GALLONS	COLOR	DESCRIPTION	DILUTION
DOUBLE BOND SEALANT™	PAS5033	5	-	For vehicle paint protection: The only polymer-fortified protective coating available that can be applied to a vehicle in any type of commercial car wash. SIMONIZ® Double Bond™ contains a unique combination of polymers & reactive silicones to create this breakthrough product. Provides a 30 day level of protection.	75:1
	DRS3033	30	-		
TRIPLE FOAM POLISH WITH UV PROTECTANT	PA5350	5	Blue	For protection from Ultra Violet Rays. Ultra concentrated, visually appealing high foaming conditioner formulated for clear coat finishes. Designed to clean and shine surface by utilizing surface active ingredients and to protect the paint from harmful UV rays. Available in Royal Blue, Violet, Magenta, Sunburst Yellow and Green Chartreuse.	125-150:1
	DR30350	30			
	PA5351	5	Violet		
	DR30351	30			
	PA5352	5	Magenta		
	DR30352	30			
	PA5353	5	Yellow		
	DR30353	30			
PA5354	5	Green			
DR30354	30				
WHEEL BRITE RIM & WHEEL CLEANER	PAS5016*	5	Bright Green	For cleaner "Like New" wheels. A real breakthrough in non-acid wheel cleaning and brightening. Removes brake dust and brightens rims. Produces a bright green foam.	4-17:1
	DR30409*	30			
BLACK ICE HIGH GLOSS TIRE DRESSING	PA5276	5	White	A thixotropic water-based tire dressing that "swells" in the pad, won't drip out and delivers a perfect high gloss shine every time!	Ready to Use
	DR30276	30			
	DR55276	55			



CHEMICALS



SIMONIZ® RX CHEMICALS FOR RECLAIM SYSTEMS

SELF-SERVE



IN-BAY AUTOMATICS



TUNNELS



RX1 PRESOAK & PREP SIMONIZ



- Mildly alkaline cationic surfactant base. Excellent sequestering of hard water, emulsifies road oil quickly through either a prep arch or high-pressure gun
- High pH
- Apply via prep gun or presoak arch
- Penetrates road film
- Rinses away easily
- **PREP GUN DILUTION:** 150-250:1
- **PRESOAK ARCH DILUTION:** 50-150:1

PA5251	5 Gallons
DR30266	30 Gallons
DR55250	55 Gallons



RX5 SEALER SIMONIZ



- Super beading non-MSO
- Bubble gum scented
- Low pH formula
- Rapid water beading
- For use with in-bay automatics or conveyor tunnel washes
- **DILUTION:** 300-600:1

PA5260	5 Gallons
DR30330	30 Gallons
DR55330	55 Gallons

RX CHEMICALS FOR RECLAIM SYSTEMS

SIMONIZ

PRODUCT	PART #	GALLONS	DESCRIPTION	DILUTION
RX2 Wheel & Rim Cleaner	PA5252	5	Unique alkaline wheel & brake dust cleaner. Excellent chelating ability makes this product different than most.	5-10:1
	DR30415	30		
	DR55415	55		
RX3 Lubricating Soap	PA5250	5	Lubricating soap, low pH brush & pad detergent. Excellent lubricity and foam combined with cleaning and free rinsing.	200-400:1
	DR30267	30		
	DR55251	55		
RX4 White Triple Foam	PA5253	5	Low pH white foam cationic polish, works great through compressed air foamers or foam guns. Beads up and rinses freely. Non-fluorescent dyes rapidly break down in pit.	150-300:1
	DR30360	30		
RX4 Red Triple Foam	PA5257	5	Low pH red foam cationic polish, works great through compressed air foamers or foam guns. Beads up and rinses freely. Non-fluorescent dyes rapidly break down in pit.	150-300:1
	DR30361	30		
RX4 Blue Triple Foam	PA5256	5	Low pH blue foam cationic polish, works great through compressed air foamers or foam guns. Beads up and rinses freely. Non-fluorescent dyes rapidly break down in pit.	150-300:1
	DR30362	30		
RX4 Yellow Triple Foam	PA5258	5	Low pH yellow foam cationic polish, works great through compressed air foamers or foam guns. Beads up and rinses freely. Non-fluorescent dyes rapidly break down in pit.	150-300:1
	DR30363	30		
RX6 Drying agent	PA5254	5	Low pH non-MSO drying agent. Disperses water quickly even at the fastest of line speeds.	90-200:1
	DR30335	30		



GREEN SCENE

ECO-FRIENDLY CAR WASH PRODUCTS

• The green movement now has traction and is being mandated everywhere. Use this to promote the environmental correctness of your car wash. Communicate to your customers that you recycle your water, discharge to sanitary sewers, and most importantly that you use Green products approved by the EPA's "Designed For The Environment" program. Always at the cutting edge, SIMONIZ has a complete line of EPA approved products, as well as, merchandising and marketing collateral. Let us show you how to deliver a "Green Clean Car" with a message that will resonate with your existing customer base and will entice new customers... Especially the younger and more environmentally conscious drivers.



PRODUCT	PART #	GALLONS	DESCRIPTION	DILUTION
Presoak & Prep	DRG30205	30	Mildly alkaline surfactant base. Excellent sequestering of hard water, emulsifies road oil quickly through either a prep arch or high-pressure gun	125-175/1 Purple Tip
	DRG55205	55		
Lubricating Soap	PAG5210	5	Lubricating soap, low pH brush and pad detergent. Excellent lubricity and foam combined with cleaning and free-rinsing.	200/300-1 Pink Tip
	DRG30210	30		
	DRG55210	55		
Triple Foam Red	DRG30216	30	Low pH red foam polish, works great through compressed air foamers or foam guns. Beads up and rinses freely. Non-fluorescent dyes rapidly break down in the pit.	200/300-1 Pink Tip
Triple Foam Blue	DRG30217	30	Low pH blue foam polish, works great through compressed air foamers or foam guns. Beads up and rinses freely. Non-fluorescent dyes rapidly break down in the pit.	200/300-1 Pink Tip
Triple Foam Yellow	DRG30218	30	Low pH yellow foam polish, works great through compressed air foamers or foam guns. Beads up and rinses freely. Non-fluorescent dyes rapidly break down in the pit.	200/300-1 Pink Tip
Sealer	PAG5305	5	Super beading non-MSO, low pH sealer, bubble gum scented	200-300/1 Pink Tip
	DRG30305	30		
	DRG55305	55		
Drying Agent	DRG30310	30	Low pH non-MSO drying agent. Disperses water quickly even at the fastest of line speeds.	200/300-1 Pink Tip
	DRG55310	55		
Wheel/Rim Cleaner	PAG5401	5	Unique alkaline wheel and brake dust cleaner. Excellent chelating ability makes this product different than most.	30-50/1 Green Tip
	DRG30401	30		
	DRG55401	55		

CHEMICALS

Trans-Mate™
WE MAKE YOU SHINE

TRANS-MATE™



FILM AWAY

TRANSMATE
IN-BAY FRICTION DETERGENTS



- High pH. Cuts through road film quickly. Free rinsing.
- Used as in-bay detergent and tunnel presoak
- **PRE-SOAK DILUTION:** 50-90:1
- **PREP GUN DILUTION:** 100-200:1

TM5212*	5 Gallons
TM55212*	55 Gallons



BLUE MAX

TRANSMATE TUNNEL BODY SOAPS

- Neutral pH, excellent lubricity for neo-glide type cloth
- **DILUTION:** Up to 350:1

TM5002	5 Gallons
TM55002	55 Gallons



BLUE VELVET

TRANSMATE TUNNEL BODY SOAPS

- Neutral pH, metering-friendly, low viscosity formula
- **DILUTION:** Up to 350:1

TM55001	55 Gallons
----------------	------------



HI-DRY

TRANSMATE IN-BAY & TUNNEL DRYING AGENTS

- Neutral pH, excellent lubricity for neo-glide type cloth
- **DILUTION:** Up to 250:1

TM55030	55 Gallons
----------------	------------

Trans-Mate products are engineered for high-performance and are highly concentrated to deliver low cost per car. You can be assured you are purchasing the highest-quality chemicals that produce superior-looking cars and are always consistent and stable formulations.

Trans-Mate™
WE MAKE YOU SHINE

IN-BAY AND TUNNEL SEALERS/POLISHES

TRANSMATE



FORMULA III



CLEAR COAT



NAME	PART #	GALLONS	DESCRIPTION	DILUTION
Formula III Red	TM5190	5	Triple foam conditioner. Fresh clean fragrance.	Up to 150:1
	TM30190	30		
Formula III Blue	TM5192	5		
	TM30192	30		
Formula III Yellow	TM5194	5	Silicone-fortified, excellent beading and shine, cherry fragrance.	Up to 250:1
	TM30194	30		
Clear Coat Cherry	TM5035	5		
	TM30035	30		
	TM55035	55		

TRANS-MATE™ WHEEL CLEANERS



GREEN MONSTER TRANSMATE WHEEL CLEANERS



- Non-acid foaming wheel cleaner. Green foam wets wheel thoroughly for complete cleaning. Formulated to clean most wheels without brushing. Excellent for customers who cannot use acids or bifluoride based products. Apply with trigger or tank sprayer to cool wheel. Cut through brake dust and grime. Contains no acid or bifluoride.

• **DILUTION:** 3:1

TM55117*	55 Gallons
-----------------	------------



WHISTLE CLEAN TRANSMATE WHEEL CLEANERS



- White wall and wheel cleaner. For wet tires and wheels. Trigger sprayer or treadle applications.
- Concentrated. Effectively removes brake dust and grime from wheels. Excellent for white walls and raised letters.

• **DILUTION:** 1:7 to 24:1

TM5047*	5 Gallons
TM55047*	55 Gallons

TRANS-MATE™ TIRE DRESSINGS



TIRE BRITE TRANSMATE TIRE DRESSINGS

- This solvent silicone tire dressing is best used for automated application systems. Compatible with a variety of application equipment. Applies a high gloss sheen to tires. Chemical is highly concentrated. It has a high-water resistance and great leveling.
- Not recommended for spray-on applications.

• **DILUTION:** Ready To Use

TM30129	30 Gallons
----------------	------------



BLACK MIRROR TRANSMATE TIRE DRESSINGS

- Water-based tire dressing.
- Can be applied by hand or using an automatic application system. When applied provides great leveling and a splendid gloss. Great for use in car washes, used car detailing and retail detailing.

• **DILUTION:** Ready To Use

TM5122	5 Gallons
TM55122	55 Gallons



UNIQUE TRANSMATE TIRE DRESSINGS

- Silicone water based dressing. For exterior applications. Resists water, high gloss. Solvent free, environmentally friendly. Long lasting.

• **DILUTION:** Ready To Use

TM5107	5 Gallons
TM55107	55 Gallons



<https://trans-mate.com/pages/brochures/CarWashProductsCatalog.pdf>

For over 25 years Trans-Mate Products Inc. has been manufacturing and supplying the highest-quality automotive appearance chemicals for the car wash, reconditioning and detailing markets



CALIFORNIA GRAPE FOAM BRUSH DETERGENT

TRANSMATE VIVID SELF-SERVE PRODUCTS

- Removes tough road film build-up. Produces an ultra rich purple foam.
- **SCENT:** Grape
- **COLOR:** Purple
- **DILUTION:** Up to 150:1

TM5140	5 Gallons
---------------	-----------



ASPEN MINT FOAMING PRE-SOAK

TRANSMATE VIVID SELF-SERVE PRODUCTS



- Foams away road film, grime and bugs. No phosphates, acids or solvents. Product may be used in conjunction with any pre-mix or direct feed metering system. Pleasant aspen mint fragrance. Vivid green colored foam.
- **SCENT:** Mint
- **COLOR:** Green
- **DILUTION:** Up to 100:1

TM5144*	5 Gallons
----------------	-----------



CINNAMON STICK FOAMING TIRE & WHEEL CLEANER

TRANSMATE VIVID SELF-SERVE PRODUCTS

- Quickly dissolves brake dust and road grime. Safe on factory wheels. Product may be used in conjunction with any pre-mix or direct feed metering system. Produces a red medium foam. Pleasant cinnamon fragrance.
- **SCENT:** Cinnamon
- **COLOR:** Red
- **DILUTION:** Up to 100:1

TM5146	5 Gallons
---------------	-----------



HAWAIIAN MELON FOAMING HIGH PRESSURE WAX

TRANSMATE VIVID SELF-SERVE PRODUCTS



- Waxing and drying chemical used in professional self-serve car washes. Featuring a rich foaming action and a pleasing melon fragrance, this agent quickly removes water from any vehicle finish
- **SCENT:** Melon
- **COLOR:** Yellow
- **DILUTION:** Up to 300:1

TM5148*	5 Gallons
----------------	-----------

NATIONAL AUTOMOTIVE CHEMICAL



PLUS PRODUCT LINE NATIONAL AUTOMOTIVE CHEMICAL



- 2-in-1 products give your customers more value at your car wash! We combined the benefits of two products into one, just like having toothpaste plus whitener! These new products provide your customers with new benefits for the same old wash cycles!

NAME	PART #	GALLONS	DESCRIPTION	DILUTION	USE
Pre-soak Plus with Tire Cleaner Additive	NAPP1005	5	Attacks road film, brake dust & dirty windows with the added benefit of tire cleaning detergent. Hi foaming, citrus scented.	36-80:1	A,SS,C
	NAPP1055	30			
High Pressure Plus with Glass & Chrome Additive	NAPP2005	5	High foaming detergent that cleans glass and chrome.	75-120:1	A,SS,C
	NAPP2055	30			
Triple Foam Plus with Bug Remover Additive	NAPP4005	5	Foam brush detergent with bug remover additive. Available in scent and color.	80-120:1	SS,C
	NAPP4055	30			
Triple Foam Plus with Bug Remover Additive	NAPP5005B	5	Premium tri-foam with more than just visual appeal. Our unique colored tri-foam helps remove those nasty bugs while still providing that bright color, high shine, and scent to keep those customers rolling in. Available in Blue, Pink and Yellow.	90-120:1	A,SS,C
	NAPP5055B	55			
	NAPP5005P	5			
	NAPP5055P	55			
	NAPP5005Y	5			
Triple Foam Plus Glass Cleaner	NAPP5105B	5	Our unique colored tri-foam helps clean the glass and shine the chrome while still providing that bright color, high shine and scent to keep customers rolling in. Available in Blue, Pink and Yellow.	90-120:1	A,SS,C
	NAPP5155B	55			
	NAPP5105P	5			
	NAPP5155P	55			
	NAPP5105Y	5			
Clear Coat Plus with Drying Agent Additive	NAPP6005	5	Concentrated clear coat sealant with fast dry additive. Formulated with gloss enhancers to provide maximum shine to the car's finish. Clear Coat Plus allows the car to dry faster with less chance of spotting.	75-120:1	A,SS,C
	NAPP6055	55			
Tire Dressing Plus with UV protection Additive	NAPP7005	5	Premium water based dressing with UV protection makes tire look newer longer. This product can be added as an extra profit function generating more money than ever before.	4-8:1	SS, C
	NAPP7055	55			

USAGE KEY

A = Automatic Car Washes SS = Self Serve Car Washes C = Conveyor Car Washes



CERAMIC WAX NATIONAL AUTOMOTIVE CHEMICAL

PRICE	PART #	SIZE
\$168.80	NAC5305	5 Gallons
\$1,699.62	NAD55305	55 Gallons



BANANA HI FOAM: FOAM BRUSH NATIONAL AUTOMOTIVE CHEMICAL

PRICE	PART #	SIZE
\$58.72	NAC5212	5 Gallons
\$441.54	NAD55212	55 Gallons



PRESOAK NATIONAL AUTOMOTIVE CHEMICAL

- The General: Low pH presoak
- Old Glory: High pH presoak

PRICE	PART #	PH	SIZE
\$70.85	NAC5214	Low pH	5 Gallons
\$469.93	NAD55214		55 Gallons
\$65.07	NAC5216	High pH	5 Gallons
\$453.39	NAD55216		55 Gallons

CHEMICALS



NATIONAL AUTOMOTIVE CHEMICAL



TRIPLE FOAM POLISH ULTRA NATIONAL AUTOMOTIVE CHEMICAL



PART #	COLOR	DILUTION
NAC5302R	Red	180-280:1
NAC5302W	White	180-280:1
NAC5302BL	Blue	180-280:1
NAC5302G	Green	180-280:1
NAC5302Y	Yellow	180-280:1
NAC5302PR	Purple	180-280:1
NAC5302A	Amber	180-280:1



TIRE SHINE H2O NATIONAL AUTOMOTIVE CHEMICAL

- Special formulation prevents slip hazards from occurring on wash bay floors from overspray or residue
- No-sling formula is made for use in automatic tire applicators, both brush and sponge type equipment

PART #	SIZE
NAP5405	5 Gallons
NAD30405	30 Gallons
NAD55405	55 Gallons

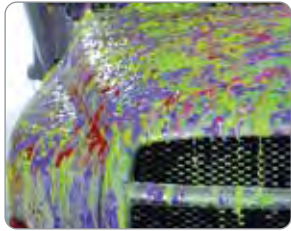

TRIPLE FOAM ULTRA CONDITIONER/CLEANER NATIONAL AUTOMOTIVE CHEMICAL



PART #	COLOR	DILUTION
NAC5205R	Red	180-280:1
NAC5205W	White	180-280:1
NAC5205BL	Blue	180-280:1
NAC5205G	Green	180-280:1
NAC5205Y	Yellow	180-280:1
NAC5205PR	Purple	180-280:1
NAC5205O	Orange	180-280:1
NAC5205A	Amber	180-280:1

POWDERS NATIONAL AUTOMOTIVE CHEMICAL

PRODUCT	PART #	DESCRIPTION	DILUTION
HP Powder	NAP0503	Extra strength; high-pressure soap; 50 lbs makes 55 Gallons	48:1 to 72:1
TC Powder	NAP0504	Caustic tire cleaner; 50 lbs makes 55 Gallons	8-12:1



SELF SERVE ULTRAS NATIONAL AUTOMOTIVE CHEMICAL

PRODUCT	DESCRIPTION	PART #	COLOR	SCENT	DILUTION
Bath Time Ultra	High Pressure Soap	NAC5200	Green	Pine	180-240:1
Soak Me Ultra	Alkaline PreSoak	NAC5201	White	Citrus	200-300:1
Cherry Foam Ultra	Foam Brush Soap	NAC5202	Red	Cherry	600-900:1
Banana Foam Ultra	Foam Brush Soap	NAC5203	Yellow	Banana	200-300:1
Clear Coat Conditioner	Foaming Wax/Paint Sealant/Drying Agent	NAC5300	White	Cinnamon	600-900:1
Tire Time Ultra	Tire/Engine Cleaner	NAC5400	Green	Pine	90-120:1

PREMIUM PRODUCTS FOR AUTOMATIC AND SELF SERVE NATIONAL AUTOMOTIVE CHEMICAL

NAME	PART #	GALLONS	DESCRIPTION	DILUTION
Throttle Dry	NAP5350	5	Throttle dry is a carnauba based spray shine with advanced silicone technology. Lemon scent.	64-90:1
	NAD55350	30		
Shield X	NAP5310	5	A complete body/glass protectant shield repels water without smeary oil buildup. Leaves a mirror-like shine and a lasting "hand waxed" finish. Bubble gum scent.	120-240:1
	NAD30310	30		
D'Lime Hi pH Presoak	NAP5210	5	Designed for use in a two-step presoak application. This presoak produces a rich foam that provides a thorough application to the vehicle surface and gives it time to act on dirt and grime.	48:1 to 80:1
	NAD30210	30		
	NAD55210	55		
Make it Shine Lo pH Presoak	NAP5206	5	Designed to be used in a two-step presoak application that uses both high and low acidity chemicals. High foaming action allows for thorough application of the product.	64:1 to 90:1
	NAD30206	30		
	NAD55206	55		
Bubble Brush	NAP5230	5	Provides pink colored foam with bubble gum fragrance for the self serve foam brush detergent and lubricant for cloth rollovers.	75:1 to 120:1
	NAD30230	30		
	NAD55230	55		



JBS INDUSTRIES® CHEMICALS



SELF-SERVE POWER CONCENTRATE

PRODUCT	PART #	COLOR	SCENT	GALLONS	DESCRIPTION	DILUTION
Fonic Wash PC	JBCFW	Red	Fresh	5	Tremendous foaming HIGH PRESSURE DETERGENT. Unique surfactant blend provides copious amounts of foam, lubricity and cleaning action.	90:1
New!	JBCFW-BG	Dark Red	Bubble Gum			240-360:1
JB-55 Foaming Brush PC	JBCFB	Pink	Strawberry	5	Extremely concentrated FOAMING BRUSH DETERGENT. Product provides excellent foaming, lubricity and cleaning action.	240-300:1
	JBCFBBG	Blue	Bubble Gum			
	JBCFBW	Clean White	Cherry			
	JBCFB-OR	Orange	Orange Island Punch			
New! Lava Foam	JB5255	Purple	Grape Taffy	5	This product is a premium detergent designed to lift contaminants and rinsing freely. Designed for tunnel lava arches and self-serves.	120/1
New! Pre-Soak PC	JB5215	Yellow	Lemon Drop	5	This quick-acting alkaline PRE-SOAK removes road film, grease, grime, and oils from car surfaces. It's effective in both hot and cold water applications, and it can be used effectively in virtually any car wash application.	90-120:1
Film Buster PC	JBCPS	Purple	Lemon	5	High foaming SELF-SERVE PRESOAK which removes road film, grease, grime and oil from vehicle's surface. Effective in both hot or cold water applications. Rinses quickly and dries streak free. Extremely concentrated.	90-120:1
Mighty White PC	JBCMW	Amber	Lemon	5	Customer appealing, emerald green SELF-SERVE TIRE & ENGINE CLEANER. Extremely high foaming with fresh lemon scent! Cuts brake dust, grease and grime. 100% biodegradable.	90-120:1
HB Rinse Aid PC	JBCRA	Red	Cherry	5	Extremely concentrated self-serve super-beading SPRAY SHINE & RINSE AGENT. Designed for high and low pressure applications in all types of washes. Quickly causes water to bead and "dance" off the vehicle's surface. Doubles as a drying agent for automatics and tunnels.	450-600:1
Storm PC	JBCST*	Purple	Lavender	5	Fast-acting SELF-SERVE PRESOAK. The incredible cleaning action & foaming of this remarkable presoak will amaze customers! Removes road film, grease, grime and oil from vehicle's surface. Effective in both hot and cold water applications. Rinses quickly and dries streak free.	90-120:1
Predator PC	JBCPR*	Amber	Lemon	5	Fast-acting SELF-SERVE TIRE & ENGINE CLEANER. Extreme cleaning action cuts brake dust, grease and grime. Safe for all types of tires and rims (both foreign and domestic). 100% biodegradable.	90-120:1

* HAZARDOUS MATERIAL

SPECIALTY CAR WASH PRODUCTS

PRODUCT	PART #	GALLONS	DESCRIPTION	DILUTION
New! Super Detergent	JB5252	5	A high-foaming SUPER DETERGENT. It provides excellent foam, great lubricity, and smells like fruity island punch!	90:1
New! Super Protectant	JB5351	5	This premium SUPER PROTECTANT contains Carnauba wax and silicone enhancers to gloss and protect the clear coat finishes on all vehicles. Island punch scented.	120:1
HYB Shine	JB5325	5	HYDROCARBON FREE SPRAY SHINE & DRYING AGENT. Specially designed for reclaim systems. Quickly causes water to sheet off the vehicle surface & adds extra shine to clear coat finish.	90-120:1
	JB30325	30		
	JB55325	55		
Bay & Wall Cleaner	JB5502*	5	NEW BAY & WALL CLEANER quickly removes build-up from brick block and fiberglass walls. Excellent cleaner for interiors of self-serve car wash walls. Contains phosphoric acid and ABF. Keep away from glass. Always wear gloves and safety goggles when using product.	10:1
Bugsaw	JB5501	5	Fast-acting CITRUS BUG REMOVER quickly penetrates and liquefies bugs and other insects that are normally encountered on windshields and grills. Product rinses easily and freely. Safe for all painted surfaces.	5-20:1

* HAZARDOUS MATERIAL

JBS INDUSTRIES® CHEMICALS



AUTOMATIC CAR WASH PRODUCTS

JBS INDUSTRIES



PRODUCT	PART #	GALLONS	DESCRIPTION	DILUTION
PREDATOR®	JB5404*	5	A very concentrated exotic POLYMER TIRE & WHEEL CLEANER. Spray on and rinse off. Quickly removes stubborn grease stains and brake dust. May be used in CTA applications or manually applied. Contains no acids. Purple color.	8-24:1
	JB30404*	30		
	JB55404*	55		
Red Storm®	JB5205*	5	Extremely fast acting High PH Presoak, specifically designed for touch-free automatic applications. Formulated for the most extreme cleaning conditions. Quickly removes grease, grime and road film from vehicle surface. Tremendous high foaming action. Blue Color. Lemon Scent.	75-120:1
	JB30205*	30		
	JB55205*	55		
Stingray Plus Low pH®	JB5231	5	Premium Acid Replacement Technology Low pH Pre-Soak and touch-free two-step detergent. Patented Technology. Designed as the first step in a two-step process. Especially effective on glass and rims. Removes grime, road film, oxide films and brake dust from vehicle's surface. Designed specifically for automatic and tunnel two-step applications. Non-corrosive.	75-120:1
	JB30231	30		
	JB55231	55		
Fonic Wash®	JB5201	5	The ultimate foaming detergent, designed for self service high pressure & full service foaming arch systems. Product is a unique blend of surfactants which provides great foaming, lubricity and cleaning action.	90-240:1
	JB30201	30		
	JB55201	55		
Ceramic Finish Clear Coat	JB5320	5	Offers protection from UV ray damage and oxidation. Durable formula lasts up to 30 days. Prevents etching and staining - makes vehicle cleaning easier. Increases gloss and shine.	300:1
Ceramic Finish HP Clear Coat	JB5321	5	High-pressure clear coat. Offers protection from UV ray damage and oxidation. Durable formula lasts up to 30 days. Prevents etching and staining - makes vehicle cleaning easier. Increases gloss and shine. Can be used with in self-serve, tunnel arch or in-bay automatic where foam application is desirable.	Self Serve: 240:1 Automatic: 300:1
Action Dry Drying Agent	JB5303	5	The ultimate drying agent. This product creates quick breaking action which dramatically reduces drying time. Extremely concentrated! Provides additional protection to clear coat. Designed for automatic or tunnel applications.	120-240:1
	JB30303	30		
	JB55303	55		
Ceramic Finish HP Ceramic Shine	JB5323	5	Specially formulated for self-serve applications. Apply through self-serve wand.	90-120:1
Ceramic Finish Clear Coat Protectant	JB5324	5	Revolutionary car wash chemistry that produces a hand wax quality shine and superior paint protection.	240:1



JBS INDUSTRIES® CERAMIC FINISH SIGNAGE

WMS228	28" X 44" Windmaster Sign
WMS225	28" X 44" Windmaster Sign
SI0225	23" X 16" Full Color Laminate Bay Sign
BANNER228	3' X 6' Full Color Vertical Banner
BANNER225	3' X 6' Full Color Vertical Banner
SI0227	Ceramic Shine Signage Bay Sign
CB04650	Ceramic Shine Rotary Decal
DCR228	Ceramic Finish Drum Cover 55 Gal.

JBS INDUSTRIES® CHEMICALS



THE AMAZING GLOW FOAM®

PRODUCT	PART #	GALLONS	COLOR	SCENT	DESCRIPTION	DILUTION
Glow Foam Detergent Power Concentrate	JBCGFDETB	5	Blue	Cherry	The most unique Tri-Foam Brush Detergent on the market today! Glow Foam Detergent PC provides brilliant colored foam (hot pink, vibrant canary yellow & electric blue) with added foaming and lubricity capabilities for tremendous customer appeal! Also compatible with tri-foam self serve conditioner systems. Non-staining formula.	240-300:1
	JBCGFDETP	5	Pink	Cherry		
	JBCGFDETY	5	Yellow	Cherry		
Glow Foam Polish	JB5381	5	Blue	Cherry	The most unique tri-foam "gloss enhancer" polish on the market today! Glow Foam Polish provides brilliant colored foam (hot pink, canary yellow & electric blue) with special gloss enhancing agents (silicone carnauba) to protect the vehicle's surface. Wild cherry scent. Non-staining dyes. Excellent for full-serve and automatic tri-foam polish application, as well as self-serve tri-foam conditioner systems! The true standard of the industry.	90-120:1
	JB30381	30				
	JB55381	55				
	JB5380	5	Pink	Cherry		
	JB30380	30				
	JB55380	55				
	JB5382	5	Yellow	Cherry		
JB30382	30					
JB55382	55					
Glow Foam Polish Power Concentrate	JBCGF5B	5	Blue	Cherry	The most unique gloss enhancing Tri-Foam Polish on the market today! Glow Foam Polish PC provides brilliant colored foam with special gloss enhancing agents (silicone carnauba) to protect the vehicle's surface. Extremely concentrated.	240-480:1
	JBCGF5P	5	Pink	Cherry		
	JBCGF5Y	5	Yellow	Cherry		
Winter Glow Foam	JBWGF5B*	5	Blue	Cherry	Unique winter tri-foam "gloss enhancing" polish. Winter Glow Foam Polish provides brilliant colored foam to help clean and protect the vehicle's surface. Non-staining formula. Effective up to -50 F.	Per Chart
	JBWGF5P*	5	Pink	Cherry		
	JBWGF5Y*	5	Yellow	Cherry		
Ceramic Finish Glow Foam	JB5322-B	5	Blue	None	Ceramic Finish is applied during a tunnel wash service package. Provides a ceramic finish similar to hand waxing. Using all three colors produces a layering effect that delivers a shinier and dryer car upon application.	1:120
	JB5322-P	5	Pink	None		
	JB5322-Y	5	Yellow	None		



* HAZARDOUS MATERIAL



ISLAND PUNCH

PRODUCT	PART #	GALLONS	COLOR	SCENT	DESCRIPTION	DILUTION
Glow Foam Polish	JB5350-B	5	Blue	Island Punch	Leave your customers' cars looking like new with this delightfully scented, island punch polish formula from JBS! Bright blue Glow Foam Polish applies perfectly in your self-serve, friction automatic, or touchless automatic bays. It is formulated with silicone and carnauba to deliver a beautiful gloss	240-360:1
	JB5350-Y	5	Yellow			
	JB5350-P	5	Pink			



HAZARDOUS MATERIAL. A FEE MAY BE ADDED TO YOUR ORDER.



1-800-233-3873 • (717) 684-6721 • FAX (800) 446-0495 • KLEENRITE.COM

SHORE CORPORATION CHEMICALS



SHORE 700 HI SHINE RINSE AID SHORE CORPORATION

- A unique rinse aid built for the de-sudsing of soaps and polishes before going into drying agent. Helps reduce spotting.
- **DILUTION:** 240:1

CC0700-05	5 Gallons
CC0700-30	30 Gallons
CC0700-55	55 Gallons



SHORE 901 FLASH DRY PLUS SHORE CORPORATION

- High performance drying agent with UV Protectant. Aids in repelling water off windshields during wet weather driving.
- **DILUTION:** 300:1

CC0901-05	5 Gallons
CC0901-30	30 Gallons
CC0901-55	55 Gallons



SHORE 211 SIGNATURE CLEAN SHORE CORPORATION

- Low pH and HF-free liquid presoak with fast action cleaning and rinsing.
- **DILUTION:** 120:1

CC0211-05	5 Gallons
CC0211-30	30 Gallons
CC0211-55	55 Gallons



SHORE 950 CARNAUBA WAX SHORE CORPORATION

- Golden carnauba wax to be used in Tsunami™ or waterfall type foam applicators. Pleasant Piña Colada fragrance.
- **DILUTION:** 65:1

CC0950-05	5 Gallons
CC0950-30	30 Gallons

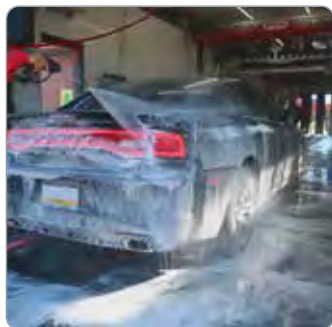

SHORE 620 BUG & TIRE PLUS SHORE CORPORATION

- **DILUTION:** Varies per application - see SDS sheet at kleenrite.com

CC0620-05	5 Gallons
CC0620-30	30 Gallons
CC0620-55	55 Gallons



SHORE 980 REPEL SHORE CORPORATION

- High performance rain and dirt repellent. A nonstick clearcoat that provides increased visibility on glass and prevents soil re-deposition on automotive surfaces.
- **DILUTION RATES:**
Range from 150-300:1

CC0980-05	5 Gallons
CC0980-55	55 Gallons



Contact us with your questions and ideas
800-860-4978/shorecorpsales@shorecorporation.com

From over four decades of experience, comes a line of products dedicated to the innovation you are looking for. Whatever the project, ShoreBest has what you need to get the job done right the first time.

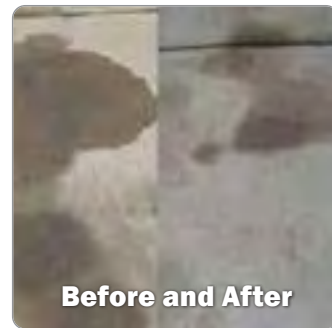

Before and After

BUGS (BIO ULTIMATE GREASE SCAVENGER) SHORE CORPORATION

- Removes greasy, oily buildup with a biodegradable formula. Unique formula consists of bacteria spores, biodegradable surfactants and other bio-stimulating agents that attack oils and petroleum products with ease.
- **DILUTION:** 0-4:1

SB2351-05	5 Gallons
------------------	-----------



Before and After

CON-D-SOIL NON-ACIDIC CLEANER SHORE CORPORATION

- Removes oil stains, grease, rubber heel marks, oxidation stains and light to moderate soiling
- A highly effective non-acidic cleaner for all concrete and many masonry surfaces
- **DILUTION:** Varies per application - see SDS sheet at kleenrite.com

SB2790-05	5 Gallons
------------------	-----------



SHORE CORPORATION CHEMICALS



SHORE CORPORATION PRODUCT LINE

- This product line is designed to produce the same quality shine at high chain speeds
- The Shore Corporation will improve productivity by reducing prep time, drying time and staffing
- The current chemistry is a result of 30 years of experimenting, testing and improving the formula
- Developed to be environmentally safe while remaining an effective cleaning agent



CALL FOR PRICE ON ALL PRODUCTS

APPLICATION	PRODUCT	PART #	SIZE	DESCRIPTION	DILUTION
Tunnel, In-Bay, Self-Serve	Shore 680 Bug Spray	CC0680-05	5 Gallon	Low pressure hand alkaline pre-prep for bugs and backends.	25:1
		CC0680-30	30 Gallon		
		CC0680-55	55 Gallon		
Tunnel, In-Bay	Shore 620 Prep & Body Spray	CC0620-05	5 Gallon	Two applications. (1) high pressure alkaline prep gun soap, or (2) alkaline cleaner in tunnel, foams and rinses well too.	Prep Gun 900-1, tunnel presoak or foam cleaner 120-1
		CC620-30	30 Gallon		
		CC620-55	55 Gallon		
Tunnel, In-Bay, Self-Serve	Shore 520 High pH Prep	CC0520-05	5 Gallon	Alkaline wheel cleaner applied through 1st CTA. Can also be used as a bug remover.	25:1
		CC0520-30	30 Gallon		
		CC0520-55	55 Gallon		
Tunnel, In-Bay	Shore 211 Signature Clean	CC0211-05	5 Gallon	Low pH and HF-free liquid presoak with fast action cleaning and rinsing.	120:1
		CC0211-30	30 Gallon		
		CC0211-55	55 Gallon		
Tunnel, In-Bay	Shore Tunnel Mint	CC3000-05	5 Gallon	An eco-friendly product injected into soap application or atomized in the tunnel. Superior mint fragrance strength.	240:1
		CC3000-30	30 Gallon		
		CC3000-55	55 Gallon		
Tunnel, In-Bay	Shore 160 Wrap & Mitter Soap	CC0160-05	5 Gallon	High foaming lubricity for mitters and wraps. Mild low pH provides quick rinsing and limits spotting.	240:1
		CC0160-30	30 Gallon		
		CC0160-55	55 Gallon		
Tunnel, In-Bay, Self-Serve	Shore 830 Red Shine Polish with Cherry Fragrance	CC0830-05	5 Gallon	Fast rinsing Clearcoat polishes, work in conjunction with superior silicones of Shore 901 Drying Agent.	240:1
		CC0830-30	30 Gallon		
	Shore 832 Blue Shine Polish	CC0832-05	5 Gallon		
		CC0832-30	30 Gallon		
	Shore 834 Yellow Shine Polish	CC0834-05	5 Gallon		
CC0834-30	30 Gallon				
Tunnel	Shore 480 Low pH Wheel Cleaner	CC0480-05	5 Gallon	2nd step of wheel cleaning process after 520. Cleans and brightens. Outstanding non-HF alternative.	25:1
		CC0480-30	30 Gallon		
		CC0480-55	55 Gallon		
Tunnel, In-Bay	Shore 700 Hi Shine	CC0700-05	5 Gallon	A unique rinse aid built for the de-sudsing of soaps and polishes before going into drying agent. Helps reduce spotting.	240:1
		CC0700-30	30 Gallon		
		CC0700-55	55 Gallon		
Tunnel, In-Bay, Self-Serve	Shore 990 CeramicLustre®	CC0990-05	5 Gallon	This high-performance ceramic coating repels water and exhibits anti-soil properties. Please call a Kleen-Rite representative to discuss dilution ratios.	Ranges from 100:1 to 512:1
		CC0990-30	30 Gallon		
		CC0990-55	55 Gallon		
Tunnel, In-Bay, Self-Serve	Shore 950 Carnauba Wax	CC0950-05	5 Gallon	Golden Carnauba wax to be used in Tsunami™ or waterfall type foam applicators. Pleasant Piña Colada fragrance.	65:1
		CC0950-30	30 Gallon		
Tunnel, In-Bay, Self-Serve	Shore 920 Cherry Clearcoat	CC0920-05	5 Gallon	A superior Clearcoat and sealer developed with new technologies which will produce a brilliant shine and protection. Works well as drying aid.	300:1
		CC0920-30	30 Gallon		
		CC0920-55	55 Gallon		
Tunnel, In-Bay, Self-Serve	Shore 901 Flash Dry Plus	CC0901-05	5 Gallon	High performance drying agent with UV Protectant. Aids in repelling water off windshields during wet weather driving.	240:1
		CC0901-30	30 Gallon		
		CC0901-55	55 Gallon		
Tunnel, In-Bay, Self-Serve	Shore 980 Repel	CC0980-05	5 Gallon	A high performance rain and dirt repellent. A nonstick clearcoat that provides increased visibility on glass and prevents soil re-deposition on automotive surfaces.	Ranges from 150 to 300 : 1 with water
		CC0980-55	55 Gallon		
Tunnel, In-Bay, Detail	Shore 1010 Tire Shine	CC1010-05	5 Gallon	Brilliant, long lasting satin shine. Can be used in online tunnel tire shine machines or applied by hand. Solvent-based. VOC and OTC compliant for all states.	Application amounts vary with online machines
		CC1010-30	30 Gallon		
		CC1010-55	55 Gallon		
Tunnel, In-Bay, Detail	Shore 1020 Tire Shine	CC1020-05	5 Gallon	Brilliant, long lasting gloss shine. Can be used in online tunnel tire shine machines or applied by hand. Water-based.	Application amounts vary with online machines
		CC1020-30	30 Gallon		
		CC1020-55	55 Gallon		
ALTERNATIVES & CONCENTRATES					
Tunnel, In-Bay, Self-Serve	Shore 640 Prep & Body Extreme Concentrate	CC0640-05	5 Gallon	Alkaline prep and body soap. Concentrated version of Shore 620	200:1
		CC0640-30	30 Gallon		
Tunnel, In-Bay, Self-Serve	Shore 560 Wheel & Tire Extreme Concentrate	CC0560-05	5 Gallon	Alkaline Tire and wheel cleaner. Concentrated version of Shore 530	50:1
Tunnel, In-Bay, Self-Serve	Shore 212 Premium Clean	CC0212-05	5 Gallon	Low pH and HF-free liquid presoak Concentrated version of Shore 211	240:1
		CC0212-30	30 Gallon		

MAINTENANCE CHEMICALS

SHORE CORPORATION MAINTENANCE CHEMICALS

SHORE CORPORATION

OTHER SIZES AVAILABLE

* HAZARDOUS MATERIAL

NAME	PART #	GAL.	USE	DETAILS	DILUTION
Con-D Soil Non-Acidic Cleaner	SB2790-05 *	5	Concrete & Masonry	Removes oil stains, grease, rubber heel marks, oxidation stains and light-moderate soiling from concrete, tile, grout	Varies Per Application See SDS sheet
EIFS Scrub Non-Acidic Cleaner	SB2600-05 *	5	EIFS Surfaces & Painted Trim	Safe on EIFS exteriors, stucco, concrete, paint, vinyl siding, aluminum siding, fascia, soffit, gutters & downspouts	1:4
BUGS (Bio Ultimate Grease Scavenger)	SB2351-05	5	Eco-Friendly Surfactant	Removes greasy, oily buildup with a biodegradable formula. Attacks oils and petroleum products with ease	0-4:1
Odor Destroyer Surface Cleaner	SB2812-05	5	Odor Neutralizer	Eliminates odors from organic decay, smoke, fire sewage, mildew & more!	Use undiluted in most applications
ShoreWalls Wall Cleaner & Rust Remover	SCA762-05 *	5	Wall Cleaner	Cleans walls without abrasive action	-
FreshFlow	SCB119	-	Water Freshener	Dissolvable block designed to remove microorganisms to help control odors in your water recovery system. Sold in case of (2) 10-pound blocks.	-

KLEAN TUNNEL

AP FORMULATORS



Klean Tunnel is a fast acting, lower acidic car wash cleaner. Its powerful formula quickly removes buildup or dirt and grime without the scrubbing. Klean Tunnel is safe and effective on most surfaces including fiberglass, FRP, metal, vinyl, painted block, and most types of brick while the lower acid level provides a safer solution for the user.

- Potent clinging properties work longer on heavy buildup of dirt and grime
- Fast acting formula
- Provide a visually appealing atmosphere
- Simply spray on and pressure wash clean
- No need for excessive scrubbing
- Safe on most surfaces



\$74.23	KT100-5	5 Gallons
\$675.00	KT100-55	55 Gallons

BREAK DOWN

AP FORMULATORS



Break Down is a premium, professional grade, water-based bug remover. Its fast acting formula dissolves and softens even the toughest bug residue. The potent clinging properties allow for longer dwelling on heavy buildup, reducing the need for excessive scrubbing. Break Down is quick, easy to use and safe on all painted surfaces.

- Water-based bug remover
- Fast acting formula
- Dissolves and softens bug residue
- Longer dwelling for heavy buildup
- Reduced need for excessive scrubbing
- Safe on all painted surfaces
- Easy to use



\$69.22	BD085-5	5 Gallons
\$675.37	BD085-55	55 Gallons

KLEAN WALL

AP FORMULATORS



- Spray On. Rinse Off. Increase Profits. Our Klean Wall cleaner has made the once dreaded task of cleaning walls a simple and easy job. Just spray Klean Wall on and rinse off.
- Call today for your FREE 16 oz sample!

\$76.63	KW5	5 Gallons
\$667.53	KW55	55 Gallons

**!! POISONOUS !!
MUST SHIP FREIGHT**



KLEAN WALL II

AP FORMULATORS



- 100% HF-free
- No scrubbing required
- SDS and label have NO poison restrictions
- Made in the U.S.A.



\$76.63	KW5-2	
----------------	--------------	--

BRICK RENEW

AP FORMULATORS



- Scientifically formulated to clean natural brick and stone walls without scrubbing. Simply spray Brick Renew on the wall and rinse off with a high pressure water stream. Loosens and removes scale, soap scum, and oxidation.
- Call today for your FREE 16 oz sample!

\$76.63	APF5525
----------------	----------------



IT WORKS

NATIONAL AUTOMOTIVE CHEMIC



- Powerful liquid detergent which economically removes dirt and stains from fiberglass, brick and block walls. HF Free Product
- Designed for cleaning plastic wall panels.
- Spray on with low pressure/spray off with high pressure



NAME	PART #	GAL.	DIL.
Wall Cleaner	NAD5500 *	5	1-3:1
	NAD30500 *	30	
It Works Plastic Wall Cleaner	NAP5408	5	1-20:1

* HAZARDOUS MATERIAL

MAINTENANCE CHEMICALS



KEM FRESH DEODERANT

SIMONIZ



- Does not affect cleaning power
- Add to cleaning solutions for fresh scent
- Super-concentrated formula
- Available in two fragrances
- **DILUTION:** 50-75:1

PART #	GALLONS	FRAGRANCE
PA5542-C	5	Cherry
PA5542-L	5	Lemon



RESTORZIT

SIMONIZ



- A heavy-duty acid based cleaner formulated for use on detergent and wax scum buildup on walls, equipment and windows. It will clean and brighten most of these surfaces. Replenishes by cutting through detergent/wax scum and buildup, restoring and giving it that "like new" look!
- **DILUTION:** 2-10:1 or 2-3:1

PA5590	5 Gallons
DR30590	30 Gallons
DR55590	55 Gallons

PREMIUM PRODUCTS FOR AUTOMATIC AND SELF SERVE

PRODUCT	PART #	GAL.	DESCRIPTION	DILUTION
Pit Deodorizer	NAP5406	5	Remove the odor in both self serve pits and reclaim systems. Give your customers a positive experience when performing pit maintenance and reclaim systems. Cinnamon scented.	240-500:1
	NAD55406	55		
Pit Enzyme	APF5520	5	Used in reclaim systems as an odor/oil remover. Enzymes eat oil/odor causing bacteria.	Use 6 oz. per day for 1 month, then 6 oz. per week

CLEANUP/SPILL KITS & MORE



OIL-DRI MONTMORILLONITE CLAY ABSORBENT MATERIAL

SPILL KITS

- 40 quart bag; weighs approximately 46 lbs.
- Montmorillonite clay granules absorb approximately 4.2 Gallons of liquid
- Toss on spills or leaks, let it soak up fluid, then sweep/scoop up the saturated granules
- Great for use in detailing shops, car washes, or garages

\$22.26 SKBU050

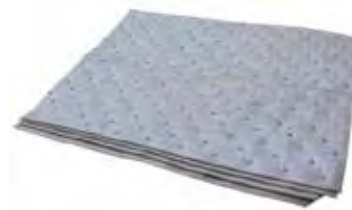

SORBENT PADS

SPILL KITS

- 15" x 19"
- Double weight, gray
- 27 gal. sorbent capacity
- 100/case

\$126.50 SKBU02



UNIVERSAL SPILL KIT

SPILL KITS

- Universal Spill Kit in a clear poly bag with zipper for easy storage - has a 5 gallon capacity
- It soaks up oils, water, coolants, solvents and water-based fluid

INCLUDES THE FOLLOWING:

- 10 Pads (15" x 19")
- 2 Disposal Bags w/ Ties
- 3 Sorbent socks (3" x 4")
- 1 pair of nitrile gloves

\$53.35 SKBU



SORBENT SOCK

SPILL KITS

- 3" x 48"
- 30 gallon capacity per sock
- 30 per case
- Absorb acids, bases, oil & water

\$104.25 SKBU01



SPILL CONTAINMENT PLATFORM

SPILL KITS

- High-density polyethylene (HDPE) construction
- The grated top is removable for easy cleaning, and the platform connects easily to other platforms through a built-in U channel.
- Removable grated top
- Excellent chemical resistance and durability

PRICE	PART #	SPILL CAPACITY	SPILL LOAD WGT. CAPACITY	DIMENSIONS	HOLDS
\$178.76	SKBU115	30 Gallons	5000 lbs	51 1/2" X 26 1/4" X 6 1/2"	2 Drums
\$434.37	SKBU116	60 1/2 Gallons	10000 lbs	52 1/2" X 51 1/2" X 6 1/2"	4 Drums

CALIFORNIA PROPOSITION 65 NOTE: some items on this page may fall under the Proposition 65 act. Please consult the State of California Proposition 65 list (oehha.ca.gov/proposition-65/proposition-65-list) to learn more and to see a comprehensive list of Proposition 65 chemicals.

HAZARDOUS MATERIAL.
A FEE MAY BE ADDED TO YOUR ORDER.



1-800-233-3873 • (717) 684-6721 • FAX (800) 446-0495 • KLEENRITE.COM

715

CLEANUP/SPILL KITS & MORE

ULTRA-UTILITY SPILL TRAYS

SPILL KITS



- Heavy-duty polyethylene construction with UV inhibitors
- Rust and corrosion resistant
- Can be placed under vehicles to catch fluids and lubricants from engines, hydraulics, etc.
- Trays nest inside each other for convenient storage when not in use
- Ribbed bottom keeps buckets, cans, and other containers slightly elevated above spilled fluids
- Protected by the industry's strongest warranty - 5 years against any material or workmanship defects under normal use and conditions.
- Made in the U.S.A.

PRICE	PART #	CAPACITY	DIMENSIONS	PRICE	PART #	CAPACITY	DIMENSIONS
CALL	SKBU100	12 Gallon	12" x 48" x 4 3/4"	CALL	SKBU102	24 Gallon	24" x 48" x 4 3/4"
\$94.21	SKBU106	18 Gallon	24" x 36" x 4 3/4"	CALL	SKBU104	30 Gallon	30" x 48" x 4 3/4"

5 GALLON PLASTIC BUCKET WITH METAL HANDLE

BUCKETS & ACCESSORIES



- Ideal for paints, soaps, water, detergent, cleaning chemicals
- Metal handle with plastic grip for comfortable transport of heavy contents
- 100% prime virgin HDPE
- Heavy duty 90mil wall thickness
- Withstand temperatures up to 180°F
- Includes child warning label printed in black
- FDA approved and proudly made in the USA

\$6.25 BKT05R

RED PLASTIC LID WITH POUR SPOUT & SEALING GASKET

BUCKETS & ACCESSORIES



SPOUT

- For use with BKT05R buckets
- 100% Prime virgin HDPE
- Tamper resistant with tear tab security feature
- Highly durable
- Proudly made in the USA
- Withstand temperatures up to 180°F
- FDA approved

\$2.20 BKT05R-SLID

CONTROL UNIT

SUPPLIES & ACCESSORIES



- Circuit board operates off of 24VAC after incoming 120V passes through a 20VAC step down transformer
- Relay is triggered by 24VAC from board, which is tied into probe unit switching the 120V incoming power to the pump
- Detergent concentrate setting lower right
 - Setting with a good powder detergent between 0-55
- Unit has on/off switch to activate board
 - Power and pump light indicators on top of case
- 2 red lugs on terminal are C & H pump lines

\$315.07 CH1030 110 Volt **\$32.94** CH1045 Probe Only

DWYER FLOWMETER

DWYER



NOT FOR EXPORT

- Designed to regulate or register flow rate of liquid product.
- Acrylic plastic body.
- Maximum pressure up to 100 PSI.
- Metal mounting inserts tapped with 10/32" thread.
- Maximum temperatures up to 120°F.

ADJUSTABLE			NON-ADJUSTABLE		
\$67.00	VL0605-SSV	.6-5 GPH	\$46.25	VL0210-SS	2-10 GPH
\$59.66	VL0210-SSV	2-10 GPH	\$46.27	VL0605-EC	.6-5 GPH
\$67.00	VL0320-SSV	3-20 GPH			

PANEL MOUNT FLOWMETER

BLUE-WHITE INDUSTRIES, LTD.



- For accurate control of liquids or air. Great for soap or wax lines and RO systems. Constructed of solid acrylic meter bodies with stainless steel internals and printed scales. Can be mounted direct or panel mounted. Choice of adjustable or non-adjustable.
- Maximum temperatures up to 110°F.
- Maximum pressure up to 120 PSI.
- 1/2" MPT • .5 - 5.0 GPM

\$117.34 BWF55500L Non-Adjustable
\$153.30 BWF55500LA Adjustable

TEST KITS



EC/TDS DIGITAL HYDROTESTER HM DIGITAL

- Measures electrical conductivity (EC), total dissolved solids (TDS). Perfect for testing RO systems
- Four scales: EC: μS , mS; TDS: ppm, ppt
- Automatic Temperature Compensation (ATC)
- Measurement Range: 0-9990 μS ; 0-5000 ppm; 0-9.9 mS; 0-5.0 ppt
- Digital Calibration (push button) to any point within the tester's range
- Auto-off function, data-hold function and low-battery indicator
- Display: large and easy-to-read LCD screen includes simultaneous temperature reading
- Includes a protective cap and batteries

\$49.42

HMO080



WATERPROOF EC/TDS/TEMP METER HM DIGITAL

- Measures electrical conductivity (EC), total dissolved solids (TDS), salinity and temperature
- UPGRADED: Four scales: μS , mS, ppm, ppt
- Three different non-linear EC-to-TDS conversion factors (KCl, 442TM, NaCl)
- Automatic Temperature Compensation (ATC) using three temperature coefficients
- Measurement Range: 0-9990 μS ; 0-8560 ppm; 0-9.99 mS; 0-8.56 ppt
- Digital Calibration (push button) to any point within the meter's range
- Auto-off function, data-hold function and low-battery indicator

\$86.32

HM0100

HACH TEST KITS

- Testing kits for water hardness, nitrates, nitrites, alkalinity and pH analysis. Designed for quick checks on the quality of water supplies or the efficiency of water softeners, spot free systems, etc.



LOW RANGE TDS TESTER HACH TEST KITS

- Easy calibration steps take the guesswork out of calibrating the sensor to keep it in optimum condition.
- Easy to replace AAA batteries and convenient sample cup make maintenance and measurement simple.
- The large LCD screen is easy to read; backlighting is included on Pocket Pro models, allowing measurement in almost any lighting environment.
- Intended for professional use only.

\$252.87

TK9531200



PH TEST KIT HACH TEST KITS

- With pH measurement paper strips for analysis
- 0 - 14 pH Range, 100/pk
- Designed for quick checks on the quality of water supplies or the efficiency of water softeners, spot-free systems, etc.

\$51.47

TK26013



HARDNESS TEST KIT HACH TEST KITS

- With hardness measurement paper strips for analysis
- 0-425 PPM
- Easy to use, disposable, and inexpensive
- A great way to obtain quick, quantitative answers in the field or in the lab

\$29.35

TK274525



TOTAL WATER HARDNESS TEST KIT HACH TEST KITS

- Hardness test kit with a liquid drop count titration method of analysis.
- Measures hardness as CaCO_3 (1 μg = 17.1 mg/L)

\$44.06

TK5B



TITRATION TESTING KIT FOR SELECT KLEEN-RITE CHEMICALS TEST KITS

- This titration kit allows you to test a diluted Kleen-Rite product to determine the dilution level. Includes chemicals, graduated cylinder, beaker, and instructions in a convenient carrying case.

CONTENTS:

- Graduated Cylinder
- Testing Instructions
- Phenolphthalein Indicator (in a dropper bottle)
- 1.0 Normal Sulfuric Acid (in a dropper bottle)

USE FOR THESE KLEEN-RITE CHEMICALS:

- In-Bay Presoak
- High pH Extreme
- Beaker
- Storage Box
- All-Polymer System

\$27.14

KRTTK



JBS TITRATION KIT

JBSTK



SIMONIZ® 1 STEP - LOW-pH SOAPS

CH1055

TITRATION KITS

PRICE	PART #	KIT
\$15.60	CH1055	SIMONIZ® Step 1 (Low pH Soaps)
\$20.78	CH1050	SIMONIZ® Step 2 (Hi pH Soaps)
\$61.04	JBSTK	JBS Titration Kit

DRUM PUMPS & ACCESSORIES



EZI-ACTION® DRUM PUMP

DRUM PUMPS & TOOLS

NZ Pump Co.

- Polypropylene and polyethylene construction
- Double action pump - continuous fast flow

PRICE	PART #	SIZE	OUTPUT/STROKE	SPOUT WIDTH	MAX. DEPTH TO BOTTOM
\$44.62	DPNZ5	5 gal.	6 oz.	20 mm	16½"
\$52.31	DPNZ15	15 gal.	15 oz.	20 mm	30"
\$60.00	DPNZ55	55 gal.	15 oz.	20 mm	36"

\$8.57 **DPNZ01** Ezi-Action Hose Kit: clear PVC 33" tube, tie and instructions

New!



FAST-FLO 55 GALLON DRUM PUMP

DRUM PUMPS & TOOLS

- Size: 1/2"-3/4"
- Flow: 4 GPM
- Pressure: 180 PSI
- Stainless Steel/Teflon Packed

\$2,090.00 **GD237129**



HUSKY DRUM PACKAGE

DRUM PUMPS & TOOLS

- Size: 1/4"
- Flow: 5 GPM
- Pressure: 100 PSI

\$375.61 **GDK5911**
\$100.73 **GDK241657**



ELECTRIC BARREL MIXER

DRUM PUMPS & TOOLS

- The only 100% stainless steel mixer designed for the car wash!

\$370.11 **CH1010**



BECKSON HAND PUMP

DRUM PUMPS & TOOLS

- Ounces per Stroke: 28 oz
- Adapter Type: Bung
- Hose Length: 3 ft
- Adapter Diameter: 2 in
- Piston Action Type
- Outlet Size: 1-1/4"
- Discharge Tube Outlet OD Size: 1-1/4"
- Discharge Tube Length: 36"

\$134.59 **CH1021**



SYPHON PUMP

DRUM PUMPS & TOOLS

- Easy-to-use design transfers liquids where needed
- Polyethylene construction is durable for long-lasting use
- Advanced design siphons 3.6 Gallons per minute
- Use for 15, 30 and 55-gallon drums with 2" National Pipe Thread

\$27.35 **CH1020**



DRUM WRENCH

DRUM PUMPS & TOOLS

- Remove plastic or metal drum bungs using this universal drum wrench

\$41.74 **CH1018**



CAP WRENCH

DRUM PUMPS & TOOLS

\$8.23 **DT1008**



PAIL OPENER

DRUM PUMPS & TOOLS

COLOR MAY VARY

- This 8" plastic lid opener is ideal for removing lids on 5 gallon pails

\$6.11 **CH1019**

HYDROMINDERS & ACCESSORIES

HYDROMINDERS

HYDRO SYSTEMS

- For a Constant Supply of Chemical Solution. Keep your reservoir ready at all times with accurately mixed solution. No pouring, stirring, or waiting. When the solution level drops in the reservoir, the float ball activates a magnetic valve. As water flows through your Hydrominder, it siphons liquid chemical through a metering tip to create a mixture of ready-to-use solution. The float automatically adjusts as fluid is added or removed from the holding so there is always enough solution for your customers to use. Self-contained and self-controlled. Easily installed.



PRICE	PART #	DESCRIPTION
\$135.48	IN506	4.5 GPM HydroMinder with Mounting Bracket
\$127.48	IN507	4.5 GPM HydroMinder
\$167.50	IN511	4.5 GPM HydroMinder with Siphon Breaker and Mounting Bracket
\$210.75	IN515	1.5 GPM HydroMinder with Siphon Breaker and Mounting Bracket
\$237.06	IN525	9.5 GPM HydroMinder with Mounting Bracket
\$319.14	IN530	9.0 GPM HydroMinder with Siphon Breaker and Mounting Bracket
\$438.74	IN561	18.0 GPM HydroMinder with Mounting Bracket
\$492.79	IN562	18.0 GPM HydroMinder with Siphon Breaker and Mounting Bracket
\$109.00	IN151	Dual Chemical Kit

HIGH VOLUME HYDROMINDERS

PRICE	PART #	SIPHON BREAKER	MOUNTING BRACKET	GPM @ 40 PSI	WEIGHT (LBS.)
\$436.20	IN563	YES	YES	25	11
\$375.61	IN564	NO	YES	25	10

WATER VALVES

PRICE	PART #	MOUNTING BRACKET	GPM @ 40 PSI	WEIGHT (LBS.)
\$238.99	IN572	YES	35+	9
\$174.69	IN573	NO	35+	5
\$133.36	IN502	YES	6.8	5

HYDROMINDER FOR ULTRA-CONCENTRATES

HYDRO SYSTEMS

- Designed to consistently keep reservoirs filled with accurately proportioned solutions of ultra-concentrate chemicals. When the level of solution contained in the reservoir drops, a float opens the magnetic valve enabling a flow of water to mix with a chemical concentrate ensuring a consistently mixed solution is dispensed into holding tanks. Perfect for pre-soak, detergent, special chemical applications, wax/protectants/rinse aids, and tire care

FEATURES & BENEFITS

- Uses water power – no electricity required
- Built with high quality, chemically resistant materials
- Economical, easy to operate and maintain – minimizes downtime
- Better chemical performance – designed specifically for use with ultra-concentrate car wash chemicals with dilution capability down to 2500:1
- Features ULD technology eliminating clogged metering tips
- Can be used with a variety of vehicle wash chemicals ranging from low to high pH
- Features our patented AccuPro Technology, eliminating dilution variance by controlling the amount of water allowed into the unit and never allowing it to “lean out” the desired dilution target

PRICE	PART #	DILUTION RANGE	GPM	WEIGHT (LBS.)
\$199.31	IN550CWTP	550:1-7:1	4-4.5GPM @ 40PSI	2.3 lbs
\$216.59	IN550CW	550:1-300:1	4-4.5GPM @ 40PSI	2.3 lbs
\$217.42	IN1000CW	1000:1-600:1	4-4.5GPM @ 40PSI	2.3 lbs
\$240.92	IN1700CW	1700:1-1100:1	4-4.5GPM @ 40PSI	2.3 lbs
\$216.59	IN2500CW	2500:1-1800:1	4-4.5GPM @ 40PSI	2.3 lbs

ULTRA LEAN DEVICE KITS

HYDRO SYSTEMS

- Ready to plug into your existing Ultra-Lean HydroMinder System. Ultra Lean Device Kits allow you access to the entire dilution range available when used with an Ultra Lean HydroMinder device.

PRICE	PART #	DILUTION RANGE	GPM @ 40 PSI
\$97.91	IN10099869	550:1 to 300:1	4-4.5GPM @ 40PSI
\$99.69	IN10099870	1000:1 to 600:1	4-4.5GPM @ 40PSI
\$100.65	IN10099871	1700:1 to 1100:1	4-4.5GPM @ 40PSI
\$100.65	IN10099872	2500:1 to 1800:1	4-4.5GPM @ 40PSI





DUAL EDUCTOR FOR HYDROMINDER

HYDRO SYSTEMS

- Compared to the standard 511 model with 14 metering tips, this 511E has 25 metering tips
- Reduced/simpler service -no more atmospheric vacuum breakers to repair/replace
- Dilution ratio 240:1 (max) to 4:1 (min)
- Includes siphon breaker and mounting bracket
- Consistent automatic dilution for better chemical performance
- Uses water power; no electricity required

APPLICATIONS:

- Automatic or self-serve vehicle washes
- High pressure cleaning systems
- Parts washing machines
- Water treatment systems



E-GAP DUAL PORT 3.5GPM KIT

HYDRO SYSTEMS

- 1 - Yellow dual port eductor
- 2 - Suction tube
- 2 - Weights
- 1 - Metering tip kit

\$105.61 IN10097393



HYDROMINDER - LOW VOLUME UNIT WITH SIPHON

HYDRO SYSTEMS

- Keep your reservoir ready at all times with accurately mixed solution. No pouring, stirring, or waiting. When the solution level drops in the reservoir, the float ball activates a magnetic valve. As water flows through your Hydrominder, it siphons liquid chemical through a metering tip to create a mixture of ready-to-use solution. The float automatically adjusts as fluid is added or removed from the holding so there is always enough solution for your customers to use. Self-contained and self-controlled. Easily installed.

\$167.50 IN511

\$198.84	IN511E	511 Dual Eductor
\$105.61	IN10097393	E-Gap Dual Port 3.5 GPM Kit



GRAY EPDM FOOT VALVE

HYDRO SYSTEMS

- For soap and wax

\$9.62	IN250100	Single
\$91.85	IN250100-10	10 Pack



BLUE VITON FOOT VALVE

HYDRO SYSTEMS

- For harsh chemicals

\$13.12	IN250020	Single
\$125.37	IN250020-10	10 Pack



SINGLE E-GAP EDUCTOR

HYDRO SYSTEMS

- Automatic mixing
- Environmentally friendly - using concentrates reduces solid waste
- Useful in a variety of applications
- HydroMinder units use water power, no electricity required
- High quality, chemically resistant materials
- Economical, easy to operate and maintain
- Improved employee safety - eliminates exposure to concentrated product

\$181.06 IN511ES



HYDROMINDER REPAIR KIT

KLEEN-RITE KITS

KLEEN-RITE.com

- Repair or replace parts for your Hydrominder the right way. Get all the essential parts that you need all in one convenient kit! Proper maintenance of your Hydrominder means more efficient gatekeeping of liquid chemical concentrates at your car wash. Save on an entire replacement unit by getting only the necessary components at a cost-efficient price
- **WILL SERVICE 502 - 511 HYDROMINDER**
- (2) 10076301 Hydro Systems Blue Foot Valve
- (1) 90093201 Hydro Systems Eductor Kit
- (2) 41.15.10 EPDM Diaphragm
- (1) 90093202 Hydro Systems Valve Parts Kit

\$66.07 INKRK2000

HYDROMINDERS & ACCESSORIES

HYDROMINDER TIPS

PRICE	TIP COLOR	PUSH-IN METER KIT #IN690014
\$1.71	Clear	IN690001
\$1.71	Gray	IN690012
\$1.71	Black	IN690011
\$1.71	Beige	IN690010
\$1.71	Red	IN690009
\$1.71	White	IN690025
\$1.71	Blue	IN690008
\$1.71	Tan	IN690007
\$1.71	Green	IN690006
\$1.71	Orange	IN690024
\$1.71	Brown	IN690005
\$1.71	Yellow	IN690004
\$1.71	Purple	IN690003
\$1.71	Pink	IN690002
\$1.71	Aqua	IN690016
-	Dark Blue	-

PRICE	TIP COLOR	THREADED TIP KIT #IN690015
-	Clear	-
\$2.15	Gray	IN690043
\$2.15	Black	IN690042
\$2.15	Beige	IN690041
\$2.15	Red	IN690040
\$2.15	White	IN690049
\$2.15	Blue	IN690039
\$2.15	Tan	IN690038
\$2.15	Green	IN690037
\$2.15	Orange	IN690048
\$2.15	Brown	IN690036
\$2.15	Yellow	IN690035
\$2.15	Purple	IN690046
\$2.15	Pink	IN690047
-	Aqua	-
\$2.15	Dark Blue	IN690068

PRICE	TIP COLOR	ULTRA LEAN TIP KIT #IN90031210
\$3.93	Pink	IN10027000
\$3.93	Light Purple	IN10027001
\$3.93	Olive	IN10027002
\$3.93	Red Purple	IN10027003
\$3.93	Light Orange	IN10027004



PUSH IN METER TIP KIT
HYDROMINDER REPAIR PARTS AND KITS

\$12.91 IN690014



THREADED METERING TIP KIT
HYDROMINDER REPAIR PARTS

\$12.48 IN690015



ULTRA LEAN TIP KIT
HYDROMINDER REPAIR PARTS AND KITS

\$16.96 IN90031210

HYDROMINDER REPAIR PARTS & KITS



MAGNET KIT - OLD STYLE
HYDROMINDER REPAIR PARTS

• For Models 506, 511, 530

\$33.88 IN5051K



MAGNET KIT - NEW STYLE
HYDROMINDER REPAIR PARTS

• For Models 506, 511, 525

\$22.30 IN10080500



PLASTIC VALVE BODY
HYDROMINDER REPAIR PARTS

• For Models 506, 511, 530

\$15.64 IN520000



VALVE PARTS KIT
HYDROMINDER REPAIR PARTS

• For Models 506, 511, 530, 545

\$22.89 IN6655K



EDUCTOR KIT
HYDROMINDER REPAIR PARTS

• For Models 506, 511

\$16.87 IN5037K



EPDM DIAPHRAGM
HYDROMINDER REPAIR PARTS

• For Models 502, 506, 507, 511

\$2.97 IN665500



SUCTION STUBS
HYDROMINDER REPAIR PARTS

• For Models 506, 511

\$1.00 IN5037-4



INLET STRAINER
HYDROMINDER REPAIR PARTS

• With washer

\$0.97 IN238100



VALVE PART KIT
HYDROMINDER REPAIR PARTS

• With Bonnet - For 506, 507, 511

\$14.48 IN665520

CHEMICALS



HYDROMINDER REPAIR PARTS & KITS



ACTUATOR ASSEMBLY
HYDROMINDER REPAIR PARTS

- For Models 572, 573

\$83.89 IN10091907



DIAPHRAGM KIT
HYDROMINDER REPAIR PARTS

- For Models 561, 562, 572, 573

\$56.87 IN10091906



SIPHON BREAKER
HYDROMINDER REPAIR PARTS

- For Models 551, 561

\$100.14 IN507600



EDUCTOR KIT
HYDROMINDER REPAIR PARTS

- For Models 545, 550

\$116.46 IN5083-K



EDUCTOR ASSEMBLY
HYDROMINDER REPAIR PARTS

- 4 GPM

\$14.71 IN441210



EDUCTOR BODY
HYDROMINDER REPAIR PARTS

- Body Only

\$11.96 IN440100



EDUCTOR KIT
HYDROMINDER REPAIR PARTS

- High Concentrate

\$16.59 IN440321



ULTRA LEAN 1/4" BARB
HYDROMINDER REPAIR PARTS

- Hose barb assembly

\$1.00 IN3401-R



FLOAT & CHAIN ASSEMBLY
HYDROMINDER REPAIR PARTS

- For all models

\$24.32 IN5043-A



CERAMIC WEIGHT
HYDROMINDER REPAIR PARTS

- 1/4" I.D. x 1/2" O.D.

\$5.60 IN250006



SUCTION TUBE ASSEMBLY
HYDROMINDER REPAIR PARTS

- 9" With Foot Valve

\$37.18 IN50589A



DISCHARGE TUBE
HYDROMINDER REPAIR PARTS

- 2' Assembly

\$9.18 IN5057-A



MAGNET SPRING
HYDROMINDER REPAIR PARTS

- For all models

\$2.92 IN503200



HYDROMINDER SCREWS
HYDROMINDER REPAIR PARTS

- Security screws

\$0.85 IN641751



FOOT VALVE WEIGHT
HYDROMINDER REPAIR PARTS

- Ceramic

\$3.16 IN509900



CLAMP RING
HYDROMINDER REPAIR PARTS

- For 1/2" Tubing

\$1.36 IN5093-7



Watch our *How To Service, Clean & Rebuild A Hydrominder* video on our YouTube Channel.

Don't forget to subscribe!



GRAY FOOT VALVE
HYDROMINDER REPAIR PARTS

- EPDM

\$8.82 IN10076304



BLUE FOOT VALVE
HYDROMINDER REPAIR PARTS

- Viton

\$11.58 IN10076303

FLOAT VALVES

AQUA MASTER

DEMA

- The premier reservoir mounted float valve system
- Compare the Aqua Master to other reservoir systems and see the difference. The new, more economical unit is designed to reduce service and potential problems.
- Superior float valve design avoids hang-ups and flooded floors.
- Float is filled with water soluble granular material instead of system clogging sand.
- 90 degree chemical metering barb rotates 180° to avoid kinking problems of straight barbs.
- New design mounting bracket has identical dimensions of competitive bracket.
- Tip kit and competitive metering tip cross reference included with every unit.

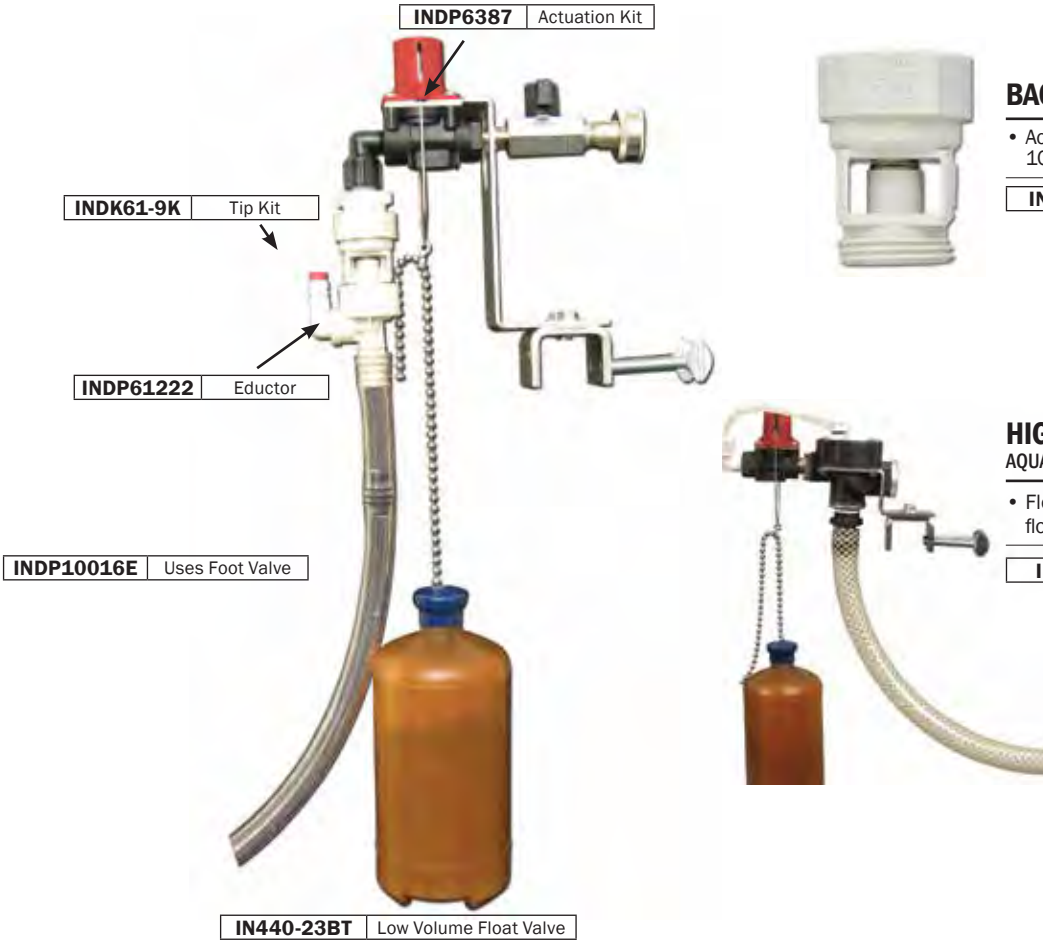

BACKFLOW PREVENTER

- Action Gap Backflow Preventer meets ASSE 1055B for backflow prevention.

INDP1630

HIGH VOLUME FLOAT VALVE

AQUA MASTER

- Float valve design avoids hang-ups and flooded floors

IN437PN

PRICE	PART #	BACK FLOW PREVENTION	BRACKET	MIN	MAX	GPM 40 PSI
LOW VOLUME						
\$118.13	IN440-22T	No	Yes	430:1	4:1	4.0
\$121.41	IN440-23T	Yes	Yes	430:1	4:1	4.0
\$119.33	IN440-23BT	Yes	Yes	387:1	7:1	4.0
\$135.71	IN440-24	Yes	Yes	195:1	2:1	2.5
HIGH VOLUME						
\$258.39	IN437P21	Yes	Yes	512:1	10:1	22.0
VALVE ONLY						
\$95.43	Low Volume: IN440N		Yes	-	-	6.0
\$152.44	High Volume: IN437PN		Yes	-	-	64.0



HIGH VOLUME PROPORTIONER WITH SIPHON BREAKER

AQUA MASTER

- High volume with siphon breaker

IN437P-21

HYDRA-FLEX CHEMICAL INJECTORS

CHEM-FLEX™ CHEMICAL INJECTORS

HYDRA-FLEX

- 3/8" NPT stainless steel inlet and outlet ports.
- Rated to 1000 PSI and 175°F
- Dual material construction combines the excellent corrosion and chemical resistance of Kynar® with the mechanical strength of stainless steel.



IN118057

IN129098



IN118083



IN129117

SINGLE BARB

CHEM-FLEX

FLOW RATE BASED ON 200 PSI

PRICE	PART #	GPM	NOZZLE	COLOR
\$56.30	IN118057	1.0	.057	Red
\$56.30	IN118070	1.5	.070	Orange
\$56.30	IN118083	2.0	.083	Gray
\$56.30	IN118086	2.25	.086	Blue
\$56.30	IN118095	3	.095	Light Blue
\$56.30	IN118098	3.25	.098	Light Green
\$56.30	IN118106	3.75	.106	Pink
\$56.30	IN118117	4.5	.117	Purple
\$56.30	IN118125	5.5	.125	Dark Green

DUAL BARB - 60°

CHEM-FLEX

FLOW RATE BASED ON 200 PSI

PRICE	PART #	GPM	NOZZLE	COLOR
\$72.80	IN129057	1.0	.057	Red
\$72.80	IN129070	1.5	.070	Orange
\$72.80	IN129083	2.0	.083	Gray
\$72.80	IN129086	2.25	.086	Blue
\$72.80	IN129095	3	.095	Light Blue
\$72.80	IN129098	3.25	.098	Light Green
\$72.80	IN129106	3.75	.106	Pink
\$72.80	IN129117	4.5	.117	Purple
\$72.80	IN129125	5.5	.125	Dark Green

CHEM-FLEX™ COMPOSITE PC1 INJECTORS

HYDRA-FLEX

- PC1 inlet port
- 1/4" MNPT outlet port
- Rated to 250 PSI and 140°F
- Constructed with corrosion-resistant composite material
- Includes Hastelloy® spring, Teflon® check ball and exclusive XFC o-ring material

FOR USE WITH AQUA-LAB MODEL SD (GEN 2 ONLY)



IN318040

IN318051



IN329057



IN329095

SINGLE BARB

CHEM-FLEX

FLOW RATE BASED ON 200 PSI

PRICE	PART #	GPM	NOZZLE	COLOR
\$54.50	IN318040	0.50	0.040	Yellow
\$54.50	IN318051	0.75	0.051	Tan
\$54.50	IN318057	1.00	0.057	Red
\$54.50	IN318070	1.50	0.070	Orange
\$54.50	IN318083	2.00	0.083	Gray
\$54.50	IN318086	2.25	0.086	Dark Blue
\$54.50	IN318095	3.00	0.095	Light Blue
\$54.50	IN318098	3.25	0.098	Light Green
\$54.50	IN318106	3.75	0.106	Pink

DUAL BARB

CHEM-FLEX

FLOW RATE BASED ON 200 PSI

PRICE	PART #	GPM	NOZZLE	COLOR
\$69.80	IN329040	0.50	0.040	Yellow
\$69.80	IN329051	0.75	0.051	Tan
\$69.80	IN329057	1.00	0.057	Red
\$69.80	IN329070	1.50	0.070	Orange
\$69.80	IN329083	2.00	0.083	Gray
\$69.80	IN329086	2.25	0.086	Dark Blue
\$69.80	IN329095	3.00	0.095	Light Blue
\$69.80	IN329098	3.25	0.098	Light Green
\$69.80	IN329106	3.75	0.106	Pink

CHEM-FLEX™ COMPOSITE PC2 INJECTORS

HYDRA-FLEX

- PC2 inlet port
- 3/8" MNPT outlet port
- Rated to 250 PSI and 140°F
- Constructed with corrosion-resistant composite material.
- Includes Hastelloy® spring, Teflon® check ball and exclusive XFC o-ring material

FOR USE WITH AQUA-LAB MODEL SD, EVO, MD, XD



IN718029

IN718106



IN729125



IN729117

SINGLE BARB

CHEM-FLEX

FLOW RATE BASED ON 200 PSI

PRICE	PART #	GPM	NOZZLE	COLOR
\$76.40	IN718029	0.25	0.029	White
\$76.40	IN718040	0.50	0.040	Yellow
\$76.40	IN718051	0.75	0.051	Tan
\$76.40	IN718057	1.00	0.057	Red
\$76.40	IN718070	1.50	0.070	Orange
\$76.40	IN718083	2.00	0.083	Gray
\$76.40	IN718086	2.25	0.086	Dark Blue
\$76.40	IN718095	3.00	0.095	Light Blue
\$76.40	IN718098	3.25	0.098	Light Green
\$76.40	IN718106	3.75	0.106	Pink
\$76.40	IN718117	4.50	0.117	Purple
\$76.40	IN718125	5.50	0.125	Dark Green

DUAL BARB

CHEM-FLEX

FLOW RATE BASED ON 200 PSI

PRICE	PART #	GPM	NOZZLE	COLOR
\$97.80	IN729029	0.25	0.029	White
\$97.80	IN729040	0.50	0.040	Yellow
\$97.80	IN729051	0.75	0.051	Tan
\$97.80	IN729057	1.00	0.057	Red
\$97.80	IN729070	1.50	0.070	Orange
\$97.80	IN729083	2.00	0.083	Gray
\$97.80	IN729086	2.25	0.086	Dark Blue
\$97.80	IN729095	3.00	0.095	Light Blue
\$97.80	IN729098	3.25	0.098	Light Green
\$97.80	IN729106	3.75	0.106	Pink
\$97.80	IN729117	4.50	0.117	Purple
\$97.80	IN729125	5.50	0.125	Dark Green

HYDRA-FLEX CHEMICAL INJECTORS

VERSADIAL™ COMPOSITE PC1 QUICK CONNECT INJECTORS



IN317083

IN327095

FOR USE WITH SAM VALVES & VERSADIAL™ CHEMICAL CONTROL DEVICES ONLY

- 1/4" MNPT
- Max. Pressure: 250 PSI
- Hastelloy spring and Teflon check ball
- Temp. Range: 40 - 140°F
- Exclusive XFC O-Ring
- Color coded for application

SINGLE BARB

VERSADIAL

FLOW RATE BASED ON 200 PSI

PRICE	PART #	GPM	COLOR
\$67.10	IN317029	0.25	White
\$67.10	IN317040	0.50	Yellow
\$67.10	IN317051	0.75	Tan
\$67.10	IN317057	1.0	Red
\$67.10	IN317070	1.5	Orange
\$67.10	IN317083	2.0	Gray
\$67.10	IN317086	2.25	Dark Blue
\$67.10	IN317095	3.0	Light Blue
\$67.10	IN317098	3.25	Light Green
\$67.10	IN317106	3.75	Pink
\$67.10	IN317125	5.5	Dark Green

DUAL BARB

VERSADIAL

FLOW RATE BASED ON 200 PSI

PRICE	PART #	GPM	COLOR
\$82.20	IN327040	0.50	Yellow
\$82.20	IN327051	0.75	Tan
\$82.20	IN327057	1.0	Red
\$82.20	IN327070	1.5	Orange
\$82.20	IN327083	2.0	Gray
\$82.20	IN327086	2.25	Dark Blue
\$82.20	IN327095	3.0	Light Blue
\$82.20	IN327098	3.25	Light Green
\$82.20	IN327106	3.75	Pink

VERSADIAL™ COMPOSITE PC2 QUICK CONNECT INJECTORS



IN717098

IN727125

FOR USE WITH SAM VALVES & VERSADIAL™ CHEMICAL CONTROL DEVICES ONLY

- 3/8" MNPT
- Max. Pressure: 250 PSI
- Hastelloy spring and Teflon check ball
- Temp. Range: 40 - 140°F
- Exclusive XFC O-Ring
- Color coded for application

SINGLE BARB

VERSADIAL

FLOW RATE BASED ON 200 PSI

PRICE	PART #	GPM	COLOR
\$89.00	IN717029	0.25	White
\$89.00	IN717040	0.50	Yellow
\$89.00	IN717051	0.75	Tan
\$89.00	IN717057	1.0	Red
\$89.00	IN717070	1.5	Orange
\$89.00	IN717083	2.0	Gray
\$89.00	IN717086	2.25	Dark Blue
\$89.00	IN717095	3.0	Light Blue
\$89.00	IN717098	3.25	Light Green
\$89.00	IN717106	3.75	Pink
\$89.00	IN717117	4.5	Purple
\$89.00	IN717125	5.5	Dark Green

DUAL BARB

VERSADIAL

FLOW RATE BASED ON 200 PSI

PRICE	PART #	GPM	COLOR
\$110.30	IN727029	0.25	White
\$110.30	IN727040	0.50	Yellow
\$110.30	IN727051	0.75	Tan
\$110.30	IN727057	1.0	Red
\$110.30	IN727070	1.5	Orange
\$110.30	IN727083	2.0	Gray
\$110.30	IN727086	2.25	Dark Blue
\$110.30	IN727095	3.0	Light Blue
\$110.30	IN727098	3.25	Light Green
\$110.30	IN727106	3.75	Pink
\$110.30	IN727117	4.5	Purple
\$110.30	IN727125	5.5	Dark Green

QUICK CONNECT PC3 SINGLE HOSE BARB



FOR USE WITH BAM VALVES & VERSADIAL™ CHEMICAL CONTROL DEVICES ONLY

- Boasts superb chemical resistance against even the most aggressive car wash chemicals. Industry-proven composite material construction ensures longevity and reliable servicing.

PRICE	PART #	GPM	NOZZLE	PRICE	PART #	GPM	NOZZLE	FLOW RATE BASED ON 200 PSI
\$125.30	IN818161	8.0	0.161	\$125.30	IN818186	12.0	.0186	
\$125.30	IN818177	10.0	0.177	\$125.30	IN818207	15.0	0.207	



STANDARD METERING TIPS

- Set of 14 standard, screw in chemical metering tips to proportion the correct chemical mix ratios in combination with NPT or PC1, PC2, and PC3 Chem-Flex Standard -SST and All-Composite Injectors
- Crosses to Sonny's Part #40011493

\$15.50 IN1000643

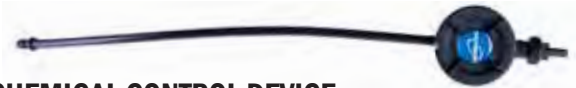

VERSADIAL™ CHEMICAL CONTROL DEVICE

- 32 unique settings allow you to work with the lowest possible concentrations
- Improved reliability & consistency - internal disc utilizes a long, torturous channel, eliminating clogs, requiring less maintenance and replacements
- Correct amount of chemistry is delivered every time
- Eliminates the need to physically change tips or find colors - just rotate the dial to your desired dilution. Eliminates the need to interact directly with chemistry

PRICE	PART #	DESCRIPTION
\$112.80	IN1002531	VersaDial™ Device - Includes Filter, Chemical Control Dial & Quick Connect (shown)
\$63.90	IN1002987	VersaDial™ Filter - 5 Pack
\$30.30	IN1003017	VersaDial™ Mount Kit
\$22.40	IN1003027	VersaDial™ QC 1/4" Hose Barb

CHEMICAL INJECTORS

ADJUSTABLE INJECTORS

CAT PUMPS



- MAX. PSI: 3500
- O-RING: Viton
- INLET/OUTLET: 3/8" NPTM
- MAX. TEMP.: 195°F

PRICE	PART #	GPM	STAINLESS STEEL ORIFICE
\$26.55	PU7182	2-4	1.8 mm
\$26.55	PU7183	3-5	2.1 mm
\$26.55	PU7184	3-6	2.3 mm



CHEMICAL INJECTORS

SUTTNER



- HOUSING: Forged brass
- SPRING: Stainless steel
- INLET: 3/8" MNPT
- HOSE BARB: 1/4"
- O-RING: Viton
- BALL: Stainless steel
- OUTLET: 3/8" FNPT

PRICE	PART #	ORIFICE
\$16.47	SUT60-1.8	1.8
\$16.18	SUT60-2.1	2.1
\$16.45	SUT60-2.4	2.4

FIXED & ADJUSTABLE INJECTORS

GIANT INDUSTRIES



- INLET: 3/8" MNPT
- MAX. TEMP.: 194°F
- OUTLET: 3/8" MNPT
- MAX. PSI: 4000

PRICE	PART #	ORIFICE	TYPE
\$13.23	PU25170-1.8	1.8 mm	Fixed
\$18.27	PU25170-1.8A	1.8 mm	Adjustable
\$13.23	PU25170-2.1	2.1 mm	Fixed

PRICE	PART #	ORIFICE	TYPE
CALL	PU25170-2.1A	2.1 mm	Adjustable
\$13.23	PU25170-2.3	2.3 mm	Fixed
\$18.27	PU25170-2.3A	2.3 mm	Adjustable

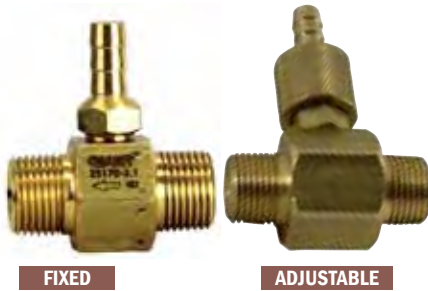

ADJUSTABLE SIPHON INJECTOR

SPRAYING SYSTEMS CO.

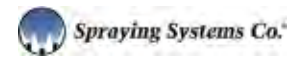

- 1" square brass
- INDEXED: Indexed metering screw for consistent, adjustable siphon control (Dial Control Design)
- LOCK-NUT: Lock-nut on metering screw to hold siphon setting during system vibration
- MAX PRESS.: 3000 PSI
- USE: Use in 2-fluid application when pre-mix is involved

PRICE	PART #	THREAD	GPM
\$97.77	SSI50586-10	3/8"	1.0
\$97.77	SSI50586-15	3/8"	1.5
\$97.77	SSI50586-20	3/8"	2.0
\$97.77	SSI50586-25	3/8"	2.5
\$97.77	SSI50586-40	3/8"	4.0

PRICE	PART #	THREAD	GPM
\$97.77	SSI50586-50	3/8"	5.0
\$97.77	SSI50588-05	1/2"	0.5
\$97.77	SSI50588-10	1/2"	1.0
\$97.77	SSI50588-15	1/2"	1.5
\$97.77	SSI50588-20	1/2"	2.0

PRICE	PART #	THREAD	GPM
\$97.77	SSI50588-30	1/2"	3.0
\$97.77	SSI50588-40	1/2"	4.0
\$97.77	SSI50588-50	1/2"	5.0
\$97.77	SSI50588-60	1/2"	6.0



STAINLESS STEEL CHEMICAL INJECTOR

GENERAL PUMP



- 1/4" hose barb
- EPDM O-Ring
- Teflon ball
- Kynar hose barb
- MAX. TEMP.: 190°F
- INLET/OUTLET: 3/8"
- Stainless steel nozzle

PRICE	PART #	ORIFICE	GPM
\$49.80	GPP100096	1.45 mm	1.0 - 2.0
\$49.80	GPP100097	2.2 mm	3.0 - 5.0



STAINLESS STEEL CHEMICAL INJECTOR

GENERAL PUMP



- 5500 PSI
- 3/8" M Inlet/Outlet
- Stainless steel nozzle EPDM elastomers
- 190°F Max Temp.
- Stainless Steel Ball

PRICE	PART #	ORIFICE	GPM	BARB
\$47.45	GPP100075	1.45 mm	1-2	1/4"
\$47.45	GPP100093	2.1 mm	2-4	1/4"
\$47.45	GPP100076	2.5 mm	5-8	1/4"
\$66.63	GPP100541	2.1 mm	3-5	1/4" Dual



GPP100541



CHEMICAL INJECTORS



CPVC CHEMICAL INJECTOR GENERAL PUMP



- 4500 PSI
- CPVC nozzle
- 1/4" Kynar hose barb
- 190°F Max. Temp.
- Viton O-Ring
- Teflon ball

PRICE	PART #	ORIFICE	GPM	INLET/ OUTLET
\$30.55	GPP100938	1.6 mm	2-3	3/8" M
\$30.55	GPP100853	2.1 mm	3-5	3/8" M
\$37.10	GPP100955	1.4 mm	1-2	1/2" M
\$45.10	GPP100956	1.6 mm	2-3	1/2" M
\$45.10	GPP100957	2.1 mm	3-5	1/2" M



BRASS CHEMICAL INJECTOR GENERAL PUMP



- 4500 PSI
- 190°F Max. Temp.
- 1/4" hose barb
- Ceramic ball
- Viton elastomers
- 3/8" M Inlet/Outlet
- Stainless steel nozzle
- High draw injection

PRICE	PART #	ORIFICE	GPM
\$14.39	GPP100947	1.6 mm	2-3
\$14.39	GPP100948	1.8 mm	2-3
\$14.39	GPP100949	2.1 mm	3-5
\$14.39	GPP100950	2.3 mm	5-8



BRASS CHEMICAL INJECTOR GENERAL PUMP



- 4000 PSI
- 1/4" hose barb
- Teflon ball
- Viton elastomers
- 190°F Max. Temp.
- 3/8" M Inlet/Outlet
- Stainless steel nozzle
- Hastelloy spring

PRICE	PART #	ORIFICE	GPM
\$27.25	GPP100871	1.5 mm	1-2
\$32.91	GPP100872	2.3 mm	5-8



BRASS CHEMICAL INJECTOR GENERAL PUMP



- 4000 PSI
- 1/4" hose barb
- Stainless steel ball
- Viton elastomers
- 190°F Max. Temp.
- 3/8" M Inlet/Outlet
- Stainless steel nozzle

PRICE	PART #	ORIFICE	GPM
\$22.50	GPP100913	1.45 mm	1-2
\$22.50	GPP100615	1.8 mm	2-3
\$22.50	GPP100511	2.1 mm	3-5



STAINLESS STEEL CHEMICAL INJECTOR GENERAL PUMP



- 5500 PSI
- 190°F Max. Temp.
- 3/8" M Inlet/Outlet
- Stainless steel nozzle
- Viton elastomers
- Stainless steel ball

PRICE	PART #	ORIFICE	GPM	BARB	COLOR
\$37.40	GPP100336	1.45 mm	1-2	1/4"	Red
\$47.45	GPP100094	1.6 mm	2-3	1/4"	White
\$47.45	GPP100835	1.8 mm	2-3	1/4"	Orange

PRICE	PART #	ORIFICE	GPM	BARB	COLOR
\$37.40	GPP100334	2.1 mm	2-4	1/4"	Gray
\$37.40	GPP100333	2.2 mm	3-5	1/4"	Blue
\$37.40	GPP100339	2.5 mm	5-8	1/4"	Light green

FIXED EXTERNAL CHEMICAL INJECTOR KITS

X-JET



SPECIFICATIONS:

- **PRESSURE:** 2000 to 4000 PSI
- **FLOW:** See Specific Model Below
- **MAX. TEMP:** 190°F
- **INLET:** 1/4" QC Plug
- **CHEM PORT:** 1/8" MPT x 3/8" Hose Barb

INCLUDED ACCESSORIES:

- 15' X-Jet Suction Hose with hose barb
- Long range nozzle
- Low pressure close range nozzle
- 15-piece color coded proportioner tip set
- Shut off ball valve
- Mushroom strainer

PRICE	KR #	GPM
\$126.75	XJET-07K	2 - 2.5
\$126.75	XJET-09K	3 - 3.5
\$126.75	XJET-13K	4 - 4.5

PRICE	KR #	GPM
\$126.75	XJET-16K	5 - 6.5
\$126.75	XJET-20K	7 - 8
\$126.75	XJET-25K	8.5+



X-JET M5 KIT - ADJUSTABLE EXTERNAL INJECTOR

X-JET



SPECIFICATIONS:

- **PRESSURE:** 2000 to 4000 PSI
- **FLOW:** See Specific Model Below
- **MAX. TEMP:** 190°F
- **INLET:** 1/4" QC Plug
- **CHEM PORT:** 1/8" MPT x 3/8" Hose Barb

INCLUDED ACCESSORIES:

- 15' X-Jet Suction Hose with hose barb
- Twist-adjust M5 nozzle for spray patterns between 5° & 60°
- 15-piece color coded proportioner tip set
- Shut off ball valve
- Mushroom strainer

PRICE	KR #	GPM
\$141.75	XJETM5-07K	2 - 2.5
\$141.75	XJETM5-09K	3.0 - 3.5
\$141.75	XJETM5-13K	4 - 4.5

PRICE	KR #	GPM
\$141.75	XJETM5-16K	5 - 6.5
\$141.75	XJETM5-20K	7 - 8
\$141.75	XJETM5-25K	8.5+





CHEMICAL INJECTORS

B SERIES INJECTORS

DEMA ENGINEERING



- Incorporates an externally adjustable, internal bypass valve plus a chemical injection metering screw. Eliminates need for water flow nozzle bushings, extends flow range of injector and adapts easily to variations in liquid flow.

• **MAX. TEMP.:** 180°F • Metering tip model avail.

PRICE	PART #	SIZE	PRICE	PART #	SIZE
\$62.02	IN202B	3/8"	\$67.32	IN204B	1/2"
\$62.02	IN203B	3/8"	\$84.31	IN206B	3/4"



C SERIES INJECTORS

DEMA ENGINEERING



- Injectors have adjustable stainless steel metering screw for adjustments to chemical injection.
- Metering tip model also available

PRICE	PART #	SIZE	PRICE	PART #	SIZE
\$48.90	IN2003C	1/8"	\$54.39	IN204C	1/2"
\$48.90	IN200C	1/8"	\$67.09	IN206C	3/4"
\$48.90	IN202C	1/4"	\$97.86	IN208C	1"
\$51.67	IN203C	3/8"			



DEMA ENGINEERING COMPANY
100-15K METERING TIP KIT FOR 1/4" HOSE BARBS
10020 Big Bend Blvd., St. Louis, MO 63122
Phone: (314) 966-3533 Toll Free: (800) 325-3362 Fax: (314) 965-8319

PROPORTIONER MODELS 164C & 164BAG & BLEND CENTERS (1 GPM / 3.8 LPM)				PROPORTIONER MODELS 163C & 163BAG & BLEND CENTERS (4 GPM / 15.1 LPM)			
TIP	RATIO	oz/gal.	mL/L	TIP COLOR	RATIO	oz/gal.	mL/L
Tan	102:1	1.25	7.8	Tan	427:1	0.30	1.9
Orange	75:1	1.70	10.5	Orange	320:1	0.40	2.5
Turquoise	60:1	2.15	13.3	Turquoise	256:1	0.50	3.1
Pink	43:1	3.00	18.6	Pink	170:1	0.75	4.7
Light Blue*	33:1	3.90	24.2	Light Blue*	128:1	1.00	6.2
Brown	28:1	4.55	28.2	Brown	114:1	1.12	6.9
Red	22:1	5.80	36.0	Red	85:1	1.50	9.3
White	18:1	7.00	43.4	White	73:1	1.75	10.9
Green	16:1	7.90	49.0	Green	70:1	2.00	12.4
Blue	13:1	9.80	60.8	Blue	51:1	3.00	15.5
Yellow	9:1	14.80	91.8	Yellow	31:1	5.00	23.3
Black	6:1	20.15	124.9	Black	20:1	7.50	31.0
Purple	5:1	27.80	172.4	Purple	15:1	10.00	37.7
Gray	4:1	31.60	195.9	Gray	10:1	15.00	51.3
None	3.6:1	35.00	217.0	None	7:1	21.40	80.8

* Metering tip color was formerly clear.
Chemical induction rates are based on water thin products (1 CPS). Induction rates may vary from product to product. Field tests are recommended.



METERING TIP KIT

DEMA ENGINEERING

\$9.82	INDK100-15K	Regular
\$5.81	INDK100-15KU	Ultra Lean
\$10.88	INDK61-9K	Large for 3/8" Barb



METERING TIP KIT

DEMA ENGINEERING

- For All 1/4" Barb Dema Injectors and Blend Centers

\$9.82	INDK100-15K
--------	-------------



LARGE METERING TIP KIT

DEMA ENGINEERING

- 13 metering tips with a screw-in style for easy installation and removal
- Fits 3/8 inch hose barb connections

\$10.88	INDK61-9K
---------	-----------



ULTRA LEAN METERING TIP KIT

DEMA ENGINEERING

- Push-in style metering tip kit.
- Fits 1/4 inch hose barb connections

\$5.81	INDK100-15KU
--------	--------------



DEMA CHEMICAL INJECTORS

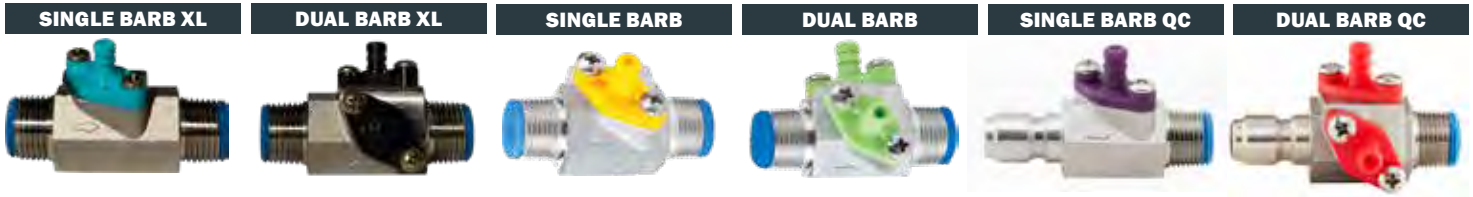

ROCKET HIGH PERFORMANCE INJECTOR

DEMA

- The Rocket injector was designed to be the most versatile venture injector in the marketplace. Designed to be serviceable and last for a lifetime and not a season. The Rocket is the most efficient injector, with the lowest pressure loss amongst competitive units, delivering more pressure for any application. It enables cleaning at greater pressure while consuming less chemicals. With the use of a removable nozzle and metering barb, it makes maintenance and repair extremely simple, extending the life of the injector and reducing the cost of ownership. It has the greatest range of any injector on the market.

XL SINGLE BARB - 200 PSI



PRICE	PART #	GPM	COLOR
\$82.82	IN211161	8.7	Gray
\$82.82	IN211177	10.6	Turquoise
\$82.82	IN211185	11.4	Orange
\$82.82	IN211206	14.2	Black

XL DUAL BARB - 200 PSI



PRICE	PART #	GPM	COLOR
\$95.90	IN221161	8.7	Gray
\$95.90	IN221177	10.6	Turquoise
\$95.90	IN221185	11.4	Orange
\$95.90	IN221206	14.2	Black

SINGLE BARB - 200 PSI



PRICE	PART #	REPAIR KIT	GPM	COLOR
\$51.34	IN211057	INK21057	1.1	Red
\$51.34	IN211070	INK21070	1.7	Orange
\$51.34	IN211083	INK21083	2.4	Gray
\$51.34	IN211086	INK21086	2.6	Blue
\$51.34	IN211098	INK21098	3.4	Light Green
\$51.34	IN211116	INK21116	4.3	Purple
\$51.34	IN211125	INK21125	5.3	Dark Green
\$54.71	IN211029	INK21029	0.30	White
\$54.71	IN211040	INK21040	0.55	Yellow
\$54.71	IN211051	INK21051	0.85	Tan

DUAL BARB - 200 PSI



PRICE	PART #	REPAIR KIT	GPM	COLOR
\$64.41	IN221057	INK22057	1.1	Red
\$64.41	IN221070	INK22070	1.7	Orange
\$64.41	IN221083	INK22083	2.4	Gray
\$64.41	IN221086	INK22086	2.6	Blue
\$64.41	IN221098	INK22098	3.4	Light Green
\$64.41	IN221116	INK22116	4.3	Purple
\$64.41	IN221125	INK22125	5.3	Dark Green
\$67.77	IN221029	INK22029	0.30	White
\$67.77	IN221040	INK22040	0.40	Yellow
\$67.77	IN221051	INK22051	0.60	Tan

QUICK CONNECT SINGLE BARB - 200 PSI



PRICE	PART #	ORIFICE	GPM	COLOR
\$63.07	IN311029	0.029	.25	White
\$63.07	IN311040	0.040	.50	Yellow
\$63.07	IN311051	0.051	.75	Tan
\$59.73	IN311057	0.057	1.1	Red
\$59.73	IN311070	0.070	1.7	Orange
\$59.73	IN311083	0.083	2.4	Gray
\$59.73	IN311086	0.086	2.6	Blue
\$59.73	IN311098	0.098	3.4	Light Green
\$59.73	IN311116	0.116	4.3	Purple
\$59.73	IN311125	0.125	5.3	Dark Green
\$59.73	IN311136	0.136	6.1	Brown

New!

QUICK CONNECT DUAL BARB - 200 PSI



PRICE	PART #	ORIFICE	GPM	COLOR
\$76.15	IN321029	0.029	.25	White
\$76.15	IN321040	0.040	.50	Yellow
\$76.15	IN321051	0.051	.75	Tan
\$72.79	IN321057	0.057	1.1	Red
\$72.79	IN321070	0.070	1.7	Orange
\$72.79	IN321083	0.083	2.4	Gray
\$72.79	IN321086	0.086	2.6	Blue
\$72.79	IN321098	0.098	3.4	Light Green
\$72.79	IN321116	0.116	4.3	Purple
\$72.79	IN321125	0.125	5.3	Dark Green
\$72.79	IN321136	0.136	6.1	Brown

New!

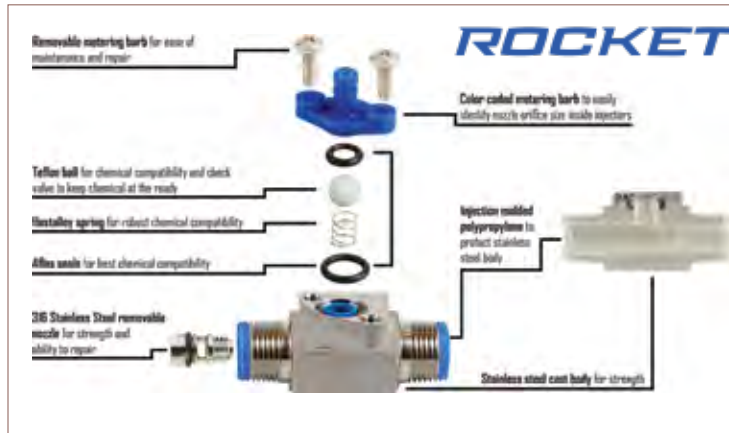

- What if you could modify an injector when the application changes, rather than replace it?
- What if you could fully field service an injector, rather than replace it?
- What if you could save money on your overall cost of ownership for an injector, making it the only injector you need?

What makes the Rocket unique?

It's the most efficient injector in the market. With the lowest pressure loss among competitive units, the Rocket delivers more pressure for any application. The Rocket enables cleaning at higher pressures while consuming less chemicals overall.

Rocket is simple to repair. We believe that when you buy an injector, you buy it for the long haul, not to be replaced a year down the road. With the use of a removable nozzle and metering barb, the Rocket makes maintenance and repair simple, extending the life of an injector well beyond what you thought was possible.



STAINLESS STEEL QUICK COUPLER SOCKET

DEMA

- 3/8" MNPT

\$21.20 INP0215



QUICK COUPLER ADAPTER

DEMA

- 3/8" MNPT

\$14.92 INP0210

FOR USE WITH ROCKET INJECTORS!



CHEMICALS

DEMA

PROPORTIONERS

DEMA
MixRite



MR50411
3/4" Female Strainer
for 500 Series
80 Micron filter cleans
up any installation and
improves water quality and
length of service for MixRite



SAME UNIT DIFFERENT OPTIONS
Chemical Shut-off (Models 571, 573, 575)

WATER POWERED PROPORTIONING PUMPS DEMA MIXRITE

- Chemically Resistant Nylon - Fiberglass body
- All seals specifically designed to withstand car wash additives.
- Easily replaceable wear parts.
- Extra Lip Seal Piston Kit included with each unit
- Higher 120 PSI operating range. 2.9 PSI to 120 PSI
- Optional Tip Kit, p/n 57-11-1 for dilutions from 750:1 to 2000:1.
- Accurate dispensing
- Uses only 20% of pressure to drive the pump
- Low maintenance and easy to adjust
- No special model needed
- Hose barbs with swivel for easy installation
- Injection from 300:1 to 1:10 (.3% to 10%)
- Includes 7 ft. 3/8" inlet tubing with foot valve strainer
- Check Valve with Hastelloy spring
- 19 1/2" high, 7" wide

AIR RELEASE MODELS

PRICE	PART #	PSI	RATIO	PERCENT	OZ/GAL	GPM	APPLICATIONS
\$371.55	MR570CW	2.9 - 120	500:1 - 50:1	.3% - 2%	.38 - 2.5	.09 - 11	Car wash cleaning agents & detergents
\$371.55	MR572CW	2.9 - 120	250:1 - 25:1	.4% - 4%	.51 - 5.1	.09 - 11	Car wash cleaning agents & detergents
\$436.82	MR1402A	2.9 - 120	333:1 - 50:1	.3% - 2%	.38 - 2.56	.5 - 14	Car wash applications including Hydrofluoric acids, tire cleaners, chlorine
\$624.42	MR570PVPDF	2.9 - 120	333:1 - 50:1	0.3% - 2%	.38 - 2.56	.5 - 14	All Hastelloy Springs & PVDF Components for aggressive chemicals
\$584.13	MR1410A	2.9 - 120	100:1 - 10:1	1% - 10%	1.28 - 12.8	.09 - 14	Car wash applications, hydrofluoric acids, tire cleaners, chlorine

California Proposition 65

CHEMICAL ON/OFF MODELS

PRICE	PART #	PSI	RATIO	PERCENT	OZ/GAL	GPM	APPLICATIONS
\$385.67	MR571CW	2.9 - 120	500:1 - 50:1	.3% - 2%	.38 - 2.5	.09 - 11	Car wash cleaning agents & detergents
\$385.67	MR573CW	2.9 - 120	250:1 - 25:1	.4% - 4%	.51 - 5.1	.09 - 11	Car wash cleaning agents & detergents
\$460.68	MR1405M	2.9 - 120	100:1 - 20:1	1% - 5%	1.28 - 6.4	.5 - 14	Car wash applications including Hydrofluoric acids, tire cleaners, chlorine

California Proposition 65

ACCESSORIES



PRICE	PART #	DESCRIPTION	FOR MODEL
\$18.76	MR57111	Tip Kit	570CW, 571CW, 570CL, 571CL
\$35.54	MR50411	200 Mesh Strainer (80 Micron)	All Models
\$33.97	MR36000000031	Lip Seal & Piston Kit 4%	572, 573 Old Style/ for 500 series
\$54.09	MR57UFR	Low Flow Booster	-
\$35.54	MR50411	3/4" Female Strainer	500 Series
\$31.91	MR36073008002	Anti-Siphon Kit	500 Series

California Proposition 65

PROPORTIONAL INJECTORS & PARTS



ADJUSTABLE WATER DRIVEN PUMP

HYDRO SYSTEMS



The HydroMinder WDP (Water Drive Pump) is an advanced chemical dosing pump, with adjustable dilution rates. High dosing accuracy and repeatability for constant, precise chemical delivery. Highly engineered wet parts are constructed of materials with extremely high chemical resistance to alkaline chemicals including (but not limited to) hydroxides and phosphates as well as acids including (but not limited to) sulfuric, phosphoric, citric and hydrochloric acids. Consult Hydro Systems for any additional information on chemical compatibility as required.

Mounting versatility allows for water flow in both directions providing better installation versatility

Lasts up to 62 million cycles

Improved dilution accuracy across all flow rates reduces the risk of improper chemical dispensing that could result in vehicles needing rewash

Features fewer parts and tool-free maintenance resulting in up to 50% reduction in maintenance time compared to other technologies

SPECIFICATIONS:

AVERAGE DOSING ACCURACY: +/- 5% of selected ratio

FLUID MINIMUM TEMPERATURE: 34°F (1° C)

FLUID MAXIMUM TEMPERATURE: 100°F (38° C)

USE FOR:

- Pre-soak
- Special chemical applications
- Wax/protectants/rinse aids
- Detergent
- Tire care

PRICE	PART #	MODEL	FLOW RATE	INJECTION RANGE	PSI
CALL	IN117947	2% Adjustable	0.02 GPM - 11 GPM	1:500 (0.2%) - 1:50 (2%)	5 - 90
CALL	IN117948	5% Adjustable	0.02 GPM - 11 GPM	1:128 (0.8) - 1:20 (5%)	5 - 90

ADJUSTABLE WATER DRIVEN PUMP PARTS

HYDRO SYSTEMS



PRICE	PART #	ITEM	DESCRIPTION
	IN017210		
	IN017220		
\$24.65	IN017210	Replacement Dosage Gasket Kit for WPD, 0.2 - 2%	Full dosage gasket kit for replacing a cracked, deteriorating, or missing dosage gasket in the HydroMinder WDP Adjustable Pump, 0.2 - 2%. OEM repair kit provides correct fit and performance without need for tweaks. OEM parts guarantee use of correct materials for increased longevity.
\$41.34	IN017220	Replacement Dosage Gasket Kit for WPD, 0.8 - 5%	Full dosage gasket kit for replacing a cracked, deteriorating, or missing dosage gasket in the HydroMinder WDP Adjustable Pump, 0.8 - 5%. OEM repair kit provides correct fit and performance without need for tweaks. OEM parts guarantee use of correct materials for increased longevity.
\$26.62	IN017211	Replacement Wear Kit for WPD, 0.2 - 2%	Wear kit for use in Hydro Systems HydroMinder WDP Adjustable Pump, 0.2 - 2%. Includes dosing gasket and shaft. OEM repair kit provides correct fit and performance without need for tweaks.
\$43.30	IN017221	Replacement Wear Kit for WPD, 0.8 - 5%	Wear kit for use in Hydro Systems HydroMinder WDP Adjustable Pump, 0.8 - 5%. Includes dosing gasket and shaft. OEM repair kit provides correct fit and performance without need for tweaks.
\$123.76	IN017213	Replacement Check Valve Kit for WPD, 0.2 - 2%	Check valve kit for use in Hydro Systems HydroMinder WDP Adjustable Pump, 0.2 - 2%. Includes suction tube fitting assembly composed of poppet, O-ring, spring, and fitting. OEM repair kit provides correct fit and performance without need for tweaks.
\$187.28	IN017223	Replacement Check Valve Kit for WPD, 0.8 - 5%	Check valve kit for use in Hydro Systems HydroMinder WDP Adjustable Pump, 0.8 - 5%. Includes suction tube fitting assembly composed of poppet, O-ring, spring, and fitting. OEM repair kit provides correct fit and performance without need for tweaks.
\$298.01	IN017214	Wear Parts Maintenance Kit for WPD, 0.2 - 2%	Wear parts maintenance kit for use in Hydro Systems HydroMinder WDP Adjustable Pump, 0.2 - 2%. Includes inner cylinder, shaft, and check valve. OEM repair kit provides correct fit and performance without need for tweaks.
\$300.54	IN017224	Wear Parts Maintenance Kit for WPD, 0.8 - 5%	Wear parts maintenance kit for use in Hydro Systems HydroMinder WDP Adjustable Pump, 0.8 - 5%. Includes inner cylinder, shaft, and check valve. OEM repair kit provides correct fit and performance without need for tweaks.
\$465.76	IN017216	Complete Lower End Kit for WPD, 0.2 - 2%	Complete lower end kit for use in Hydro Systems HydroMinder WDP Adjustable Pump, 0.2 - 2%. Includes all parts necessary to maintain and rebuild lower end. OEM repair kit provides correct fit and performance without need for tweaks.
\$467.76	IN017226	Complete Lower End Kit for WPD, 0.8 - 5%	Complete lower end kit for use in Hydro Systems HydroMinder WDP Adjustable Pump, 0.8 - 5%. Includes all parts necessary to maintain and rebuild lower end. OEM repair kit provides correct fit and performance without need for tweaks.
\$85.72	IN017200	Replacement Motor Piston Kit for WPD and AquaBlend Xtreme	Full motor piston assembly for replacing a burnt out assembly in Hydro Systems AquaBlend Xtreme and HydroMinder WDP. OEM repair kit provides correct fit and performance without need for tweaks.



SUPERDOS NON-ELECTRIC, FLUID DRIVEN PROPORTIONAL INJECTORS



- SuperDos operates without electricity to precisely inject liquid concentrates into a water supply line using fluid flow as the power source.
- SuperDos is designed with a patented internal mixing chamber that promotes homogeneous mixing, while segregating harsh chemicals from critical internal components. It comes in various models that easily satisfy the demands of your most challenging applications.
- Proprietary composite body for chemical compatibility and for mixing aggressive chemicals
- Built-in on/off switch (30 and 45 models only), which allows user to stop the injection – but not the system
- Separate internal mixing chamber to prevent chemical contact with motor piston – for longer life and uniform mixing
- Interchangeable lower ends with the ability to adjust ratios while in operation

SPECIFICATIONS:

- **HOUSING:** Proprietary engineered composite material
- **REPEATABILITY:** +/- 3% of Ratio
- **FLUID MINIMUM TEMPERATURE:** 34°F (1° C)
- **MAXIMUM VERTICAL SUCTION OF CONCENTRATE:** 3.6 m
- **AVERAGE DOSING ACCURACY:** +/- 5%
- **FLUID MAXIMUM TEMPERATURE:** 100°F (38° C)
- **SELF-PRIMING:** Yes
- **MAXIMUM HORIZONTAL SUCTION OF CONCENTRATE:** 15.0 m

PRICE	PART #	MODEL	FLOW RATE	INJECTION RANGE	PSI
CALL	DM113228	SuperDos20 - 0.3%	0.04-20.0 GPM	1:4000-1:333	5-100



MINIDOS WATER DRIVEN PROPORTIONAL INJECTOR



- MiniDos operates without electricity to precisely inject liquid concentrates into a water supply line using fluid flow as the power source. It is designed with a patented internal mixing chamber that promotes homogeneous mixing, while segregating harsh chemicals from critical internal components.
- MiniDos comes in various models that easily satisfy the demands of your most challenging applications.
- Proprietary composite body which exceeds PVDF for chemical compatibility and for mixing aggressive chemicals
- Built-in on/off switch which allows user to stop the injection, but not the system
- Separate internal mixing chamber helps prevent chemical contact with motor piston, for longer life and uniform mixing
- Highest standard operating pressure in the industry, minimizing pressure surge damage

SPECIFICATIONS:

- **HOUSING:** Proprietary engineered composite material
- **REPEATABILITY:** +/- 3% of Ratio
- **FLUID MINIMUM TEMPERATURE:** 34°F (1° C)
- **MAXIMUM VERTICAL SUCTION OF CONCENTRATE:** 3.6 m
- **AVERAGE DOSING ACCURACY:** +/- 15%
- **FLUID MAXIMUM TEMPERATURE:** 100°F (38° C)
- **SELF-PRIMING:** Yes
- **MAXIMUM HORIZONTAL SUCTION OF CONCENTRATE:** 15.0 m

PRICE	PART #	MODEL	FLOW RATE	INJECTION RANGE	PSI
CALL	DM112630	MiniDos12 - 1%	0.04-12.0 GPM	1:500-1:100	6-140
	DM112632	MiniDos12 - 2.5%	0.04-12.0 GPM	1:200-1:40	6-140



TWIST II CLEAN



HYDRO SYSTEMS

- Inline filter designed to remove organics, sand and sediment from your water supply
- Used to filter water before entering equipment
- Simple 1/4" turn operation
- Filter element flushes completely clean in less than 20 seconds
- No need to turn off water to clean (eliminates air in system)
- Rugged design installs indoors or outdoors
- Stainless steel filter element lasts for years
- Never buy filter cartridges again!

PRICE	PART #	FILTERS
CALL	DM017004	Twist II Clean 3/4" (140 Micron)
	DM017008	Twist II Clean 1" (140 Micron)



SUPERDOS NON-ELECTRIC FLUID INJECTOR

HYDRO SYSTEMS

- Injects liquid concentrates into a water supply line using fluid flow as the power source.
- Offers chemical compatibility
- Interchangeable lower ends
- Great for car wash applications, cleaning, descaling, disinfecting and decontamination, hydroponics, misting systems, agricultural applications, soaps and foams
- Work well with acids, oils, and pesticides

PRICE	PART #	MODEL	FLOW RATE	INJECTION RANGE	PSI
\$1,304.20	IN113215	SuperDos 45 - 5%	0.25-45.0 GPM	1:200-1:20	5-80

PROPORTIONERS



OPERATING PRINCIPLE



DOSA LOCK

DOSATRON BEST PRACTICES

WATER QUALITY: Install a 200 mesh or 80 micron filter on inlet side of the unit.

WATER PRESSURE: Install pressure regulator on inlet side of the Dosatron unit.

WATER TEMPERATURE: Maximum 104°F (40°C)

CHEMICAL PROPORTIONERS

DOSATRON

- The water-powered Dosatron provides accurate car wash chemical dispensing while cutting your cost-per-car, and the units automatically compensate for flow and pressure changes providing consistent, repeatable results.

THE NEW D40 SERIES OFFERS:

- Metal-free and simplified piston
- Viton seal and o-rings
- Polypropylene housings
- Easy-to-adjust ratio stem

PRICE	PART #	MANU. PART #	INJ. RANGE	FLOW UP TO	PSI
\$1,448.99	DOSD4008	D40MZ1000VFII	1:1000 to 1:100	2.2 - 40 GPM	4.3 - 116
\$665.32	DOSD1435	D14MZ1000VFDII	1:1000 to 1:100	0.05 - 14 GPM	4.3 - 85
\$466.24	DOSD1402	D14MZ2VFDII	500:1 - 50:1	0.05 - 14 GPM	4.3 - 85
\$764.35	DOSD1405	D14MZ5AFDII	200:1 - 20:1	0.05 - 14 GPM	4.3 - 85
\$791.54	DOSD1410	D14MZ10AFDII	100:1 - 10:1	0.05 - 14 GPM	7 - 85
\$678.23	DOSD1430	D14MZ3000VFDII	3000:1 - 333:1	0.05 - 14 GPM	4.3 - 85
\$1,161.14	DOSD4002	D40MZ2VFII	500:1 - 50:1	2.2 - 40 GPM	4.3 - 116
\$1,454.40	DOSD4003	D40MZ3000VFII	3000:1 - 500:1	2.2 - 40 GPM	4.35 - 116
\$1,819.11	DOSD4005	D40MZ5AFII	100:1 - 20:1	2.2 - 40 GPM	7.2 - 116

New!

SEAL KITS

DOSATRON

PRICE	PART #	MANU. PART#	DESCRIPTION
\$71.84	DOSK1000	PJDI116VF	Seal Kit for DOSD1402
\$81.44	DOSK1010	PJDI120HTAF	Seal Kit for DOSD1405
\$103.19	DOSK1020	PJDI122HTAF	Seal Kit for DOSD1410
\$60.13	DOSED251500	PJ118VF	Seal Kit for DOSD2515
\$166.07	DOSPJDI139VF	PJDI139VF	Seal Kit for DOSD1430
\$71.40	DOSED252	PJ093VF	Seal Kit for D25RE2

DOSA LOCK SECURITY DEVICE

DILUTION SOLUTIONS



- Easy-to-install lock out device.
- Protects unauthorized access to your injector.
- Fits most Dosatron units
- INCLUDES:** Dosa Lock, lock, & key | Replacement lock & key available

\$54.02 **DOS1000**

LOW PRESSURE PANEL SYSTEMS

4 BAY PANEL



6 BAY PANEL



MODULAR HIGH & LOW PRESSURE SELF-SERVE SYSTEMS

DOSATRON



- Easy-to-install, modular style chemical dispensing unit mounted on a 24" x 17" durable black, polypropylene wall panel
- 3/4" outlet for additional panel hookup | 3/8" poly elbow for delivery to bays
- Dispenser operates on only water flow - only solenoids require electricity
- Eliminates Venturi premix tanks - saves space and keeps your equipment room organized
- No need for air diaphragm pumps - less air compressor use
- Get rid of messy Venturi metering tips that clog

WHEN CALLING FOR QUOTE PLEASE INDICATE:

- **NUMBER OF BAYS**
- **REQUIRED SOLENOID VOLTAGE (24V OR 110V)**
- **ARE YOU GOING TO USE THE PANEL FOR FOAMING APPLICATIONS?**

* Indicates second solenoid manifold included for foaming applications requiring air

** Indicates single solenoid manifold for spray application not requiring air

PART #	MANU. PART #	INJ. RANGE	DESCRIPTION	TYPICAL USE
PS6A138-1-A	D14MZ2VFDII	500:1 to 50:1	1 Bay - Air*	Foam Brush
PS6A138-1-NA	D14MZ2VFDII	500:1 to 50:1	1 Bay - No Air**	Presoak, Wax
PS6A138-2-A	D14MZ2VFDII	500:1 to 50:1	2 Bay - Air*	Foam Brush
PS6A138-2-NA	D14MZ2VFDII	500:1 to 50:1	2 Bay - No Air**	Presoak, Wax
PS6A138-3-A	D14MZ2VFDII	500:1 to 50:1	3 Bay - Air	Foam Brush
PS6A138-3-NA	D14MZ2VFDII	500:1 to 50:1	3 Bay - No Air	Presoak, Wax
PS6A138-4-A	D14MZ2VFDII	500:1 to 50:1	4 Bay - Air	Foam Brush
PS6A138-4-NA	D14MZ2VFDII	500:1 to 50:1	4 Bay - No Air	Presoak, Wax
PS6A138-5-A	D14MZ2VFDII	500:1 to 50:1	5 Bay - Air	Foam Brush
PS6A138-5-NA	D14MZ2VFDII	500:1 to 50:1	5 Bay - No Air	Presoak, Wax
PS6A138-6-A	D14MZ2VFDII	500:1 to 50:1	6 Bay - Air	Foam Brush
PS6A138-6-NA	D14MZ2VFDII	500:1 to 50:1	6 Bay - No Air	Presoak, Wax
PS6A155-1-A	D14MZ10AFDII	100:1 to 10:1	1 Bay - Air	Wheel & Tire, Bug Remover
PS6A155-1-NA	D14MZ10AFDII	100:1 to 10:1	1 Bay - No Air	
PS6A155-2-A	D14MZ10AFDII	100:1 to 10:1	2 Bay - Air	
PS6A155-2-NA	D14MZ10AFDII	100:1 to 10:1	2 Bay - No Air	
PS6A155-3-A	D14MZ10AFDII	100:1 to 10:1	3 Bay - Air	
PS6A155-3-NA	D14MZ10AFDII	100:1 to 10:1	3 Bay - No Air	
PS6A155-4-A	D14MZ10AFDII	100:1 to 10:1	4 Bay - Air	
PS6A155-4-NA	D14MZ10AFDII	100:1 to 10:1	4 Bay - No Air	
PS6A155-5-A	D14MZ10AFDII	100:1 to 10:1	5 Bay - Air	
PS6A155-5-NA	D14MZ10AFDII	100:1 to 10:1	5 Bay - No Air	
PS6A155-6-A	D14MZ10AFDII	100:1 to 10:1	6 Bay - Air	Wax, Presoak
PS6A155-6-NA	D14MZ10AFDII	100:1 to 10:1	6 Bay - No Air	
PS6A177-1-A	D14MZ3000VFDII	3000:1 to 333:1	1 Bay - Air	
PS6A177-1-NA	D14MZ3000VFDII	3000:1 to 333:1	1 Bay - No Air	
PS6A177-2-A	D14MZ3000VFDII	3000:1 to 333:1	2 Bay - Air	
PS6A177-2-NA	D14MZ3000VFDII	3000:1 to 333:1	2 Bay - No Air	
PS6A177-3-A	D14MZ3000VFDII	3000:1 to 333:1	3 Bay - Air	
PS6A177-3-NA	D14MZ3000VFDII	3000:1 to 333:1	3 Bay - No Air	
PS6A177-4-A	D14MZ3000VFDII	3000:1 to 333:1	4 Bay - Air	
PS6A177-4-NA	D14MZ3000VFDII	3000:1 to 333:1	4 Bay - No Air	
PS6A177-5-A	D14MZ3000VFDII	3000:1 to 333:1	5 Bay - Air	
PS6A177-5-NA	D14MZ3000VFDII	3000:1 to 333:1	5 Bay - No Air	
PS6A177-6-A	D14MZ3000VFDII	3000:1 to 333:1	6 Bay - Air	
PS6A177-6-NA	D14MZ3000VFDII	3000:1 to 333:1	6 Bay - No Air	

MIXING FOR FOAM APPLICATION WITH AIR? CONSIDER PURCHASING A MIXING CHAMBER FOR BETTER BLENDING.



3/4" MIXING CHAMBER

DILUTION SOLUTIONS



- Enhance chemical blending with a mixing chamber. Excellent for low flow applications (like foam brush)
- Made from chemical resistant blue poly | capacity of 3250 mL (110 oz)
- Excellent for: Low volume requirements | Minute injection rates | Constant on/off applications

\$101.23 MC34-PP

JANITORIAL & LAUNDRY

LAUNDRY CARTS & ACCESSORIES

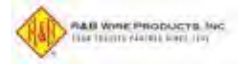

CAR WASH TOWEL CART WITH DURA-SEVEN™ ANTI-RUST COATING*

R&B WIRE PRODUCTS

- 2½ bushel capacity
- 26¾" L x 22" W x 11"D x 33½" H
- Durable foot locking caster prevents cart from rolling away

\$147.48 LD5010-D7 



STANDARD LAUNDRY CART WITH DURA-SEVEN™ ANTI-RUST COATING*

R&B WIRE PRODUCTS

- 2½ bushel capacity
- 26½" L x 22" W x 11" D x 27" H or 66½" H with pole
- Equipped with 5" Clean Wheel System™ casters
- Available in chrome and colored vinyl

\$112.81 LD5000-D7 Standard
\$190.86 LD5001-D7 With Single Pole Rack 

AVAILABLE WITH POLE!



Note:
4" Mega-Caster will not fit old style 3/4" square tubular carts.

4" GRAY MEGA-CASTER

R&B WIRE PRODUCTS

- Fits wire laundry carts from R&B Wire Products
- 2 mounting bolts and nuts included
- 4" diameter wheel crafted from gray polyurethane

\$15.21 LD5100 



5" GRAY MEGA-CASTER CLEAN WHEEL SYSTEM™ 4 PACK

R&B WIRE PRODUCTS

- Tapered polyurethane wheel creates less floor friction and less material build up on the wheel
- Dual sealed precision bearing for smooth rolling
- Fits wire laundry carts by R&B Wire Products

\$60.82 LD5105 



LARGE CAPACITY LAUNDRY CART WITH DURA-SEVEN™ ANTI-RUST COATING*

R&B WIRE PRODUCTS

- 4½ bushel capacity
- 33¾" L x 21½" W x 13¾" D x 30½" H
- Equipped with 5" Clean Wheel System™ casters
- Available in chrome and colored vinyl

\$147.21 LD5005-D7 



MEGA CAPACITY LAUNDRY CART WITH DURA-SEVEN™ ANTI-RUST COATING*

R&B WIRE PRODUCTS

- 6 bushel capacity
- 36½" L x 23" W x 16" D x 32½" H
- Equipped with 5" Clean Wheel System™ casters

\$228.30 LD5015-D7 



FRONT LOAD LAUNDRY CART WITH DURA-SEVEN™ ANTI-RUST COATING*

R&B WIRE PRODUCTS

- 2¼ bushel capacity
- 26½" L x 23" W x 14" D x 30" H (basket tapers to 7")
- Equipped with 5" Clean Wheel System™ casters

\$151.13 LD5100-D7 



MOBILE LAUNDRY SCALE W/POLY TUB

R&B WIRE PRODUCTS

- Holds 6 bushels of laundry
- 250 lb scale capacity
- Tub Interior Dimensions: 31" L x 16.50" W x 18.50" D

\$576.25 LD5510

*Dura-Seven™ anti-rust coating guarantees a minimum of 7 years without rust!

JANITORIAL & LAUNDRY

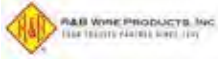

ACCESSORIES



METAL LAUNDRY HANGERS

- Measures 18" across
- Package of 250
- 10.5 gauge size

\$127.96 LD0100-11



POLISHED METAL HANGERS

- Measures 18" across
- Package of 500
- 14.5 gauge size

\$51.33 LD0100-60



NOTCHED HANGERS DRAPERY TUBES

- Measures 18" across
- Package of 250
- Used with metal hangers

\$76.64 LD0012



METAL STRUT HANGERS

- Measures 16" across
- Package of 500
- 14.5 gauge size

\$80.89 LD0100-21



GOLD COLOR METAL HANGERS

- Measures 16" across
- Package of 500
- 13 gauge size

\$56.10 LD0100-10



DRAWSTRING LAUNDRY BAG

- 20 Pack - each bag: 30" W x 40" H
- Nylon construction - assorted colors
- Drawstring design - foldable for simple vending

\$63.81 LD0050

New!



DURA-SEVEN™ LAUNDRY CART W/ DOUBLE POLE RACK

R&B WIRE PRODUCTS

- Includes two pole rack for hanging garments
- Maximum capacity of 2.5 bushels
- Equipped with 5" Clean Wheel System™ casters
- Product Weight: 41 lbs.
- 26.5" L x 22" W x 11" D x 66.5" H

APPLICATIONS:

- Humid environments & salty air

\$190.86 LD5002-D7



RACK EXTENDER FOR LD5115

R&B WIRE PRODUCTS

- Extends overall cart height to 90", well above a standard door opening
- Deters removal of cart from premises
- Chrome plated - no additional mounting hardware needed
- Available with or without warning sign (shown with)

\$61.90 LD5120 W/ WARNING SIGN
\$20.54 LD5125 W/O WARNING SIGN



SINGLE POLE RACK FOR LAUNDRY CARTS

R&B WIRE PRODUCTS

- Fits LD5000-D7, LD5005-D7, LD5015-D7, and LD5100-D7
- 17¾" pennant length
- Dura-Seven™ anti-rust coating

\$53.66 LD5110



DOUBLE POLE RACK FOR LAUNDRY CARTS

R&B WIRE PRODUCTS

- Fits LD500-D7 and LD5100-D7
- 23¾" cross bar
- Extends cart height to 65½"
- Dura-Seven™ anti-rust coating

\$53.66 LD5115



JANITORIAL & LAUNDRY

CARTS & CADDIES



New!



ELEVATED POLY LAUNDRY TRUCK

R&B WIRE PRODUCTS

- Best-in-class polyurethane tub with powder-coated tubular steel base and frame
 - Equipped with swiveling 5" Clean Wheel System™ casters
- 6 BUSHEL MODEL:**
- 200 lb. capacity
 - 31.5" L x 21.5" W x 21" D x 37.5" H
- 8 BUSHEL MODEL:**
- 250 lb. capacity
 - 35.75" L x 24.5" W x 40" H

6 BUSHEL MODELS ALL CASTERS SWIVEL		
\$244.53	LD5466-BL	Blue truck ●
	LD5466-BK	Black truck ●
	LD5466-GRY	Gray truck ●

8 BUSHEL MODELS ALL CASTERS SWIVEL		
\$292.76	LD5468-BL	Blue truck ●
	LD5468-BK	Black truck ●
	LD5468-GRY	Gray truck ●

New!



ELEVATED POLY BUMPER TRUCK

R&B WIRE PRODUCTS

- Equipped with non-marking air cushion bumpers to protect facilities and equipment
 - Equipped with swiveling 5" Clean Wheel System™ casters
- 6 BUSHEL MODEL:**
- 200 lb. capacity
 - 34" L x 23.75" W x 21" D x 37.5" H
- 8 BUSHEL MODEL:**
- 250 lb. capacity
 - 35.75" L x 24.5" W x 40" H

6 BUSHEL MODELS ALL CASTERS SWIVEL		
\$339.07	LD5466B-BL	Blue truck ●
	LD5466B-BK	Black truck ●
	LD5466B-GRY	Gray truck ●

8 BUSHEL MODELS ALL CASTERS SWIVEL		
\$389.87	LD5468B-BL	Blue truck ●
	LD5468B-BK	Black truck ●
	LD5468B-GRY	Gray truck ●

New!



STANDARD POLY TRUCK

R&B WIRE PRODUCTS

- Heavy duty polyurethane tub with a sturdy, powder-coated steel base
 - Industrial-grade swivel casters with non-marking wheels
- 8 BUSHEL MODEL:**
- 325 lb. capacity
 - Dimensions: 35.75" L x 24.5" W x 29.25" H
- 12 BUSHEL MODEL:**
- 425 lb. capacity
 - 38.25" L x 28" W x 35.75" H

8 BUSHEL MODELS ALL CASTERS SWIVEL		
\$299.29	LD4608-BL	Blue truck ●
	LD4608-BK	Black truck ●
	LD4608-GRY	Gray truck ●

12 BUSHEL MODELS ALL CASTERS SWIVEL		
\$333.35	LD4612-BL	Blue truck ●
	LD4612-BK	Black truck ●
	LD4612-GRY	Gray truck ●

New!



POLY BUMPER TRUCK

R&B WIRE PRODUCTS

- Equipped with non-marking air cushion bumpers to protect facilities and equipment
 - Heavy duty polyurethane tub with a sturdy, powder-coated steel base
- 8 BUSHEL MODEL:**
- 325 lb. capacity
 - Dimensions: 37.75" L x 26.5" W x 29.25" H
- 12 BUSHEL MODEL:**
- 425 lb. capacity
 - 41.25" L x 31" W x 35.75" H

8 BUSHEL MODELS ALL CASTERS SWIVEL		
\$388.65	LD5608-BL	Blue truck ●
	LD5608-BK	Black truck ●
	LD5608-GRY	Gray truck ●

12 BUSHEL MODELS ALL CASTERS SWIVEL		
\$434.76	LD5612-BL	Blue truck ●
	LD5612-BK	Black truck ●
	LD5612-GRY	Gray truck ●

JANITORIAL & LAUNDRY



ACCESSORIES

New!



4-BUSHEL ELEVATED LAUNDRY TRUCK

R&B WIRE PRODUCTS

- Features a durable vinyl liner that is mold, mildew, and tear resistant, as well as being fire retardant
- 5" Clean Wheel System™ casters
- Sits 16" off the floor
- Dimensions: 31.5" L x 20" W x 16" D x 32" H | 33" L x 21.5" W x 16.5" D x 32.5" H

31.5" LENGTH MODELS		
\$190.78	LD0464-BL	Blue truck ●
	LD0464-R	Red truck ●

33" MODELS FEATURING SEWN ON AIR CUSHION BUMPER		
\$250.76	LD0464S0-BL	Blue truck ●
	LD0464S0-R	Red truck ●

New!



6-BUSHEL ELEVATED LAUNDRY TRUCK

R&B WIRE PRODUCTS

- Features a durable vinyl liner that is mold, mildew, and tear resistant, as well as being fire retardant
- 5" Clean Wheel System™ casters
- Sits 12" off the floor
- Dimensions: 32" L x 21.5" W x 24" D x 36" H | 34" L x 23" W x 24.5" D x 36.5" H

32" LENGTH MODELS		
\$209.63	LD0466-BL	Blue truck ●
	LD0466-R	Red truck ●

34" MODELS FEATURING SEWN ON AIR CUSHION BUMPER		
\$273.69	LD0466S0-BL	Blue truck ●
	LD0466S0-R	Red truck ●

STANDARD VINYL BASKET TRUCK, PERMANENT LINER

R&B WIRE PRODUCTS

- Vinyl flame retardant liner with heavy-duty black rim for protection

8 BUSHEL MODEL:

- 8 bushel/300 lb. capacity
- 35" L x 23½" W x 30" H (height with 3" casters)

12 BUSHEL MODEL:

- 12 bushel/400 lb. capacity
- 38" L x 28" W x 36" H (height with 5" casters)

8 BUSHEL MODELS ALL CASTERS SWIVEL		
\$236.15	LD5220-1BL	Blue Truck ●
	LD5220-1R	Red Truck ●
2 SWIVEL 2 RIGID		
\$236.15	LD5220-2BL	Blue Truck ●
	LD5220-2R	Red Truck ●

12 BUSHEL MODELS ALL CASTERS SWIVEL		
\$272.44	LD5212-1B	Blue Truck ●
	LD5212-1R	Red Truck ●
2 SWIVEL 2 RIGID		
\$272.44	LD5212-2B	Blue Truck ●
	LD5212-2R	Red Truck ●



VINYL BUMPER TRUCK, 360 DEGREE PROTECTION, PERMANENT LINER

R&B WIRE PRODUCTS

- Non-marking air cushion bumper for additional protection along with a vinyl flame retardant liner

8 BUSHEL MODEL:

- 8 bushel/300 lb. capacity
- 36½" L x 25" W x 30½" H (height with 3" casters)

12 BUSHEL MODEL:

- 12 bushel/400 lb. capacity
- 38" L x 28" W x 36" H (height with 5" casters)

8 BUSHEL MODELS ALL CASTERS SWIVEL		
\$309.16	LD5225-1B	Blue Truck ●
	LD5225-1R	Red Truck ●
2 SWIVEL 2 RIGID		
\$309.16	LD5225-2B	Blue Truck ●
	LD5225-2R	Red Truck ●

12 BUSHEL MODELS ALL CASTERS SWIVEL		
\$355.56	LD5213-1B	Blue Truck ●
	LD5213-1R	Red Truck ●
2 SWIVEL 2 RIGID		
\$355.56	LD5213-2B	Blue Truck ●
	LD5213-2R	Red Truck ●



JANITORIAL & LAUNDRY

CARTS, WASTE RECEPTACLES & ACCESSORIES



3 LEVEL DETAILING CART
MEGUIAR'S



- 24" W x 18" D with a 400 lb. capacity
- Rounded corners will not scratch or mark surfaces
- 4" rubber, silent, full swivel wheels
- Engineered thermoplastic rain shelves
- Aluminum reinforced top shelf
- Resistant to acids, solvents, and petroleum-based products

\$172.64 MGCART MADE IN THE USA



COLLAPSIBLE X-CART
RUBBERMAID



- Durable, easy to maneuver basket truck efficiently transports bulk loads
- Stainless steel, powder coated frame for maximum rust protection and strength to support up to 220 lbs.
- Collapsible frame for efficient storage
- Multi-stream option provides the ability to easily divide and sort materials
- Wheel swivels provide quiet and simple movement with bumper guards for added safety and protection
- Color-coded ribbons classify transport materials to prevent cross-contamination

\$182.15 WR1881749 4 Bushel
\$208.94 WR1881750 8 Bushel



ALADDIN SELF-EXTINGUISHING SMOKERS POLE
RUBBERMAID



- Weather resistant and steel liner for easy disposal
- Oxygen reducing fluted design extinguishes cigarettes and is fire-safe
- Dimensions: 16" D X 38¾" H

\$240.35 WRR1639EHGR



SMOKER'S POLE
RUBBERMAID



- Its size reduces obstructions in high traffic areas
- Weather-resistant, fire-safe aluminum
- Features recessed extinguishing screen
- Dimensions: 12¾" W x 41" H

\$287.63 WRR1SM



GROUNDKEEPER® SMOKER'S STATION
RUBBERMAID



- Designed to handle all weather conditions with a resin construction
- Hygienic, easy-to-service steel canister
- Restricted opening shields waste from view, weather, and flow of oxygen
- Dimensions: 12¼" W x 39½" H

\$138.00 WR257088



NIFTYNABBER PRO HAND SQUEEZE TRASH GRABBER
UNGER

- Eliminates the need to bend over or stoop to pick up garbage off the ground
- Is squeezed with all fingers to greatly reduce hand fatigue
- Great tool for car washes, store lots, parks, highways, and other areas where trash collects
- 36" length | 4¼" grabber opening

\$45.62 NN900

JANITORIAL & LAUNDRY



WASTE RECEPTACLES & ACCESSORIES



BRUTE® 44 GALLON UTILITY CONTAINER RUBBERMAID

- Integrated cinches secure the liner, allowing for efficient knot free liner changes. Tested to 20,000 cycles.
- Rounded handles make lifting and moving easier, and are reinforced to resist tearing
- Reinforced base is specifically engineered to be dragged over rough surfaces
- Rim features integrated rib structure to increase strength and resist crushing
- Meets NSF 2.21 approval/USDA Meat and Poultry Group listed, ensuring regulatory compliance for food storage and cleanability
- Stackable design enables nesting for easy transport and storage

\$57.47 **WR264360G**



BRUTE® 44 GALLON DOME LID RUBBERMAID

- Snap-on features secure lid tightly onto compatible container
- Swinging door contains odors, water, and bugs out
- UV stabilizer for added durability
- Stackable for space-efficiency
- Resistant to rusting, chipping, peeling, and denting
- Food safe for use in storage or food prep areas

\$119.42 **WR264788G**



30/55 GALLON DRUM DOLLY JANITORIAL SUPPLIES

- Holds a 30 gallon or 55 gallon drum
- 900 lb. capacity
- 18¾" to 23¼"
- 5 casters
- Gray polypropylene

\$99.55 **DD3055**



BRUTE® 44 GALLON DOLLY RUBBERMAID

- Five rugged casters help keep fully loaded BRUTE Containers stable and swivel smoothly
- Structural foam construction provides superior strength and durability, with a 250-pound capacity
- Will work with 20,32, 44 and 55 containers
- Non-marking casters protect floors
- Use the twist lock feature to secure in place

\$78.72 **WR264000**



BRUTE® CADDY BAG RUBBERMAID

- Onboard storage for spray bottles, microfiber cloths, brushes, extra can liners, latex gloves, and other supplies
- Heavy-duty vinyl for long life
- Adjustable straps for easy installation and removal

\$41.03 **WR264200**



BRUTE® RIM CADDY RUBBERMAID

- Multiple storage compartments and hooks provide storage for a wide range of cleaning accessories
- Liner retention bands keep can liners securely in place and allow for quick liner changes
- Snap-on tabs hold caddy securely on a 44-gallon BRUTE Container, even when changing out full can liners

\$83.47 **WR9W8700**



41 QUART WASTEBASKET RUBBERMAID

- Fits under standard desk height even when swing top is fully extended
- All-plastic construction won't chip, rust or dent
- Gray Color

\$12.41 **WR295700G**



POLY CAN LINERS FORDION JANITORIAL SUPPLIES

- Natural color
- High density for maximum efficiency

PRICE	PART #	SIZE	MICRONS	CAPACITY	CASE QTY
\$15.25	WR610001	24" L x 24" W	6	7-10 Gal.	1,000
\$28.22	WR610002	60" L x 36" W	12	55 Gal.	200

DON'T FORGET TO ORDER CAN LINERS! Available in capacities ranging from 7 gallons to 55 gallons!

JANITORIAL & LAUNDRY

FIRST AID & DISPENSERS



EACH GROUP KIT WILL VARY
IN QUANTITY AND PRODUCTS

FIRST AID KIT

CCP INDUSTRIES

INCLUDES:

- 10 PW - Empty poly box
- Certi-Strips - Plastic
- Certi-Gauze Pads
- Certi-Sporyn-Antibiotic cream
- Antiseptic BZK towelettes
- Burn cream
- Triangular bandage
- Trauma pad
- Certi-Strips - Heavy weight woven fingertip and knuckle
- Certi-Pad
- Gloves
- Certi-Tape
- Ammonia inhalant ampoule size
- PVP Iodine wipe-ups
- First Aid facts guide card
- Safety Flag Seal

\$23.69	SKBU43	For groups of 10
\$51.10	SKBU44	For groups of 25
\$73.50	SKBU45	For groups of 50



HYDRO SYSTEMS SPRITE TL-400 DISPENSER WITH TWO PUMPS DISPENSERS

- Ensure the accurate amount of chemical is automatically added to every load
- Users can select from four different programmable formulas for varying soil loads
- Operates manually or by electronic activation & features a programmable "double dose" lockout
- Three modes of operation with stopwatch style programming and a built-in load counter
- Pre-wired and password protected

\$511.71 **IN00-08511-420**



TAURUS CP-300 PUMP DISPENSER DISPENSERS

- Fully programmable single pump dispenser designed for use on top load laundry applications as well as any application requiring a single product to be dosed with extreme accuracy
- Lockout is protected against power interruptions; the lockout period resumes where it left off once power is restored
- Universal power supply makes it the right choice regardless of where in the world you are located

\$301.25 **IN00-08879-00**

TOWEL EMULSIFIERS & SANITIZING



TOWELS BY DOCTOR JOE® PRIME EMULSIFIER MICROFIBER TOWEL CLEANER

LAUNDRY PRODUCTS



- Gentle cleanser that not only removes oils and dirt from your microfiber towels, but improves their absorbency, too! When used regularly, Dr. Joe's formula opens the pores in towel fibers, allowing more water retention during use, and allowing the release of dirt, oil, and grease during wash cycles.
- Safe for all fabrics including microfiber and cotton
- Removes oil, dirt, and grease
- Opens towel fibers to promote better absorption
- No effect on wastewater pH

PRIME EMULSIFIER - REGULAR			PRIME EMULSIFIER - PREMIUM		
DILUTION: 2 OZ. PER LOAD			DILUTION: 1.5 OZ. PER LOAD		
\$99.62	DJMFC02-5	5 Gallon	\$1,208.08	DJMFC03-55	55 Gallon
\$792.41	DJMFC02-55	55 Gallon			



INTERIOR VEHICLE SANITIZING KIT

KLEEN-RITE



- Sanitize and disinfect the interiors of customer vehicles, as a courtesy or as an additional service.
- The Dema 900.5LSU Foam Spray Unit is a super-compact chemical sprayer with a manual hand pump.
- Simoniz Proselect RTU Interior Car Surface Disinfectant, Sanitizer and Deodorizer sanitizes and disinfects against many of the leading bacteria, viruses, and fungus found in vehicles. For use on soft vehicle surfaces including upholstery, fabric, and seat cushions, as well as household surfaces including couches and blankets. Appropriate for hard, nonporous vehicle surfaces including dashboards, steering wheels, windows, doors, instrument panels, consoles, seat belt buckles, and almost any metal, stainless steel, or plastic surface.
- **INCLUDES:** 1 Dema 900.5LSU Pump Spray Unit • 1 Case (12 quarts) Simoniz RTU Interior Sanitizer

CALL **KRK9000**

JANITORIAL & LAUNDRY



SIMONIZ® ELIMINATORS, BULK POWDERED DETERGENTS & MORE



SIMONIZ® ELIMINATOR LAUNDRY PRODUCTS

- 1 gallon; A heavy duty deodorant for use anywhere odor is a big issue

SPECIFICATIONS:

- Color: Transparent • Form: Liquid • Scent: Fresh Floral
- pH: 6.0 • Flash Point: None • Foam: Low • Viscosity: Water Thin
- Biodegradable formula

DILUTION:

- Light: 1/256 (1/2 oz. / gal) • Medium: 1/128 (1 oz. / gal)
- Heavy: 1/64 (2 oz. / gal)

\$14.80 JS2107004



ANTIMICROBIAL ALL-PURPOSE CLEANER SIMONIZ

- A RTU, quaternary-based nonacid cleaner and disinfectant, this cleaner can be used on the following nonporous, inanimate surfaces: walls, shower stalls, bathroom tile, toilet bowls, counter tops, and more.

\$15.75	JS2635	1 Gallon
\$50.54	JS2635-12	1 Quart - 12 Quarts/Case

Non-cancellable & non-returnable - all sales final



BLUE LABEL LAUNDRY POWDERED DETERGENTS

- 50 lb. box
- **DILUTION:** ¼ - ½ cup

\$55.36 BX5111



CLOTHESLINE FRESH POWDERED DETERGENTS

- 50 lb. box
- **DILUTION:** 2 cups/100 lbs.

\$46.76 BX5114



DAILY ECONOMICAL POWDERED DETERGENTS

- 50 lb. box
- **DILUTION:** 2 cup/100 lbs.

\$48.62 BX5116



SUPER BLUE POWDERED DETERGENTS

- 50 lb. box
- **DILUTION:** 2½ cup/100 lbs.

CALL BX5112



RED LABEL LAUNDRY POWDERED DETERGENTS

- 50 lb. box
- **DILUTION:** ½ - 1 cup

\$48.61 BX5117



GREEN SCENE H.E. LAUNDRY POWDER POWDERED DETERGENTS

- 50 lb. box
- **DILUTION:** 1½-3 TBSP/3 gals.
- Lemon fresh scent

\$103.85 BX5110



ULTRA DAILY BLEACH POWDERED DETERGENTS

- 50 lb. box
- **DILUTION:** 1/3 per load
- Lemon scented

\$53.09 BX5119



RTU CAR SURFACE SANITIZER & DISINFECTANT SIMONIZ

- Sanitizer and disinfectant for both hard and soft vehicle interior surfaces. Ready-to-use formulation means no dosing or measuring.
- This is an EPA-registered product qualified for use against SARS-CoV-2, the novel coronavirus that causes COVID-19.

\$112.32	PA5537	5 Gallons
\$47.64	JS202600	1 Quart - 12 Quarts/Case



BULK LIQUID DETERGENTS & SOFTENERS



LIQUID LAUNDRY DETERGENT WITH BRIGHTENERS LIQUID DETERGENTS

- **DILUTION:** as needed • ½ cup - 1 cup

\$55.87	PA5286	5 Gal
\$563.69	DR55286	55 Gal



GREEN SCENE H.E. LAUNDRY DETERGENT LIQUID DETERGENTS

- 5 gallon pail
- **DILUTION:** 3 to 6 oz. / 3 gal.
- Lemon fresh scent

\$62.94 PA5281



WASH PLUS ECONOMICAL LIQUID DETERGENT LIQUID DETERGENTS

- 5 gallon pail
- 1 cup/25 lbs.

\$37.70 PA5289



FLUFFY FABRIC SOFTENER LIQUID DETERGENTS

- 2 oz./final rinse - 4 single gallons per case

\$42.30 GL1165

JANITORIAL & LAUNDRY

LAUNDRY RETAIL PRODUCTS



TIDE® 2X LIQUID

LAUNDRY RETAIL - PROCTER & GAMBLE

- Cleans & removes stains
- Phosphate-free - biodegradable soap
- Safe for septic systems
- Recyclable packaging

PRICE	PART #	SIZE	LOADS	CASE QTY
\$39.11	LD3300-6	10 oz.	6	12
\$38.16	LD3300-16	25 oz.	16	6
\$66.53	LD3300-32	50 oz.	32	6



TIDE® 2X LIQUID WITH BLEACH ALTERNATIVE

LAUNDRY RETAIL - PROCTER & GAMBLE

- Original liquid formula with bleach alternative
- Cleans, freshens, whitens, and brightens
- Original scent

PRICE	PART #	SIZE	LOADS	CASE QTY
\$40.67	LD3302-13	25 oz.	13	6



GAIN® 2X LIQUID

LAUNDRY RETAIL - PROCTER & GAMBLE

- A combination of fragrances to keep your customers coming back for fresh, clean clothing!

PRICE	PART #	SIZE	LOADS	CASE QTY
\$31.93	LD3306-6	10 oz.	6	12
\$33.27	LD3306-16	25 oz.	16	6
\$50.35	LD3306-32	46 oz.	32	6



ARES HE LIQUID LAUNDRY DETERGENT

LAUNDRY RETAIL - ARES

- Suitable for use in high-efficiency front loading washers or conventional top loading washers
- Safe for use in any temperature water

PRICE	PART #	SIZE	LOADS	CASE QTY
\$43.02	LD3310	18 oz.	6	16



CLOROX LIQUID BLEACH

LAUNDRY RETAIL - CLOROX



- Removes tough stains while whitening, disinfecting, and deodorizing surfaces and clothing

PRICE	PART #	SIZE	LOADS	CASE QTY
\$43.35	LD3316	24 oz.	8	12



DOWNY® APRIL FRESH® LIQUID FABRIC SOFTENER

LAUNDRY RETAIL - PROCTER & GAMBLE

- Rinse-added fabric softener provides amazing fabric care that softens, reduces static cling, and leaves clothing and linens smelling great

PRICE	PART #	SIZE	LOADS	CASE QTY
\$16.96	LD3318-12	10 oz.	12	12
\$22.33	LD3318-23	19 oz.	23	6



CLEAN SCENTSACTIONS™ TROPICAL PARADISE™ FABRIC SOFTENER SHEETS

LAUNDRY RETAIL - ARM & HAMMER

- 20 sheets per box
- Softens clothes while reducing static cling

PRICE	PART #	CASE QTY
\$18.82	LD3326-20	12



SUAVITEL® FIELD FLOWERS® SCENTED LIQUID FABRIC SOFTENER

LAUNDRY RETAIL - COLGATE PALMOLIVE

- Bright and airy, fresh fragrance
- Leaves clothing feeling soft and fresh

PRICE	PART #	SIZE	CASE QTY
\$19.92	LD3320-15	15.2 oz.	12
\$34.60	LD3320-33	28.7 oz.	12



SUAVITEL® FIELD FLOWERS® SCENTED FABRIC SOFTENER SHEETS

LAUNDRY RETAIL - COLGATE PALMOLIVE

- 70 sheets per box
- Softens clothing while cutting down on static cling
- Makes ironing easy

PRICE	PART #	CASE QTY
\$21.51	LD3328	6

JANITORIAL & LAUNDRY

LAUNDRY VENDING PRODUCTS



TIDE DETERGENT

- Powder, 156 per case

\$88.69 LD1000



TIDE WITH BLEACH

- Powder, 156 per case

\$88.69 LD1050



CLOROX 2

- 154 per case

\$66.08 LD1200



OXI CLEAN

- 1 oz., 156 per case

\$79.39 LD1500



DISOL-VOL STAIN REMOVER

- 100 per case

\$51.45 LD2800



BOUNCE FABRIC SOFTENER DRYER SHEETS

- 15 sheets per box • 15 per case

\$18.34 LD3322-15



BOUNCE DRYER SHEETS

- 2 Pack, 156 per case

\$88.69 LD1100



SNUGGLE DRYER SHEETS

- 2 Pack, 100 per case

\$34.25 LD1700



SNUGGLE SOFTENER

- Liquid, 100 per case

\$48.88 LD2100



DOWNY FABRIC SOFTENER

- Liquid, 156 per case

\$88.69 LD1300

New!



DOWNY UNSTOPPABLES IN-WASH SCENT BOOSTER

- 1.37oz beads per pack, 156 per case

\$83.78 LD3210



CLOROX BLEACH

- Liquid, 54 per case

\$26.89 LD1400



GAIN DETERGENT

- Powder, 156 per case

\$88.69 LD1800



ALL STAIN LIFTER DETERGENT

- Powder, 100 per case

\$56.19 LD2900



ALL FREE & CLEAR DUAL PACK

- Detergent/dryer sheets - 100 per case

\$64.00 LD3200



ALL FREE & CLEAR DRYER SHEETS

- 2 pack, 100 per case

\$34.55 LD3100



ALL FREE & CLEAR LIQUID

- Liquid, 100 per case

\$49.93 LD3000



50¢ VENDRITE BAGS

- 144 bags per case
- Plastic - 1 per box
- Fits in soap vendor

\$49.63 LD2500



50¢ VENDRITE BAGS

- 144 bags per case
- Plastic - 1 per box
- Fits in bag vendor

\$49.31 LD2400



75¢ VENDRITE BAGS

- 120 bags per case
- Plastic - 1 per box
- Fits in bag vendor

\$64.19 LD2600



50¢ LAUNDROSAK®

- 154 bags per case
- Plastic - 1 per box
- Fits in soap vendor

\$68.67 LD2200



50¢ LAUNDROSAK®

- 154 bags per case
- Plastic - 1 per box
- Fits in bag vendor

\$68.67 LD2300



75¢ SUPERSAK®

- 126 bags per case
- Plastic - 1 per box
- Fits in bag vendor

\$80.31 LD2700

JANITORIAL & LAUNDRY

LAUNDRY VENDING



3 COLUMN LAUNDRAMAX VENDING MACHINE

LAUNDRY VENDING

- Soap box vending machine
- Digi-Max Display Included
- Transformer required, sold separately
- Slugbuster Coin Acceptor
- 24V AC power required

\$1,624.13	VEL899LMAX	With Slugbuster
\$2,017.27	VEL899LMAXC	With Slugbuster, & CryptoPay swiper
\$1,705.27	VEL899LMAX-MA	Soap Box Vending Machine w/ MA850
\$2,097.05	VEL899LMAX-MAC	With MA850, & CryptoPay swiper
FREE	VE0133	3 column decal

SHOWN WITH OPTIONAL SWIPER



CRYPTOPAY WIRELESS CREDIT CARD SYSTEM FOR LAUNDRY

- Reduces fees and secures your transactions.
- The MyCryptoPay Online Program allows you to view recent purchases, configure your CryptoPay Swipers, and ensure your system is up and running remotely from your computer or mobile device.
- The CryptoPay Coordinator unit wirelessly and securely transmits to each of the CryptoPay Swipers. The Coordinator connects to the internet and authorizes and finalizes transactions, and is used to remotely re-configure the swipers. One coordinator is needed per wash location and supports many Swipers.
- The CryptoPay Wireless Swiper encrypts credit card data at the moment of credit card swipe and securely transmits the encrypted data. Encrypted data can only be decrypted by the Magensa Protected Payment Gateway. The Magensa Protected Payment Gateway is PCI-DSS certified and listed by MasterCard and Visa as a compliant service provider.
- Simple design that is easy to install.

\$374.99	CPS3000	CryptoPay Coordinator
\$424.99	CPS3005-25	Laundry Swiper with Power Adapter
\$6.50	CPS3010	Cat 5 Ethernet Cable



MEGA-VENDOR® III REFRIGERATED WITH COINCO

RAIN TUNNEL LAUNDRY VENDING

MEGA-VENDOR III



- 39" W x 35" D x 72" H
- Glass front vending machine available in two different configurations: 6 product trays, or 4 product trays with 2 drink trays
- The machine will vend 41 to 56 items depending on product size.
- Mega-Vendor™ III is rated for outdoor use and cools to 40°F
- Built in security features including: Heavy gauge steel lock cover, triple pane heated glass protected by a polycarbonate panel, steel vandal panels, and a steel keypad cover built in. These features combine to enable use without a security enclosure

\$8,853.00	MG90040-C	WITH Drink Trays
\$8,853.00	MG90030-C	WITHOUT Drink Trays



MEGA-VENDOR® II WITH COINCO

RAIN TUNNEL LAUNDRY VENDING

MEGA-VENDOR II

- 39" W x 72" H x 35" D • 41-51 Selection
- 6 shelf combination drink, snack and product vendor
- Will vend 41-51 items depending on the size of each product
- The MegaVendor II has a ½ HP compressor, triple pane heated glass to reduce condensation.
- Equipped with Coinco Vantage Bill Acceptor and a Coinco Coin Validator – which can be programmed to accept tokens

\$7,962.00 **MG90020-C**



MEGA-VENDOR® I WITH COINCO

RAIN TUNNEL LAUNDRY VENDING

MEGA-VENDOR I

- 45-55 Selection Dimensions - 39" W x 35" D x 72" H
- 39 Selection Dimensions - 35" W x 35" D x 72" H
- Will vend up to 45-55 items depending on the size of each product.
- Coinco Bill Acceptor \$1, \$5, \$10, \$20 & coin validator are standard
- Can be programmed to accept tokens
- Free standing & flush mount security systems available

\$6,325.00	MG90000-C	Non-Refrigerated
\$6,738.00	MG90010-C	Refrigerated

CryptoPay offers the most secure and cost effective choice for adding credit card acceptance at your laundry.



YOUR ONE-STOP SHOP FOR COMMERCIAL LAUNDRY & MORE!

Kleen-Rite carries commercial laundry carts, hampers, vending products, and equipment at unbeatable prices!

JANITORIAL & LAUNDRY

GREENWALD



25¢ VERTICAL 8 CHUTE
GREENWALD

\$51.67 GR20-1000-1



75¢ VERTICAL 8 CHUTE
GREENWALD

\$51.67 GR20-1000-3



\$1.25 VERTICAL 5 CHUTE
GREENWALD

\$47.05 GR27-125



SHORT SHANK KEY
GREENWALD

\$27.71 GR8-1169



SPECIAL ULTRA GUARD MONEY BOX
5⁵/₈" L x 3³/₄" W x 2¹/₂" H
GREENWALD

\$27.63 GR8-1210



SPECIAL ULTRA GUARD MONEY BOX
5⁵/₈" L x 3³/₄" W x 2¹/₂" H
GREENWALD

\$35.96 GR8-1275-0

MORE SLIDES AND PARTS AVAILABLE AT KLEENRITE.COM IN OUR NEW LAUNDRY & JANITORIAL SECTION!

COIN/TOKEN COUNTERS



COMPACT COIN COUNTER U.S. COIN & TOKENS
AMERICAN CHANGER



- Full batching capabilities
- Programmable bag stops
- Counts 1800 PPM
- Continuous or preset counting modes
- Hopper capacity of 1500 coins

CALL AMC301



MODEL
CE SHOWN

MULTIPLE COIN COUNTER, WRAPPER & BAGGER
KLOPP INTERNATIONAL, INC.



- Great for counting WET coins and tokens
- Made of cast aluminum and hardened steel
- Counts, wraps and/or bags US coins & 5 token sizes
- Wraps \$1,000.00 in quarters in just 20 minutes!
- Processes 1,400 quarters per minute (CE), 1,200 quarters per minute (CM)
- Machines include (3) Nylon wrapping tubes of your choice (Quarter, Dime, Nickel) OR (1) Nylon wrapping tube and (1) all-purpose bagging tube

\$1,229.27	CB1000	Model CM - Manually Operated
\$1,664.63	CB1010	Model CE - Electrically Operated
\$35.90	CB1020	Universal Bagging Tube



MODEL
CMB
SHOWN

SINGLE COIN COUNTERS/BAGGERS
KLOPP INTERNATIONAL, INC.



- Great for counting WET coins and tokens
- Same heavy-duty construction in our Model CM and Model CE.
- Bags (1) type of coin only. You specify which coin. Machine does not wrap.
- Machines will count into a bagging tube. Great for bank deposits or re-circulating coins back into your bill changers.
- Processes 1,200 quarters/per min. (CMB)
- Comes equipped with (1) all purpose bagging tube

\$998.78 CB1025 Model CMB - Manually Operated

JANITORIAL & LAUNDRY

CHANGERS & BILL BREAKERS



AMC7815 REAR LOAD MULTI-BILL CHANGER AMERICAN CHANGER



- High security multi-bill changer

DISPENSER CAPACITY	Dual 700-Note Cartridges
ACCEPTS	\$1, \$5, \$10, \$20
STACKER CAPACITY	500 Bills
STANDARD MODEL	AMC7815
OPTIONAL VALIDATOR	AMC7815-M CPI/MEI Validators

CALL FOR PRICING



AMC1002 HIGH SECURITY FRONT LOAD CHANGER AMERICAN CHANGER



HOPPER CAPACITY	2,600 Qrt/Tkn or 1,600 \$1 Coins	
ACCEPTS	\$1, \$5, \$10, \$20	
DIMENSIONS	10½" W x 26" H x 13" D	
STANDARD MODEL	AMC1002	Pyramid Validator
OPTIONAL VALIDATORS	AMC1002-M	CPI/MEI Validators

CALL FOR PRICING



AMC2225 REAR LOAD CHANGER AMERICAN CHANGER



- High security multi-bill changer

HOPPER CAPACITY	QTRS/TKNS - 5,600/hopper (11,200 total)
	\$1 COINS - 4,440/hopper (8,800 total)
ACCEPTS	\$1, \$5, \$10, \$20
STACKER CAPACITY	1,000 Bills
STANDARD MODEL	AMC2225
OPTIONAL VALIDATORS	AMC2225-M CPI Validators

CALL FOR PRICING



AMC7715 REAR LOAD BILL TO BILL DISPENSER AMERICAN CHANGER



- High security single bill dispenser

DISPENSER CAPACITY	Single 700-Note Cartridge	
ACCEPTS	\$1, \$5, \$10, \$20	
STACKER CAPACITY	500 Bills	
STANDARD MODEL	AMC7715	
OPTIONAL VALIDATORS	AMC7715-M	CPI Validators

CALL FOR PRICING



TRIAD BILL BREAKER SERIES TRIAD BILL CHANGERS & BREAKERS



INCOMING BILLS:

- CPI Talos \$1, \$5, \$10, \$20 bill acceptor with 4-way acceptance direction

OUTGOING BILLS:

- Fujitsu F53 bill dispenser - 2, 3 or 4 denominations
- Bill cassette capacities:
- Cassette holds 500 new bills each

OUTGOING COINS/TOKENS:

- Coin hopper capacity: 2600 quarters/tokens (\$650)

CABINET DIMENSIONS:

- 38.62" H x 12.06" W x 18" D
- 160 lbs (500RL-2)
- 170 lbs (500RLC1-2)

FACE PLATE DIMENSIONS:

- 43"H x 18"W

POWER:

- 120 VAC, 60 Hz, 230W/3.5A

TC500A-FL SERIES FRONT LOAD OPTIONS AVAILABLE!

KR PART #	FEATURES
TC500A-RL2	2 Bill Denominations
TC500A-RLC1-2	2 Bill Denominations with 1 hopper
TC500A-RL3	3 Bill Denominations
TC500A-RL4	4 Bill Denominations



BC-1600A WITH 2 MARS VALIDATOR AND 2 HOPPERS ROWE



- Updated to have American Changer components!
- Rear load
- Remote access board allows machine monitoring via a secure webpage
- 2 CPI bill acceptors take \$1, \$5, \$10 and \$20 bills
- 2 stackers hold 500 bills each (1,000 bills total)
- 2 hoppers hold 12,300 quarters total (or 9,650 \$1 coins)
- 12.06" W x 38.62" H x 18.25" D in stainless steel
- Faceplate: 18 W x 43 H in

RC1600RL-00



We have a wide variety of changer and bill breaker options to fit the needs of your business. See the **CHANGERS & COUNTERS** section of this catalog or visit the laundry section of the Kleen-Rite website for more options!

JANITORIAL & LAUNDRY

CHANGERS & BILL BREAKERS



**MODEL ER-60
ECONOMY REAR LOAD**
HAMILTON CHANGERS

HAMILTON

HOPPER CAPACITY	\$600 in quarters	
CHANGES/PAYS	\$1, \$5, \$10, \$20	
XE VALIDATOR	HC060	\$2,759.91
COINCO VALIDATOR	HC060-C	\$2,575.62
MARS VALIDATOR	HC060-M	\$2,759.92



**MODEL 1200FL-S
FRONT LOAD VERSATILITY**
HAMILTON CHANGERS

HAMILTON

HOPPER CAPACITY	\$1,200 in quarters	
CHANGES/PAYS	\$1, \$5, \$10, \$20	
STANDARD MODEL	HC065	\$3,210.20
MARS VALIDATOR	HC065-M	\$3,210.20



**MODEL RNS
REAR LOAD**
HAMILTON CHANGERS

HAMILTON

HOPPER CAPACITY	\$1,200 in quarters	
CHANGES/PAYS	\$1, \$5, \$10, \$20	
STANDARD MODEL	HC075	\$3,294.79
COINCO VALIDATOR	HC075-C	\$3,125.61
MARS VALIDATOR	HC075-M	\$3,294.79



**MODEL DRS
DUAL REAR LOAD**
HAMILTON CHANGERS

HAMILTON

HOPPER CAPACITY	\$2,400 in quarters	
CHANGES/PAYS	\$1, \$5, \$10, \$20	
STANDARD MODEL	HC077	\$5,663.25
COINCO VALIDATOR	HC077-C	\$5,324.89
MARS VALIDATOR	HC077-M	\$5,663.25



**MC300RL REAR LOAD
MODULAR SERIES**
STANDARD CHANGER MAKERS, INC.



HOPPER CAPACITY	\$800	
CHANGES/PAYS	\$1, \$5, \$10, \$20	
ACCEPTOR	Pyramid Technologies	

\$2,766.67 DC300RL

NEW K5000 HOPPER!



**MC520RL-DA REAR LOAD
MODULAR SERIES**
STANDARD CHANGER MAKERS, INC.



HOPPER CAPACITY	2 hoppers totaling \$1,600	
CHANGES/PAYS	\$1, \$5, \$10, \$20	
ACCEPTOR	Dual Pyramid Technologies	

\$4,862.50 DC520RL-DA

NEW K5000 HOPPER!



MC600RL REAR LOAD
STANDARD CHANGER MAKERS, INC.



- Dual bill validators with expanded function module

PRICE	PART #	HOPPERS	CAPACITY
\$8,104.17	DC620RL-DA	2	18,000 Qtrs
\$9,033.33	DC640RL-DA	4	12,800 Qtrs

NEW K5000 HOPPER!

CONVERT YOUR 500/600 SYSTEM TO CPI TALOS!

SC CONVERSION KITS - US CURRENCY



CONVERSION KITS

- Converts systems 500, 500-E & 600 to CPI Talos Bill Acceptors

\$1,920.94 DCP4K01328-FI CPI Talos Conversion Kit

JANITORIAL & LAUNDRY

INSTRUCTIONAL & SAFETY SIGNAGE



CHILDREN/CARTS WARNING
KLEEN-RITE LAUNDRY SIGNS

• 10" x 12" • PVC construction

\$12.50 SIKRL100



EQUIPMENT FAILURE
KLEEN-RITE LAUNDRY SIGNS

• 10" x 12" • PVC construction

\$12.50 SIKRL101



NO SMOKING
KLEEN-RITE LAUNDRY SIGNS

• 10" x 12" • PVC construction

\$12.50 SIKRL102



DO NOT SIT ON
KLEEN-RITE LAUNDRY SIGNS

• 10" x 12" • PVC construction

\$12.50 SIKRL103



LAST WASH
KLEEN-RITE LAUNDRY SIGNS

• 10" x 12" • PVC construction

\$12.50 SIKRL104



EMPTY POCKETS
KLEEN-RITE LAUNDRY SIGNS

• 10" x 12" • PVC construction

\$12.50 SIKRL105



PLEASE CHECK WASHERS
KLEEN-RITE LAUNDRY SIGNS

• 10" x 16" • PVC construction

\$13.93 SIKRL200



NEAT AND CLEAN
KLEEN-RITE LAUNDRY SIGNS

• 10" x 16" • PVC construction

\$13.93 SIKRL201



DO NOT OVERLOAD
KLEEN-RITE LAUNDRY SIGNS

• 12" x 16" • PVC construction

\$16.43 SIKRL300



THANK YOU WITH SMILEY
KLEEN-RITE LAUNDRY SIGNS

• 12" x 16" • PVC construction

\$16.43 SIKRL301



KEEPING CLEAN
KLEEN-RITE LAUNDRY SIGNS

• 12" x 16" • PVC construction

\$16.43 SIKRL302



LAST WASH WITH MOON
KLEEN-RITE LAUNDRY SIGNS

• 12" x 16" • PVC construction

\$16.43 SIKRL303



REMOVE LAUNDRY
KLEEN-RITE LAUNDRY SIGNS

• 12" x 16" • PVC construction

\$16.43 SIKRL304



USE AT YOUR OWN RISK
KLEEN-RITE LAUNDRY SIGNS

• 15.5" x 25" • PVC construction

\$21.43 SIKRL500



WASH/DRY INSTRUCTIONS
KLEEN-RITE LAUNDRY SIGNS

• 15.5" x 25" • PVC construction

\$21.43 SIKRL501



CAUTION SIGNS
SAFETY SIGNS

• 2 sided

Rubbermaid

\$17.99

SFT2150	English Only
SFT2150-MULTI	English/ French/Spanish

JANITORIAL & LAUNDRY

BILINGUAL INSTRUCTIONAL SIGNAGE & DECALS



No permiten que los niños jueguen con los carros de lavandería

NO CHILDREN IN CARTS BILINGUAL

KLEEN-RITE LAUNDRY SIGNS

• 13.5" x 16" • PVC construction

\$17.14 SIKRL400



No somos responsables de ropa perdida o daño a la ropa.

NOTICE - NOT RESPONSIBLE FOR DAMAGE BILINGUAL

KLEEN-RITE LAUNDRY SIGNS

• 13.5" x 16" • PVC construction

\$17.14 SIKRL401



Para el lavado mejor, no sobrecargues las máquinas.

DO NOT OVERLOAD MACHINES BILINGUAL

KLEEN-RITE LAUNDRY SIGNS

• 13.5" x 16" • PVC construction

\$17.14 SIKRL402



Por favor, no pongan sus niños en los carros o encima de las mesas, gracias!

NO CHILDREN - CARTS/TABLES BILINGUAL

KLEEN-RITE LAUNDRY SIGNS

• 13.5" x 16" • PVC construction

\$17.14 SIKRL403



No se sienten en las mesas o las lavadoras.

DO NOT SIT ON TABLES BILINGUAL

KLEEN-RITE LAUNDRY SIGNS

• 13.5" x 16" • PVC construction

\$17.14 SIKRL404



Padres, favor de supervisar sus niños, no correr o jugar. Gracias!

PLEASE WATCH CHILDREN BILINGUAL

KLEEN-RITE LAUNDRY SIGNS

• 13.5" x 16" • PVC construction

\$17.14 SIKRL405



Devuelva los carros a al lavandería después de cargar su coche

PLEASE RETURN CARTS BILINGUAL

KLEEN-RITE LAUNDRY SIGNS

• 13.5" x 16" • PVC construction

\$17.14 SIKRL406



Para obtener los mejores resultados, sugerimos usar menos detergente con estas lavadoras. Intentar 1/2 tanto como usted normalmente utilizaría.

USE LESS SOAP BILINGUAL

KLEEN-RITE LAUNDRY SIGNS

• 13.5" x 16" • PVC construction

\$17.14 SIKRL407



Gracias por retirar su ropa tan pronto que termine la máquina

THANK YOU BILINGUAL

KLEEN-RITE LAUNDRY SIGNS

• 13.5" x 16" • PVC construction

\$17.14 SIKRL408



4 PIECE POLE KIT & GROUND SPIKE OR X-STAND HARDWARE SOLD SEPARATELY!

12' FEATHER FLAGS LAUNDRY FLAGS

- Nylon
- Message on one sides
- 15' x 2.5' (with stand)
- 12' x 2.5' (w/o stand)
- **FLAG STANDS/POLES SOLD SEPARATELY**

\$24.99 CWF12301 FLAG

\$69.99 CWF1702 X STAND

\$49.99 CWF50212 KIT

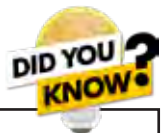

INSTRUCTION & WARNING SIGNS ARE A GREAT ADDITION TO YOUR LAUNDRY FACILITY.

Adding informational, instructional and warning signs to your laundry facility will help keep your business looking professional, clean, and safe. Letting your customers know your policies and procedures will help keep them happy and help reduce incidents that can cost you money!

JANITORIAL & LAUNDRY

DECALS, OVERLAYS & TAGS



TIDE DETERGENT
LAUNDRY OVERLAYS

LD01000



TIDE POWDER WITH BLEACH
LAUNDRY OVERLAYS

LD01050



BOUNCE DRYER SHEETS
LAUNDRY OVERLAYS

LD01100



CLOROX 2
LAUNDRY OVERLAYS

LD01200



DOWNY FABRIC SOFTENER
LAUNDRY OVERLAYS

LD01300



CLOROX LIQUID BLEACH
LAUNDRY OVERLAYS

LD01400



OXICLEAN 1 OZ
LAUNDRY OVERLAYS

LD01500



SNUGGLE DRYER SHEETS
LAUNDRY OVERLAYS

LD01700



SNUGGLE LIQUID FABRIC SOFTENER
LAUNDRY OVERLAYS

LD02100



GAIN DETERGENT
LAUNDRY OVERLAYS

LD01800



DISOL-VOL
LAUNDRY OVERLAYS

LD02800



ALL POWDER DETERGENT
LAUNDRY OVERLAYS

LD02900



3 COLUMN LAUDRAMAX DECAL
LAUNDRY DECALS

VE0133



OUT OF SERVICE TAG
LAUNDRY ACCESSORIES

• 50 pack

\$16.13 LD0011

BILINGUAL "USE LESS SOAP" DECALS

LAUNDRY DECALS

• 20 Decals

\$8.45



LD0015	1/4 Cup
LD0020	1/3 Cup
LD0025	1/2 Cup

INDEX

A

- Abus Locks 303, 405
- Acceptors
 - Coin
 - CM 358
 - GinSan 357
 - IDX 359
 - Imonex 302, 358-359
 - MA850 46
 - Magikist 360
 - Microcoin 46, 360
 - Multitron 357
 - Parker 357
 - Sensortron 357
 - Slugbuster 46, 357
 - Bill
 - CPI/Talos 274, 356
 - Coinco 273-274, 355
 - Pyramid 273, 355
- Accumulator 215, 223
- Adapters
 - Blue-White® Pump 230
 - Bolt 564
 - Double (for polisher) 193
 - Duct 483
 - Female Flare 658, 660
 - Female x Male Pipe 658
 - Female to Pipe 660
 - Flare Tube Pipe 662
 - Hose (vacuum) 315-317
 - Hose 315-317, 655
 - Hub 51
 - Hydraulic 660
 - Hydra-Flex 383
 - Male Flare 658
 - Mounting 304
 - Procon® Pump 237
 - Quick Coupler 729
 - Rail Kit 216
 - Reusable 661
 - Stem 646
 - Swivel to Male 660
 - TeeJet® Fitting 379
 - Tip 533
 - Triggerjet® 384
 - Triple-Lok® 662
 - Unijet® 380
 - Vac Hose 319-320
 - Vac Nozzle 315-316, 318
 - Wall Plug 273, 355
- Adjustable
 - Air Compressor Blow Gun 309
 - Ball Fitting 379
 - Ball Type Nozzle Body 381
 - Brush Assembly 595
 - Ceiling Boom 415-418
 - Clean Out Bag 302, 321
 - Flowmeter 716
 - Foamers 190
 - Injectors 528, 541, 726-727
 - Nozzles 599, 613
 - Overload Protectors 268
 - Panel Mount Flowmeter 716
 - Rain Suits 163
 - Regulators 252
 - Spray Gun 371
 - Soap Injector 613
 - Solenoid Valve 618
 - Trigger Gun 371
 - Trigger Sprayers 158
 - Undercarriage Cleaner 446
 - Unloaders 254, 257, 612
 - Vent Kit 481
 - Water Driven Pump 731
- Air Activator 205
- Air Compressors
 - Champion 475
 - Gast 309, 312
 - Drain Valve 477
 - Lubricant 477
- Air Cylinders 559
 - (for) Ryko® 509-510, 513, 516
- Air Dancer 422
- Air Dryers
 - Air Dryer Combo Vac 296
 - Air Shammee 449-450
 - AutoDry/Air Logic 451
 - Automatic Dryer 566
 - Conveyor Dryer 566
 - Desiccant 265
 - Flojet Extractor/Dryer 265
 - Heavy Duty Warm Air Dryer 457
 - Hot Air Dryer 293
 - In-Bay Hand Held Dryer 451
 - Pet Wash 457
 - Proto-Vest 566
 - Turbo Towel 451
- Air Dryer/Vacuum Combos 296
- Air Fresheners
 - Aerosol 92, 101
 - Arm & Hammer™ 99-100
 - ArmorAll® 88
 - Axe 89
 - Bomb Air Fresheners™ 96
 - California Scents® 92-93
 - Can/Fiber/Gel 86-89, 91-93, 97
 - Car-Freshner® 55, 79-87
 - Characters 78
 - Citrus Magic® 101
 - Custom Fresheners™ 96
 - Custom Air Freshener Order CALL/16
 - Dakota Products, Inc. 13
 - Driven™ 88
 - Febreze® 55, 98
 - Hero Clean® 101
 - Jenray® 94-95
 - Little Trees® 55, 79-84
 - Moonshine Jars 94
 - Nationality/Flags 94
 - Ozium® 97
 - Plasticolor 78
 - Pump/Spray 86, 91-92, 99, 102
 - Quick Dry® 76
 - Refresh Your Car® 90-91
 - Scents™ 97
 - Scent Stones® 103
 - Star Wars 78
 - Sterling Teal Tin Scents 103
 - Superhero 78
 - Yankee Candle® 102
- Vent Clips
 - Armor All® 88
 - Arm & Hammer™ 99-100
 - Axe 89
 - Febreze® 98
 - Ventations/Dakota Products 103
 - Yankee Candle® 102
- Vent Liquid™ 86
- Vent Sticks
 - California Scents® 93
 - Refresh Your Car® 90
 - Vent Wraps® 85
- Vent Oil
 - Refresh Your Car® 90-91
 - Scents™ 97
- Air Freshener Decals 104-105
- Air Hose Assemblies 309
- Air Inflators & Parts 306-309, 311-312
- Air Logic
 - Autodry 451
- For Automatics
 - Double Function Panel 560
 - Single Function Panel 560
 - Triple Foam Wall Mount Panel 560
 - In Bay Dryer 451
 - Low Pressure Systems 461
 - Triple Foam Systems 461
- Air Machines
 - Air 306-307, 311
 - Air/Vac Combo 312
 - Air/Water Combo 308
 - Air/Water/Vac Combo 306
 - Digital 307
 - Economy 307
 - Free/Push Button 306
 - GinSan (IVS) 311
 - J.E. Adams 307-308
 - J.E. Adams Parts 309
 - Retractable Base 308
- Air Machine Decals 309
- Air Machine Replacement Parts 309
- Air Pumps
 - Flojet 236, 525, 533, 541
 - For Crimper 661
 - For Sonny's®
 - Tire Dressing Control Panel 525
- Air Regulators
 - Mini 261, 263
 - Composite 262
 - Filter Regulator 260
- For Sonny's®
 - Tire Dressing Control panel 525
- Module/Air 262
- Parker 262
- Air Sanitizer 97
- Air Shammee
 - Air Shammee I & II 449
 - Signs & Banners 450
 - Replacement Parts 450
- Air Switches 403
 - For MacNeil® 543
 - For Ryko® 514
 - For Sonny's 518
- Air Switch Parts 403
- All Systems Polymer Pre-Soak 678
- All American Towel 75
- Allen Bradley 268
- American Changer
 - Bill Changers 270-272, 747
 - Bill to Bill Dispensers 271, 747
 - Cash, Coin & Card "Token" Disp. 271
 - Changer Parts 272
 - Coin Counter 284, 746
 - Compact Coin Counter 284, 746
 - Decals/Stickers 272
 - Front Load Changers 271-272, 747
 - High Security Front Load 272
 - Hoppers 272
 - Multi-Bill Changer 271
 - Rear Load Changers 270, 747
 - Token Dispenser 271
- American Flag
 - Air Dancer 422
 - Air Freshener 79, 81, 84, 94
- American Locks™ 406
- Ametek
 - Vacuum Motor 330-331
 - Vacuum Motor Brushes 329
- Anchors
 - Bolt Down Foot Assembly 53
 - Concrete (for bollards) 336
 - Hose 403
 - Nylon Tapit 434
- Anti-Freeze Chemicals
 - Cryo-Tek Floor Heat 484
 - JBS® 688
 - Kleen-Rite 688
 - Simoniz® 688
- Anti-Freeze Systems
 - Easyheat® 459
 - Easyheat® Freeze-Free Cable 459
 - Easyheat® Connection Kit 459
 - Easyheat® Preset Thermostat 459
 - Floor Heat Anti-Freeze 484
 - Radiant Heat Tubing 481
 - SubZero 459
 - Weepmizer 460
- AP Formulators
 - Brick Renew 714
 - Klean Wall 472, 714
 - Klean Wall II 472, 714
 - Pit Enzyme 486
- Applicators
 - Bottle 158
 - Ceramic Applicator Pad 173
 - Detail/Dressing/Wax 59, 73, 76
 - Dress-Pro Tire 186
 - Mother's® 150
 - Motor City Wash Works®
 - Conveyor-Super Duty™ 534, 536
 - Microfiber/Pads 169, 172-176
 - Rain Rope Ribbon 561
 - Sonny's®
 - CTA Tire & Wheel 521
 - Double & Triple 525
 - Presoak 521
 - Tire Dress Express 160
 - Tire Shine 160
 - Wax Pad (Simoniz®) 59
 - Wheel 179, 397
- Aprons 163
 - Aqua Master 723
- Aquatec Pumps 251
- Arch Encoder 546
- Arch Kit
 - Simoniz® Ceramic Sealant 694
 - Simoniz® Carbonite 695
- Arch Lighting
 - G&G LED 349
 - GPX 346
 - Top Only 349

Tunnel.....	348
Immersive.....	349
WPX.....	346
Arch Spray Assemblies.....	380-381
Arch Vacuum Systems	
J.E. Adams.....	289-291
IVS (GinSan).....	311
AR North America	
Balanced Relief Valve.....	255
Blue Clean Brush Kit.....	595
Heavy Duty Rotating Nozzle.....	382, 600
Pressure Cleaning Pumps.....	243, 608-609
Pumps.....	243, 608-609
Turbo Nozzle.....	382, 600
Unloaders.....	255, 610
Arimitsu	
For Hanna™ Water Wizard.....	542
For Sonny's® Pressure Gun Unit.....	521, 522
Pumps.....	227-228, 521-522
Pump Oil.....	228, 542
Armor All®	
4 oz. Flat Bottles.....	54-55, 61
Air Fresheners.....	88
Air Freshening Protectant Spray.....	120
Car Care Kit.....	44, 124
Car Wash Concentrate.....	123
Cleaning Sponge.....	60
Decals.....	107, 110, 112
Detail.....	142
Extreme	
+ Ceramic.....	119, 121
+ Graphene.....	121
Bug & Tar Remover.....	121
Tire Foam.....	122
Tire Shine.....	122
Shield Protectant.....	121
Wheel & Tire Cleaner.....	122
FreshFX™	
Duct Cleaner.....	120
Odor Eliminators.....	120
SmokeX™ Spray.....	120
Vent & Duct Cleaner.....	120
Vent Clip.....	88
Gift Pack.....	124
Glass Care	
Spray.....	123
Wipes.....	124
Leather Care.....	64, 123
Protectant	
4 oz. Vending Spray.....	61
Detail Chemicals.....	142
Pouch Wipes.....	124
Sponge.....	55, 60
Sprays.....	121-123
Tub Wipes.....	119, 121, 123
Pouch Wipes.....	124
Retail.....	119-124
Retail Displays.....	119
Snow Foam.....	123
Sprays	
Air Freshening Protectant.....	120
Auto Glass.....	61, 123
Extreme	
Bug & Tar Remover.....	121
+ Ceramic.....	121
+ Graphene.....	121
Shield Protectant.....	121
Tire Foam.....	122
Tire Shine.....	122
Wheel & Tire Cleaner.....	122
FreshFX®	
Duct Cleaner.....	120
Odor Eliminators.....	120
SmokeX™.....	120
Heavy Duty	
Multi-Purpose Cleaner.....	120
Wheel & Tire.....	120
Leather Care.....	64, 123
Original Protectant.....	60, 123
Tire Foam.....	55, 60, 122
Tuff Stuff®	
Multi-Purpose Foam.....	122
Stain Remover.....	122
Wheel & Tire.....	122
Tire Foam.....	60, 122
Tire Foam Vendor.....	42
Top Sellers (Vending).....	60-62, 66-67, 69
Towels & Wash Mitts.....	124
Tub Wipes (Retail).....	119
Ultra Shine	
Protectant.....	119
Tire Foam.....	122
Total Vehicle Detailer.....	121
Trim & Tire Sponge.....	60
Wash & Wax.....	123

Headlight Restoration Wipes.....	124
Vending.....	88
Wipes	
Air Freshening.....	119
Cleaner.....	61-62, 64, 124
Displays.....	119
Extreme Shield Protectant.....	121
Extreme Shield +Ceramic Leather.....	121
Glass Cleaner.....	62-63, 124
Leather.....	61, 123
Protectant.....	61
Pouch	
Cleaning.....	64
Glass.....	62-64
Leather.....	64
Protectant.....	63
Ultra Shine.....	123
Vending.....	61
ARO	
Air Cylinder.....	562
Air Filter.....	262
Kits (Pump).....	242
Piggyback Filter.....	262
Pumps.....	242
Mini Regulators.....	261
Regulators.....	261
Asco Solenoids	
For Motor City Wash Works®	
Valves/Pumps.....	532, 534
Normally Closed (Low Pressure).....	624
Normally Open (Low Pressure).....	624
Normally Closed (3-Way).....	624
"S" Series.....	624
Asco Female Din Connectors.....	624
Ash/Smokers Stations.....	333, 739
Assemblies	
Air Hose.....	309
AR North America	
Boxed Pump Package.....	609
Belanger®	
Duratrans Roller.....	527
Boom	
Kleen-Rite.....	415-416
Mosmatic.....	416-418
Suttner.....	416
Zierden.....	418
Brass Trigger Valve.....	203
Cat Pumps®	
Rear with Plungers.....	208
Classic & Rainmaker Parts	
6 Wire Center Pod.....	502
Coinbox Heater.....	413
D&S	
Idle Bar.....	548
Flojet®	
Baseplate.....	238
Check Valve.....	235-238
Motor.....	238
General Pump®	
Packing.....	216, 218-219
Gutter Cleaner.....	595
Hamilton Changer	
Coin Mech Transformer.....	281
Heater.....	281
Hopper.....	281
Handwringer Top.....	369
High Pressure Gun/Hose.....	370
Hose	
Air Hose.....	309
Comfort.....	667
Custom.....	664-665
Dog Wash Dryer.....	457
Dog Wash Shower Head.....	457
Foamy.....	390, 665
Fragrance.....	323-325
Heavy Duty Dryer.....	457
Sonny's® Pressure Gun Unit.....	521-522
Wash Hose.....	457
Wire Braid.....	670
Hose & Brush (Fragmatics®).....	324-325
Hose & Brush.....	370
Hose & Gun.....	370
Hose & Handle (Fragmatics®).....	323, 325
Hydrominder	
Actuator.....	722-724
Eductor.....	720-723
Float & Chain.....	722
Suction Tube.....	722
Lance/Wand.....	592-594
Laserwash G5™	
Breakaway Bolt.....	546
Laurel Vendor	
Coin Cup Motor.....	46
Model 2100 Magazine.....	47

Model 300 Magazine.....	47
Pull Rod.....	49
Ratchet Pawl.....	47
Vend Motor.....	46
Mega-Vendor®	
Bolt Down Foot.....	53
Motor City®	
Conveyor-Super Duty™ Roller.....	532
Plunger.....	633
Roller.....	492
Ryko®	
Roller.....	509-517
Sonny's®	
Pressure Gun Unit	
Hose.....	522
Pump Rail.....	521
Southern Pride®	
Bearing House.....	545
Disc.....	545
Drive Shaft.....	545
Idler Shaft.....	545
Spray Arch.....	380
Underbody Cleaner Wand.....	447
Unijet®.....	379-380
Unitec Wash Select Keypad.....	536
Whip.....	309
Windmaster Wheel.....	424
Autec®	
Foam Replacements.....	581
Cloth Replacements.....	582
Automatic Dryer.....	566
Automatic Replacement Parts	
Air Cylinders	
Ryko®	
Dryer.....	513
Softgloss Top.....	509
Softgloss Front/Rear.....	510-511
NFPA.....	562
Autec®	
Cloth.....	582
Foam.....	581
Swivels.....	643
Car Wash Tanks.....	461, 471, 560
Bearings.....	500-501
Belanger®	
Check Valves/Nozzles.....	529
Duratrans & Duratrans XD®.....	527
Dryer.....	527
Front-To-Back Mitter.....	580
Hubs/Swivel/Turbo Arms.....	528
Nozzles.....	529
Side & Wrap Around Brush.....	528
Tire Brush.....	528
Top Track Pro.....	527
Valves/Shock/Oil Reservoir.....	528
Vector Rapid Wash™.....	530
Rollers.....	514, 517, 532, 558
Cloth & Foam.....	531
Mitters.....	531, 278
Bushings	
Chain.....	537
Chain & Roller Chart.....	491
Cloth	
Autec®.....	581-582
Belanger®.....	531, 569-570, 578
Econocraft®.....	571, 579
Five Star.....	581-582
Hanna™.....	572-574
Peco.....	579
Sonny's®.....	575-577, 580
C188.....	499, 527, 539
Couplers/Couplings.....	497, 499, 508, 523, 528, 539
D88K Chains & Parts.....	498, 537, 539
D81X Chains & Parts.....	498
D&S®.....	548, 643
Econocraft®	
90° Swivel.....	643
Foam & Cloth.....	571, 579
Rollers.....	491-497
Mitters.....	579
Foam	
Autec®.....	581-582
Belanger®.....	569-570
Econocraft®.....	571
Five Star.....	581
Hanna™.....	572-574
Sonny's®.....	575-577
Foam Generators.....	184-185
Flanges.....	500-501
Flanges (For Hydro-Spray).....	504
Flanges (For Ryko®).....	509
Flanges (For Sonny's®).....	519-520, 523
Flanges (For Belanger®).....	527
Flanges (For Motor City®).....	533
Flanges (For Hanna™).....	537

Hanna™	Auto Prep Washer.....	543	Pressure Gun Units.....	521-522	Barstock Fittings.....	657-658
	Cloth & Foam.....	572-574	Rollers.....	497,526-527	Barrel Mixers.....	718
	Conveyor.....	537	SC78 Chain.....	519	Bay Signs.....	432-444
	Drive Sprockets.....	537	Bottom Motor Side.....	524	Bay Timers.....	359-369
	Drum & Take Up Sprockets.....	537	Top Motor Side.....	524	Bay Wall Cleaner.....	474, 707
	Hydraulic Motor & Gear Box.....	537	SF50 Front Grill Brush.....	524	Baywatch Bayheat	
	Hydraulic Motors.....	537	Spring Take-Up Entrance.....	519	Accessories.....	481
	Pumps/Valves/Hydrominders.....	541	Tape Switches.....	518,555	Electric Heaters.....	481
	Mitter Motors & Parts.....	540	TBG200 Tire & Wheel.....	523	Radiant Heaters.....	481
Rollers			Tire Dressing Control Panel.....	525	Bearing, Ball Swivel.....	637
6 Wheel-High Profile . 493-494,496,538			Tire Seal Machines.....	525	Bearings.....	509-511,523
6 Wheel-Low Profile.. 493-494,496,538			Top Brush 2K14.....	523-524	Automatics.....	501
RCV Style 492, 538			Wipe-O-Matic.....	526	Belanger®.....	527
Surface Conveyor.....	537		Wrap-Around.....	525	Hanna™.....	537, 539
Valves/Injectors.....	541		X458 Chain.....	519	Hydro-Spray.....	505
Water Wizard.....	542				Laserwash G5™.....	546
Cloth & Foam.....	531, 568-582	Southern Pride			Motor City® Wash Works.....	533
Hydro-Spray.....	502-508	Parts.....			Ryko®.....	509-511
LaserWash		Tire Brushes			Sonny's®.....	523
General Parts.....	546-547	Erie Wheel Wonder®.....			Bearing House Assembly.....	545
Valves.....	547,620	Universal Brush.....			Bell Hose.....	403,514,518,543
Loop Detectors.....	563-564	Treadles/Switches			Belanger®	
Lubricants/Anti-Seize.....	559	Londonmat.....	507, 518, 532, 555		6 Wheel Rollers & Parts.....	495,497,530
MacNeil®		Recora®.....	554		Cloth & Foam.....	531,569-570
Chain.....	544	Tapeswitch.....	507, 518, 532, 555		Mitters.....	578
Check Valves.....	544	Automatic Soap			Replacement Parts.....	527-530
Hydraulic & Electric Drives.....	543	JBS Industries®.....	687-688,710-711		Side Washer Cloth & Foam.....	531,570,573-574
Rollers.....	492, 544	Kleen-Rite.....	676-679,687-688		Belt-Driven Pressure Washers	
RG44.....	543	Kleen-Track.....	680-681		Pressure Pro®.....	587
Mitters		National.....	708, 715		Belt-Driven Prep Units.....	462
Belanger®.....	578	Shore.....	712-713		Belt-Driven Pumps	
Econocraft®.....	579	Simoniz®.....	683-685,687-688,696-697,702-703		Arimitsu.....	228,521-522
Peco®.....	579	Trans-Mate™.....	704-705		CAT Pumps®.....	215,521
Sonny's®.....	580	AVW			Hydra-Cell.....	521
Misc/Popular.....	547	Swivel.....	643		Belts.....	269,507,515,522,546
Motors		Awnings			Belts (Bridge Drive).....	546
Char-Lynn®.....	556-557	Vacuum.....	291,314		Belts (Changers).....	281, 285
Parker.....	558	B			Belts (Gantry Timing).....	515
Sterling.....	558	Backflow Prevention.....	633, 723		Belts (Trolley Timing).....	546
Motor City Wash Works®		Bags			Bend Restrictor-Hose.....	663
Conveyor		Caddy Bag.....	740		Berkeley Pumps.....	242
Applicators.....	532-533	Garbage.....	332, 740		Bi-Lingual	
Bearings & Brushes.....	533	Laundry.....	118, 736, 744		Banners.....	431
Chemical Supplies.....	533	Vacuum Clean Out.....	302, 312, 321		Bay Signs.....	437
Cylinders/Shocks/Pumps.....	535	Vacuum Filter.....	298,301,312,322		Deluxe Signs.....	437
Electric Motors.....	536	Wind Shield Wiper.....	164		Decals.....	440-445
Hydraulic Motors.....	536	Banjo Fittings.....	651-652		Instruction Signs.....	432-442
Nozzles.....	534	Balanced Pressure Regulators			Laundry Signs & Decals.....	117,749-751
Pumps.....	535	General Pump®.....	547		Menu Signs & Strips.....	440,685,694
Super Duty™.....	532	J.E. Adams.....	252		Rotary Decals.....	441
Valves/Pumps.....	534-535	Kleen-Rite.....	252		Windmaster Signs.....	424-428
Wash Street.....	532	The Speciality Mfg. Co.....	253		Bill Acceptors	
Proximity Switches.....	549	Balanced Relief Valve			Add-On Boxes.....	412
Roller & Chain Chart.....	491	AR North America.....	255		Coinco.....	56,273-274,355-356
Rollers.....	492,514,517,532,558	General Pump®.....	612		CPI Talos.....	56,274,356
Ryko®		Kleen-Rite.....	252		Pyramid.....	273,355
Air Manifold.....	513	Suttner.....	255		Bill Acceptor Cleaning Card.....	288
Bay Switches.....	513	Balanced Unloader			Bill Breakers	
Chemical Distribution.....	513	Kleen-Rite.....	252		American Changer.....	270-272,747
Drye.....	513	Baldor Motors			Hamilton.....	278-281,748
Hydraulic & Electric Devices.....	514	For Belanger®			Rowe.....	282-283,748
Popular Parts.....	515-517	Conveyor-Top Track Pro.....	527		Standard.....	276-277,748
Reclaim.....	512	For Hanna™.....	543		Triad.....	275,747
RG440 Conveyor.....	514	For Motor City Wash Works®.....	536		Bill Changers	
Rollers & Chains.....	514	For Sonny's®			American Changer.....	270-272,747
Softgloss		Air Drying Machines.....	526		Hamilton.....	278-281,748
Electrical Panel.....	512	Hydraulic Power Pack.....	526		Rowe.....	282-283,747
Front/Rear Brush.....	510-511	Motors.....	228,527		Standard.....	276-277,748
Wheel Scrubber.....	511	Ball Bearing Swivel.....	639		Triad.....	275,747
Sensors.....	489-490	Ball Bearing Swivel (Repair Kit).....	637		Bill Changer Signs.....	433
Sealants.....	559	Ball Bearing Swivel, Brass.....	637,640		Blow Gun.....	309
Simoniz®Pad Perfect.....	562,683-684,701	Ball Valves.....	628		Blue Magic®	
Sonny's®		Banner			Decals.....	63-64,111
Air Drying Machines.....	525	LED Light Strips.....	352		Retail	
Air Take-Up Entrance.....	519	Photoelectric Sensors.....	551		Carpet & Stain Lifter.....	122,125,130
Bell Hose Tire Switch.....	518	Cord Sets.....	551		Headlight Care.....	124-125
Buff-N-Dry Top Brush.....	526	Banners			Leather Care.....	119,121,123,125
Cloth.....	531,562-582	Air Shamnee.....	431		Metal Polish.....	125
Conveyor.....	518-520	Car Wash.....	431		Vending	
Conveyor Entrance.....	519	Dog Wash.....	431, 456		Auto Glass Cleaner.....	45,61-63,77
CTA Tire & Wheel.....	521	Express Detail (Simoniz®).....	431		Black Jack.....	63
Double & Triple Applicators.....	525	Free Vacuums.....	431		Bug & Tar Remover.....	63
Easy Clean Foamer.....	521	Self-Serve.....	431		Glass Wipes.....	63
Exit Motor Drive Options		Triple Foam.....	431		Leather Care.....	61,64
Hydraulic.....	520	Unlimited Wash Club.....	431		Never Fog.....	63
Electric.....	520	Basket Strainers.....	266		Vinyl Care.....	63
Foam		Banjo.....	651		Blue Magic Foaming Wax.....	693
Front-To-Back Mitter.....	524	For Ryko®.....	512		Blue White Industries	
Go®Switch.....	518	John Guest®.....	646		Panel Mount Flowmeter.....	716
Hydraulic Power Pack.....	526	Parker.....	650		Blue White Pumps	
Log Chain.....	519	Poly, Straight.....	651		For Motor City Wash Works®.....	535
Mitters.....	580	Push Lock.....	656		For Ryko®.....	513
Omni Wash Arches.....	525	PVC.....	634		Pumps.....	230,535
Photo Eyes.....	518	Splicer.....	656		Pumps Parts & Accessories.....	230,513
					BoarTex Foam Brush.....	394-395

Bob® Float Valves.....	629
Body Drying Towels	
The Champ®.....	72
Towels By Doctor Joe®	
Ambassador.....	32
Black Super Plush.....	39
Microf. ...25-30,33-34,37,39,169,172-176	
Think Thick.....	32
True Color.....	32
Ultra.....	30,33-34
Water Mop.....	32
Boiler.....	482
Bollard Covers	
Ideal Shield®.....	335
PostGuard®.....	336-337
Value Line.....	335
Booms	
360° Swivel Boom.....	290
Accessories.....	415-418
Adjustable.....	416
Air Dryer.....	451
Air Shammee.....	449
Air System.....	446
Auto Dry.....	451
Bumper.....	415
Ceiling Mount.....	415-418
Complete Assembly.....	418
Conversion Kit.....	418
Dual/Double.....	415,417
Drop Down Stems.....	418
Kleen-Rite	
Brackets.....	415
Bumpers.....	415
Ceiling Mount.....	415-418
Double Boom.....	415
Parts/Accessories.....	415
Wall Mount.....	416
LED Ceiling.....	417
Magnetic Position Device.....	418
Maxi-Flex.....	416
Mighty Clean.....	416
Mosmatic.....	416-418,446
Mounting Bracket.....	418
Overhead Swivel Cartridge.....	418
Stop for Coleman Booms.....	415
Suttner.....	416
Swivels.....	638-640
Vacuum.....	293
Wall Boom Extension.....	417
Wall Mount.....	415-416
Zierden.....	418
Boomerang Foaming Units.....	561
Boot Covers.....	162
Boxes	
Coin Box Assembly (Vacuum).....	301
Coin/Meter/Bay.....	414-416
Vacuum Coin.....	304
Brass	
Adapter.....	379
Adjustable Ball Fitting.....	381
Adjustable Injector.....	528,514,726
Ball Bearing Swivel.....	637,639
Barstock Fittings.....	657-658
Boom Swivel.....	639-640
Breakaway Fittings.....	374
Breakaway Swivel.....	638
Brush.....	180
Bulkhead Fittings.....	471
Check Valves.....	520,634-636
Connectors/Elbows.....	647
Discharge Fittings.....	374
Drain Cleaning Nozzle.....	375, 601
Drop Elbow.....	647
Elbow.....	648,654
Female Drop Elbow.....	647
Float Valve.....	635
Floodjet® Spray Tips.....	378
FoamJet® Nozzles.....	378
Foot Check Valve.....	598,635
High Pressure Check Valve.....	520,635
High Pressure Strainer.....	265
Hose Reel Swivel.....	606,637
Injectors.....	528,541,612,726
Inline High-Pressure Filters.....	601
Intake Filter.....	266
Karcher Type Fittings.....	597
Male Connector.....	654,659
Manifold Blocks.....	616,620,622
Mini Regulator.....	263
Nozzle Body.....	379
Nozzle Caps.....	379
Padlocks/Pinlocks.....	405-406
Plumbing Fittings.....	647
Polytube/Push-In Fittings.....	646,654
Pumps.....	207-208, 218-219, 222-229,

.....	233-234, 243
Push-In Fittings.....	654
Quick Disconnect Sockets/Plugs.....	203, 597
Regulators.....	258-261,610
Safety/Pop Off Valves.....	627
Solenoids.....	542,547,619-621
Spray Guns.....	370-373, 588-589,623-626
Spray Gun Fittings.....	374
Spindles.....	545
Steam Nozzle.....	601
Stems.....	629,647
Straight Swivel.....	637-639
Strainers.....	265,379
Swivels.....	637
Swivel Elbow.....	654
Toothbrush Style Brushes.....	178,181,397
TeeJet®.....	529
TeeJet® Fitting Adapter.....	379
TeeJet® Tip Retainer.....	529
Trigger Valve Assembly.....	203
Triggerjet®.....	384
Triggerjet® Nozzles.....	384
UniJet® Nozzles/Tips.....	379, 529
Union Elbow.....	654
Unloaders.....	610-612
Valves.....	258-260
Breakers (Bill)	
American Changer.....	270-272,747
Hamilton.....	278,281,748
Rowe.....	282-283,747
Standard.....	276-277,748
Triad.....	275,747
Breakers	
Pump Overload Circuit For Ryko®.....	512
Resettable.....	413
Brick Renew.....	714
Brooms	
Corn.....	181-182
Deck/Pressure Wash.....	583-595
Handles.....	182,403
Heavy Duty.....	181-182
Multi-Surface.....	182
Outdoor.....	181-182
Push	
Squeegee.....	181
Water/Pressure Wash.....	584-587
BoarTex.....	394-395
Erie.....	178-179,398-400
Brush Holder.....	392
Detail.....	178-179, 181
Foammaster®.....	398-399
Hogs Hair.....	178-179,393-402
Replacement Parts.....	397,399
Round Foammaster®.....	399
Rubber Bumper.....	397,399
Spoke Brushes.....	179,400
Synthetic.....	394-397
Triple Surface.....	395-396,399-400
Truck.....	399-400,402
Wheel Wizard®.....	400
Wheel Wonder®.....	567
Harper.....	180-182
Gong.....	180
Utility.....	180
Handles.....	182,403
Prep.....	396
Push/Outdoor.....	181-182
Hog Daddy.....	401
Hog King.....	401
Mosmatic.....	393
Universal.....	178-179,394-397
Bi-Level.....	400,402
Hogs Hair.....	178-179,393-402
Monster & Monster XL.....	394
Parts.....	397,399
Poodle	
Prep.....	523,567
Round.....	395-397,399,401
Spare Parts.....	397,399
Stack.....	397
Standard Tire.....	179-180
Synthetic.....	394-397
Tire, Cloth.....	567
Tire Dressing.....	567
Tire, Round.....	395,397
Toothbrush Style.....	178,181
Triple Surface.....	395-396,399-400
Truck.....	396,399-400,402
Upholstery.....	178,180
Wheel.....	179,395-397
InkFish®.....	401
Kleen-Rite.....	401
Value Line.....	401-402
Weiler®.....	180,182,402
Brush Bucket.....	392

Brush Handles.....	182,389,391,403
Brush Handle Holder.....	392
Brush Holders.....	392
Brute®.....	740
Buff & Shine.....	187
Buffalo Stainless Steel Lock.....	405
Buffing Pads.....	192,199
Buffing Pad Cleaning Tool.....	159
Buffing Pad Washer.....	159
Buffers/Polishers	
Cyclo®.....	199
Flex®.....	195-198
Meguiar's®.....	195
Rupes®USA, Inc.....	193-194
Bug B Gone.....	143,146
Bug Block Remover Brush.....	160
Bug & Tar Removers	
Aerosol.....	137
Armor All®.....	121
Blue Magic®.....	63,125
Bug Eraser.....	137
Bug Master.....	682
Chemicals	
JBS Industries®.....	709-711
Kleen-Pak.....	689
National Automotive Chemical.....	707-708
Trans-Mate™.....	704-706
Shore Corporation.....	712-713
Decals.....	108,111
Detail & Retail	
Armor All®.....	119-124
Meguiar's®.....	127-131,151-154
Mother's®.....	135
Stoner.....	137
Don't Bug Me.....	685
Meguiar's®.....	135
Menu Strips.....	440
Quick-Dry®.....	75-77
Signs.....	425,438
Simoniz®.....	685
Spray.....	135,137,155
Stoner®.....	137,155
Wipes.....	137
Bug Master.....	682
Bug Master Sign.....	425
Bug Remover Decals.....	108,111
Bug Remover Sign.....	438
Bulkhead Fittings.....	478
Bulkhead Fitting with EPDM Gasket.....	651
Bulkhead Fitting with Swivel.....	528
Bulkhead Union.....	650
Bushings	
1¼".....	502
2mm.....	522
5/8".....	505
Boom.....	415
(for) Cat Pumps® 5CP2120W.....	208
(for) Cat Pumps® 5CP2120B.....	208
Double Groove.....	269
(for) General Pumps® GPHTS2215SR.....	216
(for) General Pumps® PEHT2214S.....	216
H Bushing.....	216,269
Hose & Fittings.....	653,657
Male x Female Pipe.....	657
Roller.....	492
Single Groove.....	269
Tapered Lock.....	499,519-520
Buzzer	
Audible Alert/GinSan®.....	363
Breakaway (Break Away/Break-Away)	
Assembly Bolt.....	546
Fittings.....	374
Manifold Block.....	546
Swivel.....	638
C	
Cable	
20 GA/18 Cond.....	507
AWG Tray.....	503
Banner.....	551
Cat 5.....	468,745
Freeze-Free.....	459
Lube.....	414
(for) Pantron QC Sensors.....	550
Restraining (Pet Wash).....	557
Siamese Video.....	465
Sensor for Proximity Switch.....	549
(for) Telco Sensors.....	552
Ties.....	413
Weep Mizer Replacement.....	460
Cable Ties.....	413
California Scents®.....	92-93
Cam Locks.....	299,404
Cameras (Security).....	463-465
Canister (Vacuum Clean Out).....	302, 312, 321

Canopies	
Vacuum Island	314
Carbon Filters	478, 476, 480
Car-Freshner®	
Counter Display Stands	85, 87
Decals	104
Little Trees®	
Carded Singles	81-82
Carded 2 Packs	83
Carded 3 Packs	83
Carded 6 Packs	83
Clip Strips	84
Retail Displays	87
X-Tra Strength	84
Little Trees® Pouch Packs	79-80
Little Trees® Vender	41-43
Fiber Can™	86
Fiber Can™ Displays	87
Pump Sprays™	86
Vending Machines	41-43, 114, 115
Vent Liquid™	85
Vent Wrap®4 Packs	85
Vent Wrap®Counter Displays	85
Car Scents™	93
CryptoPay	
Information	466-470
Retrofit Kits	469
Side Mount Box	48
Signs & Decals	437, 469
Systems & Swipers	468
CryptoTap/Plus	468
Carlo Gavazzi	553
Carpet Cleaners	
Chemicals	
Kleen-Rite	326
Kleen-Shine™	144
Retail/Detail	
Armor All®	120
Kleen-Shine™	144
Meguiar's®	130
Mothers®	133
Simoniz®	139
Sprayway®	132
Stoner	137
Carpet Fragrance	326
Carpet Shampoo	326
Car Wash Wall Panels (Extrutech)	472
Cat Pumps®	
Adjustable Injector	726
Automatics	
For Belanger®	530
For Hanna™	542
For Sonny's®	521
Barrel Dump Gun	374
Centrifugal Pumps	215
Ceramic Plunger Pumps	209
Detail Pumps	206
Drain Kits	215
Extractor Pumps	206
Guns	371
Gun Fittings	374
Guns, Pressure Wash	589
Injectors, Adjustable	726
Oil	215, 530, 542
Piston Pumps	209-210
Pressure Wash Pumps	610
Pump Breakdowns	211-214
Pulsation Dampener	530
Regulators	252
Regulating Unloaders	252, 610
Repair Kits	215
Safety Relief Valves	627
Spray Gun Fittings	374
Unloaders	252, 610
Valves	627
Cat 5 Cable	468, 745
Caution Signs	313, 749, 750, 423, 427, 435, 439, 444
Central Vac System	289-290, 311
Ceramic	
Applicator Pad	173
+Ceramic Leather Cleaner	121
CMX®	136
Coating	142, 710
Coating Towels	173
Diamond Plate Kit	142
Glow Foam®	711
Leveling Towel	173
Menu Strip	440, 694
Plunger Pumps	207-209, 530, 542
Rotor Nozzles	381
Sealant Arch	694
Signs	710
Trim Restorer	130
Ultimate Hybrid™	136

Wax	130
Weight	513, 722
Chain	498-499, 519-520, 527, 537, 539, 544
Chain Lubricant	559
Chain & Roller Chart	491
Chain Sprocket	505
Champion	475
Changers	
American Changer	
Bill Changers	270, 747
Bill to Bill Dispensers	270, 747
Cash, Coin & Card "Token" Disp.	271
Changer Parts	272
Coin Counter	284, 746
Compact Coin Counter	284, 746
Currency Counter	284
Decals/Stickers	272
Front Load Changers	271, 272
High Security Front Load	747
Hoppers	272
Multi-Bill Changer	747
Rear Load Changers	270, 747
Token Dispenser	271
Hamilton	
Bill to Bill	279
Dual Rear Load	278, 748
Economy	278, 748
Front Load	278, 748
Heavy Duty	279
Rear Load	278, 279, 748
Parts	277
Rowe	
Front Load	282
Conversion Kits	282, 283
Rear Load	282, 747
Standard	
Bill to Bill	276
Conversion Kits	276
Credit Card Token Machine	277
Parts	277
Rear Load	276, 277, 748
Retrofit Kit	277
Slim Model	277
Upgrade Kits	277
Triad	
Bill Breaker Series	747
Front Load	275, 747
Rear Load	275
Changer Parts, Kits & Cleaners	
American	272
Cleaning Kits	288
Coinco	356, 748
Hamilton	280-281
Mars	284
Pyramid	272
Rowe	282-283
Standard	276, 277
Changer Signs	433
Char-Lynn Motors	556-557
For Hanna™	537, 539, 540
For MacNeil®	543
For Ryko®	514
For Sonny's®	520
Charts	
Bollard Sizing	335, 336
Nozzle/Spray Tip	375, 376, 688
Post Guard	336
Roller & Chain	491
Tip Freeze	688
Tube Sizing	660
Check Valves	
Barbed	598, 635
Blue-White Pumps	230, 513
Brass	520, 634, 635, 636
Brass Ball	635
CVT	635
Dema	635
Diaphragm	380, 523, 529, 532, 534
Drip Free	380
Filter with	601
Fluid Controls	636
Foot	598, 635
For Belanger®	529
For MacNeil®	544
For Motor City Wash Works®	532, 534
For Ryko®	513
For Sonny's®	520, 521, 523
High Pressure	520, 636
Inline	598, 635, 636
Inline Chemical	636
John Guest®	646
Kit for Flojet	235-238
Kleen-Rite	634, 635
Maxi-Flow	628
Low Pressure	634

Parker	635, 636
Polypropylene	230, 634
Poly Tube	646
Pressure Wash	598
Pulsatron Injection	229
PVC	598, 634, 635
Regular	380
Replacement Kit (Water Driven Pump)	731
Specialty Mfg. Co.	634, 635, 636
Split Eyelet (with)	532, 534
Spraying Systems Co.®	379, 380, 532
Stainless Steel	547, 634, 636
Strainer (with)	379, 529
Teejet (with)	529
Teflon	547
U.S. Para Plate	635, 636
Value Line	634
With Check Strainer	379, 529
With Viton Seals	544
Chemical Injectors	
Adjustable	613, 726
Adjustable Siphon	726
BE Pressure	615
Brass	726, 727
CAT Pumps®	610
Chem-Flex™	724
Composite	724, 725
CPVC	727
Dema	728, 729
Fixed	610, 613, 726
General Pump®	547, 726, 727
Giant Industries	726
High Pressure	615
Hydra-Flex	724-725
Low Pressure	615
Quick Connect	725
Rocket (Dema)	729
Spraying Systems Co.®	726
Stainless Steel	726, 727
Suttner	726
Unloader with	605
Upstream	615
Versadial™	725
X-Jet	613, 727
Chemicals	
Amazing Glow Foam®	687, 711
AP Formulators	
Brick Renew	714
Klean Wall	472, 714
Klean Wall II	472, 714
Pit Enzyme	486, 715
Armor All®	142
Bug Remover	
Bug Master	682
Bugsaw	709
Don't Bug Me	685
JBS Industries®	709
Kleen-Pak	689
Kleen-Rite	682
National Automotive Chemical	707
Shore Corporation	712-714
Simoniz®	685
Detailing	
Armor All®	142
Kleen-Shine™	143-146
Lexol®	156
Meguiar's®	151-154
Mothers®	149-150
Simoniz®	142, 146-148, 156
Dog Wash	453, 455, 456, 686
Glow Foam	687, 711
Green Scene	703
Hot Wax & Shine	452, 474, 693
JBS Industries®	
Amazing Glow Foam®	687, 711
Automatic	710
Glow Foam	687, 711
Self-Serve Concentrate	709
Specialty Products	709
Triple Foam	679, 687, 688
Winter Anti-Freeze	688
Kleen-Pak	676, 689
Kleen-Rite	
All-Systems	678
Automatic Detergents	682
Bug Master	682
Bug Remover	682
Dog Wash	453, 455, 456, 686
In-Bay Presoak	678
Kleen-Pak	676, 689
Kleen-Track	680-681
Kleen Tunnel	682
Powders	682
Self-Serve Ultra Concentrate	677

Triple Foam.....	679, 687, 688
Wheel & Tire.....	679
Winter Anti-Freeze.....	688
Kleen-Track.....	680-681
Kleen Tunnel.....	682
Laundry.....	698, 742
National Automotive Chemical	
It Works.....	474, 714
Plus Products.....	707
Premium Products.....	708
Powder.....	708
Tire Cleaner.....	708
Triple Foam.....	707, 708
Wall Cleaner.....	474
Maintenance.....	714, 715
Pit Deodorizers.....	486, 715
Powders.....	679, 682, 698-700, 708
Powders (Laundry).....	698, 742, 744
Pressure Wash.....	614, 615, 700
Reclaim.....	702
Sanitizer.....	146, 741
Shore Corp.....	712-714
Simoniz®	
Additives.....	697
Bug Remover.....	685
Ceramic Sealant & Arch.....	694
Detail.....	142, 147-148
DeSalt.....	685
Green Scene.....	703
Hot Wax & Shine.....	452, 474, 693
High Performance.....	701
Hyper Pak Concentrates.....	692
Kleer Kote Super Concentrates.....	693
Laundry.....	698, 738, 742-744
Maintenance.....	715
Pad Perfect.....	683, 684, 701
Pressure Wash.....	614, 615, 700
Powders.....	679, 698-700, 708
Prime Pak.....	690
Reclaim.....	702
Sanitizing.....	146, 741
Specialty.....	700
Spray Shine & Polishes.....	697
Tire Shine.....	684
Touchless & Cloth Automatic.....	696
Triple Foam.....	690, 697, 701, 702
Wax.....	152-154, 452, 474, 693
Whitewall & Wheel Cleaners.....	679
Winter Anti-Freeze.....	688
TransMate™	
Drying Agents.....	704
In-Bay Friction.....	704
Sealers/Polishes.....	704
Tire Dressing.....	705
Tunnel Body.....	704
Tunnel Presoak.....	707
Vivid Self-Serve.....	706
Wheel Cleaners.....	705
Triple Foam.....	687, 690, 701-703
Triple Foam (low pH).....	687
Wax	
National.....	708
Shore Corporation.....	712
Simoniz®.....	692, 693, 697
Trans-Mate™.....	706
Whitewall, Wheel & Tire Cleaners	
Kleen-Pak.....	689
Kleen-Rite.....	677-679
Kleen-Shine™.....	144-146
Meguiar's®.....	151, 152
Mothers®.....	149
National.....	708
Shore Corporation.....	713
Simoniz®.....	690, 692, 693, 698, 701-703
Winter Anti-Freeze Detergent.....	688
Winter Triple Foam.....	688
Chemstick.....	231
Chinrose® Locks.....	406
Circuit Breakers (Resettable).....	413
Citrus Magic® Air Fresheners.....	101
Clamps	
Cush-A-Clamp®	
Assemblies.....	673
For Motor City®.....	532
For Sonny's®.....	521
Cush-A-Claw®.....	674
Cush-A-Clip®.....	673
Cush-A-Nator®.....	673
Hose.....	651, 674
Mat.....	393
Ring.....	722
Pipe.....	502
Strut Mounted.....	674
Surface Mounted.....	674
Clamp-Style Rotary Vane Pump.....	233-234
Cleaning Cards & Accessories.....	288

Clean Out Bags.....	302, 321
Cleaners and Lubricants.....	407, 414, 559
Clearance Bar/Structures.....	334
Cleveland Float Valves.....	632
Clip-Eyelet Nozzle.....	381
Cloth Replacement (Automatic)	
Autec®.....	582
Belanger®.....	531, 569, 570
Econocraft™.....	571, 579
Hanna™.....	572-573
Sonny's®.....	575-577, 580
Peco®.....	577, 579
Cog Belts.....	507
Coil Tubing.....	390, 666
Coilhose Pneumatics.....	265, 309
Coin Acceptors	
Coin Mechanism.....	358
European Rejector.....	359
GinSan.....	51, 357
Greenwald.....	359
IDX.....	359
Imonex.....	358
(for) Laurel Venders.....	46
Parker Engineering.....	357
MA-850.....	46, 359
Magikist.....	360
Microcoin.....	360
Multitron.....	357
SecureCoin.....	360
Sensortron.....	51, 357
Slugbuster®.....	357
X-Mark Xeptor®.....	359
Coin Boxes	
J.E. Adams.....	412
Kleen-Rite.....	411
Coin Box	
Cable Ties.....	413
Connectors.....	409
Control Wire.....	409
Decals.....	441-444
Electrical Accessories.....	408-409, 413
Faceplate.....	412
Heaters.....	413
Heat Tape.....	413
Knobs.....	409
Locks.....	404-406
Lock Bars.....	407
Parts.....	407-409, 413
Pilot Lights.....	409
Resettable Breakers.....	413
Rotary Switches.....	409
Rotary Parts.....	408-409
Safes.....	407
Terminal Strips.....	409
Thermostats.....	413
Transformers.....	413
Coin & Currency Counters	
American.....	284, 746
Hitachi.....	284, 746
Klopp.....	285, 286
Paycomplete.....	284
Scan Coin.....	284, 286
Conversion Kits.....	276, 748
Coinco	
Add On Box.....	412
Bill Acceptor with Flexstack.....	56, 273, 355
Vantage Series.....	274, 356
Coin Chute (Greenwald).....	359, 746
Coin Counter (Impulse).....	359
Coin Counting Scales.....	286
Coin Cup.....	51
Coin Cup Motor Assembly.....	46
Coin Hopper.....	51, 274, 356
Coin Insert.....	47, 358
Coin Safe.....	407
Coin Sorters	
Klopp.....	285
Scan Coin.....	286
Comet	
Nozzle Protectors.....	385, 522
Pumps.....	229, 607
Pressure Cleaning Pumps.....	607
Compressor (Blow Gun).....	309
Compressors	
Assembly.....	301, 309
Champion.....	475
Gast.....	309
Contactors	
Allen Bradley.....	268
For Ryko®.....	512
Overload Protector.....	268, 512
Hartland Controls.....	268
Connectors	
Alpha Technologies.....	652
Brass.....	647, 654, 659
Brass & Nickel Plates.....	654

Din.....	621, 624
For DVR Security Systems.....	464
Hydraulic.....	660
Kleen-Rite.....	654
JIC.....	660
John Guest®.....	646, 647
Nickel-Plated.....	652
Parker	
Fast & Tite.....	659
True Seal.....	650
Phoenix.....	409
Plate (Bucket).....	157
Poly-Tube.....	652
SMC®.....	648-649
Union.....	646, 650, 652, 653, 654, 659
Continental	
Belts.....	269
Hose.....	604, 605, 670-672
Pressure Wash.....	604, 605
V-Belt.....	269
Control Wire.....	409
Counters	
Coin & Currency.....	284-285, 746
Hour Meter.....	267
Impulse Coin.....	359
Courtesy Towels.....	26, 28, 30, 39
Covers	
Seat.....	164
Steering Wheel.....	164
Windshield Wiper.....	164
Coxreels.....	603
Crevice Tool.....	318
Crimper Machine.....	661
Credit Card Acceptance	
CryptoPay.....	466-471
IDX.....	471
Monex.....	471
Nayax.....	470
Credit Card Reader Cleaner.....	288
Crimper	
Crimp.....	661
Crimp Fittings.....	661, 662
Swage Fittings.....	663
Crimper Machine.....	661
Swaging Crimper.....	655
CryptoPay	
Signs & Decals.....	469
Systems.....	466-471
Cuffs	
Flash.....	316
Swivel.....	316, 317
Upholstery.....	317
Currency (Bill) Counters/Sorters	
American.....	284, 746
iHunter.....	284
Klopp.....	285-286
Scan Coin.....	284
Cush-A-Clamp®.....	673
Cush-A-Claw®.....	674
Cush-A-Clip®.....	673
Cush-A-Nator®.....	673
Custom Air Fresheners.....	CALL/16
Custom Fresheners.....	101
Cyclo®	
Accessories.....	194
Polisher.....	194
D	
D&S® Replacement Parts.....	687
Dampeners-Pulsation	
For Belanger® Vector Rapid Wash™.....	530
For CAT Pumps®.....	215, 521, 530
For Pentair Hypro®.....	221
For Sonny's® Pressure Gun Units.....	521
Hose.....	221
Danfoss	
Solenoids.....	625
Solenoid Coil.....	547
Valves.....	547, 562, 625
Decals	
Coin Box.....	441-444
Laundry.....	751
Pet Wash.....	445
Price.....	442-444
Rotary.....	441
Vacuum/Air.....	302, 304-305, 309, 311, 313
Vending.....	50, 104-113
Deodorizer.....	145, 156, 715
Dema	
Aqua Master.....	723
Check Valves.....	635
Diaphragm Valves.....	617
Float Valves.....	723
Junction Box For Hanna™.....	542

Injectors					
B Series	728				
C Series	728				
for Belanger®	528				
Rocket	729				
Manifold Blocks	616				
Metering Tip Kit	728				
MixRite	730				
Portable Foamers	184				
Proportioners	730				
Rocket (Injector)	729				
Solenoids	616-619				
Solenoids (Automatic Replacement)					
Hanna™	541, 542				
Strainers	266, 598, 635				
Wall Mounted Foaming Units	184				
Detailing Supplies					
Air Activators	205				
Al-Brite™	685				
Aprons	163				
Applicator Bottles	150, 158				
Applicator Brush	179				
Applicator (Dress Pro)	186				
Applicator Pad	160, 173, 175				
Armor All®	122-124, 142				
Bottles	158				
Boots	162				
Boot Covers	162				
Brushes	177-181				
Buckets	716				
Bucket Dolly	157				
Buff & Shine	187				
Carts & Caddies	157-158, 166-167				
Carpet Adhesive Film	164				
Ceramic Coating	142				
Chamois	175				
Clay	160				
Collapsible Carts	167				
Collapsible Cones	333				
Cones	162, 334				
Cyclo® Polishers	194				
Deodorizers & Fragrance	145, 156				
Diamond Plate	142				
Disinfectants & Sanitizers	146				
Disposable Floor Mats	164				
Dressing Applicators	160, 173, 175				
Ear Protection	163				
Emulsifier (Towel)	174				
Eye Protection	163				
Extractors					
KleenRite® Mfg. Extractors	204				
Mytee®	196-201				
Thresher®/Diamond Lustre	203				
Extractor Deodorizer	145				
Extractor Pumps	206				
Foamers	184-185				
Flex®	190-193				
Floor Covers	164				
Funnels	159				
Gloves	161				
Grit Guard®	157				
Hand Tools/Scrapers	177				
Hearing Protection	163				
Kits	155				
KleenRite® Mfg. Extractors	204				
Kleen-Shine	143-146				
Leather Care					
Kleen-Shine™	145				
Meguiar's®	152				
Simoniz®	147				
Stoner Car Care®	155				
Lexol®	156				
Lilly Brush	177				
Markers/Pens	160				
Meguiar's®					
Applicator Pads	160				
Carts	167				
Chemicals	151-154				
Clay	160				
Polisher	195				
Mothers®	149-150				
Mytee®	196-201				
Odor Eliminators	156, 205, 742				
Ozone Machines	205				
Pad Cleaning Tools	157, 159				
Pail Opener	159				
Paint Correction	165				
Pet Hair Removal Tools	177				
Polishers/Bufferers					
Cyclo®	194				
Flex®	190-193				
Meguiar's®	195				
Rupes®USA, Inc.	188-189				
Pumps	206				
Rupes®USA, Inc.	188-189				
Safety Cones	162				
Safety Glasses/Shields	163				
Sanitizers & Disinfectant	146, 742				
Scrapers & Blades	177				
Seat Covers	164				
Simoniz®	142, 147-148				
Simoniz® Diamond Plate	142				
Spray Bottles	158				
Spray Paint	165				
Sponges	175-176				
Steamers	202				
Steering Wheel Covers	164				
Steel Wool/Abrasives	165				
Stoner Car Care®	137-138				
Tire Shine Applicators	160				
Towels	169-176				
Towels By Doctor Joe®					
Ceramic Coating	173				
Courtesy	171				
Detail	170-174				
Emulsifier	174				
Tornador®	183				
Wash Mitts	176				
Water Nozzles	159				
Windshield Wiper Bags	164				
Detergent Dispensers	741				
Deublin® Swivels					
For Hydro-Spray	637				
General	640				
Diamond Cut Compound	153				
Diamond Glass Towel	33				
Diamond H2O	478				
Diamond Lustre	203				
Diamond Plate	142				
Diaphragm					
Check Valve					
Belanger®	529				
Motor City®	532, 534				
Sonny's®	523				
Hydrominder Repair Kit	722				
Pressure Regulating Valve	257				
Repair Kit-Ryko®	512				
Replacement-Belanger®	521				
Valves	612				
Diaphragm Pumps					
Aro	242				
Aquatec	251				
Etatron	231				
Flojet	235-238				
Graco® Husky	250				
Pentair Shurflo®	246-247				
Sandpiper®	244				
Versamatic®	245				
Yamada®	248-249				
Die And Pusher	668				
Digital Timers					
Big Time	364				
Dixmor	367-368				
GinSan®	364				
LED6	368				
LED7	368				
LED9	367				
IDX	364				
Timemaster	360				
Diskin Systems, Inc.	449-450				
Disposable Floor Mats	164				
Dixmor					
Timer	367-368				
Weep Mizer	460				
Dog/Pet Wash					
Chemicals	453				
Decals	455, 456, 458				
Parts	457				
Signs	455-456				
Packages	453-454				
Vending	458				
Dole Valve	625				
Doors (Clearview)					
Bay Doors	473				
Door Gaskets (Vac)298, 299, 300, 302, 322, 323, 324					
Dosatron®					
Chemical Proportioner	733-734				
For Motor City Wash Works®	535				
Low Pressure Panels	734				
Proportioner	733-734				
Double Groove Bushing	269				
Double Lance Wand	386, 592				
Drain Cleaning Nozzle	375, 601				
Drain Valves					
Electronic Automatic	475				
For Mytee®	196-197				
Dralco					
Mat Cleaners	488				
Matwacker	488				
Rug Beater	488				
Stainless Steel Sink	369				
Driveway Bell Hose	403, 514				
Drum Dolly	740				
Drum Pumps					
Beckson Hand Pump	718				
Chemstick	231				
Graco® Husky Drum Pump	250, 718				
Graco® Husky Fast-Flo	250, 718				
New Zealand	718				
Syphon Pump	718				
Drum Wrench	718				
Dryers & Dryer Parts					
Air Shammee	449-450				
Auto Dry/Air Logic	451				
Desiccant	265				
Flojet Extractor Dryer	265				
J.E. Adams	451				
Proto-Vest (Automatic)	566				
Turbo Towel	451				
Drying Agents					
Harold's Choice	675				
JBS Industries®	709, 711				
Kleen-Rite	679, 689				
Kleen-Pak	689				
Kleen-Tunnel	682				
National Automotive	707-708				
Shore Corporation	712-713				
Simoniz®	690, 696				
Trans-Mate™	704				
Dual Arch System	289				
Dual Inlet Valve	625				
Dual Prep Gun Unit	462				
Dual Vacuum	297				
Dualer	319				
DVR Security Systems	463-465				
Dwyer Flowmeter	716				
E					
Etatron	231				
Ear Muffs	163				
Ear Plugs	163				
Easy Heat	459				
Elbows					
Alpha	652				
Banjo	651				
Barstock	657, 658				
Brass	647, 654				
Female	659				
Fixed	646, 650, 652, 654				
For Ryko®	509, 511, 513				
For Sonny's®	520, 524, 525				
John Guest®	646, 647				
Kleen-Rite	654				
Male Flare	658				
Nickel-Plated	652				
Nut/Sleeve	659				
Parker®	650, 659				
Pex	647				
Poly Tube	646, 652, 654				
Push Lock	652, 656				
Reducing	646, 650				
SAE	658				
SMC®	648-649				
Stainless	653				
Street	651, 653				
Swivel	646, 647, 650				

GinSan®	357
IDX	359
Imonex	358
(for) Laurel Venders	46
Parker Engineering	357
MA-850	359
Microcoin	360
Multitron	357
SecureCoin	360
Sensortron	357
Slugbuster®	357
X-Mark Xeptor®	359
Electronic Vender	
Kleen-Vend	51
Kleen-Vend Parts	51
Kleen-View	50
Kleen-View Parts	50
Laurel	40-44
Laurel Electronic Parts	46-49
Mega-Vendor	52-54
Raddatz	57
Electros witch	408
Emperor Pump Stand	464
Emperor Series Pumps	216-217
Emulsifier	29, 741
Erie Brush®	
Detail	178-179
Foammaster®	398-399
Handle Scrubbers	178
Hogs Hair	178-179, 398-400
Replacement Parts	399
Round Foammaster®	399
Rubber Bumper	399
Spoke Brushes	179, 400
Super Nozzle Holder	392
Synthetic	398, 400
Triple Surface	400
Truck	399
Vacuum Bag Brush	321
Vac Nozzles	318
Wall Holder	392
Wheel Wizard®	400
Wheel Wonder®	567
EverWash	14-15
Exit Sign	434
Expansion Tanks	264
Express Blend Center	148
Express Wax	147
Extractors	
KleenRite®Mfg.	204
Mytee®	196-201
Thresher®	203
Extractor Dryer (Flojet)	265
Extrutech Wall Panels	472
EZ-Grate Fiberglass Car Wash Grating	486
EZ Heat Pipe Heat	459

F	
Faceplates	298, 303, 412
Faceplate Decals	305
Febreze®	
Air Fresheners	54, 55, 98
Fabric Refresher	98
Vent Clips	98
Festoon	547
Fiberglass Grate Plugs	486
First Aid Kits	741
Filmtec Membranes	479
Filters	
Carbon	478, 480
Intake	266
Micron	480
Regulator Filter	263, 504
Sediment	480
Filter Bags	312, 321
Fittings	
Banjo	651-652
Barstock	657-658
Brass	647-648, 654-659
Break Away	374
Chart	660
Crimp	661
Fast & Tite	659
Garden Hose Kit	606
Hose (Adapter)	655
Hose (Foamy)	370, 390, 667
Hydraulic	660-663, 668
John Guest®	646-647
Karcher	597
Kleen-Rite	654, 661
Nickel Plated	652
Nut/Sleeve	659
Parker®	650, 659, 661-662
Poly Tube	646, 652, 654
Push Lock	656

Quick Connect	598
Reusable	661, 668
SMC®	648-649
Spray Gun	374
Stainless Steel	653
True Seal	650
Flags	419-420, 750
Flag Poles	419-420
Flex Couplings	499, 539
Flex® Polisher	190-193
Flint & Walling®	240
Floats	629-633
Floats Valves	
Aqua Master	723
Bob®(Roberts)	629
Casa	629
Cleveland	632
Copper	629
High Temp	630-633
Hudson	633
Hydrominder	719-722
Jobe™	630-631
Suttner	633
Walters	632
Watts	633
Float Switch	201, 480
Flojet	
Extractor/Dryer	265
For Hanna™	541
For Motor City Wash Works®	533, 535
For Sonny's®	525
Kits	235-238
Parts	235-238
Polytube Fitting	
For Hanna™	541
For Motor City®	535
For Sonny's®	520, 524-525
Pumps (Detail)	206
Pumps	235-238
FloodJet® Nozzles	378
For Motor City®	534
For Sonny's®	521
Floor Displays	
Armor All®	119
Citrus Magic®	101
Floor Heat	
Anti-Freeze	484
Floor Mats	
Disposable	164
Superhero	141
Simoniz Sets	140
Floor Mat Clamp	393
Floor Mat Cleaners	488
Floor Mat Cleaning Products	122, 137, 144, 146
Floor Switch	
Recora®	554
Tapeswitch®	555
For Hydro-Spray	507
For Motor City®	532
For Sonny's®	516
Flowmeter	
Dwyer	716
Panel Mount	716
Flow Switches	267
Fluid Controls	
Ball Bearing Swivel	637
Boom Swivel	639-640, 644
Check Valves	547, 636
Pop-Off Valves	627
Metering Valves	628
Swivels	637, 640
Fluid-O-Tech	234
Foam Gun	
Guns	374, 687
Holder	391, 687
Parts	374
FoamJet® Nozzle	378
Foam Generator	
Fragmatics®	324
Hydro-Spray	461, 506
New Wave	561
TSS	561
Foamers	
Hand-Held	183, 185
Portable	184
Wall Mounted	184
Foamer Head	506
Foamer Parts	
Sonny's®	521
Foamy Brushes	
BoarTex	395, 397
Erie	398-399
Hog Daddy	370, 401
Hogs Hair	370, 393-395, 398-399
Hog King	401
InkFish®	401

Kleen-Rite	370, 401
Mosmatic	393
Synthetic	394-395, 398-399
Universal	394-395
Value Line	402
Foamy Brush	
Bucket	392
Handles	389
Holders	392
Hose Assembly	370, 390, 667
Hose	666-667, 672
Kit	370
Foot Valves	598, 635, 722
For Blue-White Pumps®	230
For Hydrominder	720, 722
For Motor City Wash Works®	533
For Pressure Wash	598
For Ryko®	513
General Pump®	608
Foot Valve (Industrial)	608
Foot Valve Weight	722
Fragrances	
Arm & Hammer™	99
Axe	89
Cans	86-89, 92-93
California Scents®	92-93
Car-Freshner®	79-87
Driven™	88
Fragmatics®	326
Gels	88-89, 99
Kleen Scent	326
Little Trees® in a Can	86-87
Sprays	76, 86, 91-92, 97-98, 101-102, 120
Fragrance Machines & Parts	
Fragmatics®	323-325
J.E. Adams	294, 301, 310
Freeze-Free Cable	459
Freeze Prevention/Heaters	459-460, 481-484
Funnels	
Coin	407
Detail	159
Furnas Pressure Switch	264
Fuses	
Fragmatics®	323-325
Holder	301, 322
J.E. Adams	322
Transformer	413
G	
GC Valves	620-621
G&G Lighting	345-349
Garden Hose Fittings	606
Garden Hose Kit	606
Gas Cans	587
Gaskets	
Door	298, 299, 301, 302, 322-325
For CAP10-20 Adapter Cap	529, 532, 534
QuickJet®	380
Showerhead	457
Strainer	266
Trigetjet®	384
Vac Motor	203, 298, 299, 301, 327, 465
Vac Motor Check	329
Gasketmaker	414
Gates Hose	
Clean Master®	672
Hydraulic	668
Plant Master	672
Pressure Wash	672
Gauges	267, 329, 513, 522, 542
Gauge (Fuel Level)	483
Gauge (Tire Inflator)	309
Gavazzi, Carlo	553
Gem Locks	404
General Pump®	
Adjustable Nozzles	599
Balanced Relief Valve	612
Ball Valve	628
Chemical Filters	601
Chemical Injectors	547, 726, 727
Clear Bowl Strainer	265, 601
Drain Cleaning Nozzle	375, 601
Double Lance	386, 592
Emperor Series Pumps	216-217
Flow Switch	267
Foam Lance	185
Foot Valve	608
Guns	589
Gun/Lance Combos	589
Gutter Cleaning Assemblies	595
Hammerhead	591
Hose Reels	602
Hose Reel Cart	602
Industrial Foot Valve	608
Injectors	547, 726, 727

In-Line Filter.....	601
Inlet Filters.....	601
Kits.....	221
Nozzles	
For Belanger®.....	529
For Pressure Cleaning.....	599
Packs.....	597
Lances/Wands.....	591, 592
Oil.....	219
Pressure Cleaning Pumps.....	608
Pumps.....	216-219
Pump Breakdowns.....	220
Quick Connect Spray Tips.....	597
Regulating Valve.....	253
Relief Valve.....	612
Rotating Nozzles.....	599
Spray Tips.....	375
For Hanna™.....	543
Quick Connect.....	375
Strainers.....	265, 601
Steam Nozzle.....	601
Surface Cleaner.....	591
Telescoping Wand.....	591
Thermal Protector Relief Valve.....	608
Trailer Mount Hose Reel.....	602
Trapped Pressure Unloader	
For Hanna™.....	542
Trikleener®.....	591
Unloaders.....	254, 257, 606
Vector Nozzle Bundle.....	529
Wall Mount Hose Reel.....	602
Water Broom.....	591
Giant Industries	
Accumulator.....	223
Guns.....	371, 589
Injectors.....	726
Moistwipe.....	74
Nozzles.....	381, 600
Oil.....	223
Pop-Off Valve.....	627
Pressure Cleaning Pumps.....	607
Pressure Wash Guns.....	589
Pumps.....	222-223
Regulators.....	259
Relief Valve.....	259
Thermal Relief Valves.....	223
Towels.....	74
Turbo Nozzle.....	382, 600
Unloaders.....	259, 612
For Sonny's®.....	522
Valves.....	627
GinSan®	
Audible Alert Kit.....	363
Buzzer Last Alert.....	363
Clean Out Bag.....	312, 321
Coin Acceptors.....	51, 312, 357
Coin Box Heater.....	413
Coin Box Thermostat.....	413
Display Timers.....	364
IVS.....	311-313
Multitron.....	357
Nozzle Protectors.....	385
RO System.....	476
Sensortron.....	51, 312, 357
Signs.....	438
Timers.....	362-363
Water Softener.....	476
Gloves.....	161
Golden Gate	
Foamy Handle.....	384, 389
Wands.....	384, 388, 389
Gould Pumps.....	241
Grace Timer.....	361
Graco® Husky Pumps	
Pumps.....	250
Drum Pumps.....	255, 718
Graffiti Remover.....	139
Grate Plugs.....	486
Grease Fittings.....	501
For Hanna™.....	540
Greenwald	
Coin Acceptors.....	359, 746
Key.....	404, 746
Locks.....	404
Money Box.....	746
Vertical Chute.....	359, 746
Grit Guard®.....	157
Guns	
Cat Pumps®.....	371, 374, 589
For Fragrance Machines.....	323, 325
Dump.....	374
Fittings.....	374
General Pump®.....	589
Giant.....	371, 589
Guards.....	374
Holder.....	374, 392

J.E. Adams.....	372, 373, 589
Kits.....	370, 588
Kleen-Rite.....	370, 371, 374, 588
Mecline.....	372, 522, 589
Pressure Wash.....	588-589
Spraying Systems.....	373
Suttner.....	372, 373, 588
Swivels.....	639
Triple Foam.....	374, 687
U.S. Paraplate.....	371
Veloci (Formerly MTM Hydro).....	372, 589
H	
Hamel Manufacturing Co.	
Clean Out Canister.....	321
Flex Wand™.....	388
Foam Brush Bucket.....	392
Foam Handles.....	389
Holder.....	392
J-Hook.....	392
Mat Clamps.....	393
Nozzle Protectors.....	374, 385, 687
Tip Twister®.....	375
Triple Foam	
Gun.....	374, 687
Nozzles.....	374, 687
Nozzle Protectors.....	374, 687
Parts.....	374, 687
Wands.....	386-388
Wand Holders.....	391, 687
Hamilton Changers	
Changers.....	278, 279, 740
Changer Parts.....	280-281
Hand Protection.....	161
Hand Pumps.....	718
Handle Holders.....	391
Handles	
Foam Brush.....	389
Wobblehead.....	391
Wood.....	182, 403
Hand Sprayers.....	158, 183, 186
Handwringer, Lake City.....	369
Handwringer Sink.....	369
Harper® Brush	
Brooms.....	182
Bi-Level Brush.....	402
Corn Whisk.....	181
Detail Brushes.....	179, 180
Gong Brushes.....	180
Handles.....	182, 403
Prep Brushes.....	402
Push/Outdoor Brushes.....	182
Shop Brushes/Scoops.....	181
Squeegees.....	181
Wash Brushes.....	402
Hartland Controls.....	268
Headlight	
Lens Restorer.....	124
Renewal Kit.....	133
Headgear.....	163
Heat Tape.....	413
Heaters	
Baywatch.....	481
Boiler.....	482
Easy Heat Pipe Heating.....	459
Electric.....	483
Floor Heat.....	484
Gas.....	481-484
Portable.....	481-484
Radiant (Ceiling).....	481
Radiant Heat Tubing.....	481
Radiant Tube.....	481
Water.....	482
Hooks.....	392
Hose	
Anchor.....	403
Bell.....	403
BE Pressure.....	604
Clean Master®.....	672
Cleanstream™.....	604, 670
Clear PVC.....	665
Clear Vinyl.....	533, 547, 669
Continental	
Extended Life HYD.....	671
Pliovic®.....	672
Pressure Wash.....	604-606
Rubber Fiber Braid.....	666
Wire Braid.....	604, 671
Foamy Hose.....	390, 666
Gates.....	668, 672
Guards.....	663
Hot Clean.....	605
Hydra-Flex.....	606
Hydraulic.....	668
Insta Grip™.....	672

Kleen-Rite.....	604, 666, 669
Kobrajet.....	605
MTM Hydro (Veloci).....	604
Non-Reinforced.....	669
Nylon Polytubing.....	666
Plant Master.....	672
Polybraid.....	669
Polyflex.....	390, 667
Poly Tube.....	666
Polyspring.....	669
Polywire.....	669
Pressure Wash.....	604-606
ProPulse®.....	604, 666
Reinforced.....	669
Rubber Fiber.....	671
Sewer.....	605
Splicer.....	403
Tough Cover.....	666
Triple Foam.....	666
Uberflex™.....	600
Vacuum.....	319, 320
Hose Adapters	
General.....	646-663
Vacuum.....	316, 317
Hose Assemblies	
Air.....	309
Coil Tubing.....	390, 666
Comfort.....	667
Foamy.....	390, 666, 667
For PDS Sprayer.....	187
Fragramatics®.....	323-325
Gun & Hose.....	301
Pet Dryer.....	457
Pet Wash Shower.....	457
Power Wash.....	604-606
Wirebraid.....	605, 670
Hose Clamps.....	651, 673
Hose Fittings	
Banjo.....	651
Barstock.....	657-658
Brass.....	653, 654
Break Away.....	374
Chart.....	660
Crimp.....	661
Fast & Tite.....	659
Garden Hose.....	606
Hose (Adapter).....	655
Hose (Foamy).....	350, 660
Hydraulic.....	659, 606, 668
John Guest®.....	646
Karcher.....	597
Kleen-Rite.....	654, 661
Nickel Plated.....	654
Nut/Sleeve.....	659
Parker®.....	650, 659, 667
Poly Tube.....	646, 652, 654
Push Lock.....	652, 656
Quick Connect.....	597, 598
Reusable.....	661, 668
SMC®.....	648, 649
Spray Gun.....	374
Stainless Steel.....	649, 653
True Seal.....	650
Hose Guards	
Nylon.....	663
PVC.....	663
Spiral.....	663
Spring.....	663
Superballs.....	606
Hose Hooks.....	392
Hose Reels	
Coxreels.....	603
General Pump®.....	602
Steel Eagle.....	603
Veloci (MTM Hydro).....	603
Hose Reel Swivels.....	606
Hose-Vacuum.....	316, 317
Hot Water Heaters, Infiniti®.....	481
Hot Wax & Shine	
Chemicals.....	452, 474
Decals.....	452
Equipment Arch.....	474
Hour Meters.....	267
Hudson Float Valves.....	633
Hubbell Lights & Parts.....	340, 353, 354
Husky Drum Pump.....	250, 718
Hydra-Cell	
For Hanna™.....	543
For Motor City Wash Works®.....	535
For Sonny's®.....	521
Oil.....	224, 535
Pumps.....	225-226
Regulators.....	260
Hydra-Flex	
Adapters.....	383
Aqua-Rocket™.....	383

Blast-Force™	383
Blast-Tec™	383
Chem-Flex™	724
Hose	606
Hot/Cold High Pressure Hose	606
Injectors	724, 725
Versadial™	725
Nozzles	383
Hydraulic	
Adapters	660
Die	668
Fluid	269
Hose	668
Hose Fittings	663
Motors	
For Belanger®	527
For Hanna™	537, 539, 540, 543
For Motor City®	532, 536
For Ryko®	510, 511, 514, 516
For Sonny's®	520-526
Pusher	668
Swage Fittings	663

Hydrominder	
Accessories & Parts	719-722
For Hanna™	541
For Motor City Wash Works®	533
For Sonny's®	522
Repair Kits & Parts	719-722
Tip Freeze Chart	688
Hydro-Spray	
Anti-Freeze System (Subzero)	459
Automatic Parts	502-508
Decals & Signs	507
Foam Generator	461, 506
RGB Guide Lites	508
Towers/Tower Parts	504, 505
Underbody Cleaning System	447
Hydro Systems	
Adjustable Water Driven Pump/Parts	731
Detergent Dispenser	741
Foamer	185
Hydrominders	719
Hydrominder Parts	720-723
Injectors	731, 732
Minidos	732
Proportioners	731, 732
Superdos	732
Twist II Clean	732

Hydro	
High Flow Valves/Regulators	255
Oil	221
Pulse Hose	221
Regulators	255
Hydranautics	
	479

I	
IDX	
Coin Acceptors	359
Credit Card Systems	471
Programmer	365
Timers	361, 365
iHunter	284
IFM Effector	553
IMI Kip Solenoids	623
IMI Norgren®	622, 623
Imonex Coin Acceptors	
For J.E. Adams Vacs	298, 299, 302
General Acceptors	357, 380
Impulse Counters	359
Industrial Chemicals	700
Industrial Foot Valve	608
Industrial Turbo Nozzle	383
Inflatables	422
Injectors	

Adjustable	726
Adjustable Siphon	726
BE Pressure	615
CAT Pumps®	726
Chem-Flex™	724
Dema	528, 728, 730
Dosatron	733, 734
Fixed	726, 727
Foam	185
Foamer Lance	185
For Belanger®	528
For Hanna™	541
General Pump®	185, 726, 727
Giant	726
High Pressure	185, 615
Hydra-Flex	724, 725
Hydro Systems	731, 732
Low Pressure	615, 734
Proportional Injectors	731, 732
Rocket (Dema)	729
Spraying Systems	726

Suttner	726
Versadial™	725
X-Jet	727
Injector Cleaner	126
Inserts	
Bearing	500, 539
Button	51
Canadian/US Coin	358
CM	358
Coin	47, 285, 358
Coin Plate	47
Disc	285
Fittings	647
Foam Generator	561
Grit Guard®	157
Imonex	358
Sign	425, 428
US Coin	47, 358
Instructional Signs	
Automatic	429-430
Bay/General	432-440
Laundry/Janitorial	749, 750
Vacuum	444
Insulated Lance	386
IVS	

Air Machine	311
Arch System	311
Clean Out Bags	312, 321
Decals	312-313
Door Gasket	322
Latches	322
Mini Power Vac	311
Motor Gaskets	322
Parts	312
Power Vac	312-313
Vac	311, 313
Vac/Air	312
Vac/Shampoo	313
Invisible Glass®	144

J	
J Hook	392
JBS Industries®	
Amazing Glow Foam®	711
Automatic	710
Self-Serve Power Concentrate	709
Specialty Car Wash Products	709
Titration Kit	717
Triple Foam	687
Winter Anti-Freeze	688
J.E. Adams	

Air Dryer	293, 451
Air Machine	306-308
Air Machine Parts	309
Arch System	289-291
Breakdowns	298-300
Canopies	314
Central Vac System	289-291
Clean Out Bags/Canisters	302, 321
Coin Box	304, 412
Coin Box Faceplate	303, 412
Combo Machines	
Air/Vac	296, 297
Air/Water	308
Air/Water/Vac	306
Fragrance/Vac	294, 297
Hot Air Dryer/Vac	293
Shampoo/Spot Remover	294, 297
Shampoo/Vac/Fragr./Spot/Air	294
Tire Shine/Vac	293
Commercial Vac	287
Decals	302, 304, 305
Dome Mounting Kit	304
Dryers	293, 451
Dual Vac	297
Fragrance Machines	310
Fuses	323
Guns	372, 373, 589
Gun Fittings	374
Hose Reel Swivel	606, 631
Intake Filter	266
Lances	387, 592
Lock Bars	304
Mounted Vacs	290
Motor Gaskets	325
Nozzle Protector	385
Parts & Accessories	298-305
Pressure Wash Guns	589
Regulator	252
Safety Relief Valve	627
Security Kit for Service Doors	304
Spray Guns	372, 373, 589
Spray Gun Fittings	374
Strainer	266
Super Vac	295-300

Swivels	606, 631
Tire Shine Machine	293
Timers (for)	303, 361
Towels	66
Turbo Towel	451
Ultra Turbo-Nator®	292-294
Vac Islands	314
Vacuums	290-300, 306
Valve	627
Wands	387, 592
Jet Lube®	559
J-KO	488
Janitorial	

Brute®	740
Buckets	159
Can Liners	332, 740
Caution Signs	749, 750
Chemicals/Detergents	146, 742-744
Detergent Dispensers	741
Dolly	740
First Aid Kit	741
Gloves	167
Lids-Trash Containers	740
Trash Containers	740
Smoker's Waste Stations	333, 739
Trash Grabber	333, 739
Waste Receptacles	332, 333, 740
Jobe Float Valves™	630-631
John Guest® Fittings	646, 647
Johnson's®	414

K	
Karcher Fittings	597
Kip Solenoid Valves IMI	621, 622
Kleen & Green Hydraulic Fluid	269
Kleen-Rite	
Banners	431
Booms/Boom Parts	415
Boom Swivel	639
Brush Kit	370
Brush	401
Carpet Machine Shampoo	326
Check Valves	633, 634
Chemicals	

Anti-Freeze	688
Automatic/Touchless	678-682
Bug Master	682
Detail Chemicals	143-146
Dog/Pet Wash	453, 455, 456, 686
Kleen-Pak	676, 689
Kleen-Shine™	143-146
Kleen-Track	680, 681
Kleen-Tunnel	682
Self-Serve Ultra Concentrates	676, 677
Powders	679, 682
Triple Foam	687
Coin Boxes	410-412
Crimp Fittings	661
Detail Chemicals	143-146
Dog/Pet Wash	
Chemicals	453, 455, 456, 686
Parts & Supplies	454, 457
Pet Wash Setups	454
Signs/Banners/Decals	454-456
Vending	116, 458
Vending Decals	110, 116, 458
Easy-Kleen Station	689
Fragrances	326
Fittings	374, 654, 661

Guns	
Guns	371, 374, 588
Hook	392
Fittings	374
Kit	374
Hog Daddy	401
Hose	666, 673
Hose Assembly	666, 667, 670
Hose Kit	606
Hydraulic Fluid	269
Interior Vehicle Sani Kit	146, 741
Kleen & Green	269
Kleen-Pak	676, 689
Kleen-Pet™	454-456, 686
Kleen-Shine™	145, 146
Kleen-Track	680, 681
Kleen-Vend	51
Kleen-Vend Parts	51
Kleen-View	50
Kleen-View Parts	50
Lances/Wands	386, 593
Low Pressure Check Valve	634
Mat Clamp	393
Membranes	479
Menu Signs	440
Menu Strips	440

Nozzle Protector	385
Pump Kits	221
Price Decals	442
Regulators	252
Rotary Decals	441
Rotary Switches	409
Rotary Switch Parts	409
Signs	425-428, 432-439
Swivels	639
Swivel Kits	637
Timers	366
Towels	67-70, 169
Triple Foam	687
Unloaders	252, 612
Wands	386, 593
Windshield Wiper Bags	164
Windmaster Signs	425-428
Vacuum	
Hose	320
Motors	327-329
Motors for J.E. Adams	298, 299
Motor Gaskets For J.E. Adams	325
Vending Kits	44, 45
Kleen Rite® Extractors	204
Klopp®	
Accessories	285, 286
Coin Counters	285, 746
Scales	286
Sorters	285, 746
Token Cleaner	286
Kynar Tips	377
L	
Lake City Handwringer	369
Lamb	
Vacuum Motors	330, 331
Vacuum Motor Brush	330, 331
Lance Wands	386, 388
Laserwash™ Parts	546, 620
Last Alert Buzzer	363
Last Alert Timer	363
Latches	
For Super Vac	324
Vacuum	324
Laundry	
Bags	118, 736
Bulk Detergents	698, 742
Bulk Softeners	742
Cart Wheels	166, 735
Change Machines	747-748
Coin Counters	284, 746
CryptoPay	466-469, 745
Decals	118, 743
Detergent	117, 742-744
Detergent Decals/Overlays	118, 751
Detergent Dispensers	741
Fabric Softener	117, 742-744
Feather Flags	419-421, 750
Hangers	736
Laundry Carts/Trucks	166-168, 735-739
Liquid Bleach	698, 742-744
Out of Order Tag	118, 751
Signs	749-750
Simoniz®	698, 742
Stain Remover	117, 744
Vending/Vending Machines	118, 745
Laundramax Vender	118, 745
Laurel	
Venders	40-43, 116, 458
Vendor Parts	46-49
Leather Air Freshener	79, 81, 103
Leather Care	61, 64, 119, 121, 123, 125, 127, 128, 132, 133, 137, 145, 147-152, 155, 156
Leather Chamois	73, 175
Lexair Valve	253, 562
Lexol®	132, 156
Lights	
Ballasts & Accessories	51, 354
Banner LED Light Strips	352
Bulbs	
Fluorescent	353
LED	348-352
Probe Start	354
Pulse Start	354
Canopy/Ceiling Mount	338-339, 344
Coinbox Pilot Light	409
Cree	338, 340, 344
Fluorescent	353
G&G	345-349
Hubbell	342, 353-354
Jarvis	339, 353, 354
LED Light Strips	350-352
Lithonia Lighting	340
LSI	338, 339, 342-344, 354
Pole Mount	342-343

Replacement Lenses & Guards	353
Retrofit Kits	338
RGB Guide Lights	508
Ryko® Softgloss	511
TSS	429, 430
Light Strips	350, 352
Traffic Fixture	429, 430
Wall Mount	339, 340
Loctite	125, 414
Locks	
Abus	303, 405
American™	406
Chinrose®	406
Gem	404
Greenwald	404
Medeco	404
Meter Panel	404
Pinlock	406
Pick Proof	405
Vender	404
Lock Bars	304, 407, 412
Lock Guards	407
Loop Detector	563, 564
Low Pressure Chemical Injector	615, 734
Low Pressure Unit/Panel	
Generic Brand	461
Dosatron®	734
Lubricants	
Air Compressor	475
Anti-Seize	414, 559
Jet Lube®	559
Johnson's®	414
Loctite®	125, 414
Silicone	407
Spray	407, 414
Super Lube®	559
M	
Mac Solenoid Valve	626
Automatics Replacement	547
Magna Shine	
Decals	66, 113
Detailing Cloth	66
Detailing Clay	160
Paint Correction	165
Mat Clamps	393
Mat Cleaners	
Dralco	488
JKO	488
MatWacker	488
Rug Beater	488
Medeco Locks	404
For J.E. Adams	302
Mega-Vendor	
Machines	52-54
Parts & Accessories	53-56
Meguiar's®	
Applicator Pads	160
Detail	
Clay	160
Detail Chemicals	150-154
Retail	127-131
Polishers	195
Membrane Housings	480
Membranes (RO)	479, 480
Menu Signs	440, 445, 455
Mercury Relay	409
Metal Polish	125
Metering Tips	
Hydrominder	721
Dema Tip Kit (INDK100-15K)	728
For Motor City Wash Works®	533
Metering Valves	628
Micron Filters	480
MixRite	730
Mixing Tank	471
Monorail	
Door Catch	322
Door Gasket	322
Filter Bag	322
Timer	359
Lock	404
Mosmatic	
Air Boom	446
Booms	415-418
Boom Swivel	643-644
Comfort Hose Assembly	667
Drop Down Stem	418
Foamy Brushes	393
Gun Swivel	639
High Speed Swivel	644
Hose Assembly	667
Hurricane Pro	446
Lance	386, 592
LED Boom	417

Magnetic Position Device	418
Mat Holder	393
Mounting Bracket	418
Rotation System	565
Surface Cleaners	590
Swivels	639, 643, 644
Tire Cleaner	565
Undercarriage Cleaner	565
Wand Holder	391
Wands	386, 592
Wheelblaster Pro	565
Mothers®	
Back-To-Black®	136
California Gold®	134
CMX®	136
Detail Chemicals	149, 150
Retail	133-136
Speed™	135
Ultimate Hybrid™	136
Vending	62
Motors (Electric)	
Air Shamme	450
Baldor	268
For Belanger®	527
For Hanna™	543
For Motor City®	536
For Sonny's®	526
Marathon	268
Vacuum	298-300, 327-331
Motors (Hydraulic)	
Char-Lynn Motors	556-557
For Hanna™	537, 539, 540
For MacNeil®	543
For Ryko®	514
For Sonny's®	520
Parker	558
For Belanger®	527, 528
For Motor City®	532, 536
For Sonny's®	523-525
Sterling	558
For Ryko®	514
For MacNeil®	543
For Motor City®	536
For Sonny's®	520
Motors (Vacuum)	
Ametek®	
Carbon Brushes	327-331
For J.E. Adams Vacs	298, 300
Motors	327-331
Kleen-Rite	327-329
Lamb	330-331
Motor Contactors	
Allen Bradley	268
For Ryko®	512
Hartland Controls	268
MTM Hydro (Veloci Performance)	
Foamers/Foam Cannon	185
Guns	389
High Pressure Hose	604
Hose	604, 605
Hose Reels	603
Jetter Genie™	595
Kobrajet Hose	605
Sewer Jetter Conversion Kit	395
Mud Flaps	141
Mytee®	196-201
N	
National Automotive Chemical	
It Works!	714
Pit Deodorizer	486, 715
Plus Product Line	707
Premium Automatic/Self Serve	486, 715
Self Serve Ultras	708
Tire Shine	708
Triple Foam	708
Niftygrabber Trash	333, 739
Nitrile Gloves	161
Non-Working Swivels	655
Norgren	
Lubrication	262
Mini Filter/Regulator	260
Regulators	260
Solenoids	622, 623
Nozzles	
Aqua-Rocket™	383
AR North America	382
Automatic Nozzle Kit	375
Blast-Force™	383
Blast-Tec Pro™	383
Clip Eyelet	381
Drain Cleaning	375, 601
Floodjet®	378
Foamjet®	378
Foam Gun	374

General Pump®	375, 590
Giant	381, 382, 600
High Impact	382
Hydra-Flex	383
iMeg®	376, 596
Kynar	377
Quick Connects	597, 598
Quickjet®	378
Pressure Wash	596-601
Rotating	383, 599, 600
Spraying Systems Co®	376-382
Steam Nozzle	601
Suttner	382, 599, 600
Turbo	382, 383, 600
Turbo Laser	381, 600
TeeJet®	529
TriggerJet®	384
UniJet®	379, 529
Vacuum	316-318
Vector Wash Bundle	529
Washjet®	376, 382, 596
X-Jet	613
Nozzle Protectors	
Comet Pumps	385
Foam Gun	374, 681
GinSan®	385, 687
Kleen-Rite	385
Hamel Manufacturing Co.	385
J.E. Adams	385
Suttner®	385
MTM Hydro (Veloci)	385
Southern Pride	385
Spraying Systems Co.®	385
Nu Finish Sealant	142
Nu Towel/Nu Sham	71
Nylon Tap-It Anchors	434

O

Oil (Pump)	
Arimitsu	228, 542
CAT Pumps®	215, 530, 542
Champion Compressor	475
General Pump®	219
Giant	223
Hydra-Cell	226, 535
Hypro® (Pentair)	221
Orbital Polisher	
Cyclo®	194
Flex®	190-193
Meguiars®	195
Rupes® USA, Inc.	188, 189
Original Shammy	65, 116
O-Rings	186
Outdoor Banners	431
Ozium®	97
Ozonator	205
Ozone Generators	205

P

Padlocks	405-406
Pad Cleaner	159
Pad Perfect	562, 683, 684, 701
Pads (Orbital Polisher/Buffers)	
Buff & Shine	187
Cyclo®	194
Flex®	190, 191
Meguiars®	195
Rupes® USA, Inc.	190
Pails/Plastic Buckets	159, 716
Pail Openers	159, 718
Pail System	613
Pantron	
For Sonny's®	518
General	550
Parking Blocks	337
Para Plate® (US)	
Check Valves	635, 636
Guns	371
Regulators	258
Swivels	640
Timers	359
Parker®	
Air Regulator	262
Check Valves	635, 636
Composite Regulators	262
Crimpings	661
Crimp Fittings	661
Fast & Tite Fittings	659
Filter Regulator	262
Fittings	650, 661, 662
Hydraulic Hose & Fittings	652
Inline Swivel	638
Low Pressure Switch	519
Lubricator	262
Mini Regulator	262

Motors	
TB, TC & Torqmotor TE	558
For Belanger®	527, 528
For Motor City®	532, 536
For Sonny's®	523-525
Triple-Lok	662
True Seal Fittings	650
Tube & Hose Fittings	662
Regulators	262
Reusable Fittings	661
Solenoid Valves	623
Swivels	638
Valve Diaphragm Kit	512
Parker Engineering	
Coin Acceptors	357
Grace Timer	361
Slugbuster®	357
Parker Ross Motors	
TB, TC & Torqmotor TE	538
For Belanger®	527, 528
For Motor City®	532, 536
For Sonny's®	523, 524, 525
Parker Skinner Valve	623
Peco®	
Cloth/Foam Replacement	577
Mitter Cloth Replacement	579
Pennant Strings	
421	
Pet Wash	
Chemicals	453-455, 686
Complete Setups	453, 454
Decals	110, 116, 454-456
Flags	419, 455
Parts	457
Signs	426, 455, 456
Vending	453, 458
pH Test Kit	717
Pictorial Signs	438
Pilot Light	409
Pin Locks	406
Pipe Heat	459
Plastic Bags-Wind Shield Wiper	164
Plasticade®	424
Pit Cleaner	485, 715
Pit Deodorizer	486, 715
Plumbing Fittings	446, 647
Pole Covers	335, 336
Polishers	
Cyclo®	194
Flex®	190-193
Meguiar's®	195
Rupes	188-189
Polyflex Foamy Hose	370, 390, 667
Poly Tube Fittings	
Alpha Technologies	652
John Guest®	646-647
Kleen-Rite Brass	654
Parker® Fast & Tite	659
Parker® True Seal	650
Poly Tube Cutters	647
Poly Tubing	514, 518, 543, 666
Pop Off Valves	627
Post Guard®	336
Portable Heaters	483, 484
Plant Master Hose	672
Plastic Tube Snip	647
Plasticolor	78, 141
Powdered Chemicals	
Kleen-Rite	679, 682
Laundry	698
Simoniz®	698-700
Pressure Washers	583-587
Pressure Washing Supplies	
Brushes & Brooms	591, 595
Check Valves	598
Chemicals	614, 615
Chemical Injectors	613, 615
Filters	601
Foot Valves/Strainers	598
Garden Hose Fittings	606
Gas Cans	587
Guns	
CAT Pumps®	589
General Pump®	589
Giant	589
J.E. Adams	589
Kleen-Rite	588
MTM Hydro (Veloci)	589
Mecline	589
Suttner	588
Veloci (MTM Hydro)	589
Gutter & Sewer Assemblies	595
Hose	604-606
Hose Guards	606
Hose Reels	602, 603
Hose Reel Swivel	606

Karcher Fittings	597
Lances/Wands	592-594
Nozzles	
Adjustable	599
Drain Cleaning	601
Holder	596, 598
Quick Connect	597-598
Rotating	599, 600
Turbo	600
Washjet®	596
Pumps	607-610
Quick Connect Spray Tips	597, 598
Steam Nozzle	601
Superball	606
Surface Cleaners	590, 591
Telescoping Wands	591, 592
Turbo Nozzle	600
Wands	592-594
Water Brooms	591
Unloaders/Regulators	611, 612
Prep Unit	
Pre Soak	
JBS®	709-710
Kleen-Rite	677-682
Kleen-Pak	689
Kleen-Track	680, 681
Kleen Tunnel	682
National Automotive Chemical	707
Shore Corporation	713
Simoniz®	689-692, 699, 703
Trans-Mate	706-708
Pressure Cleaner	583-587
Pressure Gauges	
267	
For Hanna™	542
For Ryko®	513
For Sonny's®	522
Pressure Regulators	
For Automatics	547
For Pressure Washing	611, 612
Pump Accessories	232, 234, 258, 263
Zero Pressure	261
Pressure/Safety Relief Valves	252, 254, 258
Pressure Switch	
Furnas	264
Square D	264
Pressure Washing Chemical Kits	615
Price Decals	442, 443, 446
Price Signs	434, 446
Procon® Pumps	233
Propane Tanks	484
Proportioners	
Aqua Master	723
Kleen-Rite Aqua Master	723
Dema	723, 730
Dosatron	733, 734
For Detail	206
For Hanna™	541
For Motor City Wash Works®	533, 535
For Sonny's®	522
Hydro Systems	206, 719, 720, 731, 732
MixRite	730
Proportioner Tip Kit	533, 721, 728, 730
ProPower	477-478
ProPulse	
Cleanstream™	604, 670
Hot Clean	605
Pressure Wash Hose	604-606
Tough Cover	666
Uberflex™	604, 670
Proto-Vest Dryers	566
Proximity Switch	
Carlo Gavazzi	553
Banner	
Cord Sets	551
For Hydro-Spray	503
For Ryko®	511
Sensors	551
IFM Effector	553
Pantron	550
For Sonny's®	518
Turck	549
For Hydro-Spray	503
Telemecanique	549
Telco Sensors®	552
Prospector, The	321
Proximity Switch Cable	
Murr	549
Pantron	550
Telco Sensors®	552
Pulleys	
269	
For Automatics	
D&S®	548
Hydro-Spray	504, 505
For Booms	446
For General Pump®	219

Pulley Bushings.....	269
Pulley Driven Pumps	
Arimitsu.....	227, 522
Cat Pumps®.....	207-210
General Pump®.....	216, 608
Pulsation Dampeners	
(for) CAT Pumps®.....	215
Kleen-Rite.....	221
Pulse Hose.....	221
Pumps & Parts	
Aquatec.....	251
AR North America.....	243, 608, 609
Arimitsu.....	227, 228
ARO.....	242
Blue/White®.....	230
Berkeley.....	242
CAT Pumps®.....	207-215, 610
Comet.....	229, 601
Dayton.....	240
Etatron (Dilution Solutions).....	231
Flint & Walling.....	240
Flojet®.....	235-238
For Hanna™.....	541
For Motor City®.....	535
For Sonny's®.....	525
Fluid-O-Tech.....	234
General Pump®.....	216-221, 607, 608
Giant.....	222, 223, 607
Goulds.....	241
Graco Husky.....	250
Hydra-Cell.....	225-226
IR Aro.....	242
Pentair Sta-Rite.....	239-240
Procon®.....	233
Pulsafeeder.....	229
Sandpiper®.....	244
Shur-Flo®(Pentair).....	246-247
Sta-Rite.....	239-240
Stenner®.....	249
Versamatic®.....	245
Yamada®.....	248-249
Pump Stands	
Dual Pump Stand.....	462
Variable Frequency Drive.....	462
One Pump Units.....	462
Pusher And Die.....	661
Crimp.....	655
PVC	
Bulkhead Fittings.....	471
Check Valves.....	598, 634, 635
Fittings.....	646-650
Foamy Brush Handles.....	389
Hose.....	669
Hose Barb.....	628, 629
Hose Guard.....	663
Nozzle.....	377, 378
Pulsatron Check Valve.....	229
Signs.....	748-750
Spray Tips.....	377, 378

Q

Quick Connect	
Cable (For Quick Connect Sensor).....	550
Fittings.....	597
Gutter Cleaner Attachment.....	595
Injector.....	724, 725, 729
Nozzle Holder.....	596
Spray Tips.....	375, 597, 598
Rotary Switch.....	408-409
Socket.....	522
Wand with.....	593-594
Quick-Dry®	
Decals.....	76, 77, 110, 111
Detail Supplies.....	175
Sprays (Vending).....	76, 77
Spritz It!.....	76
Towels.....	75, 76, 116
Vending.....	75, 76

R

Reclaim	
Chemicals.....	486, 702, 709, 715
Pumps.....	253
Ryko® Parts.....	512
Recora®.....	554
Regulators & Regulating Valves	
ARO.....	261
CAT Pumps®.....	252, 610
Composite.....	262
For Hanna™.....	543
For Ryko®.....	513, 516
For Sonny's®.....	521, 525
General Pump®.....	253
Generant.....	258
Giant.....	259

Hydra-Cell.....	260
IMI Norgren®.....	260
Hypro®(Pentair).....	255
IR Aro.....	261
J.E. Adams.....	252
Kleen-Rite.....	252
Mac.....	516
Mini.....	261, 263
Norgren (IMI).....	260
Parker.....	262, 547
Pentair.....	255
Pressure Wash.....	610
SMC®.....	263
Specialty Mfg. Co.....	253
Suttner.....	255
U.S. Para Plate®.....	258
Wanner.....	260
Watts.....	258
Zero Pressure.....	261
Relay-Mercury.....	409
Relief Valves	
AR North America.....	255
Cat Pumps®.....	627
For PDS Sprayer.....	186
Fluid Controls.....	627
General Pump®.....	608, 612
Giant.....	223, 259, 627
J.E. Adams.....	627
Kleen-Rite.....	252
Spraying Systems®.....	258
Suttner.....	255
Thermal Protector.....	608
Thermo.....	627
Replacement Roller	
Belanger®.....	495, 527, 530
Econocraft®.....	492, 496
Hanna™.....	492, 493, 538
MacNeil®.....	492
Motor City Wash Works®.....	532
Parts.....	492, 495, 497, 514, 526, 530, 538
RCV.....	492, 538
Ryko®.....	497, 514, 517
Sonny's®.....	497, 526
Restorzit.....	715
Retrofit Kits	
Changers.....	277
CryptoPay.....	469
Float Switch.....	201
Laurel Venders.....	41
LED9.....	367
Lights.....	338
Mat Holder for Trash Can.....	332
Mytee® Float Switch.....	201
Nozzle.....	383
Scottsdale.....	338
Reverse Osmosis System	
Diamond H2O/ProPower.....	478
GinSan.....	476
Ring-O-Matic.....	485
Roberts Float Valves.....	629
Rollers	
Belanger®.....	497, 527, 530
Econocraft®.....	492, 496
Hanna™.....	492, 496, 538
MacNeil®.....	495
Motor City Wash Works®.....	532
Parts.....	492, 495, 514, 526, 530, 538
RCV.....	492, 538
Ryko®.....	497, 514, 517
Sonny's®.....	497, 526
Roller & Chain Chart.....	491
RO Accessories.....	477-478
RO Membranes.....	479, 480
RO Filters.....	480
RO Housings.....	480
Rotary Decals.....	441
Rotary Extractor.....	199
Rotary Knobs.....	409
Rotary Polisher	
Polishers.....	188-195
Pads.....	187, 190, 191, 194, 195
Rotary Switches	
8 Position.....	408
10 Position.....	408, 409
12 Position.....	408
Electronic.....	408, 409
ElectroSwitch.....	408
Kleen-Rite Q-C.....	409
Parts.....	409
Shallco.....	408
Rotary Vane Pump.....	233-234
Rowe	
Changers.....	282, 747
Kits.....	282-283
Rubbermaid®	

Brute®.....	740
Caddy.....	158
Caddy Bag.....	740
Cart.....	167, 739
Collapsible Cart.....	167, 739
Drum Dolly.....	740
Smoker's Station.....	333, 739
Steel Street Basket.....	332
Waste Containers.....	332, 740
Rug Beaters	
Dralco.....	488
J-Ko.....	488
Ryko Replacement Parts.....	497, 509-517

S

Safes.....	407
Safe Cash System.....	465
Safety Glasses.....	163
Safety Goggles.....	163
Sandpiper® Pumps.....	244
Sanitizer.....	146, 742
Sanitizer (Air).....	97, 205
Sanitizer Kit.....	146, 741
Scale, Coin.....	286
Scan Coin Counter.....	284, 286
Screw Locks.....	302, 404
Sealants	
Ceramic.....	694
Jet Lube®.....	559
Kleen-Rite.....	677, 678
Kleen-Seal.....	678, 681
Kleen-Shine™.....	145
Kleen-Track.....	678, 681
Loctite®.....	414
National Automotive Chemical.....	707, 708
Sonimoz®.....	147, 690, 694, 697, 701
Thread.....	414, 663
Seat Covers.....	164
Sensors	
Carlo Gavazzi.....	553
Banner	
Cord Sets.....	551
For Hydro-Spray.....	503
Sensors.....	551
IFM Effector.....	553
Murr Elektronik.....	549
Pantron.....	550
For Sonny's®.....	518
Sensor Dynamix.....	489, 490
Turck.....	549
For Hydro-Spray.....	503
Telemecanique.....	549
Telco Sensors®.....	552
Secure Coin.....	360
Security	
Cameras.....	463-465
Locks.....	404-406
Lock Bars.....	304, 407
Safes.....	407
Systems.....	463-465
Sensortron.....	51, 312, 357
Shampoo	
Fragmatics®.....	328
Kleen-Pak.....	689
Kleen-Rite.....	326
Meguiar's®.....	151
Pet Wash.....	453, 455, 456, 686
Machines.....	294, 297, 310, 313
Machine Parts.....	323-325
Decals.....	302
Shur-Flo®(Pentair).....	246-247
Shut Off Valves.....	253, 633, 646, 650
Signs	
Bay Signs.....	432-440
Bilingual	
Bay Signs.....	437
Deluxe Signs.....	437
Instruction Signs.....	437
Laundry Signs.....	750
Menu Signs & Strips.....	440
Windmaster Signs.....	425-428
Vacuum Signs.....	313, 427, 444
Caution.....	304, 313, 432-436, 439, 444
Changer.....	432, 433
CryptoPay.....	437
DeSalt.....	425, 685
Deluxe.....	432
Dog/Pet Wash.....	426, 445, 455, 456
Electric/Lighted.....	429-430
Exit.....	434
Instructional.....	429-430, 432-440
Laundry.....	749-750
Menu Sign/Strips.....	440
Message Boards & Signs.....	438
Pictorial.....	438

Price.....	434
Red & White.....	434-436
TSS.....	429-430
Vacuum.....	313, 444
Windmaster.....	425-428
Sign Holder.....	424
Simoniz®	
Ceramic Coatings.....	142
Ceramic Sealant Arch.....	694
Chemicals	
Additives.....	690
Bug Remover.....	685
Ceramic Sealant.....	694
Desalt.....	685
Don't Bug Me.....	685
Eliminator.....	156, 742
Green Scene.....	703
High Performance Profit Center.....	701
Hot Wax & Shine.....	452, 474, 693
Hyper Pak.....	692
Kleer Kote.....	693
Laundry.....	698, 742
Liquid/Self Serve.....	691
Maintenance.....	715
Pad Perfect.....	562, 683, 684, 701
Powders.....	698, 742
Pressure Wash.....	614-615
Prime Pak.....	690
Rx for Reclaim.....	702
Specialty Products.....	615, 700
Spray Shine/Polishes.....	697
Tire Shine.....	684
Titraion Kit (for Simoniz®).....	717
Touchless/Cloth Automatic.....	696
Triple Foam.....	687, 697
Tri Foam Spray Shine.....	687, 697
Tropical Bay Hyper Pak.....	692
Vision Clear.....	685, 701
Wheel & Tire.....	698
Winter Anti-Freeze.....	688
Decals	
Menu Strips.....	440, 452
Vending.....	59, 109-110
Detail	
Blend Center.....	148
Can Paste.....	142
Chemicals.....	143, 148
Diamond Plate.....	142
Odor Eliminator.....	156
Sanitizer/Disinfectants.....	146, 742
Ultra Concentrates.....	148
Diamond Plate.....	142
Laundry.....	698, 742
Hot Wax System.....	452, 474, 693
Maintenance Chemicals.....	715
Odor Eliminator.....	156, 742
Pad Perfect.....	562, 683, 684, 701
Pressure Wash Chemicals.....	614-615
Retail	
Aerosols/Sprays.....	139
Sanitizer/Disinfectants.....	146, 742
Signs/Banners.....	428
Tire Shine.....	59, 684
Vending	
Auto Glass Cleaner.....	59
Deals.....	114, 115
Decals.....	109, 110
Flat Vending Bottles.....	59
Sprays.....	59
Wheel Cleaner.....	59
Wipe Packs.....	59
Wax Pad Applicator.....	59
Wax Applicator.....	59
Signicade Signs & Holders.....	423
Silicone	
Compound.....	559
Gasket Maker.....	414
Grease.....	559
Lubricant.....	407, 414
Tire Shine Sponge.....	63
Slugbuster.....	280, 357
SMC®	
Connectors & Elbows.....	648, 649
For Ryko®.....	513
For Sonny's®.....	520
Regulators/Filters.....	263
Water Separator.....	263
Specialty Manufacturing Co.	
Basket Strainer.....	266
Ball Valve.....	628
Check Valves	
Brass.....	633
Brass Ball.....	635
High Pressure.....	635-636
Inline.....	636

Polypropylene.....	634
PVC.....	634-635
Clear Bowl Strainers.....	266
Hose Barbs.....	634
Metering Valve.....	628
Regulators/Unloaders.....	253
Strainers.....	266
Swivels	
Ball Bearing.....	639
Boom.....	644
Smoker's Station.....	333, 739
Soap	
Amazing Glow Foam®.....	687, 711
Bug Remover.....	682, 685, 713
Dog Wash.....	453, 455, 456, 686
Glow Foam.....	687, 711
Green.....	703
JBS Industries®	
Amazing Glow Foam®.....	687, 711
Automatic.....	717
Self-Serve Concentrate.....	709
Triple Foam.....	687
Winter Anti-Freeze.....	688
Kleen-Pak.....	689
Kleen-Rite	
All-Systems.....	678
Automatic Detergents.....	679-682
Bug Master.....	682
Bug Remover.....	682
Dog Wash.....	453, 455, 456, 686
In-Bay Presoak.....	679
Kleen-Pak.....	689
Kleen-Track.....	680-681
Kleen Tunnel.....	682
Powders.....	682
Self-Serve Ultra Concentrate.....	677
Triple Foam.....	687
Wheel & Tire.....	698
Winter Anti-Freeze.....	688
Laundry.....	698, 742
National Automotive Chemical.....	707-708
Plus Product Line.....	707
Powders.....	708
Premium Automatic/Self Serve.....	708
Self Serve Ultras.....	708
Tire Shine.....	708
Triple Foam.....	708
Pet Wash.....	453, 455, 456, 686
Pressure Wash.....	614-615
Shore Corp.....	712-714
Simoniz®	
Bug Remover.....	685
Ceramic Sealant.....	694
Desalt.....	685
Don't Bug Me.....	685
Eliminator.....	156, 742
Green Scene.....	703
Hot Wax & Shine.....	452, 474, 693
Hyper Pak.....	692
Kleer Kote.....	693
Laundry.....	698, 742
Liquid/Self Serve.....	691
Maintenance.....	715
Pad Perfect.....	562, 683, 684, 701
Powders.....	698, 742
Pressure Wash.....	614-615
Prime Pak.....	690
Specialty Products.....	615, 700
Spray Shine/Polishes.....	697
Tire Shine.....	684
Touchless/Cloth Automatic.....	696
Triple Foam.....	687, 697
Tri Foam Spray Shine.....	687, 697
Tropical Bay Hyper Pak.....	692
Vision Clear.....	685, 701
Wheel & Tire.....	698
Winter Anti-Freeze.....	688
TransMate™	
Drying Agents.....	704
In-Bay.....	704
Sealers/Polishes.....	704
Tire Dressing.....	705
Tunnel.....	704
Vivid Self-Serve.....	706
Wheel Cleaners.....	705
Triple Foam.....	679, 687, 708, 704
Triple Foam (low pH).....	687
Whitewall, Wheel & Tire Cleaners	
Kleen-Pak.....	689
Kleen-Rite.....	698
Kleen-Shine™.....	144
Meguiar's®.....	127, 129
Mothers®.....	133, 135
National.....	708
Shore Corporation.....	713

Simoniz®.....	698
Winter Anti-Freeze.....	688
Winter Triple Foam.....	688
Soap Control Unit & Probe.....	716
Solenoids	
ASCO®.....	624
Danfoss.....	547, 562, 625
Dema.....	616-619
Dole.....	625
Erie.....	625
For Belanger®.....	528
For Hanna™.....	540
For Hydro-Spray.....	541
For Motor City Wash Works®.....	532, 534
For Ryko®.....	513, 516
For Sonny's®.....	525
G.C. Valves.....	620, 621
IMI Norgren®.....	622
Kip.....	623
Lexair, Inc.....	253, 562
Mac®.....	626
Parker/Skinner.....	623
SMC.....	626
Sonic Swivels.....	639
Sonic Wash.....	677
Sonny's®	
Cloth & Foam.....	575-577
Mitters.....	580
Nozzle Retrofit Kit.....	383
Replacement Parts.....	518-526
Rollers.....	496, 497
Sorter (Coin/Currency).....	284-286
Sorter Cleaners.....	288
Southern Pride	
Nozzle Protector.....	385
Replacement Parts.....	545
Speed Bumps.....	337
Spill Kit.....	715
Spiral Hose Guard.....	663
Split Eyelet.....	380
Split Loom.....	409
Sponges	
Armor All®.....	55, 60
Blue Magic®.....	63
Ceramic Applicator.....	173
Dual Surface Microfiber.....	73, 175
Leather Chamois.....	73, 175
Paint Correction.....	165
Scrub.....	176
Spot Remover	
Chemicals	
Fragramatics®.....	326
Kleen-Rite.....	326
Simoniz®.....	139
Machines/Parts	
Fragramatics®.....	323-325
IVS.....	311-313
J.E. Adams.....	310, 314, 322
Spot Free System	
Diamond H2O/Pro Power.....	477-478
GinSan®.....	476
Spray Arch Assemblies.....	380-381
Sprayway® Glass Cleaner.....	55, 62, 132
Spray Bottles.....	158
Spray Bottle Labels.....	144
Spray Nozzles and Accessories	
Automatic Nozzle Kit.....	375
Blast-Force™.....	383
Blast-Tec Pro™.....	383
Clip Eyelet.....	381
Drain Cleaning.....	375, 601
Floodjet®.....	378
Foamjet®.....	378
General Pump®.....	375
Giant.....	381
High Impact.....	382
Hydra-Flex.....	383
iMeg®.....	376
Kynar.....	377
Quick Connects.....	375, 597
Quickjet®.....	380
Pressure Wash.....	599
Rotating.....	383, 599
Spraying Systems Co®.....	376
Steam Nozzle.....	601
Suttner.....	382
Turbo.....	382
Turbo Laser.....	382
TeeJet®.....	379, 529
TriggerJet®.....	384
UniJet®.....	529
Vector Wash Bundle.....	529
Washjet®.....	376, 382, 534, 596
X-Jet.....	613
Spray Tip Twister.....	375

Spray Guns	
Cat Pumps®	371, 374, 589
For Fragrance Machines	323
Dump	374
Giant	371, 589
General Pump®	589
J.E. Adams	372-373, 589
Kits	370, 588
Kleen-Rite	370-371, 374
Mecline	372, 522, 589
Pressure Wash	588-589
Spraying Systems	373
Suttner	372-373
Triple Foam	374, 687
U.S. Paraplate	371
Veloci (Formerly MTM Hydro)	372, 589
Speakers	508
Spraying Systems®	
Adjustable Siphon Injector	726
Diaphragm Check Valve	380
Foam Gun Nozzle	374, 681
For Motor City Wash Works®	534
Metering Plate	379
Nozzle Body	379
Nozzle Caps	379
Nozzle Protectors	385
Nozzles/Spray Tips	
Floodjet®	378
Foamjet®	378
Stainless & Kynar	377
Teejet®	379
Triggerjet®	384
Turbo	382
Unijet®	379
Washjet®	382
Quickjet®	380
Regulating Valves	258
Relief Valves	258
Split Eyelet	380
Spray Assemblies	380
Strainers	379
Swivels	638
Trigger Guns	384
Spring Flex Wand	388
Sprockets	499
For Hanna™	537
For Hydro-Spray	502, 505
For Ryko®	515
For Sonny's®	519, 520
Square D	264
Square Safe	407
Steering Wheel Covers	164
Stop and Go Light/TSS	429
Strainers	
Basket	266
Clear Bowl	265, 266
Dog/Pet Wash	457
Foot	598
For Belanger®	529
High Pressure	265
Inlet	721
Pressure Wash	598
Spray Tip/Nozzle	379
With Check Valve	379
Y-Type	266
Standard Changers	277, 748
Sta-Rite Pumps	239-240
Steamers	202
Steel Eagle	603
Stenner Pumps	249
Sterling Motors	558
For MacNeil®	543
For Motor City Wash Works®	536
For Ryko®	514
For Sonny's®	520, 524
Storage Tanks	471
Stoner® Car Care	137-138
STP®	126
SubZero	459
Super Lube®	559
Super Swivels®	641-642
Popular Automatics Replacement	547
Suttner	
Adjustable Nozzle	599
Chemical Injector	726
Ceiling Boom	416
Fittings	597
Float Valve	633
Foam Injector	615
Guns	373
Karcher Type Fittings	597
Nozzle	382
Nozzle Protectors	385
Quick Connect	

Chemical Tip	597
Spray Tip Kit	597
Regulator/Unloader	255
Rollover Nozzle	599
Rotating Brush Assembly	595
Sewer Hose	606
Swivels	638
Superball	606
Turbo Nozzles	382
For Motor City®	534
Wands/Lances	386
Swivels	
Ball Bearing	637, 639
Big Boy	638
Boom	638, 635, 644
Break Away	638
Deublin®	640
Double Bearing	641
Economy	637
Fluid Controls	637, 640
Gun	590, 639
High Pressure	606, 638
Inline	638, 640, 642
J.E. Adams	637
Kit	637
Kleen-Rite	637
Low Pressure	637
Mosmatic	638-639
Non-Working	655
Parker	638
Specialty Mfg. Co.®	639, 640
Sonic	639
Spraying Systems Co.®	638
Straight	637, 638, 640, 662
Super Swivels®	641-642
Suttner	638
U.S. Para Plate	640
Value Line	640
Zierden	418
Switches	
Empty	46
Float	201
Floor	
For Hydro-Spray	507
For Motor City®	532
For Sonny's®	518
Recora®	554
Tapeswitch®	555
Flow	267
Pressure	264
For Flojet®	238
For Sonny's®	519
Proximity	
Banner®	551
For Hydro-Spray	503
For Ryko®	511, 513, 514
Telemecanique	549
Turck	549
Rotary	408-409
Treadle	554-555
Superball	606
Surface Cleaners	590-591
T	
Taco Cartridge Circulator	482
Tanks	
Expansion	264
For Sonny's®	471, 522
Mixing Tank	471
Open Top	471
Polyethylene	471
Propane	484
Round	471
Sprayers	186
Square	471
Storage	471
Wall	560
Tank Heater (Watlow)	471
For Hanna™	542
Tankless Water Heaters	481
Tank Sprayers	186
Tapeswitch®	555
Tapit Anchors	434
Telemecanique	549
Telco	
Multiplexers	552
Receivers	552
Set	552
Transmitters	552
Terminal Kit	414
Terminal Strips	409
For Vacs	301
Test Kits	717
Thread Locker	414
Ties, Cable	413

Timers	
Dixmor	367-368
GenSan®	362-364
J.E. Adams	361
IDX	361, 364, 365
Infitec	366
Kleen-Rite	366
Magikist	361
Monorail	359
U.S. Para Plate	359
Parker	361
SSAC	361
TimeMaster	360
Tip Twister®	375
Tip Kits	
Dema	728, 730
General Pump®	597
For Motor City Wash Works®	533
Hydrominder	721
Suttner	597
X-Jet	613
Tip Protectors	385
Tire Brushes	
Automatic	567
Detail	179-180
Erie Brush	567
For Belanger®	567
For Hanna™	539
For Sonny's®	567
Poodle	523, 539, 567
Round	179
Tampico	179-180
Universal Brush	567
Weiler®	180
Wheel Wonder®	567
Tire Foam	
Armor All®	60, 122
Meguiar's®	129
Vender	42
Tire Inflators	309
Tire Rim	547
Tire Shine/Cleaners	
Applicator Pad (dressing)	160
Chemicals	
Kleen-Rite	145-146
Meguiar's®	151-152
Mothers®	149
National	708
Shore	712-713
Simoniz®	684
Decals	107-112
Armor All®	122
Meguiar's®	127, 129
Mothers®	133, 135-136
Stoner	137
Vending	
Armor All®	60-61
Blue Magic®	63
QuickDry®	77
Simoniz®	59
Titration Kits	717
Tokens	287-288
Tools	
Buffing Pad Cleaning Tool	159
Drum Wrench	718
Pail Opener	718
Razor Blades & Scrapers	177
Tornador	183
Touchless Chemicals	
Kleen-Rite	680, 681
Kleen-Track	680, 681
Simoniz®	701
Trans-Mate™	704
Towels	
Armor All®	124
Atlas	72
Blue Sham®	71
Bulk	26, 69, 70, 74
Champ	72
Cleaner Towelette	77
Detail	36-39
Dr. Joe	22-39, 170-174
Giant	74
Glass Cleaning	33-35
J.E. Adams	66
Kleen-Rite	
Big Boss	68
Big Blue	69
Big White	69
Blue Bulk	70
Blue Cloth	69
Detail Towels	169, 175
Flat Packed Terry	68
Kleen Shams	70
Terry	69

Microfiber	68
Nylon Scrim	70
White Bulk	70
MagnaShine™	165, 176
Microfiber	33, 34, 37, 39, 44, 75
Nu-Sham	71
Original Shammy	67, 121
Quick Dry®	
All American	75
Cloth Towel	75-76
Detail	175
Detailing Diaper	76
Microfiber	75, 76
Pad with Pocket	76, 175
Triple Wash	
Vending	75
Rainwipes®	73
Think Thick	35, 173
Waffle-Weave	33, 34, 78
Wet Towel	72
Towels by Doctor Joe®	22-39, 170-174
Ambassador	32, 35
Body Drying	28, 30-32, 173
Ceramic Coating	173
Courtesy	31, 36
Detail Towels	36-39, 170-174
Glass	34-35
Plush	37, 172
Surgical	35
Towel Emulsifier	29, 741
Traffic Cone	162
Transformers	
Coinbox	413
Coin Mech	281
Vacuum	298, 312
Vender	49
Trash Containers	332-333
Trash Grabber	333, 739
Trans-Mate Chemicals	704-706
Trash/Mat Holder	332
Trash Enclosures	332
Triad Changers	275, 747
Triple Foam Units and Accessories	
Decals/Signs	440, 701
Gun	374, 687
Hose	390, 666
Triple Foam Unit	560, 461
Truck Brushes	
Erie	400
Universal	396
Value Line	402
Weiler®	402
TSS	
Foamers	561
Lights	352
Signs	429-430
Traffic Signals	429-430
Tubing	
Coiled	666
Excelon	666
Non-Reinforced	669
Nylon	666
PVC/ Polybraid	669
Radiant Heat	484
Reinforced	669
Size Chart	660
Triple Foam	390, 666
Turbo-Nator®	293-294
Turbo-Rotor Arm	645
Turbo Towel	451
TurboWash Tower	504
TurboWash Security System	463-465
Turck Sensors	549
For Hydro-Spray	503

U

Udor Pumps	226
Ultra Concentrates	
Hyper Pak	692
JBS®	709-711
Kleen-Pak	689
Kleen-Rite	677-682
National Automotive Chemical	708
Prime Pak	690
Simoniz®	148, 690, 692, 693, 696-703
Trans-Mate®	704-706
Ultra-Concentrate Hydrominder	719
Underbody Cleaner	
Hydro-Spray	447
Mosmatic	446
Suttner	386
Undercarriage Cleaner	
Chemicals	

Kleen-Shine™	143-146
Meguiar's®	151-152
Simoniz®	696
Menu Strips	440
Mosmatic	446, 565
Nozzles	383
Unloaders	
AR North America	255, 610
For Hanna™	542
For Sonny's®	522
General Pump®	254, 256, 257, 611
Giant	259, 612
Kleen-Rite	252, 612
Suttner	255, 610
UniJet®	
Adapter	380
Assembly	379
For Belanger®	529
Nozzle	379
Universal	
Bi-Level	396
Detail	178, 179
Hogs Hair	394, 395, 396
Monster & Monster XL	394
Parts	397
Poodle	567
Prep	396
Round	178, 395, 396, 397
Spare Parts	397
Stack	397
Standard Tire	567
Synthetic	394, 395, 396, 397
Tire, Cloth	567
Tire Dressing	567
Toothbrush Style	178, 397
Triple Surface	395
Truck	396
Upholstery	178, 397
Wheel	396, 397
Universal Pad Washer	157
U.S. Para Plate®	
Guns	371
Regulators	258
Swivels	640
Timers	359
V	
V-Belts	269
For Sonny's®	522
Vac It Up	465
Vacuums	
Check	329
Clean Out Bags	298, 302, 312
Clean Out Canisters	321
Cuffs	317
Crevice Tool	318
Decals	
Caution/Instruction	313, 444
Tank/Dome	301, 313
Price	313, 442-444
Domes	298, 299, 304
Door Gaskets	298, 299, 301, 302, 322
Dualer	319
Filter Bags	322
Fuses	322
Hanger	318
Hose	319-320
Hose Adapter	317
Islands	314
IVS	311-313
J.E. Adams	289-300
Decals	302, 305
Parts	301-304
Latches	322
Lock Bars	304
Motors	
Ametek	330-331
Brushes	329
Check	329
Gaskets	298, 299, 301, 302, 322
Kleen-Rite	327-329
Lamb	330, 331
Nozzles	318
Nozzle Hangers	318
Pedestals	303
Prospector	321
Signs	
"DO NOT" Signs	313, 444
Free Vacs Banner	431
Free Vacs Windmaster	427
Test Gauge	329
Timers	303, 307, 360-368
Tool Kit	318
Upholstery Cuff	317
Validators	

CoinCo.	56, 273, 355, 356
Cover	53
CPI/Talos	51, 56, 274, 356
Pyramid	273, 355
Value Line	
Bollard Covers	335
Boom Swivels	640
Brushes	401, 402
Brush Handles	389
Check Valves	634
Mat Clamps	393
Swivels	640
Wand Holders	391
Valley Products	628
Valves	
Ball	628, 635
Brass Check	633-636
Check	
Barbed	598, 634
Blue/White Pumps	230
Brass	634, 635, 636
Brass Ball	635
Chemical	636
CVT	635
Dema	629
Diaphragm	380
Drip Free	380
Fluid Controls	636
Foot	598, 635
For Belanger®	529
For MacNeil®	544
For Motor City®	532, 534
For Ryko®	513
For Sonny's®	520, 521, 523
High Pressure	520, 636
Inline	598, 636
Inline Chemical	636
John Guest®	646
Kit for Flojet G57	234, 235
Kits for other Flojet	236, 237
Kleen-Rite	633, 634
Low Pressure	633
Maxi Flow	633
Parker	635, 636
Polypropylene	634
Poly Tube	646
Pressure Wash	598
Pulsatron Injection	229
PVC	598, 634
Regular	380
Specialty Mfg. Co.	634, 635, 636
Spraying Systems Co.®	380
Stainless Steel	547, 634, 635
Strainer (with)	379, 635
U.S. Para Plate	635, 636
Value Line	634
With Check Strainer	635
Check, Strainer With	379, 634
Chemical Filter With	601
Diaphragm Check	380
For Belanger®	529
For Motor City®	532, 534
For Sonny's®	523
Float	629-633
Foot	230, 598, 635, 720, 722
For Pressure Wash	598
For Motor City®	533
For Ryko®	512, 513
Foot Check	598, 635
Foot Strainer	598, 635
High Pressure	633
Industrial	519
Inline Check	598, 635
Low Pressure Check	633
Polypropylene Check	634
Metering	628
Safety Relief	186, 627
Safety & Pop Off	627
Shut-Off	253, 562, 628, 633, 646, 650
Solenoid	
3-Way	625
Asco®	624
For Automatics (Popular)	547
For Belanger®	528
For Hanna™	541, 542
For Motor City®	532, 534
For Ryko®	513
For Sonny's®	525
Danfoss	562, 625
Dema	616-619
Dole	625
Erie	625
G.C. Valves	620-621
IMI Norgren	622-623
MAC	626

Parker.....	623
Stainless Steel Check	547, 634, 635
Tankless Water Heater.....	481
Three Way Valves.....	625
Vapamore.....	202
Variable Frequency Drive Pump Stand.....	462
Variable Speed Polisher	188
Variable Speed Pump.....	251
Venders & Vender Deals	
Deals	
Five Column.....	115
Single Column.....	114
Three Column.....	115
Dog Wash	116, 458
Laurel	
Bottle	43
Electronic.....	41, 42
Little Trees®.....	41-43
Mechanical.....	42, 43
Parts	46-49
Retrofit Kits.....	41
Tire Foam	42
Kleen-Vend & Parts.....	51
Kleen-View & Parts.....	50
Mega-Vendor.....	52-54
Mega-Vendor Parts.....	56
Mega-Vendor Planogram	55
Raddatz	57
Deals	
Five Column.....	115
Single Column.....	114
Three Column.....	115
Vender Decals & Overlays	50, 104-113
Vender Lock.....	404
Vender Parts	
Kleen-Vend.....	51
Kleen-View	50
Laurel	46-49
Mega-Vendor®.....	56
Vending Kits.....	44, 45
Vending Supplies/Air Fresheners	
ArmorAll®.....	60-61, 88
Arm & Hammer™.....	99-100
Axe	89
Black Jack	63
Blue Magic®.....	63-64
Big Boss.....	68
Bomb Air Fresheners™.....	96
Bug & Tar Remover	63
California Scents®.....	92-93
Car-Freshner®.....	79-87
Character Air Fresheners	78
Citrus Magic®.....	101
Condoms.....	66
Dashwipe.....	66
Dakota Products	103
Detailing Diaper.....	76
Dog/Pet Wash	116, 458
Driven™.....	88
Febreze®Car™.....	98
Four Peaks®.....	64
Giant.....	74
Glass Cleaner Foam	62
Jenray™.....	94-95
Just For Leather.....	64
Keystone Scents	103
Kleen-Rite Towels.....	67-70
Laundry Vending.....	117-118, 744, 745, 751
Leather Chamois Sponge.....	73
Little Trees®.....	79-85
Magna Shine.....	66
Microfiber Vend Packs.....	75
Moistwipe Window Wipe	74
Mothers®.....	62
Never Fog.....	63
Nu-Towel/Sham.....	71
Original Shammy.....	55, 65, 116
Ozium®.....	97
Pet Wash	116, 458
Plasticolor.....	78
Quick Dry®.....	75-77
RainWipes®.....	73
Refresh Your Car®.....	90-91
Scents™.....	97
Scent Stones.....	103
Simoniz®.....	59
Sprayway®.....	62
Spritz-It.....	76
Truck Towel.....	67
Towels.....	67-76
Towels by Doctor Joe®.....	68
Vent Stone®.....	103
Wet Towels.....	72
Yankee Candle	102
Versamatic® Pumps.....	245
Versamatic® Manifolds.....	245

W

Walkie-Talkies.....	413
Wall Cleaners	
AP Formulations.....	714
Brick Renew	714
It Works!.....	472, 714
Klean Wall	472, 714
Klean Wall II.....	472, 714
National Chemical	714
Simoniz®.....	715
Wall Mount	
Air Shammee.....	449, 450
Booms.....	415, 416, 446, 450
Flag Holder.....	420
Foam Unit	184
Hose Holder.....	374
Hose Reels	602
Lights	339-341
Low Pressure System	461
Mat Clamps	393
Pressure Washers.....	585, 587
Sink	369
Spot Free Systems.....	478
Tanks.....	461, 560
Triple Foam Systems.....	461, 560
Vendor.....	57
Wand Holder.....	391
Water Softeners.....	476
Wall Panels Extrutech.....	472
Walters Float Valve.....	632
Wand Holders.....	391
Wands/Lances	
BE Pressure.....	589
Chrome Plated	387, 592, 594
Double Lance.....	386, 592
Economy Rubber Flex.....	388
Flexible.....	388
Galvanized.....	388, 594
General Pump®.....	386, 591, 592
Golden Gate.....	384, 388, 389
Gutter Cleaning.....	595
Hamel Manufacturing.....	387-389
Insulated.....	386
J.E. Adams.....	387, 592
Kleen-Rite.....	386, 593
Lightweight.....	386, 387, 389, 393, 592
Mosmatic.....	386, 592
Pressure Pro.....	594
Pressure Wash.....	592-595
Rubber Coated.....	387
Rubber Flex Wand™.....	388
Semi-Transparent.....	389
Smart Brush Handle.....	391
Spring Flex.....	388
Suttner.....	386, 593
Telescoping.....	591, 592
Tire Brush.....	384
Underbody.....	386
Value Line.....	389
Wand Pipes.....	387
Western Style.....	388
Wobblehead.....	391
Zinc Plated.....	388
Wash Down Motors.....	268
For Belanger®.....	527
For Hydro-Spray.....	503
Wash Mitts.....	176
Waste Receptacles	
Smoker's.....	333, 739
Trash.....	332, 333, 740
Water Based Hydraulic Fluid.....	269
Water Broom.....	591
Water Hardness Test Kit.....	717
Water Heaters	
Infiniti®.....	481
Valve Kit.....	481
Water Softeners	
GinSan.....	476
Pro Power.....	477, 478
Watts®	
Backflow Preventer.....	633
Float Valves.....	633
Regulators.....	252
Wax Applicators.....	160
Wax (Chemical)	
National Chemical.....	708
Simoniz®.....	147, 452, 474, 693
Shore.....	713, 714
TransMate™.....	704
Wax (Detail)	
Meguiars®.....	153
Mothers®.....	134
Simoniz®.....	142, 147
Wax (Retail)	

Armor All®.....	123, 124
Meguiars®.....	127, 128, 130, 131
Mothers®.....	134-136
Weep Mizer.....	460
Weiler Brush	
Bi-Level.....	402
Brush Handles.....	182, 403
Bus.....	402
Carpet/Upholstery.....	180
Heavy Duty.....	402
Palmyra.....	180, 402
Tampico.....	180, 402
Tire.....	180, 402
Truck.....	402
Wheelblaster Pro.....	565
Wheel Brush	
Detail/Dual Ended.....	180
Erie.....	567
Sonny's®.....	523
Universal.....	396, 567
Wheel Wonder®.....	567
White Wall Brush.....	180, 402
White Wall Cleaner (Chemicals).....	144, 689, 698
Windmaster Sign Holder.....	424, 685
Windmaster Sign Inserts.....	425-428, 685, 694, 701
Window/Glass Cleaner	
Chemicals	
Kleen-Shine™.....	143, 146
National Automotive Chemical.....	707
Meguiar's®.....	151
Mothers®.....	150
Simoniz®.....	700
Decals.....	106, 107, 108, 109, 111, 112
Detail/Retail	
Armor All®.....	119, 123, 124
Kleen-Shine™.....	143, 146
Invisible Glass®.....	138, 155
Meguiar's®.....	129, 151
Mothers®.....	135, 150
Simoniz®.....	139
Sprayway®.....	132
Stoner.....	138, 155
Towels.....	33-35
Vending	
Armor All®.....	61
Blue Magic®.....	63
Four Peaks®.....	64
Mothers®.....	62
Promo Car Care.....	66
Simoniz®.....	59
Sprayway®.....	62
Quick-Dry®.....	77
Window Marker.....	160
Window Washer Cloth/Foam.....	574
Windshield Wiper Bags.....	164
Wringers (hand).....	369
Wobble Head.....	391
Winter Anti-Freeze Chemicals	
JBS®.....	688
Kleen-Rite.....	688
Simoniz®.....	688

X

X-Jet	
Adjustable Downstream Nozzle.....	599, 613
Adjustable Injector Kit.....	613
Fixed Injector Kit.....	613
Parts.....	613
Xeptor (Hawk-MA850).....	359
Xeptor (Hawk-Mark).....	359

Y

Yamada®.....	248-249
Y-Type Strainer.....	266

Z

Zierden	
Booms.....	418
Conversion Kits.....	418
Swivel Cartridge.....	418



SHOP ONLINE

kleenrite.com

- ✓ **Live Chat:** Connect right online with our team of car wash experts!
- ✓ **Convenient Check Out:** Our easy one page check out process fast and simple.
- ✓ **Favorites List:** Create and shop from your own list of your favorite products.
- ✓ **Video Library:** Over 150 car wash videos showing you repairs, installations and new products.
- ✓ **Resource Library:** Our library of pump breakdowns, wiring diagrams, SDS sheets and more.
- ✓ **FAQ:** Each product has a Frequently Asked Questions Tab, where you can post questions.

KLEEN-RITE CORP.

257 South 9th Street/PO Box 886
Columbia PA 17512

BOUND PRINTED MATTER
US POSTAGE PAID
LANCASTER, PA
PERMIT #1018

GET YOUR ORDER
FAST!

Now Shipping From:
**MISSOURI, NEVADA,
TEXAS & PENNSYLVANIA!**

